

ENGLISH Read **Safety and Reference**.
ESPAÑOL Leer **Seguridad y Consultas**.
FRANÇAIS Lisez **Sécurité et références**.

ENGLISH
Easy Setup Guide
Please read this manual carefully before operating your set and retain it for future reference.

ESPAÑOL
Guía Rápida de Configuración
Lea atentamente este manual antes de poner en marcha el equipo y consérvelo para futuras consultas.

FRANÇAIS
Guide de configuration rapide
Avant d'utiliser l'appareil, veuillez lire attentivement ce manuel et le conserver pour pouvoir vous y reporter ultérieurement.

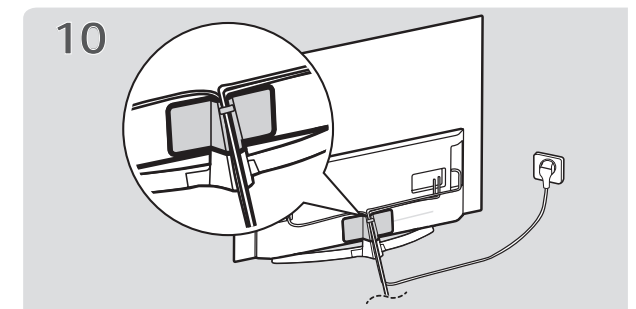
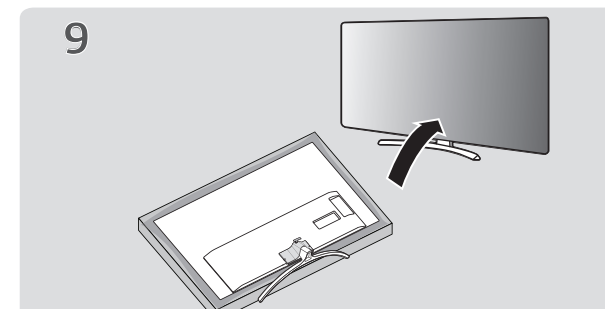
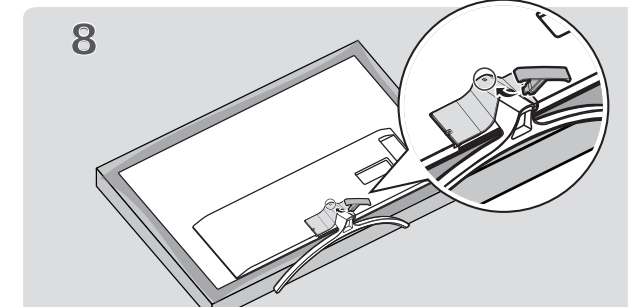
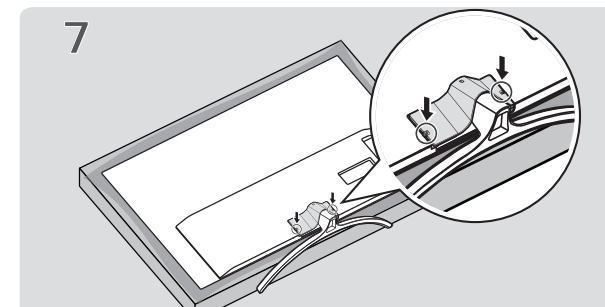
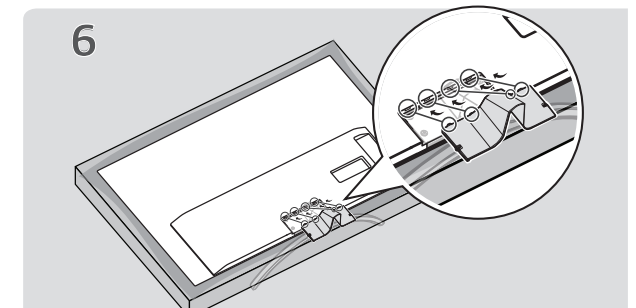
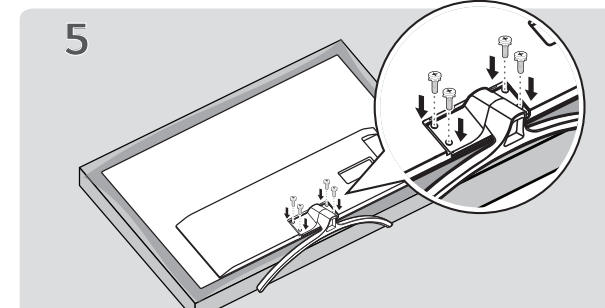
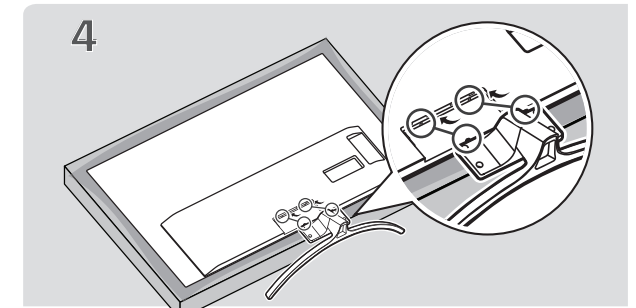
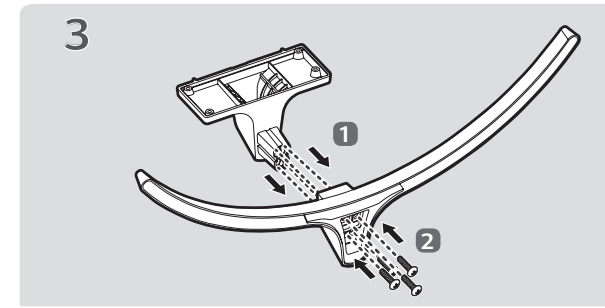
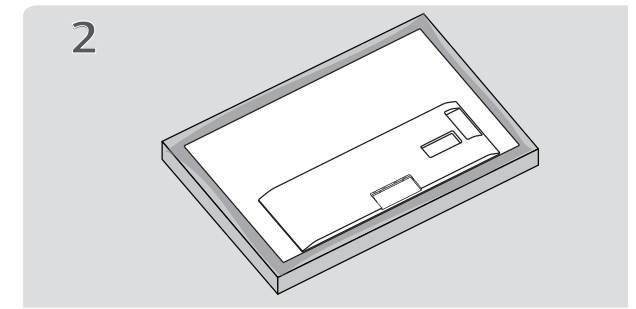
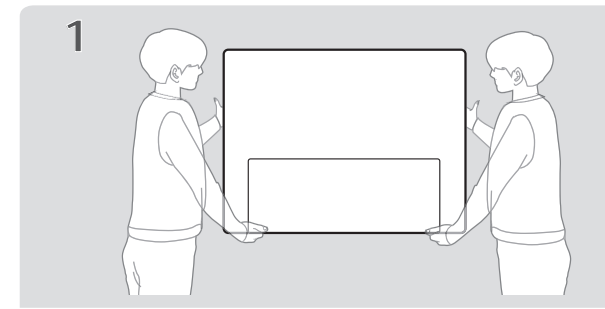

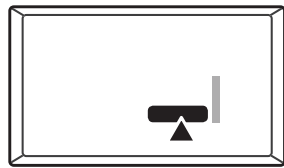

AUDIO OUT/
H/P OUT

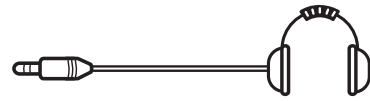

AV IN

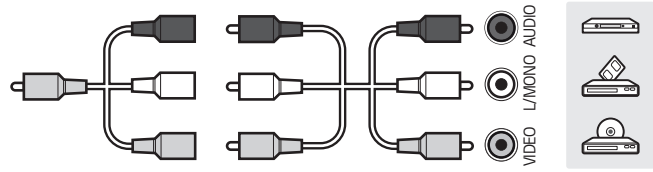

OPTICAL DIGITAL
AUDIO OUT

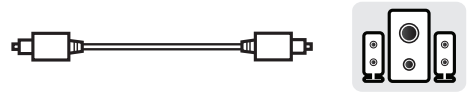

LAN

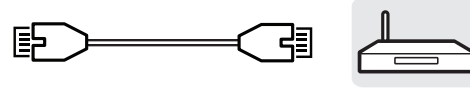

ANTENNA/
CABLE IN

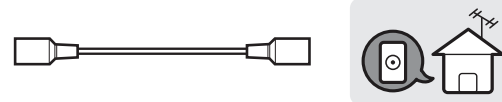

HDMI IN



USB IN



www.lg.com/us/support

ENGLISH
Easy TV Connect Guide
(Animation)

ESPAÑOL
Guía Rápida de Conexión del
televisor
(Sólo en Inglés)

FRANÇAIS
Guide simplifié pour la con-
nexion du téléviseur (Offert
en anglais seulement)



HDMI IN



HDMI IN/ARC

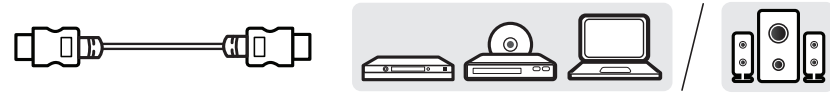

USB IN

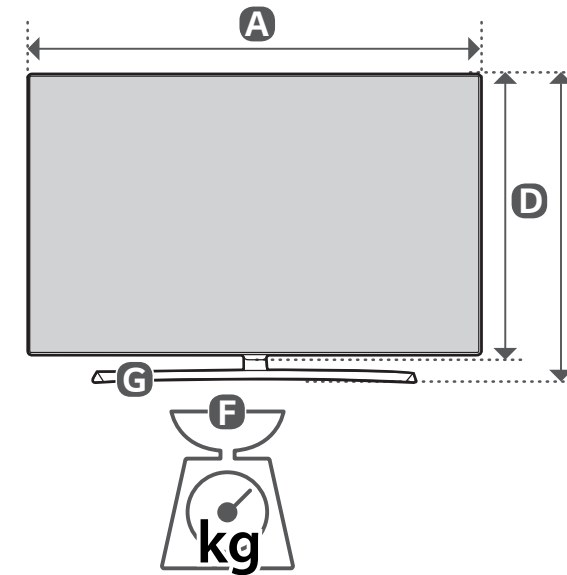
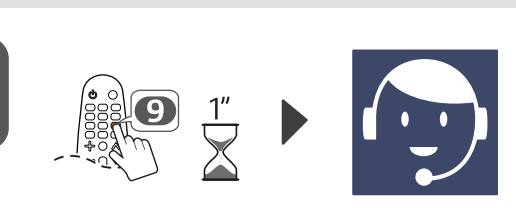
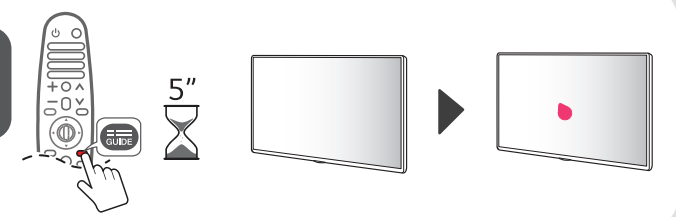
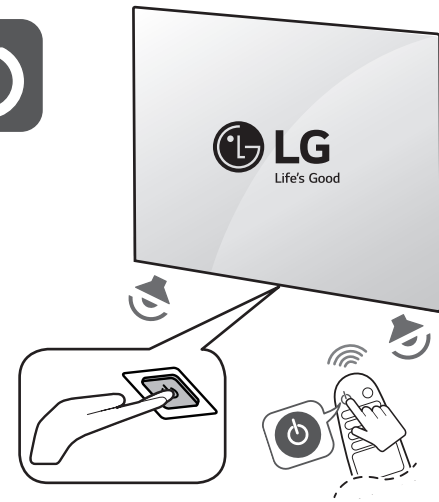
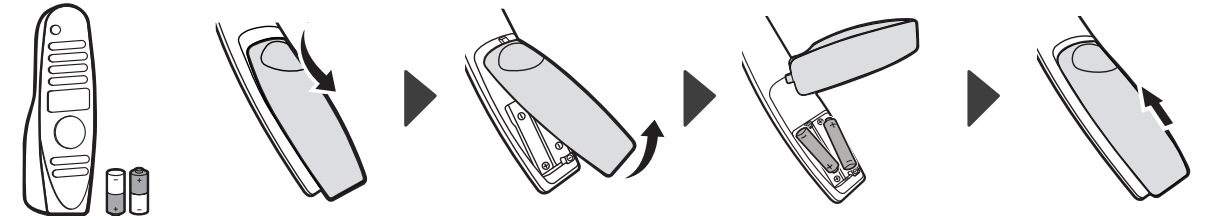

90°

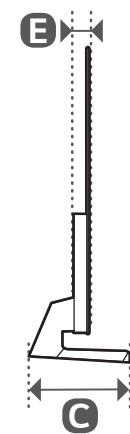

MODELS / MODELOS / MODÈLES	A		B		C		D		E		F		F - G		Power consumption / Consumo de potencia / Consommation électrique
	mm (inches / pulgadas / po)														
OLED55B9PUB	1,228 (48.3)	1 228 (48,3)	777 (30.5)	777 (30,5)	319 (12.5)	319 (12,5)	706 (27.7)	706 (27,7)	46.9 (1.8)	46,9 (1,8)	20.3 (44.7)	20,3 (44,7)	18.9 (41.6)	18,9 (41,6)	352 W
OLED65B9PUB	1,449 (57.0)	1 449 (57,0)	900 (35.4)	900 (35,4)	319 (12.5)	319 (12,5)	830 (32.6)	830 (32,6)	46.9 (1.8)	46,9 (1,8)	26.4 (58.2)	26,4 (58,2)	25.2 (55.5)	25,2 (55,5)	472 W
Power requirement / Alimentación requerida / Alimentation									AC 120 V- 50/60 Hz						