

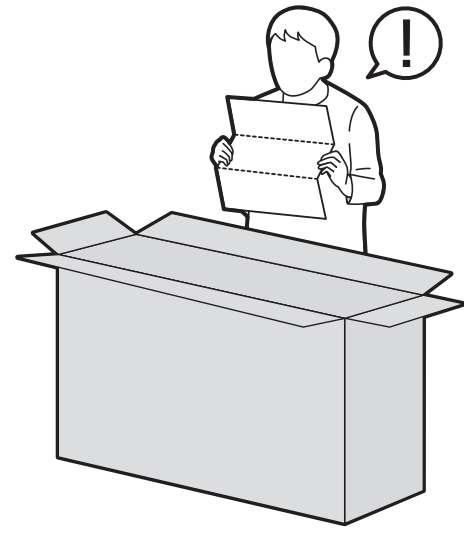

UQ70\*

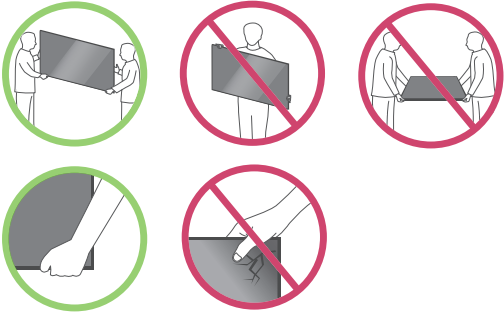

**1**  
43/50/55UQ70\*

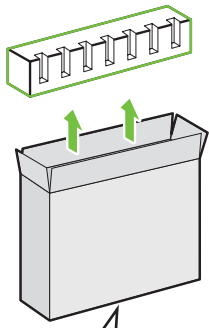

**2**

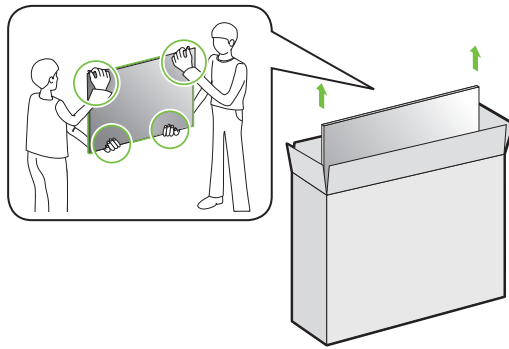

**3**

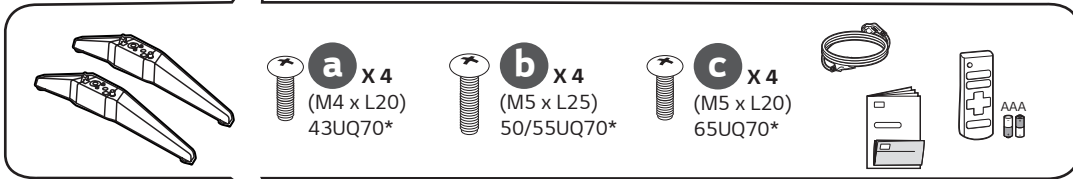
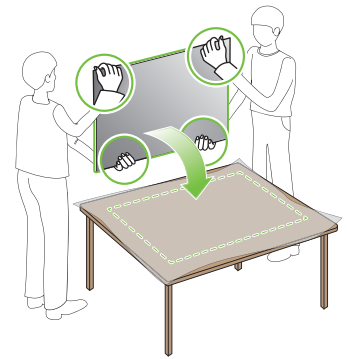

**1**  
65UQ70\*

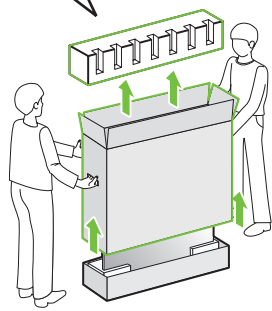

**2**

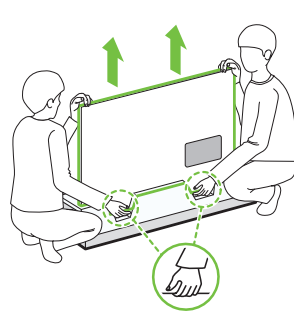

**3**

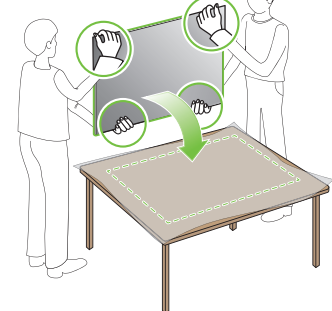

**1**

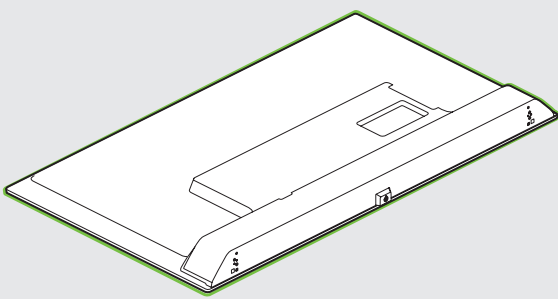

**2**

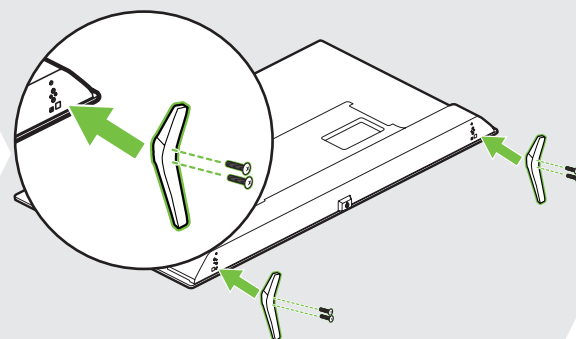

**3**

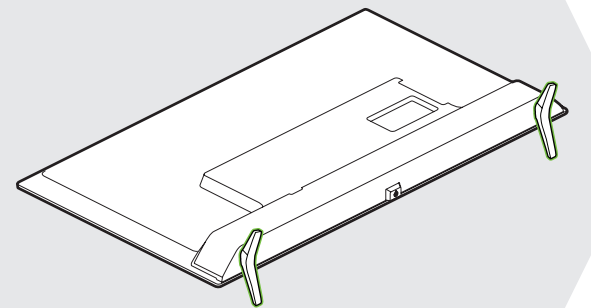

**4**

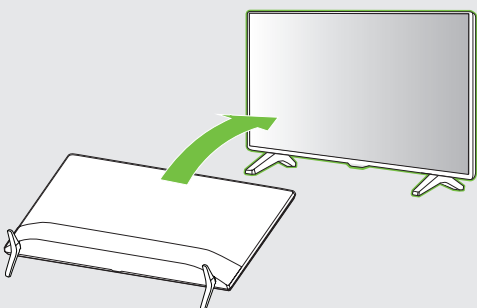

**5**

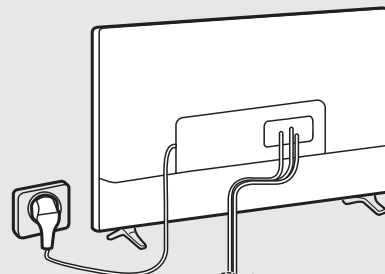

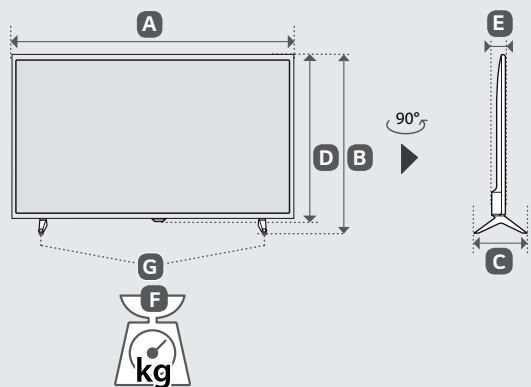
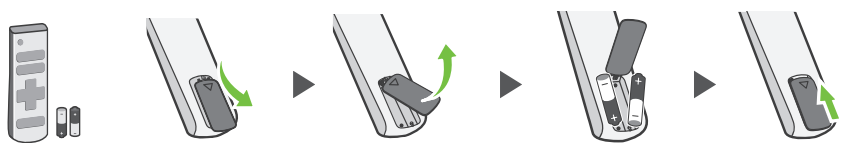
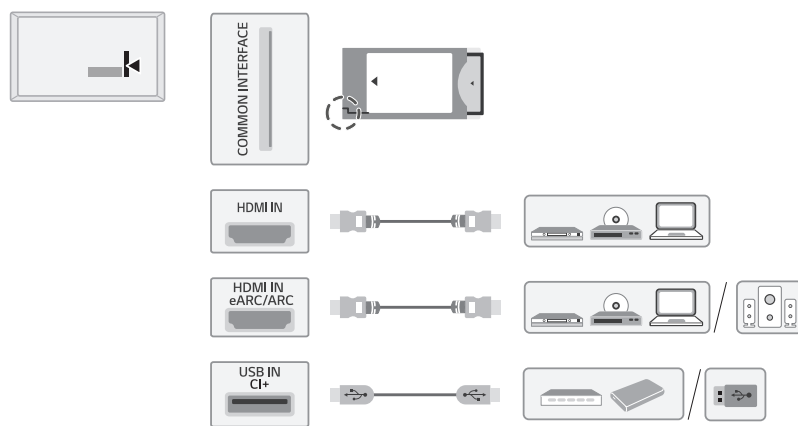
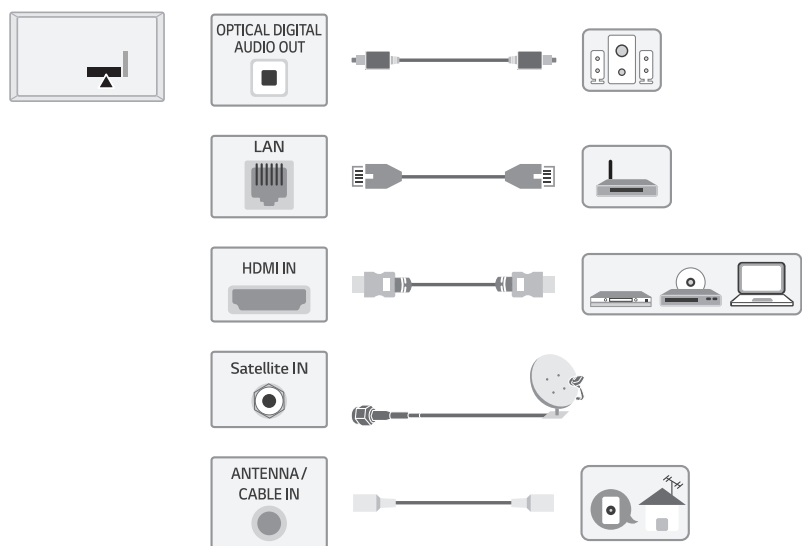

	A	B	C	D	E	F	F - G
	(mm)					(kg)	
43UQ70006LB 43UQ70003LB	967	616	219	567	88.1	7.2	7.1
50UQ70006LB 50UQ70003LB	1122	718	273	653	89.9	9.7	9.5
55UQ70006LB 55UQ70003LB	1236	784	273	718	89.9	11.4	11.2
65UQ70006LB 65UQ70003LB	1460	915	320	844	87.8	17.5	17.2
Power requirement			AC 110-240 V ~ 50 / 60 Hz				



English · Read **Safety and Regulatory**.

Deutsch · Lesen Sie die **Sicherheitsanweisungen und Richtlinien**.

Français · Lire le document **Sécurité et mesures réglementaires**.

Italiano · Leggere il manuale **Sicurezza e normative**.

Español · Leer **Seguridad y normativa**.

Português · Ler informações sobre a **Segurança e Regulamentos**.

Nederlands · **Veiligheidsinformatie en regelgeving** lezen.

Ελληνικά · Διαβάστε τις **οδηγίες για την ασφάλεια και τους κανονισμούς**.

Slovenščina · Preberite **varnostne in regulativne vidike**.

Hrvatski · Pročitajte **Sigurnost i usklađenost s propisima**.

Shqip · Lexoni paragrafin "**Siguria dhe rregullimi**".

Bosanski · Pročitajte dio **Sigurnost i propisi**.

Македонски · Прочитajte за **безбедноста и регулативата**.

Svenska · Läs **Säkerhet och föreskrifter**.

Magyar · Biztonsági szabályzat megtekintése.

Polski · Prosimy o przeczytanie **Zasad bezpieczeństwa i uwag dotyczących przepisów**.

Česky · Přečtěte si část **Bezpečnost a zákonné předpisy**.

Slovenčina · Prečítajte si **bezpečnostné a regulačné informácie**.

Română · Consultați manualul referitor la **siguranță și reglementare**.

Български · Прочетете **Безопасност и регулаторни стандарти**.

Eesti · Lugege **ohutus- ja normatiivteavet**.

Lietuvių k. · Perskaitykite **Saugos ir norminius reikalavimus**.

Latviešu · Izlasiet sadaļu **Drošība un normatīvi**.

Srpski · Pročitajte odeljak **Bezbednost i regulatorna pitanja**.

Norsk · Les **sikkerhet og forskrifter**.

Dansk · Læs **sikkerhed og lovmæssige bestemmelser**.

Suomi · Lue **Turvallisuus ja säännökset**-osio.

⊕ : Depending on model / Abhängig vom Modell / Selon le modèle / In base al modello / En función del modelo / Dependendo do modelo / Afhankelijk van het model / Av loyca με το μοντ λο / Odvisno od modela / Tipusfüggő / Zależnie od modelu / Závisí na modelu / V závislosti od modelu / În funcție de model / В зависимости от модели / Sõltub mudelist / Priklauso nuo modelio / Atkarībā no modeļa / U zavisnosti od modela / Ovisno o modelu / Në varësi të modelit / Ovisno o modelu / во зависност од моделот / Beroende på modell / Avhengig av modell / Afhængigt af modellen / Mallin mukaan