



INSTALLATION MANUAL

AIR-TO-WATER HEAT PUMP

Please read this installation manual completely before installing the product.
Installation work must be performed in accordance with the national wiring standards by authorized personnel only. Please retain this installation manual for future reference after reading it thoroughly.

THERMAV™

Original instruction



MFL68026607
Rev.21_022825

Copyright © 2018 - 2025 LG Electronics Inc. All Rights Reserved.

www.lg.com

PORTUGUÊS

ENGLISH

MAGYAR

ITALIANO

БЪЛГАРСКИ

ESPAÑOL

SRPSKI

FRANÇAIS

HRVATSKI

DEUTSCH

SLOVENŠČINA

EAHNIKA

DANSK

ČEŠTINA

NEDERLANDS

POLSKI

LIMBA ROMÂNĂ

TABLE OF CONTENTS

8 PREFACE

[Chapter 1]

9 SAFETY INSTRUCTIONS

[Chapter 2]

22 INSTALLATION PART

[Chapter 3]

23 GENERAL INFORMATION

- 23 Model Information
- 25 Model name and related information
- 26 Parts and Dimensions
- 32 Control Parts
- 34 Remote Controller
- 35 Typical Installation Example
- 41 Cycle Diagram
- 44 Water cycle

[Chapter 4]

47 INSTALLATION

- 47 Transporting the Unit
- 48 Installation places
- 48 Seasonal Wind and Cautions in Winter
- 49 Multiple installation
- 51 Installation at Seaside
- 52 Foundation for Installation
- 53 Electrical Wiring
- 63 Wiring of main power supply and equipment capacity

64	Water Piping and Water Circuit Connection
65	Pipe Insulation
66	Water Charging
67	Water pump Capacity
67	Pressure Drop
68	Performance curve
69	Water Quality
69	Frost protection by antifreeze
70	Frost protection by antifreeze valve
72	Water Volume and Expansion Vessel Pressure

[Chapter 5]

73 ACCESSORIES INSTALLATION

73	Accessories supported by LG Electronics
75	Accessories supported by 3rd party Companies
76	Before Installation
76	Thermostat
80	2nd Circuit
85	3rd Party Boiler
86	3rd Party Controller
87	Meter Interface
88	Central Controller
89	Remote Controller
93	DHW Tank
98	DHW Tank Kit
100	Solar Thermal Kit (For 3 Series)
102	Solar Thermal Kit (For 4 Series)
103	Dry Contact
105	External Controller - Setting up programmable digital input operation
106	Remote Temperature Sensor
109	Solar pump
110	External pump
111	Wi-fi Modem
112	Energy State
113	Digital Input for energy saving (ESS, Smart Grid)
114	2Way Valve

- 116 3Way Valve(A)
- 117 3Way Valve(B)
- 118 Electric Heater
- 124 Typical Installation Example
- 126 Final check

[Chapter 6]

127 CONFIGURATION

- 127 DIP Switch Setting

[Chapter 7]

137 SERVICE SETTING

- 137 How to enter service setting
- 137 Service setting
- 138 Service Contact
- 139 Model Information
- 140 RMC Version Information
- 141 Open Source License

[Chapter 8]

142 INSTALLER SETTING (For 3 Series)

- 142 How to enter installer setting
- 143 Installer setting (For 3 Series)
- 145 3 Minutes Delay
- 146 Select Temperature Sensor
- 147 Dry Contact Mode
- 148 Central Control Address
- 149 Pump test run
- 150 Air cooling set temp.
- 151 Water cooling set temp.
- 152 Air heating set temp.
- 153 Water heating set temp.
- 154 DHW set temp.

155	Screed drying
157	Heater on temperature
159	Water supply off temp. during cooling
161	Tank disinfection setting 1, 2
162	Tank setting1
163	Tank setting2
165	Heater priority
166	DHW time setting
168	TH on/off Variable, heating air
169	TH on/off Variable, heating water
170	TH on/off Variable, cooling air
171	TH on/off Variable, cooling water
172	Heating temp. setting
173	Cooling temp. setting
174	Pump setting in heating
175	Pump setting. in cooling
176	Forced operation
177	CN_CC
178	Pump Capacity
179	Seasonal auto temp.
181	Modbus Address
182	CN_EXT
183	Anti-freezing Temperature
184	Add Zone
185	Use External Pump
186	3rd Party Boiler
187	Meter Interface
188	Pump Prerun/Overrun
189	Solar Thermal System
191	Energy state
194	Data logging
195	Password Initialization

196 INSTALLER SETTING (For 4 Series)

199	Select Temperature Sensor
200	Use Heating Tank Heater
201	Mixing Circuit
204	Use External Pump

205	RMC master/slave
206	LG Therma V Configuration
207	Forced operation
208	Pump Prerun/Overrun
209	Water Flow Control
210	Energy Monitoring
211	Anti-Freezing Option 1
212	Password Reset
213	Screed drying
215	Heater on temperature
216	Air heating set temp.
217	Water heating set temp.
218	Hysteresis Room Air(Heating)
219	Hysteresis Heating Water
220	Heating temp. setting
221	Pump setting in heating
222	Air cooling set temp.
223	Water cooling set temp.
224	Water supply off temp. during cooling
225	Hysteresis Room Air(Cooling)
226	Hysteresis Cooling Water
227	Cooling temp. setting
228	Pump setting in cooling
229	Seasonal auto temp.
232	Heater priority
233	DHW set temp.
234	Tank disinfection setting 1, 2
235	Tank setting1
236	Tank setting2
238	DHW time setting
240	Recirculation time
241	Solar Thermal System
243	Pump test run
244	Frost Protection Temp.
245	Dry Contact Mode
246	Central Control Address
247	CN_CC
248	LG Therma V Configuration

249	Energy state
252	Thermostat control type
253	Pump operation time
254	IDU operation time
255	Modbus Address
256	Modbus gateway memory map
259	CN_EXT
260	3rd Party Boiler
261	Meter Interface
262	Current flow rate
263	Data logging

[Chapter 9]

264 COMMISSIONING

264	Check List before Starting Operation
265	Starting Operation
266	Starting Operation flow chart
266	Airborne Noise Emission
267	Vacuum & Charge of Refrigerant
269	How to drain remaining water in the product
270	Troubleshooting





PREFACE

This installation manual is to present information and guide about understanding, installing, and checking **THERMAV**.

Your careful reading before installation is highly appreciated to make no mistake and to prevent potential risks. The manual is divided into nine chapters. These chapters are classified according to installation procedure. See the table below to get summarized information.

Chapters	Contents
Chapter 1	<ul style="list-style-type: none"> • Warning and Caution concerned with safety. • This chapter is directly related with human safety. We strongly recommend reading this chapter carefully.
Chapter 2	<ul style="list-style-type: none"> • Items Inside product Box • Before starting installation, please make it sure that all parts are found inside the product box.
Chapter 3	<ul style="list-style-type: none"> • Fundamental knowledge about THERMAV. • Model identification, accessories information, refrigerant and water cycle diagram, parts and dimensions, electrical wiring diagrams, etc. • This chapter is important to understand THERMAV.
Chapter 4	<ul style="list-style-type: none"> • Installation about the unit. • Installation location, constraints on installation site, etc • Electrical wiring at the unit. • System set-up and configuration. • Information about water pump
Chapter 5	<ul style="list-style-type: none"> • Information about supported accessories • Specification, Constraints, and wiring are described. • Before purchasing accessories, please find supported specification to buy proper one.
Chapter 6	<ul style="list-style-type: none"> • Information about DIP switch setting
Chapter 7	<ul style="list-style-type: none"> • check and input service contact • information about model and open source license
Chapter 8	<ul style="list-style-type: none"> • Information on the installer setup mode that sets the detailed functions of the remote control • Incorrectly setting the installer setup mode may result in product failure, personal injury, or property loss, so this chapter requires a deeper understanding
Chapter 9	<ul style="list-style-type: none"> • Check points before starting operation are explained. • Troubleshooting, maintenance, and error code list are presented to correct problems

SAFETY INSTRUCTIONS

	<p>Read the precautions in this manual carefully before operating the unit.</p>		<p>This appliance is filled with flammable refrigerant (for R32)</p>
	<p>This symbol indicates that the Operation Manual should be read carefully.</p>		<p>This symbol indicates that a service personnel should be handling this equipment with reference to the Installation Manual.</p>

The following safety guidelines are intended to prevent unforeseen risks or damage from unsafe or incorrect operation of the appliance. The guidelines are separated into 'WARNING' and 'CAUTION' as described below.

 This symbol is displayed to indicate matters and operations that can cause risk. Read the part with this symbol carefully and follow the instructions in order to avoid risk.

WARNING

This indicates that the failure to follow the instructions can cause serious injury or death.

CAUTION

This indicates that the failure to follow the instructions can cause the minor injury or damage to the product.

WARNING

Installation

- Do not use a defective or underrated circuit breaker. Use this appliance on a dedicated circuit.
 - There is risk of fire or electric shock.

- For electrical work, contact the dealer, seller, a qualified electrician, or an Authorized Service Center.
 - There is risk of fire or electric shock.
- Always ground the unit.
 - There is risk of fire or electric shock.
- Install the panel and the cover of control box securely.
 - There is risk of fire or electric shock.
- Always install a dedicated circuit and breaker.
 - Improper wiring or installation may cause fire or electric shock.
- Use the correctly rated breaker or fuse.
 - There is risk of fire or electric.
- Do not modify or extend the power cable.
 - There is risk of fire or electric shock.
- Do not install, remove, or reinstall the unit by yourself (customer).
 - There is risk of fire, electric shock, explosion, or injury
- For antifreeze, always contact the dealer or an authorized service center.
 - Almost the antifreeze is a toxic product.
- For installation, always contact the dealer or an authorized Service Center.
 - There is risk of fire, electric shock, explosion, or injury.
- Do not install the unit on a defective installation stand.
 - It may cause injury, accident, or damage to the unit.
- Be sure the installation area does not deteriorate with age.
 - If the base collapses, the unit could fall with it, causing property damage, unit failure, and personal injury.
- Do not install the water pipe system as Open loop type.
 - It may cause failure of unit.

- Use a vacuum pump or inert (nitrogen) gas when doing leakage test or purging air. Do not compress air or oxygen and do not use flammable gases.
 - There is the risk of death, injury, fire or explosion.
- Make sure the connected condition of connector in product after maintenance.
 - Otherwise, it may cause product damage.
- Do not touch leaked refrigerant directly.
 - There is risk of frostbite.
- Copper in contact with refrigerants shall be oxygen-free or deoxidized, for example Cu-DHP as specified in EN 12735-1 and EN 12735-2.
- Compliance with national gas regulations shall be observed. (for R32)
- Refrigerant tubing shall be protected or enclosed to avoid damage. (for R32)
- The installation of pipe-work shall be kept to a minimum. (for R32)
- A brazed, welded, or mechanical connection shall be made before opening the valves to permit refrigerant to flow between the refrigerating system parts. A vacuum valve shall be provided to evacuate the interconnecting pipe and/or any uncharged refrigerating system part. (for R32)
- Any person who is involved with working on or breaking into a refrigerant circuit should hold a current valid certificate from an industry-accredited assessment authority, which authorises their competence to handle refrigerants safely in accordance with an industry recognised assessment specification. (for R32)
- Do not use means to accelerate the defrosting process or to clean, other than those recommended by the manufacturer. (for R32)

- Do not pierce or burn. (for R32)
- Be aware that refrigerants may not contain an odour. (for R32)
- Dismantling the unit, treatment of the refrigerant oil and eventual parts should be done in accordance with local and national standards. (for R32)
- Flexible refrigerant connectors (such as connecting lines between the indoor and outdoor unit) that may be displaced during normal operations shall be protected against mechanical damage. (for R32)
- Pipe-work shall be protected from physical damage. (for R32)
- Mechanical connections (mechanical connectors or flared joints) shall be accessible for maintenance purposes. (for R32)
- Ventilated area
Ensure that the area is in the open or that it is adequately ventilated before breaking into the system or conducting any hot work. A degree of ventilation shall continue during the period that the work is carried out. The ventilation should safely disperse any released refrigerant and preferably expel it externally into the atmosphere.
- Cabling
Cabling will not be subject to wear, corrosion, excessive pressure, vibration, sharp edges or any other adverse environmental effects. The check shall also take into account the effects of aging or continual vibration from sources such as compressors or fans.

Operation

- Take care to ensure that power cable could not be pulled out or damaged during operation.
 - There is risk of fire or electric shock.

- Do not place anything on the power cable.
 - There is risk of fire or electric shock.
- Do not plug or unplug the power supply plug during operation.
 - There is risk of fire or electric shock.
- Do not touch (operate) the unit with wet hands.
 - There is risk of fire or electric shock.
- Do not place a heater or other appliances near the power cable.
 - There is risk of fire or electric shock.
- Do not allow water to run into electric parts.
 - There is risk of fire, failure of the unit, or electric shock.
- Do not store or use flammable gas or combustibles near the unit.
 - There is risk of fire or failure of unit.
- Do not use the unit in a tightly closed space for a long time.
 - It may cause damage to the unit.
- When flammable gas leaks, turn off the gas and open a window for ventilation before turning the unit on.
 - There is risk of explosion or fire.
- If strange sounds, or smell or smoke comes from unit, turn the breaker off or disconnect the power supply cable.
 - There is risk of electric shock or fire.
- Stop operation and close the window in storm or hurricane. If possible, remove the unit from the window before the hurricane arrives.
 - There is risk of property damage, failure of unit, or electric shock.
- Do not open the front cover of the unit while operation. (Do not touch the electrostatic filter, if the unit is so equipped.)
 - There is risk of physical injury, electric shock, or unit failure.

- Do not touch any electric part with wet hands. you should be power off before touching electric part.
 - There is risk of electric shock or fire.
- Do not touch refrigerant pipe and water pipe or any internal parts while the unit is operating or immediately after operation.
 - There is risk of burns or frostbite, personal injury.
- If you touch the pipe or internal parts, you should be wear protection or wait time to return to normal temperature.
 - Otherwise , it may cause burns or frostbite, personal injury.
- Turn the main power on 6 hours ago before the product starting operation.
 - Otherwise, it may cause compressor damage.
- Do not touch electric parts for 10 minutes after main power off.
 - There is risk of physical injury, electric shock.
- The inside heater of product may operate during stop mode. It is intended to protect the product.
- Be careful that some part of the control box are hot.
 - There is risk of physical injury or burns.
- When the unit is soaked (flooded or submerged), contact an Authorized Service Center.
 - There is risk of fire or electric shock.
- Be cautious that water could not be poured to the unit directly.
 - There is risk of fire, electric shock, or unit damage.
- Ventilate the unit from time to time when operating it together with a stove, etc.
 - There is risk of fire or electric shock.
- Turn the main power off when cleaning or maintaining the unit.
 - There is risk of electric shock.
- Take care to ensure that nobody could step on or fall onto the unit.
 - This could result in personal injury and unit damage.

- If the unit is not used for long time, we strongly recommend not to switch off the power supply to the unit.
 - There is risk of water freezing.
- The appliance shall be stored in a well-ventilated area where the room size corresponds to the room area as specified for operation. (for R32)
- The appliance shall be stored in a room without continuously operating open flames (for example an operating gas appliance) and ignition sources (for example an operating electric heater). (for R32)
- The appliance shall be stored so as to prevent mechanical damage from occurring. (for R32)
- Servicing shall only be performed as recommended by the equipment manufacturer. Maintenance and repair requiring the assistance of other skilled personnel shall be carried out under the supervision of the person competent in the use of flammable refrigerants. (for R32)
- When mechanical connectors are reused indoors, sealing parts shall be renewed. When flared joints are reused indoors, the flare part shall be re-fabricated. (for R32)
- Periodic (more than once/year) cleaning of the dust or salt particles stuck on the heat exchangers by using water. (for R32)
- Keep any required ventilation openings clear of obstruction. (for R32)

Repair

• **Detection of flammable refrigerants**

Under no circumstances shall potential sources of ignition be used in the searching for or detection of refrigerant leaks.

A halide torch (or any other detector using a naked flame) shall not be used.

- **Leak detection methods**

The following leak detection methods are deemed acceptable for systems containing flammable refrigerants. Electronic leak detectors shall be used to detect flammable refrigerants, but the sensitivity may not be adequate, or may need re-calibration. (Detection equipment shall be calibrated in a refrigerant-free area.) Ensure that the detector is not a potential source of ignition and is suitable for the refrigerant used. Leak detection equipment shall be set at a percentage of the LFL of the refrigerant and shall be calibrated to the refrigerant employed and the appropriate percentage of gas (25 % maximum) is confirmed.

Leak detection fluids are also suitable for use with most refrigerants but the use of detergents containing chlorine shall be avoided as the chlorine may react with the refrigerant and corrode the copper pipe-work.

NOTE

Examples of leak detection fluids are

- Bubble method
- Fluorescent method agents

If a leak is suspected, all naked flames shall be removed/extinguished. If a leakage of refrigerant is found which requires brazing, all of the refrigerant shall be recovered from the system, or isolated (by means of shut off valves) in a part of the system remote from the leak. Removal of refrigerant shall be according to removal and evacuation procedure.

- **Charging procedures**

In addition to conventional charging procedures, the following requirements shall be followed.

- Ensure that contamination of different refrigerants does not occur when using charging equipment. Hoses or lines shall be as short as possible to minimise the amount of refrigerant contained in them.

- Cylinders shall be kept in an appropriate position according to the instruction.
- Ensure that the refrigeration system is earthed prior to charging the system with refrigerant.
- Label the system when charging is complete (if not already).
- Extreme care shall be taken not to overfill the refrigerating system. Prior to recharging the system, it shall be pressure tested with the appropriate purging gas.
The system shall be leak-tested on completion of charging but prior to commissioning. A follow up leak test shall be carried out prior to leaving the site.

- **Recovery**

When removing refrigerant from a system, either for servicing or decommissioning, it is recommended good practice that all refrigerants are removed safely.

When transferring refrigerant into cylinders, ensure that only appropriate refrigerant recovery cylinders are employed.

Ensure that the correct number of cylinders for holding the total system charge are available.

All cylinders to be used are designated for the recovered refrigerant and labelled for that refrigerant (i.e. special cylinders for the recovery of refrigerant).

Cylinders shall be complete with pressure relief valve and associated shut-off valves in good working order.

Empty recovery cylinders are evacuated and, if possible, cooled before recovery occurs.

The recovery equipment shall be in good working order with a set of instructions concerning the equipment that is at hand and shall be suitable for the recovery of flammable refrigerants. In addition, a set of calibrated weighing scales shall be available and in good working order.

Hoses shall be complete with leak-free disconnect couplings and in good condition. Before using the recovery machine, check that it is in satisfactory working order, has been properly maintained and that any associated electrical components are sealed to prevent ignition in the event of a refrigerant release. Consult manufacturer if in doubt.

The recovered refrigerant shall be returned to the refrigerant supplier in the correct recovery cylinder, and the relevant Waste Transfer Note arranged.

Do not mix refrigerants in recovery units and especially not in cylinders. If compressors or compressor oils are to be removed, ensure that they have been evacuated to an acceptable level to make certain that flammable refrigerant does not remain within the lubricant.

The evacuation process shall be carried out prior to returning the compressor to the suppliers.

Only electric heating to the compressor body shall be employed to accelerate this process. When oil is drained from a system, it shall be carried out safely.

- **Removal and evacuation**

When breaking into the refrigerant circuit to make repairs – or for any other purpose – conventional procedures shall be used. However, for flammable refrigerants it is important that best practice is followed since flammability is a consideration.

The following procedure shall be adhered to:

- Remove refrigerant;
- Purge the circuit with inert gas (optional for A2L);
- Evacuate (optional for A2L);
- Purge with inert gas (optional for A2L);
- Open the circuit by cutting or brazing

The refrigerant charge shall be recovered into the correct recovery cylinders. For appliances containing flammable refrigerants other than A2L refrigerants, the system shall be purged with oxygen-free nitrogen to render the appliance safe for flammable refrigerants. This process may need to be repeated several times.

Compressed air or oxygen shall not be used for purging refrigerant systems.

For appliances containing flammable refrigerants, other than A2L refrigerants, refrigerants purging shall be achieved by breaking the vacuum in the system with oxygen-free nitrogen and continuing to fill until the working pressure is achieved, then venting to atmosphere, and finally pulling down to a vacuum. This process shall be repeated until no refrigerant is within the system. When the final oxygen-free nitrogen charge is used, the system shall be vented down to atmospheric pressure to enable work to take place. This operation is absolutely vital if brazing operations on the pipe-work are to take place. Ensure that the outlet for the vacuum pump is not close to any potential ignition sources and that ventilation is available.

CAUTION

Installation

- Always check for gas (refrigerant) leakage after installation or repair of unit.
 - Low refrigerant levels may cause failure of unit.
- Keep level even when installing the unit.
 - To avoid vibration or water leakage.
- Use two or more people to lift and transport the unit.
 - Avoid personal injury.

- In order to avoid a hazard due to inadvertent resetting of the thermal cut-out, this appliance must not be supplied through an external switching device, such as a timer, or connected to a circuit that is regularly switched on and off by the utility.
- Do not install the unit in potentially explosive atmospheres.
- The water may drip from the discharge pipe of the pressure-relief device and that this pipe must be left open to the atmosphere.
- The pressure-relief device is to be operated regularly to remove lime deposits and to verify that it is not blocked.
- A discharge pipe connected to the pressure-relief device is to be installed in a continuously downward direction and in a frost-free environment.

Operation

- Do not use the unit for special purposes, such as preserving foods, works of art, etc.
 - There is risk of damage or loss of property.
- Use a soft cloth to clean. Do not use harsh detergents, solvents, etc.
 - There is risk of fire, electric shock, or damage to the plastic parts of the unit.
- Do not step on or put anything on the unit.
 - There is risk of personal injury and failure of unit.
- Use a firm stool or ladder when cleaning or maintaining the unit.
 - Be careful and avoid personal injury.
- Do not turn on the breaker or power under condition that front panel cabinet, top cover, control box cover are removed or opened.
 - Otherwise it may cause fire, electric shock, explosion or death.





- The appliance shall be disconnected from its power source during service and when replacing parts.
- Means for disconnection must be incorporated in the fixed wiring in accordance with the wiring rules.
- The Installation kit supplied with the appliance are to be used and that old Installation kit should not be reused.
- If the supply cord is damaged, it must be replaced by the manufacturer, its service agent or similarly qualified persons in order to avoid a hazard. Installation work must be performed in accordance with the national wiring standards by authorized personnel only.
- This equipment shall be provided with a supply conductor complying with the national regulation.
- The instructions for service to be done by specialized personnel, mandated by the manufacturer or the authorized representative may be supplied in only one Community language which the specialized personnel understand.
- This appliance is not intended for use by persons (including children) with reduced physical, sensory or mental capabilities or lack of experience and knowledge, unless they have been given supervision or instruction concerning use of the appliance by a person responsible for their safety. Children should be supervised to ensure that they do not play with the appliance.

INSTALLATION PART

Thank you for choosing LG Electronics Air-to-Water Heat Pump **THERMAV.**

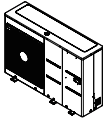
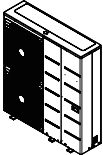
Before starting installation, please make it sure that all parts are found inside the product box.

*The parts can be found inside the outdoor unit by opening the side panel.

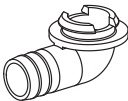
Item	Image
Installation Manual	
Outdoor Unit UN36A Chassis (Product heating capacity : 5, 7, 9 kW)	
Outdoor Unit UN60A Chassis (Product heating capacity : 9, 12, 14, 16 kW)	
Remote Controller	
Remote Controller Cable (Default length : 10 m)	
Damper (x 6)	
Drain Cap (x 6)	
Drain Nipple	

GENERAL INFORMATION

With advanced inverter technology, **THERMAV** is suitable for applications like under floor heating, under floor cooling, and hot water generation. By Interfacing to various accessories user can customize the range of the application.

In this chapter, general information of **THERMAV** is presented to identify the installation procedure. Before beginning installation, read this chapter carefully and find helpful information on installation.

Model Information

Factory Model Name

Model	No.						
	1	2	3	4	5	6	7
Monobloc	ZH	B	W	09	6	A	0

No.	Signification
1	Air-to-Water-Heat Pump for R32
2	Classification - B : Monobloc
3	Model Type - W : Inverter Heat Pump
4	Heating Capacity - E.g) 9 kW → '09'
5	Electrical ratings - 6 : 1 phase 220-240 V~ 50 Hz - 8 : 3 phase 380-415 V~ 50 Hz
6	Function - A : General heating heat pump
7	Series Number

Buyer Model Name

- For 3 Series

Refrigerant	No.						
	1	2	3	4	5	7	8
R32	H	M	09	1	M	U3	3

No.	Signification
1	Air-to-Water-Heat Pump
2	Classification - M : Monobloc
3	Heating Capacity - E.g) 9 kW → '09'
4	Electrical ratings - 6 : 1 phase 220-240 V~ 50 Hz - 8 : 3 phase 380-415 V~ 50 Hz
5	Leaving Water Combination - M : Middle Temperature
6	Chassis Name - U3 : UN60A Chassis - U4 : UN36A Chassis
7	Series Number

- For 3 Series

Refrigerant	No.								
	1	2	3	4	5	6	7	8	9
R32	H	M	09	1	M	R	S	U3	3

No.	Signification
1	Air-to-Water-Heat Pump
2	Classification - M : Monobloc
3	Heating Capacity - E.g) 9 kW → '09'
4	Electrical ratings - 6 : 1 phase 220-240 V~ 50 Hz - 8 : 3 phase 380-415 V~ 50 Hz
5	Leaving Water Combination - M : Middle Temperature
6	Refrigerant - R : R32
7	Function - S : Silent
8	Chassis Name - U3 : UN60A Chassis - U4 : UN36A Chassis
9	Series Number

- For 4 Series

Refrigerant	No.							
	1	2	3	4	5	6	7	8
R32	H	M	09	1	M	R	U3	4

No.	Signification
1	Air-to-Water-Heat Pump
2	Classification - M : Monobloc
3	Heating Capacity - E.g) 9 kW → '09'
4	Electrical ratings - 6 : 1 phase 220-240 V~ 50 Hz - 8 : 3 phase 380-415 V~ 50 Hz
5	Leaving Water Combination - M : Middle Temperature
6	Refrigerant - R : R32
7	Chassis Name - U3 : UN60A Chassis - U4 : UN36A Chassis
8	Series Number

Check the model information based on the buyer model series number.
(e.g., geometry, cycle, etc.)

- Additional Information : Serial number refers to the barcode on the product.
- Max allowable pressure High side : 4.32 MPa / Low side : 2.4 MPa

[Operating condition]

- Maximum operating temperature of water : 65 °C
- Minimum operating temperature of water : 15 °C
- Maximum inlet water pressure : 0.3 MPa
- Minimum inlet water pressure : 0.03 MPa

Model name and related information

Model Name		Capacity (kW)			Power Source (Unit)
Chassis	Phase(Ø)	Capacity(kW)	Heating ¹⁾	Cooling ²⁾	
UN36A	1	5	5.5	5.5	220-240 V~ 50 Hz
		7	7	7	
		9	9	9	
	3	9	9	9	380-415 V 3N~ 50 Hz
UN60A	1	9	9	9	220-240 V~ 50 Hz
		12	12	12	
		14	14	14	
		16	16	16	
	3	12	12	12	380-415 V 3N~ 50 Hz
		14	14	14	
		16	16	16	

1 : Tested under EN14511
(water temperature 30 °C → 35 °C at outdoor ambient temperature 7 °C / 6 °C)

2 : Tested under EN14511
(water temperature 23 °C → 18 °C at outdoor ambient temperature 35 °C / 24 °C)

* All appliances were tested at atmospheric pressure.

Parts and Dimensions

- For 3 Series

UN36A (5, 7, 9 kW)

(Unit : mm)

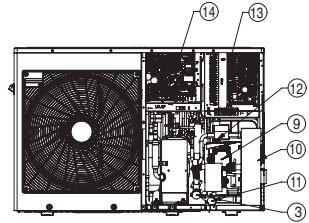
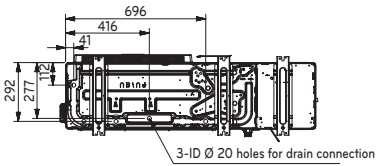
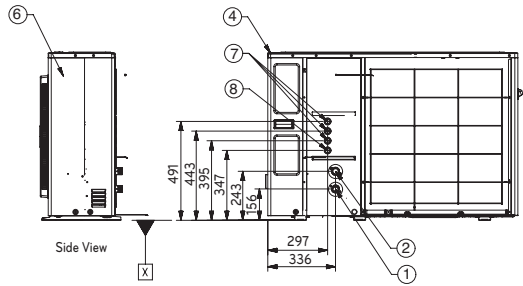
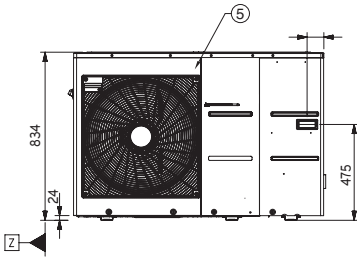
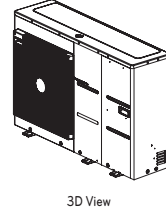
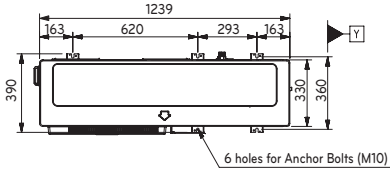

* The shape may differ depending on the model.

UN60A (9, 12, 14, 16 kW)

(Unit : mm)

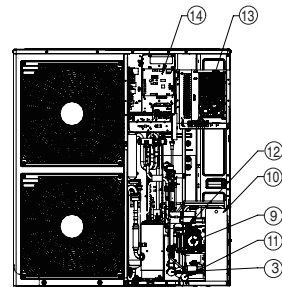
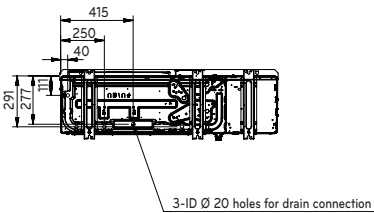
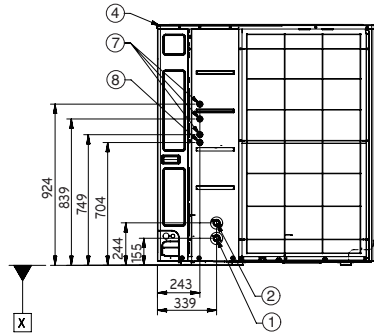
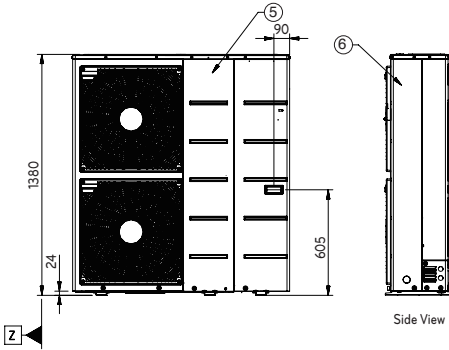
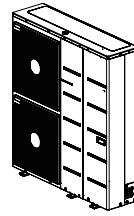
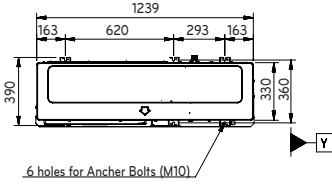

* The shape may differ depending on the model.

Description

No	Name	Remarks
1	Entering water pipe	Male PT 1 inch
2	Leaving water pipe	Male PT 1 inch
3	Strainer	Filtering and stacking particles inside circulating water
4	Top cover	-
5	Front Panel	-
6	Side Panel	-
7	Low Voltage	Communication Cable Hole
8	UNIT Power	Power Cable Hole
9	Water Pump	Circulating the water
10	Plate Heat Exchanger	Heat exchanger between refrigerant and water
11	Pressure Gage	Indicates circulating water pressure
12	Safety Valve	Open at Water pressure 3 bar
13	Heater Control Box	Heater PCB and terminal blocks
14	Outdoor Control Box	Outdoor PCB and terminal blocks

- For 4 Series

UN36A (5, 7, 9 kW)

(Unit : mm)

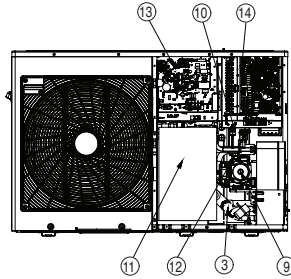
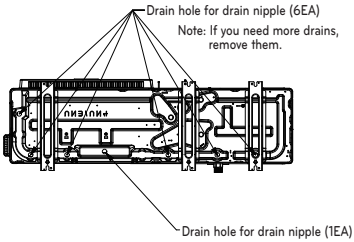
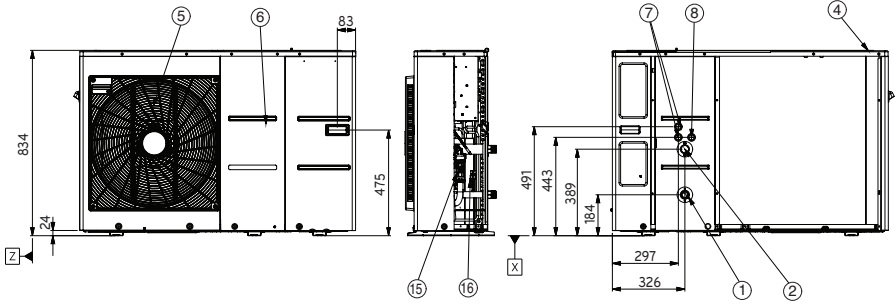
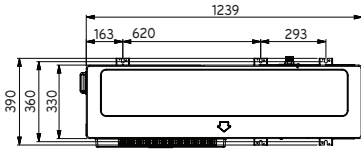

* The shape may differ depending on the model.

UN60A (12, 14, 16 kW)

(Unit : mm)

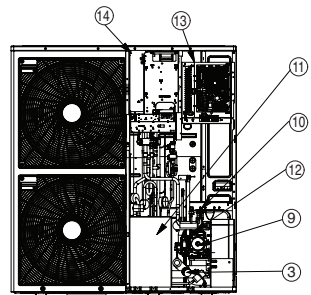
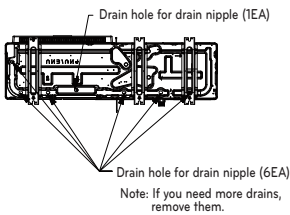
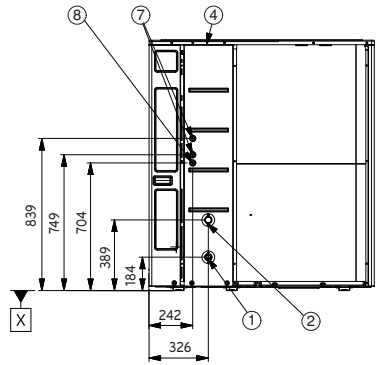
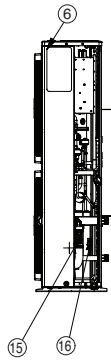
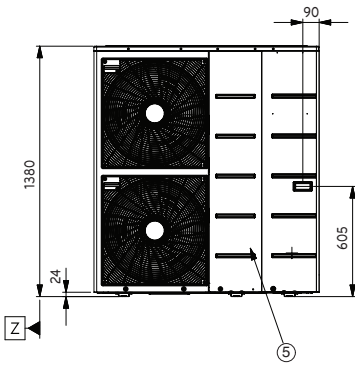
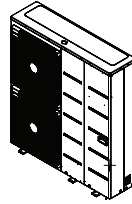
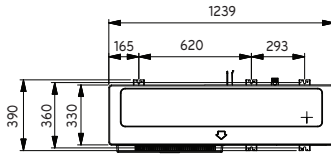

※ The shape may differ depending on the model.

Description

No	Name	Remarks
1	Entering water pipe	Male PT 1 Inch
2	Leaving water pipe	Male PT 1 Inch
3	Strainer	Filtering and stacking particles inside circulating water
4	Top cover	-
5	Front Panel	-
6	Side Panel	-
7	Low Voltage	Communication Cable Hole
8	UNIT Power	Power Cable Hole
9	Water Pump	-
10	Plate Heat Exchanger	Heat exchanger between refrigerant and water
11	Compressor shield panel	-
12	Safety Valve	Open at water pressure 3 bar
13	Indoor Control Box	PCB and terminal blocks
14	Outdoor Control Box	PCB and terminal blocks
15	Flow sensor	5-80 LPM
16	Pressure Sensor	SENSATA 2HMP3-05W 02-MPa

Control Parts

- For 3 Series

Control box before structural change (Until August, 2020)

UN36A (5, 7, 9 kW)

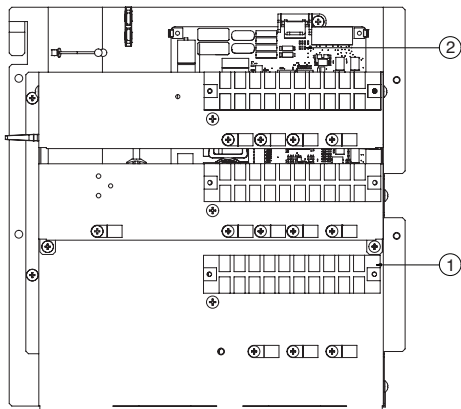

UN60A (9, 12, 14, 16 kW)

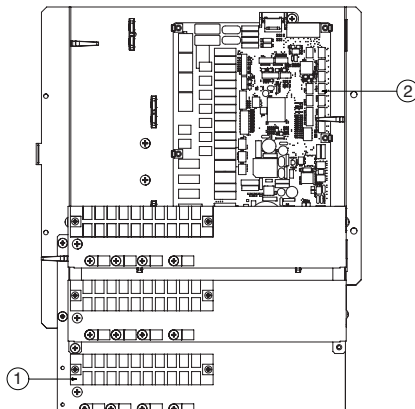

Control box after structural change (From September, 2020)

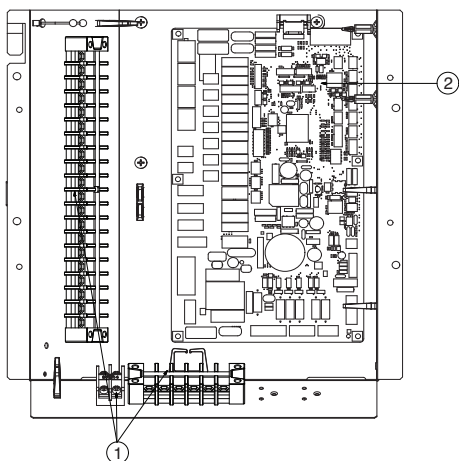

※ The shape may differ depending on the model. Refer to “Exploded View” in SVC Manual.

Description

No	Name	Remark
1	Terminal blocks	The terminal blocks allow easy connection of field wiring
2	Main PCB	The main PCB(Printed Circuit Board) controls the functioning of the unit

- For 4 Series

Control box

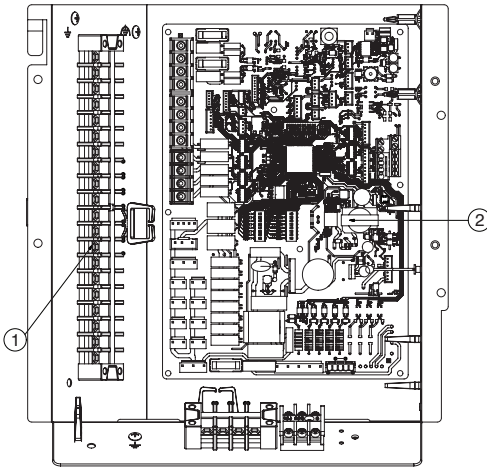

※ The shape may differ depending on the model. Refer to “Exploded View” in SVC Manual.

Description

No	Name	Remark
1	Terminal blocks	The terminal blocks allow easy connection of field wiring
2	Main PCB	The main PCB(Printed Circuit Board) controls the functioning of the unit

Remote Controller

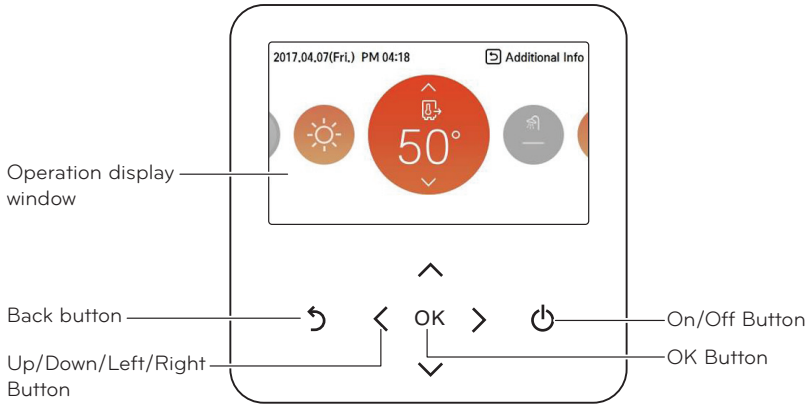

Operation display window	Operation and Settings status display
Back button	When you move to the previous stage from the menu's setting stage
Up/down/left/right button	When you change the menu's setting value
OK button	When you save the menu's setting value
On/Off button	When you turn ON/OFF the Unit

Typical Installation Example

⚠ CAUTION

If **THERMAV** is installed with pre-existing boiler, the boiler and **THERMAV** should not be operated together. If entering water temperature of **THERMAV** is above 55 °C, the system will stop operation to prevent mechanical damage of the product. For detailed electric wiring and water piping, please contact authorized installer.

Some installation scenes are presented for example. As these scenes are conceptual figures, installer should optimize the installation scene according to the installation conditions. Note that buffer tank should be installed.

CASE 1: Connecting Heat Emitters for Heating and Cooling

(Under floor loop, Fan Coil Unit, and Radiator)

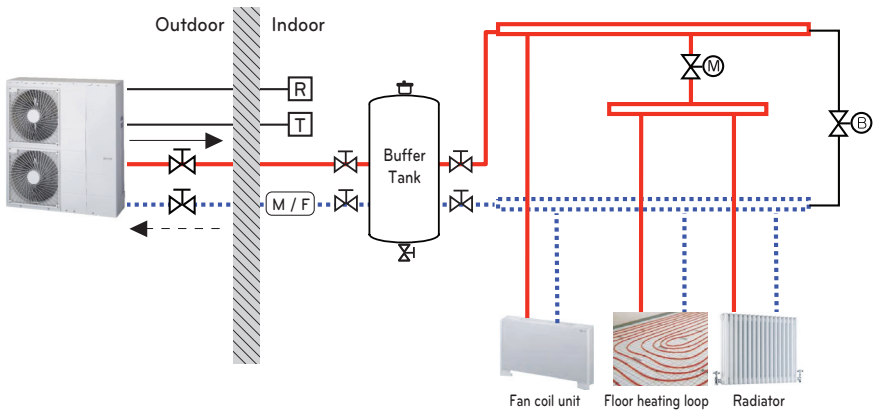

NOTE

- Room thermostat
 - Type of thermostat and specification should be complied with **THERMAV** installation manual.
- 2way valve
 - It is important to install 2way valve to prevent dew condensation on the floor and radiator while cooling mode.
 - Type of 2way control valve and specification should be complied with **THERMAV** installation manual.
 - 2way valve should be installed at the supply side of the collector.
- By-pass valve
 - To secure enough water flow rate, by-pass valve should be installed at the collector.
 - By-pass valve should guarantee minimum water flow rate in any case. Minimum water flow rate is described in water pump characteristics curve.

High Temperature	2way valve (Field supply)	Shut-off valve
Low Temperature	By-pass valve (Field supply)	Room Thermostat (Field supply)
Magnetic Filter (Mandatory)	Remote controller	

CASE 2: Connecting DHW Tank

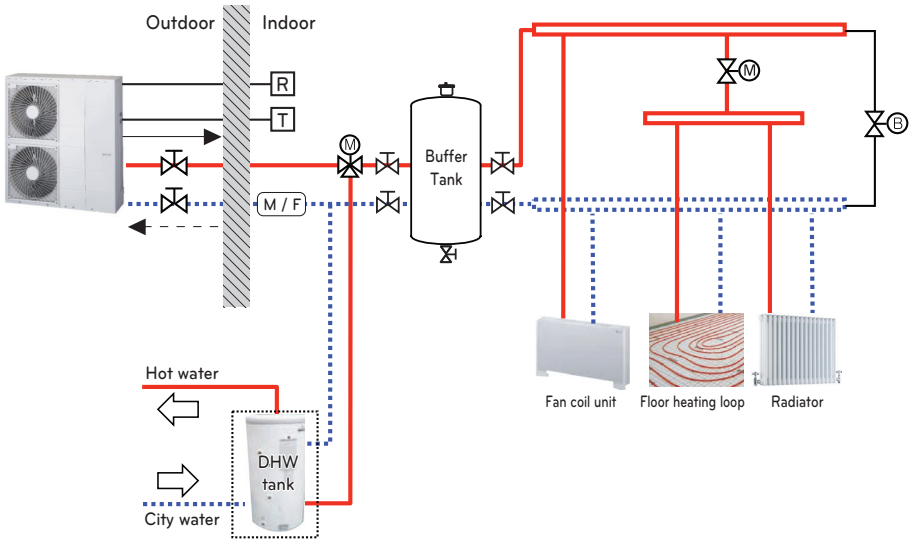

NOTE

- DHW tank
 - It should be equipped with internal electric heater to generate sufficient heat energy in very cold season.
 - DHW : Domestic Hot Water
- 3way valve
 - Type of 3way valve and specification should be complied with **THERMAV** installation manual.

High Temperature	2way valve (Field supply)	Shut-off valve
Low Temperature	3way valve (Field supply)	Room Thermostat (Field supply)
Magnetic Filter (Mandatory)	By-pass valve (Field supply)	Remote controller

CASE 3: Connecting Solar thermal system

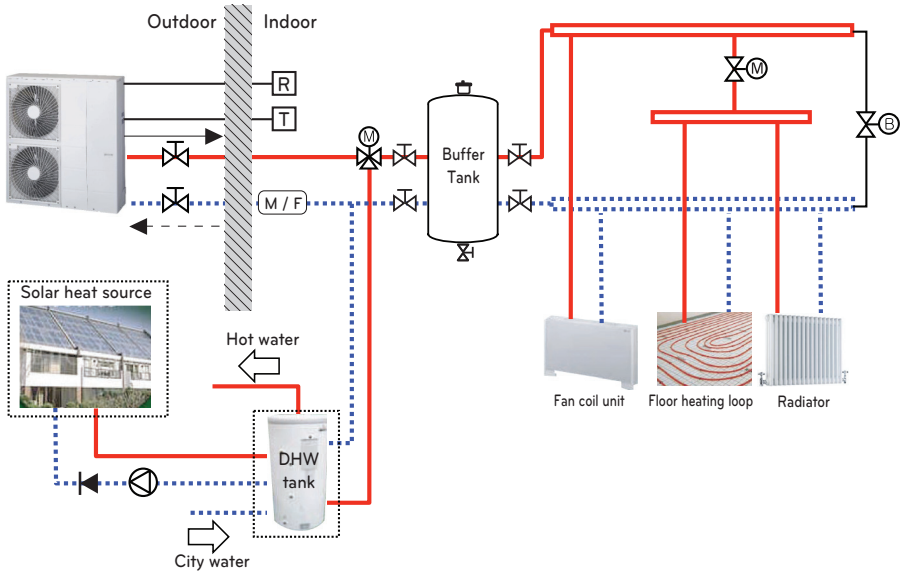

NOTE

- DHW tank
 - It should be equipped with internal electric heater to generate sufficient heat energy in very cold season.
 - DHW : Domestic Hot Water
- Pump
 - Maximum power consumption of pump should be less than 0.25 kW.

High Temperature	2way valve (Field supply)	Room Thermostat (Field supply)
Low Temperature	3way valve (Field supply)	Remote controller
Magnetic Filter (Mandatory)	By-pass valve (Field supply)	Check Valve (Backflow Preventor, Field supply)
Shut-off valve	Pump (Field supply)	

CASE 4-1: Connecting 2nd Circuit (For 3 Series)

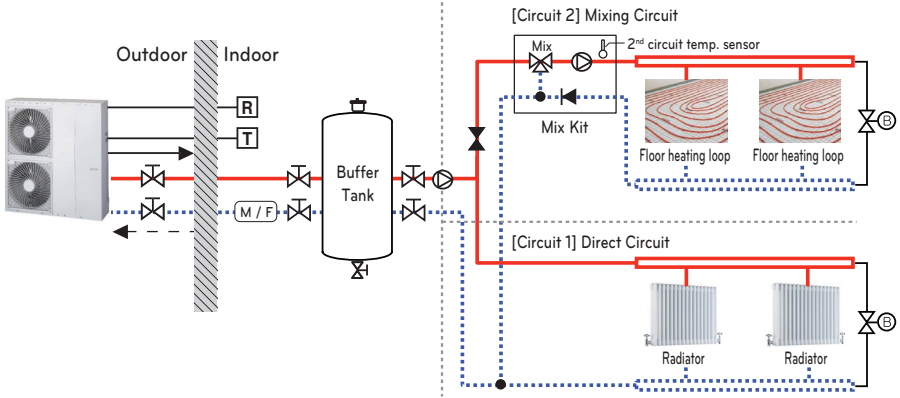

CASE 4-2: Connecting 2nd Circuit (For 4 Series)

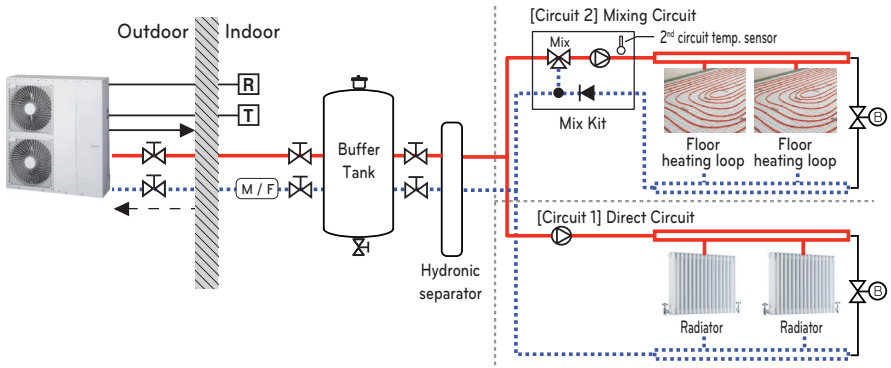

NOTE

- Mix Kit
 - You can install it when you want to set the temperature of two rooms individually
 - When heating, Circuit 2 can not be higher than Circuit 1.
 - When cooling, Circuit 2 can not be lower than Circuit 1.
 - The types and specifications of the Mix Kit are to comply with **THERMAV** Installation Manual.

High Temperature	2way valve (Field supply)	Room Thermostat (Field supply)
Low Temperature	3way valve (Field supply)	Air vent (Field supply)
Magnetic Filter (Mandatory)	By-pass valve (Field supply)	Pressure Regulation valve (Field supply)
Shut-off valve	Pump (Field supply)	Mix Kit (Field supply)

CASE 5: Connecting 3rd Party

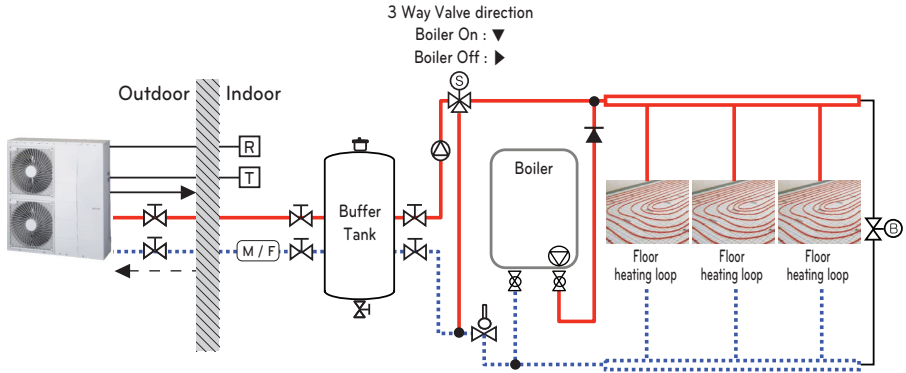

NOTE

- DHW tank
 - 3rd Party Boiler
 - You can control the boiler automatically and manually by comparing the outside temperature and the set temperature.
- 3way valve
 - It is a valve for DHW use.
 - Not installed when installing Buffer Tank
 - Type of 3way valve and specification should be complied with **THERMAV** installation manual.

High Temperature	2way valve (Field supply)	Room Thermostat (Field supply)
Low Temperature	3way valve (Field supply)	Air vent (Field supply)
Magnetic Filter (Mandatory)	By-pass valve (Field supply)	AquaStat Valve
Shut-off valve	Pump (Field supply)	Check Valve

CASE 6 : Connecting backup heater

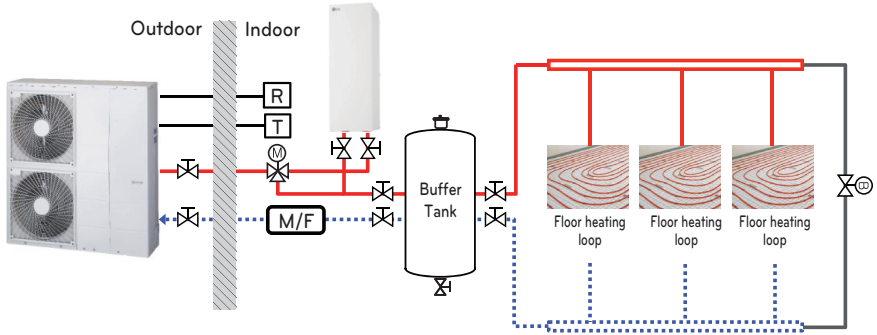

NOTE

- Backup heater(Accessory)
 - You can retain sufficient capacity even though ambient temperature will be decreased in winter.
 - During cooling operation, connect the 3-Way Valve with automatic reset function using the 2-Way Valve connection terminal to prevent water from going to the Backup Heater.

High Temperature	3way valve (Field supply)	Shut-off valve
Low Temperature	By-pass valve (Field supply)	Room Thermostat (Field supply)
Magnetic Filter (Mandatory)	Remote controller	

Cycle Diagram

- For 3 Series

UN60A (12, 14, 16 kW)

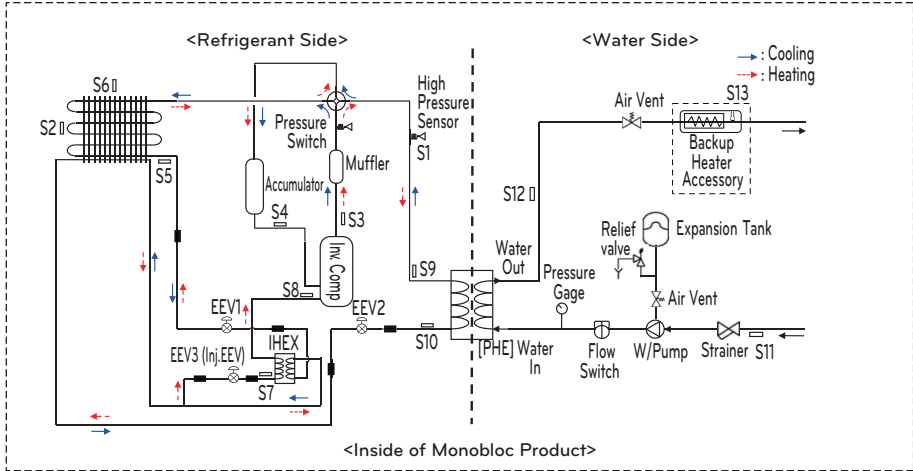

UN36A (5, 7, 9 kW)

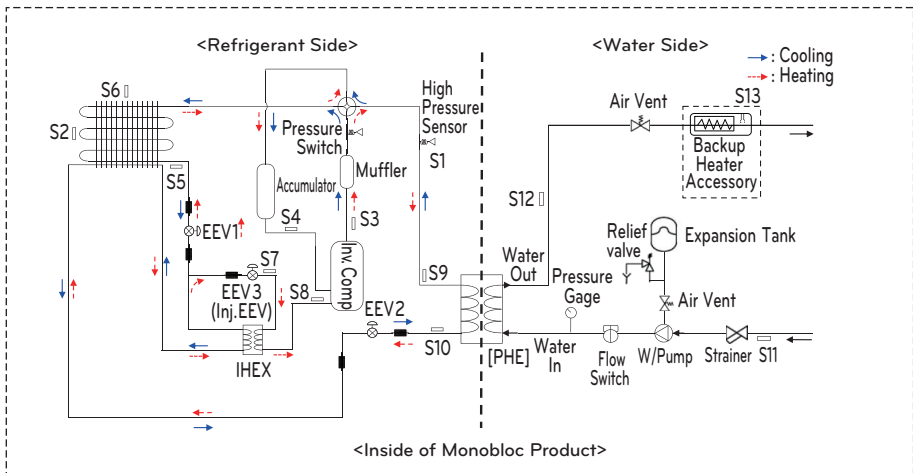

UN60A (1Ø : 9 kW)

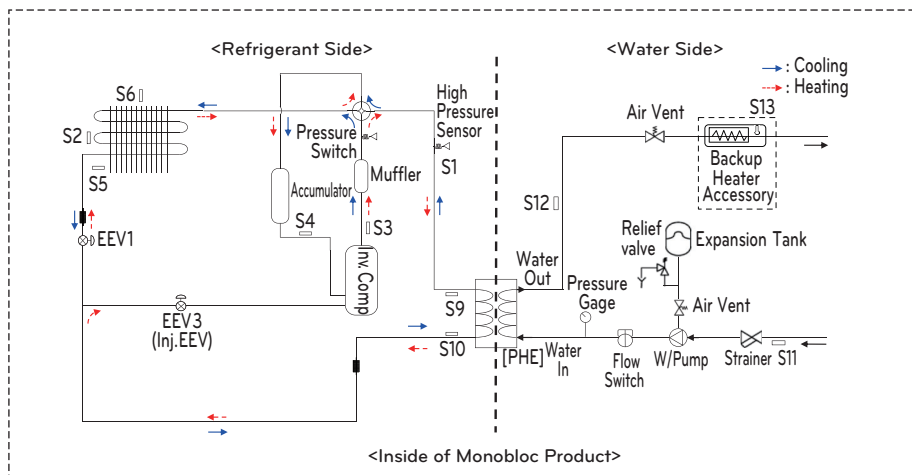

Description

Category	Symbol	Meaning	PCB Connector
Indoor Unit	S1	High pressure sensor	CN_H_PRESS
	S2	Condenser middle temperature sensor	CN_MID
	S3	Compressor-discharge pipe temperature sensor	CN_DISCHA
	S4	Compressor-suction pipe temperature sensor	CN_SUCTION
	S5	Condenser temperature sensor	CN_C_PIPE
	S6	Outdoor air temperature sensor	CN_AIR
	S7	Inlet IHX temperature sensor	CN_VI_IN
	S8	Outlet IHX temperature sensor	CN_VI_OUT
	S9	PHEX gas temp. sensor	CN_PIPE_OUT
	S10	PHEX liquid temp. sensor	CN_PIPE_IN
Water Side	S11	Entering water temperature sensor	CN_TH3
	S12	Leaving water temperature sensor	
	S13	Electric backup heater outlet (Accessory kit)	

-S9, S10, S5 : Description is expressed based on Cooling mode.

- For 4 Series

UN36A (5, 7, 9 kW)

UN60A (12, 14, 16 kW)

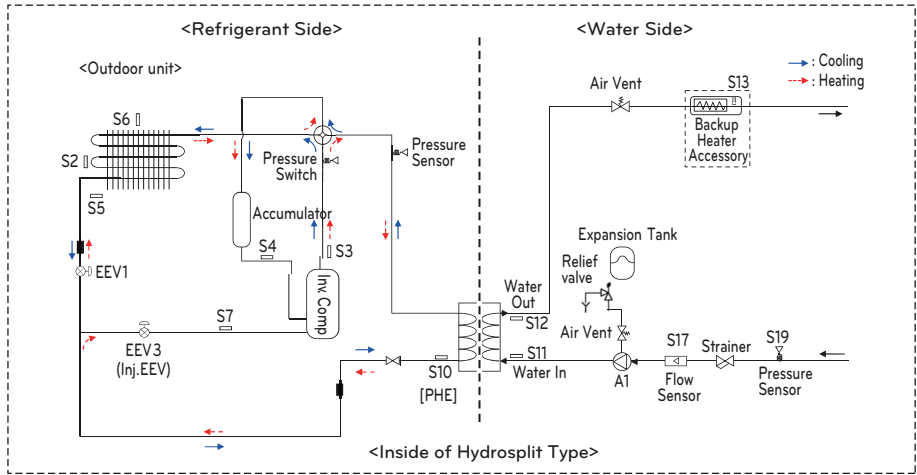

Description

Category	Symbol	Meaning	PCB Connector
Refrigerant side	S1	PHEX liquid temperature sensor	CN_PIPE_IN
	S2	Outdoor-HEX middle temperature sensor	CN_MID
	S3	Compressor-discharge pipe temperature sensor	CN_DISCHARGE
	S4	Compressor-suction pipe temperature sensor	CN_SUCTION
	S5	Outdoor-HEX temperature sensor	CN_C_PIPE
	S6	Outdoor air temperature sensor	CN_AIR
	S7	Compressor-injection pipe temperature sensor	CN_VI_IN
	EEV1	Electronic Expansion Valve (Heating/Cooling)	CN_EEV1
Water Side	S12	Outlet water temperature sensor	CN_WATER_OUT
	S11	Inlet water temperature sensor	CN_WATER_IN
	S13	Backup heater outlet sensor	CN_TH3
	S17	Flow sensor	CN_F_SENSOR
	S19	Water pressure sensor	CN_H2O_PRESS
	A1	Main Water Pump	CN_PUMP_A1 CN_MOTOR1
	A8	Electric backup heater(1Ø, Optional accessory)	CN_HEATER_PCB
A9	Electric backup heater(3Ø, Optional accessory)	HEATER1	

Water cycle

- For 3 Series

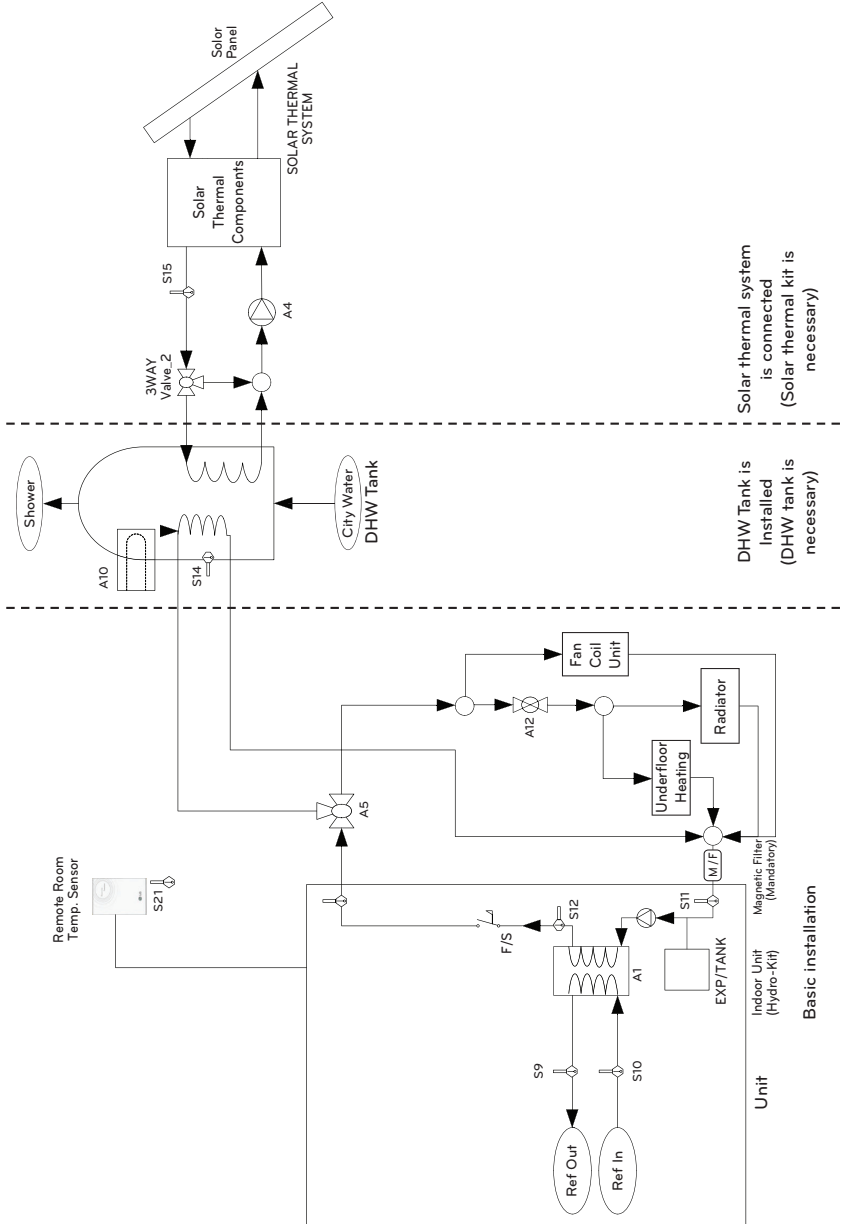

Solar thermal system is connected (Solar thermal kit is necessary)

DHW Tank is installed (DHW tank is necessary)

Basic installation

- For 4 Series

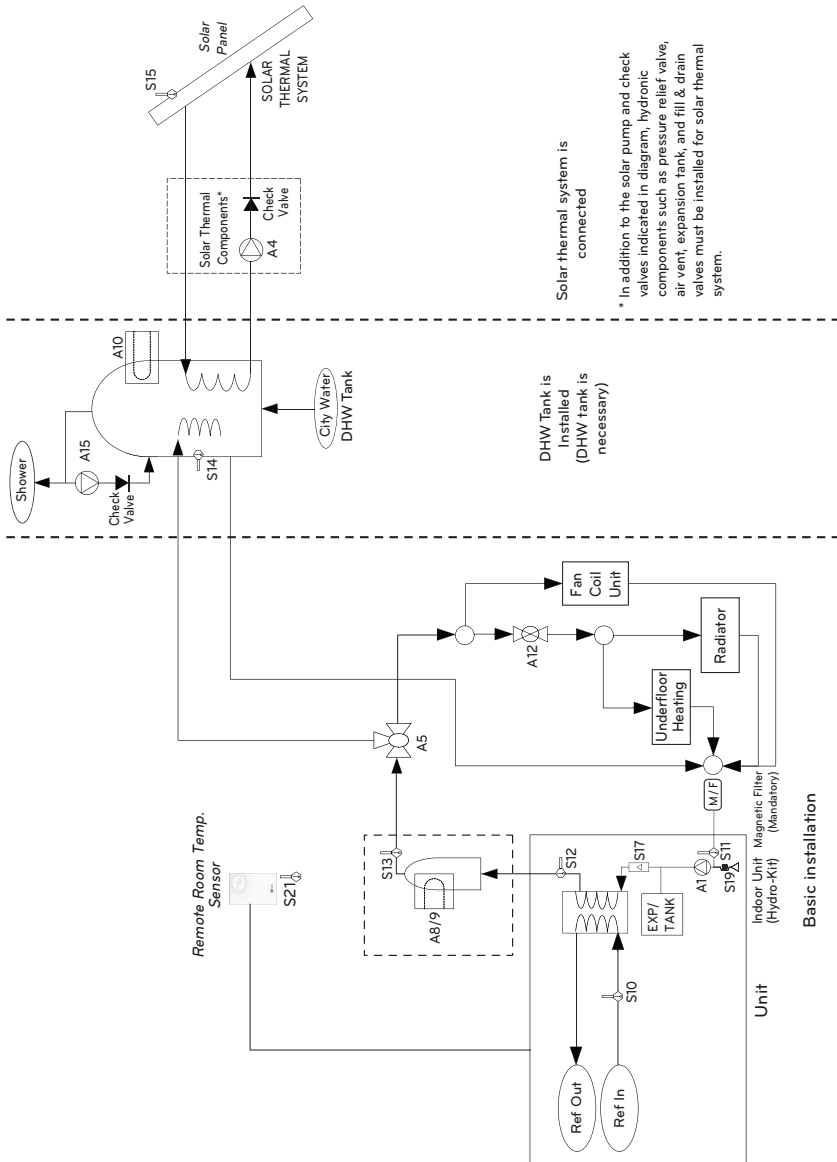

Description

Category	Symbol	Meaning	PCB Connector	Remarks
Unit	S9	Refrigerant temperature sensor (Gas side)	CN_PIPE_OUT	- Meaning is expressed based on Cooling mode.
	S10	Refrigerant temperature sensor (Liquid side)	CN_PIPE_IN	
	S11	Water temperature sensor (Water In)	Water_IN	
	S12	Water temperature sensor (Water Out)	Water_OUT	
	F/S	Flow Switch	CN_FLOW1	
	A1	Internal water pump	CN_PUMP_A1 CN_MOTOR1	- Power is supplied via CN_PUMP_A1 - PWM signal is supplied via CN_MOTOR1
	S17	Flow Sensor	CN_F_SENSOR	- To monitor water flow rate
	EXP/TANK	Expansion Tank	(no connector)	- Absorb volume change of heated water,
	S21	Remote Air temperature sensor	CN_ROOM	- Optional accessory (sold separately) - Model : PQRSTA0
	CTR/PNL	Remote Controller	CN_REMO	
	A12	To control water flow for Fan Coil Unit	CN_2WAY(A)	- 3 rd party accessory and Field installation (sold separately) - 2 wire NO or NC type 2way valve is supported.
	M / F	Magnetic Filter	(No connector)	- 3 rd party accessory and Field installation (sold separately) - It is Mandatory to install an additional filter on the heating water circuit.
Electric Heater	A8 / A9	Electric Backup Heater	For 3 series : CN_E/HEAT(A), CN_E/HEAT(B) For 4 series : TB_HEAT_CONTACT	- Optional accessory (sold separately) - Model : HA***M E* - Heating capacity is divided into two level : partial capacity by E/HEAT(A) and full capacity by E/HEAT(A) + E/HEAT(B). - Operating power(220-240 V~ 50 Hz) of E/HEAT(A) and E/HEAT(B) are supplied by external power source via relay connector and ELB.
	S13	Backup heater outlet temperature sensor	CN_TH3	
Domestic hot water circuit	W/TANK	DHW Tank	(no connector)	- 3rd party accessory and Field installation (sold separately) - Generating and storing DHW by AWHP or built-in electric heater
	A10	Booster heater(in DHW tank)	For 3 series : CN_3WAY(A) For 4 series : CN_TANK_HEATER	- 3 rd party accessory and Field installation (usually built-in at W/TANK) - Supplying additional water heating capacity.
	A5	- Flow control for water which is leaving from unit. - Flow direction switching between underfloor and water tank	CN_3WAY(A)	- 3 rd party accessory and Field installation (sold separately) - SPDT type 3way valve is supported.
	A15	Recirculation pump	CN_PUMP A15	
	CITY WATER	Water to be heated by Indoor unit and B/HT of W/TANK	(no connector)	- Field installation
	SHOWER	Water supplied to end-user	(no connector)	- Field installation
	S14	W/TANK water temperature sensor		
Solar thermal circuit	S15 (For 3 series)	Solar-heated water temperature sensor	CN_TH4	- S15 and S16 are connected at 4 pin type connector CN_TH4. - S15 is a part of DHW tank kit.(Model : PHLTB) - S16 is a part of solar thermal kit (Model:PHLLA)
	S15 (For 4 series)	Solar collector sensor	TB_SENSOR (SOLAR)	- 3rd party accessory and Field installation (sold separately) - PT1000
	3WAY Valve_2	- Flow control for water which is heated and circulated by SOLAR THERMAL SYSTEM. - Flow direction switching between SOLAR THERMAL SYSTEM and W/TANK	CN_3WAY(B)	- 3 rd party accessory and Field installation (sold separately) - SPDT type 3way valve is supported.
	A4	External Water Pump	CN_W/PUMP(B)	- 3 rd party accessory and Field installation (sold separately) - If water pump of SOLAR THERMAL SYSTEM is incapable of circulation,external water pump can be used.
	SOLAR THERMAL SYSTEM	Solar thermal equipment such as collector, solar pump, sensor, solar heat-exchanger	(no connector)	- 3 rd party accessory and Field installation (sold separately)

INSTALLATION

Transporting the Unit

- When carrying the suspended unit, pass the ropes between legs of base panel under the unit.
- Always lift the unit with ropes attached at four points so that impact is not applied to the unit.
- Attach the ropes to the unit at an angle (A) of 40° or less.
- Use only accessories and parts which are of the designated specification when installing.
- Forklift trucks are not available without a palette.
- Be careful not to damage the product when moving the forklift.

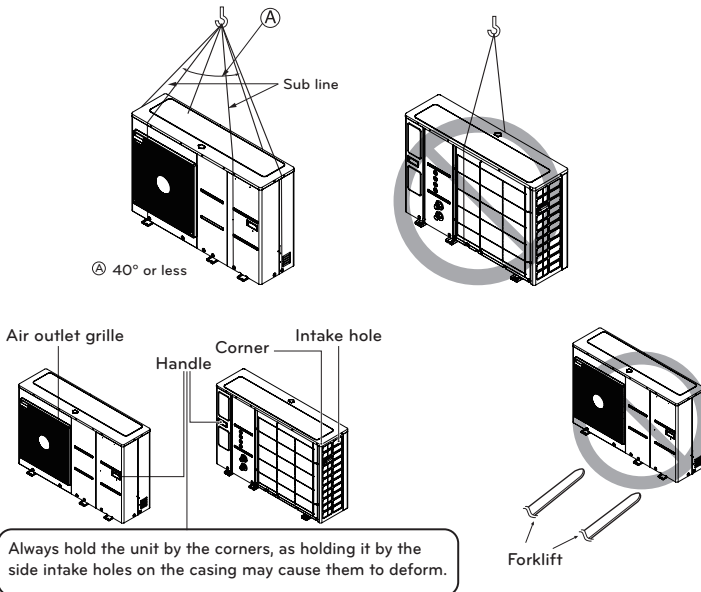

⚠ CAUTION

Be very careful while carrying the product.

- Do not have only one person carry product if it is more than 20 kg.
- PP bands are used to pack some products. Do not use them as a mean for transportation because they are dangerous.
- Do not touch heat exchanger fins with your bare hands. Otherwise you may get a cut in your hands.
- Tear plastic packaging bag and scrap it so that children cannot play with it. Otherwise plastic packaging bag may suffocate children to death.
- When carrying in Unit, be sure to support it at four points. Carrying in and lifting with 3-point support may make Outdoor Unit unstable, resulting in a fall.
- Use 2 belts of at least 8 m long.
- Place extra cloth or boards in the locations where the casing comes in contact with the sling to prevent damage.
- Hoist the unit making sure it is being lifted at its center of gravity.

Installation places

- If an awning is built over the unit to prevent direct sunlight or rain exposure, make sure that heat radiation from the condenser is not restricted.
- Ensure that the spaces indicated by arrows around front, back and side of the unit.
- Do not place animals and plants in the path of the warm air.
- Take the Unit weight into account and select a place where noise and vibration are minimum.
- Select a place so that the warm air and noise from the air conditioner do not disturb neighbors.
- Place that can sufficiently endure the weight and vibration of the outdoor unit and where even installation is possible
- Place that has no direct influence of snow or rain
- Place with no danger of snowfall or icicle drop
- Place without weak floor or base such as decrepit part of the building or with a lot of snow accumulation
- In places where there is a lot of snow, place the unit higher than the snow can be accumulated.

Seasonal Wind and Cautions in Winter

In areas with low ambient temperature, high humidity, or heavy snowfall, particular measures are required to ensure that the unit operates properly.

- Install the unit so that it does not come into direct contact with snow. If snow accumulates and freezes in the air inlet, the system may malfunction. When installing in an area with heavy snowfall, attach the hood to the system.
- Install the suction and discharge ducts to prevent the entry of snowfall or rainfall.
- When installing in an area with heavy snowfall, install it on an installation console which is 500mm higher than the average snowfall (annual average snowfall).
- The height of the H frame must be at least twice the amount of snowfall and its width must not exceed the width of the unit. (Snow may accumulate if the width of the frame is wider than the width of the unit.)
- If condensed water from the outdoor unit freezes around the product, the floor/ground may become slippery and cause an accident, so do not install the outdoor unit near a sidewalk. If it is unavoidable, install a water channel or drainage pipe to prevent condensed water from flowing onto the sidewalk.
- Use "Rapid Defrost Mode" in sites with snowfall or low temperatures and high humidity.
 - * The Rapid Defrost Mode is a rapid defrost mode designed to prevent accumulated icing in sites with snowfall or low temperatures and high humidity. Refer to "Dip Switch Setting".
- If more than 100mm of snow has accumulated on the top of the product, be sure to remove the snow before carrying out any work on the unit.
- Do not install the inlet or outlet of the unit so that they face seasonal winds.
- Make preparations for snow and/or seasonal winter winds in all areas in which the unit is installed.

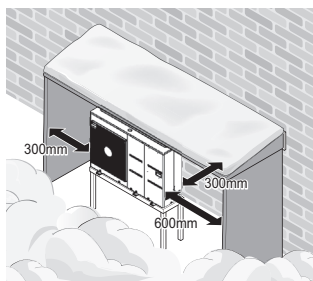
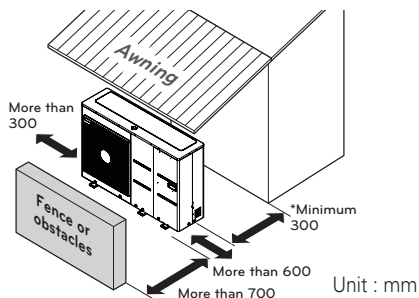

* : Please secure the space to Maintain the shut-off valve and strainer.

Multiple installation

When installing two or more units, please observe the installation space.

- If there is an obstruction in the intake

Unit : mm

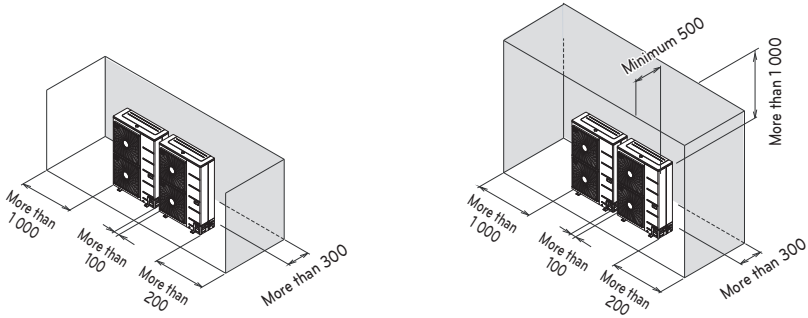

- If there is an obstruction in the discharge part

Unit : mm

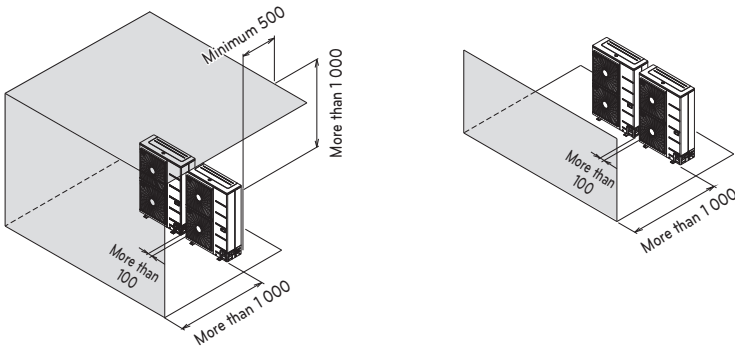

- When there is an obstacle in the suction or discharge part

Unit : mm

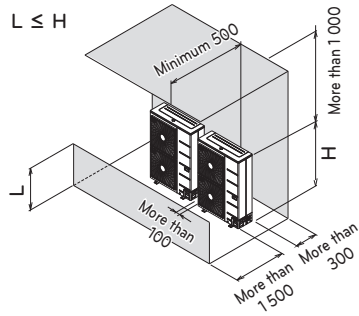
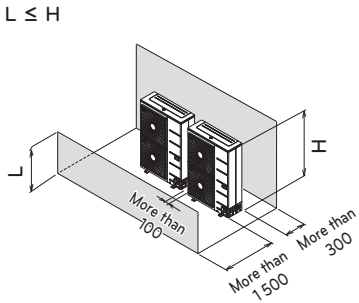
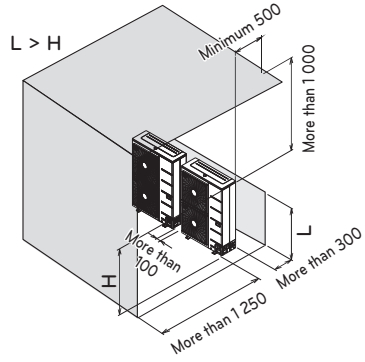
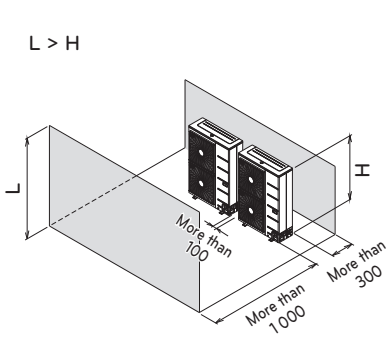

- Multiple installation on the roof

Unit : mm

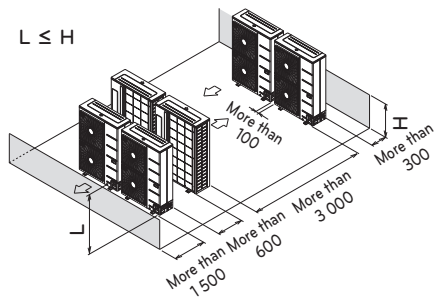
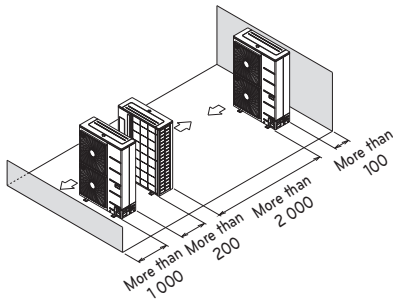

Installation at Seaside

CAUTION

- Unit should not be installed in areas where corrosive gases, such as acid or alkaline gas, are produced.
- Do not install the unit where it could be exposed to sea wind (salty wind) directly. It can result corrosion on the unit. Corrosion, particularly on the condenser and evaporator fins, could cause unit malfunction or inefficient performance.
- If unit is installed close to the seaside, it should avoid direct exposure to the sea wind. Otherwise it needs additional anticorrosion treatment on the heat exchanger.

Selecting the location

- If the unit is to be installed close to the seaside, direct exposure to the sea wind should be avoided. Install the unit on the opposite side of the sea wind direction.

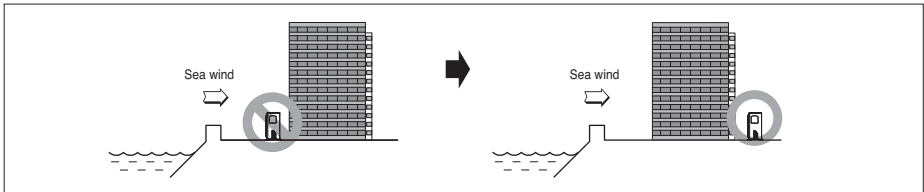

- In case, to install the unit on the seaside, set up a windbreak not to be exposed to the sea wind.

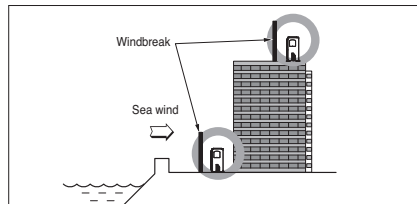

- It should be strong enough like concrete to prevent the sea wind from the sea.
 - The height and width should be more than 150 % of the unit.
 - It should be kept more than 700 mm of space between unit and the windbreak for easy air flow.
- Select a well-drained place.
 - If you can't meet above guide line in the seaside installation, please contact your supplier for the additional anticorrosion treatment.
 - Periodic (more than once/year) cleaning of the dust or salt particles stuck on the heat exchanger by using water

Foundation for Installation

- Check the strength and level of the installation ground so that the unit will not cause any operating vibration or noise after installation.
- Fix the unit securely by means of the foundation bolts. (Prepare 6sets of M12 foundation bolts, nuts and washers each which are available on the market.)
- It is best to screw in the foundation bolts until their length are 20 mm from the foundation surface.
- When installing the unit on the ground, install a separate pedestal with enough height to install the drain nipple.

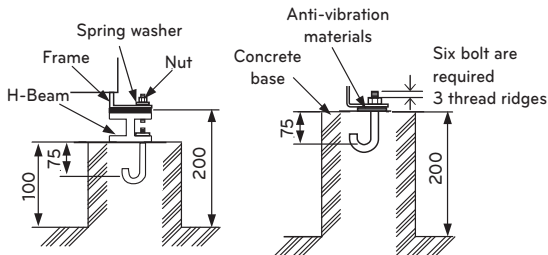
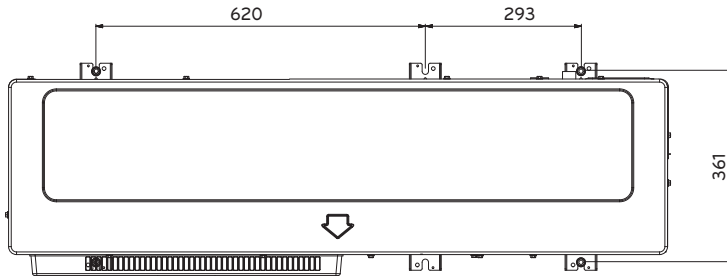

[Unit:mm]

Foundation bolt executing method

! WARNING

- Be sure to remove the Pallet(Wood Support) of the bottom side of the unit Base Pan before fixing the bolt. It may cause the unstable state of the unit settlement, and may cause freezing of the heat exchanger resulting in abnormal operations.
- Be sure to remove the Pallet(Wood Support) of the bottom side of the unit before welding. Not removing Pallet(Wood Support) causes hazard of fire during welding.

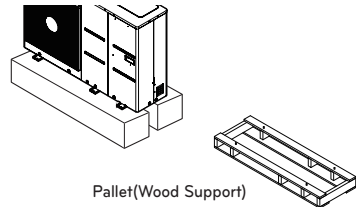

Pallet(Wood Support)
- Remove before Installation

Electrical Wiring

- Follow ordinance of your governmental organization for technical standard related to electrical equipment, wiring regulations and guidance of each electric power company.

WARNING

- Be sure to have authorized electrical engineers do the electric work using special circuits in accordance with regulations and this installation manual. If power supply circuit has a lack of capacity or electric work deficiency, it may cause an electric shock or fire.
- Install the Unit transmission line away from the power source wiring so that it is not affected by electric noise from the power source. (Do not run it through the same conduit.)
- Be sure to provide designated grounding work to Unit.

CAUTION

- Be sure to correct the unit to earth. Do not connect earth line to any gas pipe, liquid pipe, lightning rod or telephone earth line. If earth is incomplete, it may cause an electric shock.
- Give some allowance to wiring for electrical part box of Units, because the box is sometimes removed at the time of service work.
- Never connect the main power source to terminal block of transmission line. If connected, electrical parts will be burnt out.
- Only the transmission line specified should be connected to the terminal block for Unit transmission.

CAUTION

- This product have reversed phase protection detector that only works when the power is turned on. If there exists black out or the power goes on and off which the product is operating, attach a reversed phase protection circuit locally. running the product in reversed phase may break the compressor and other parts.
- Use the 2-core shield cables for communication lines. Never use them together with power lines.
- The conductive shielding layer of cable should be grounded to the metal part of both units.
- Never use multi-core cable
- As this unit is equipped with an inverter, to install a phase leading capacitor not only will deteriorate power factor improvement effect, but also may cause capacitor abnormal heating. Therefore, never install a phase leading capacitor.
- Make sure that the power unbalance ratio is not greater than 2 %. If it is greater, the unit's lifespan will be reduced.
- Introducing with a missing N-phase or with a mistaken N-phase will break the equipment

! CAUTION

The power cable connected to the unit should be complied with IEC 60245 or HD 22.4 S4 (This equipment shall be provided with a cable set complying with the national regulation. Pipes and wires should be purchased separately for installation of the product.)

Select a circuit breaker and power cable suitable for the current specification.

Factory Model Name	Buyer Model Name	Phase[Ø]	Capacity [kW]	ELCB
ZHBW056A0	HM051M U43	1	5	16 A
ZHBW076A0	HM071M U43		7	20 A
ZHBW096A0	HM091M U43		9	25 A
ZHBW096S0	HM091MRS U33	1	9	16 A
ZHBW126A0	HM121M U33		12	40 A
ZHBW146A0	HM141M U33		14	40 A
ZHBW166A0	HM161M U33		16	40 A
ZHBW128A0	HM123M U33	3	12	16 A
ZHBW148A0	HM143M U33		14	16 A
ZHBW168A0	HM163M U33		16	16 A
ZHBW056A1	HM051MR U44	1	5	16 A
ZHBW076A1	HM071MR U44		7	20 A
ZHBW096A1	HM091MR U44		9	25 A
ZHBW098A1	HM093MR U44	3	9	16 A
ZHBW126A1	HM121MR U34	1	12	40 A
ZHBW146A1	HM141MR U34		14	40 A
ZHBW166A1	HM161MR U34		16	40 A
ZHBW128A1	HM123MR U34	3	12	16 A
ZHBW148A1	HM143MR U34		14	16 A
ZHBW168A1	HM163MR U34		16	16 A

Power cable (Type : H07RNF)	
Current [A]	Area [mm ²]
[A] ≤ 0.2	Tinsel cord ^a
0.2 < [A] ≤ 3	0.5 ^a
3 < [A] ≤ 6	0.75
6 < [A] ≤ 10	1.0 (0.75) ^b
10 < [A] ≤ 16	1.5 (1.0) ^b
16 < [A] ≤ 25	2.5
25 < [A] ≤ 32	4
32 < [A] ≤ 40	6
40 < [A] ≤ 63	10

a These cords may only be used if their length does not exceed 2 m between the point where the cord or cord guard enters the appliance and the entry to the plug.

b Cords having the cross-sectional areas indicated in the parentheses may be used for portable appliances if their length does not exceed 2 m.

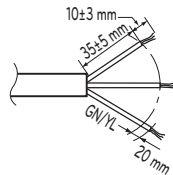

For the 1-Phase

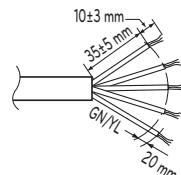

For the 3-Phase

Precautions when laying power wiring

Use round pressure terminals for connections to the power terminal block.

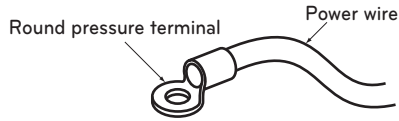

When none are available, follow the instructions below.

- Do not connect wiring of different thicknesses to the power terminal block. (Slack in the power wiring may cause abnormal heat.)
- When connecting wiring which is the same thickness, do as shown in the figure below.

Connect same thickness wiring to both sides.

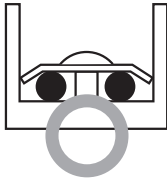

It is forbidden to connect two to one side.

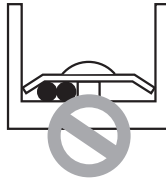

It is forbidden to connect wiring of different thicknesses.



- For wiring, use the designated power wire and connect firmly, then secure to prevent outside pressure being exerted on the terminal block.
- Use an appropriate manual screwdriver instead of electric screwdriver for tightening the terminal screws. A screwdriver with a small head will strip the head and make proper tightening impossible.
- Over-tightening the terminal screws may break them.

! WARNING

- Make sure that the screws of the terminal are free from looseness.

**Point for attention regarding quality of the public electric power supply
(For 3 Series)**

- European/International Technical Standard setting the limits for voltage changes, voltage fluctuations and flicker in public low-voltage supply systems for equipment with rated current ≤ 75 A.
- European/International Technical Standard setting the limits for harmonic currents produced by equipment connected to public low-voltage systems with input current ≤ 16 A or > 75 A per phase.

For 1 Phase (12, 14, 16 kW)

- This equipment complies with IEC (EN) 61000-3-12 in harmonic currents emission limits corresponding $R_{sce} = 33$.
- This equipment complies with reference impedance for IEC (EN) 61000-3-3.

For 3 Phase (12, 14, 16 kW)

- This equipment complies with IEC (EN) 61000-3-12 provided that the short-circuit power S_{sc} is greater than or equal to 2067 kVA at the interface point between the user's supply and the public system. It is the responsibility of the installer or user of the equipment to ensure, by consultation with the distribution network operator if necessary, that the equipment is connected only to a supply with a short-circuit power S_{sc} greater than or equal to 2067 kVA.
- This equipment complies with IEC (EN) 61000-3-3.

For 1 Phase (5, 7, 9 kW)

- This equipment complies with IEC (EN) 61000-3-12 in harmonic currents emission limits corresponding $R_{sce} = 33$.
- This equipment complies with IEC (EN) 61000-3-3.

Point for attention regarding quality of the public electric power supply (For 4 Series)

- European/International Technical Standard setting the limits for voltage changes, voltage fluctuations and flicker in public low-voltage supply systems for equipment with rated current ≤ 75 A.
 - European/International Technical Standard setting the limits for harmonic currents produced by equipment connected to public low-voltage systems with input current ≤ 16 A or > 75 A per phase.
-

For 1 Phase (12, 14, 16 kW)

- This equipment complies with IEC (EN) 61000-3-12 in harmonic currents emission limits corresponding $R_{sce} = 33$.
 - This equipment complies with reference impedance for IEC (EN) 61000-3-11.
-

For 3 Phase (12, 14, 16 kW)

- This equipment complies with IEC (EN) 61000-3-12 provided that the short-circuit power S_{sc} is greater than or equal to 2672 kVA at the interface point between the user's supply and the public system. It is the responsibility of the installer or user of the equipment to ensure, by consultation with the distribution network operator if necessary, that the equipment is connected only to a supply with a short-circuit power S_{sc} greater than or equal to 2672 kVA.
 - This equipment complies with IEC (EN) 61000-3-3.
-

For 1 Phase (5, 7 kW)

- This equipment complies with IEC (EN) 61000-3-2.
- This equipment complies with IEC (EN) 61000-3-3.

For 1 Phase (9 kW)

- This equipment complies with IEC (EN) 61000-3-12 in harmonic currents emission limits corresponding $R_{sce} = 33$.
 - This equipment complies with IEC (EN) 61000-3-3.
-

For 3 Phase (9 kW)

- This equipment complies with IEC (EN) 61000-3-12 provided that the short-circuit power S_{sc} is greater than or equal to 2394 kVA at the interface point between the user's supply and the public system. It is the responsibility of the installer or user of the equipment to ensure, by consultation with the distribution network operator if necessary, that the equipment is connected only to a supply with a short-circuit power S_{sc} greater than or equal to 2394 kVA.
- This equipment complies with IEC (EN) 61000-3-3.

Circuit Breaker Specification

Perform the electrical wiring work according to the electrical wiring connection.

- All wiring must comply with local requirements.
- Select a power source that is capable of supplying the current required by the appliance.
- Use a recognized ELCB(Electric Leakage Circuit Breaker) between the power source and the unit. A disconnection device to adequately disconnect all supply lines must be fitted.
- Model of circuit breaker recommended by authorized personnel Only.
- Select a circuit breaker suitable for the current specification.

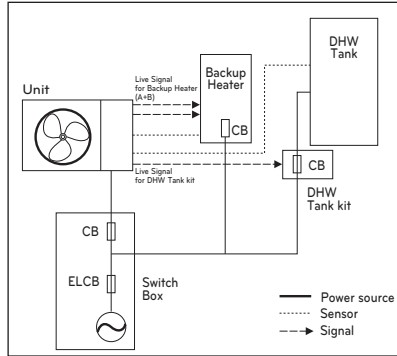

*CB : Circuit Breaker

*ELCB : Electric Leakage Circuit Breaker

Wiring procedure for power cable

This cable is generally connected between external power source (such as main electric power distribution panel of user's house) and the unit. Before starting wiring, check if wire specification is suitable and read following directions and cautions VERY carefully.

⚠ CAUTION

After checking and confirming following conditions, start wiring work.

- Secure dedicated power source for the Air-to-Water heat pump. The wiring diagram (attached inside the control box of the unit) is presenting related information.
- Provide a circuit breaker switch between power source and the outdoor unit.
- Although it is very rare case, sometimes the screws used to fasten internal wires can be loosen due to the vibration while product transportation. Check these screws and make it sure if they are all fastened tightly. If not tightened, burn-out of the wire can be occurred.
- Check the specification of power source such as phase, voltage, frequency, etc.
- Confirm that electrical capacity is sufficient.
- Be sure that the starting voltage is maintained at more than 90 percent of the rated voltage marked on the name plate.
- Confirm that the cable thickness is as specified in the power sources specification. (Particularly note the relation between cable length and thickness.)
- Provide an ELB(electric leakage breaker) when the installation place is wet or moist.
- The following troubles would be caused by abnormal voltage supply such as sudden voltage increasing or voltage drop-down.
 - Chattering of a magnetic switch (frequent on and off operation)
 - Physical damage of parts where magnetic switch is contacted
 - Break of fuse
 - Malfunction of overload protection parts or related control algorithms.
 - Failure of compressor start up
 - Ground wire to ground outdoor unit to prevent electrical shock.

Step 1. Disassemble side panel and front panel from the unit by loosening screws.

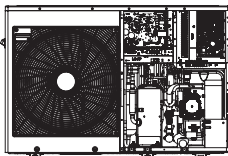

UN36A

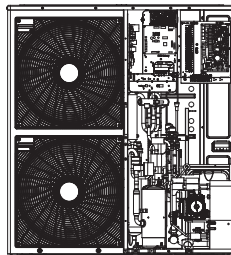

UN60A

* The feature may be vary according to the type of model.

Step 2. Connect power cable to main power terminal block.

See below figure for detailed information. When connecting power cable, the diameter of cable should refer to the electrical wiring.

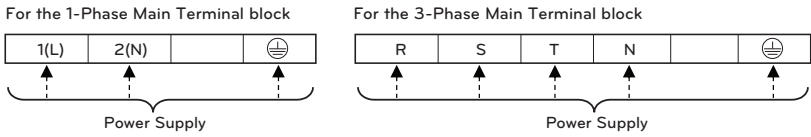
**Step 3.** Use cable clamps (or cord clamps) to prevent unintended move of power cable.**Step 4.** Reassemble the side panel to the unit by fastening screws.

(3 series)
UN36A

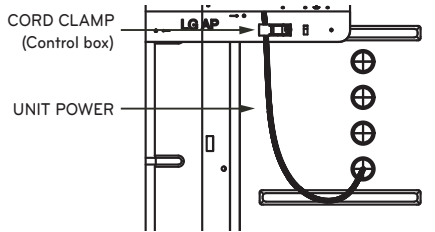

(4 series)
UN36A

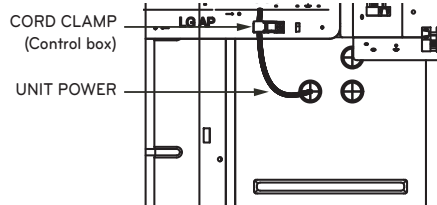

UN60A

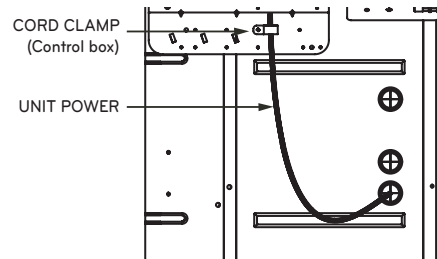

* The feature may be vary according to the type of model.

Failure to do these instruction can result in fire, electric shock or death.

- Make sure the power cable do not touch to copper tube.
- Make sure to fix [cord clamp] firmly to sustain the connection of terminal.
- Make sure to connect unit power & heater power separately.

Terminal Block Information

- For 3 Series

Symbols used below pictures are as follows :

- L, L1, L2 : Live (220-240 V~)
- N : Neutral (220-240 V~)
- BR : Brown, WH : White, BL : Blue, BK : Black

Case 1 (From September, 2020)

Terminal Block 1

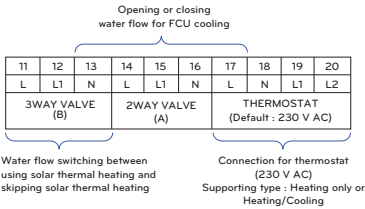
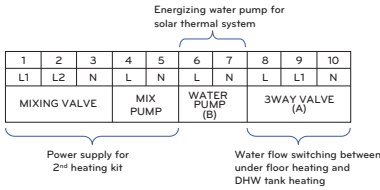

Case 2 (Until August, 2020)

Terminal Block 1

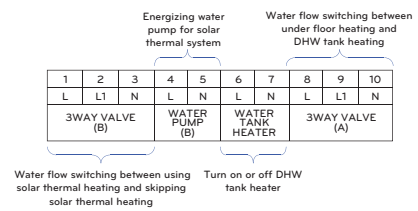

Terminal Block 2

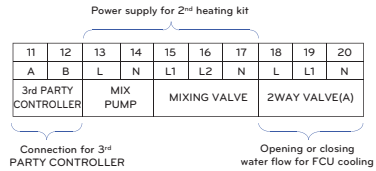

Terminal Block 2



Terminal Block 3

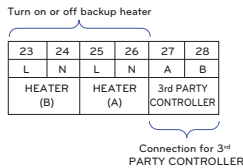

Terminal Block 3

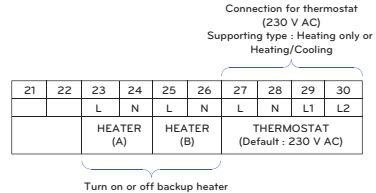

Terminal Block 4

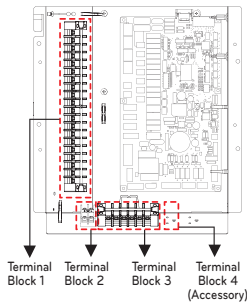
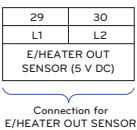

Terminal Block 4

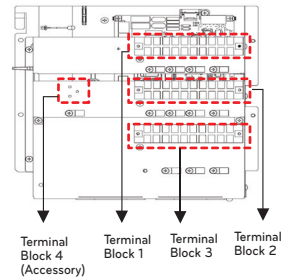
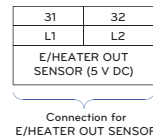

* Refer to Terminal Block Information according to the C/Box shape.

- For 4 Series

Symbols used below pictures are as follows :

- L, L1, L2 : Live (220-240 V~)
- N : Neutral (220-240 V~)
- BR : Brown, WH : White, BL : Blue, BK : Black

Terminal Block 1

1	2	3	4	5	6	7	8	9
L	L1	N	L	L1	N	L	L1	N
MIXING VALVE			2WAY VALVE (A)			3WAY VALVE (A)		

Power supply for 2nd heating kit

Water flow switching between under floor heating and DHW tank heating

Energizing water pump for solar thermal system

10	11	12	13	14	15	16	17	18	19	20
L	L1	N	L	N	L	N	L	N	L	N
3WAY VALVE (B)			WATER TANK HEATER		WATER PUMP(B)		MIX PUMP		WATER PUMP(C)	

Water flow switching between using solar thermal heating and skipping solar thermal heating

Power supply for 2nd heating kit

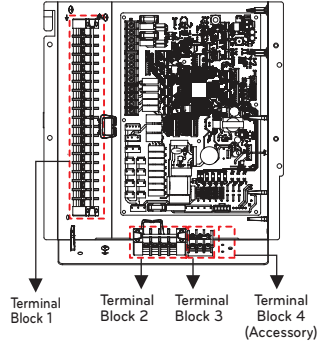

Terminal Block 2

Terminal Block 3

21	22	23	24	25	26	27
L	N	L1	L2	L3	A	B
THERMOSTAT (Default : 230 V AC)					3rd PARTY CONTROLLER (5V DC)	

Connection for thermostat (230 V AC)
Supporting type : Heating only or Heating/Cooling

Connection for 3rd PARTY CONTROLLER

Terminal Block 4

28	29
L1	L2
E/HEATER OUT SENSOR (5 V DC)	

Connection for E/HEATER OUT SENSOR

* Refer to Terminal Block Information according to the C/Box shape.

Wiring of main power supply and equipment capacity

1. Use a separate unit power and heater power.
2. Bear in mind ambient conditions (ambient temperature, direct sunlight, rain water, etc.) when proceeding with the wiring and connections.
3. The wire size is the minimum value for metal conduit wiring. The power cord size should be 1 rank thicker taking into account the line voltage drops. Make sure the power-supply voltage does not drop more than 10 %.
4. Specific wiring requirements should adhere to the wiring regulations of the region.
5. Power supply cords of parts of appliances for unit use should not be lighter than polychloroprene sheathed flexible cord.
6. Don't install an individual switch or electrical outlet to disconnect each of unit separately from the power supply.

WARNING

- Follow ordinance of your governmental organization for technical standard related to electrical equipment, wiring regulations and guidance of each electric power company.
- Make sure to use specified wires for connections so that no external force is imparted to terminal connections. If connections are not fixed firmly, it may cause heating or fire.
- Make sure to use the appropriate type of overcurrent protection switch. Note that generated overcurrent may include some amount of direct current.

CAUTION

- Some installation site may require attachment of an earth leakage breaker. If no earth leakage breaker is installed, it may cause an electric shock.
- Do not use anything other than breaker and fuse with correct capacity. Using fuse and wire or copper wire with too large capacity may cause a malfunction of unit or fire.

Water Piping and Water Circuit Connection

CAUTION

Followings are should be considered before beginning water circuit connection.

- Service space should be secured.
- Water pipes and connections should be cleaned using water.
- Space for installing external water pump should be provided if internal water pump capacity is not enough for installation field.
- Never connect electric power while proceeding water charging.

Definition of terms are as follow :

- Water piping : Installing pipes where water is flowing inside the pipe.
- Water circuit connecting : Making connection between the unit and water pipes or between pipes and pipes. Connecting valves or elbows are, for example, in this category.

Configuration of water circuit is shown in "Installation Scenes". All connections should be complied with presented diagram.

While installing water pipes, followings should be considered :

- While inserting or putting water pipes, close the end of the pipe with pipe cap to avoid dust entering.
- When cutting or welding the pipe, always be careful that inner section of the pipe should not be defective. For example, no weldments or no burrs are found inside the pipe.
- Drain piping should be provided in case of water discharge by operation of the safety valve, drain from condensate, and snow or rain.
This situation can be happened when the internal pressure is over 3.0 bar and water inside the unit will be discharged to drain hose.
- In a cold climate region, water drainage must be frost-proof.
- Pipe fittings (e.g. L-shape elbow, T-shape tee, diameter reducer, etc) should be tightened strongly to be free from water leakage.
- Connected sections should be leakage-proof treatment by applying tefron tape, rubber bushing, sealant solution, etc.
- Appropriate tools and tooling methods should be applied to prevent mechanical breakage of the connections.
- Operation time of flow valve(e.g. 3way valve or 2way valve) should be less than 90 seconds.
- While supplying water, pressure of supplying water should be 2.0 bar approximately.
- Pipe is insulated to prevent heat loss to external environment and to prevent dew generation on the surface of the pipe in cooling operation.
- Maximum allowable Torque at the water piping connection is 50 N-m

When the water pipes are connected. It must be tightened the nut with two wrench. Otherwise pipes can be deformed.

* The feature may be vary according to the type of model.

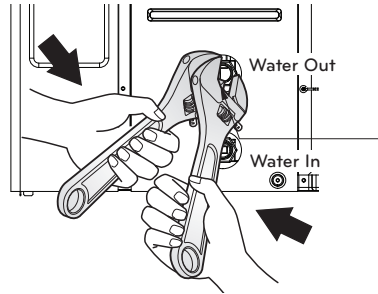

! WARNING

Installing shut-off valve

- While assembling two shut-off valves, pop sound will be heard when valve is open or close by rotating handles. It is normal condition because the sound is due to leakage of charged nitrogen gas inside the valve. The nitrogen gas is applied to secure quality assurance.
- Before starting water charging, these two shut-off valves should be assembled with water inlet and outlet pipe of the unit.

Water condensation on the floor

While cooling operation, it is very important to keep leaving water temperature higher than 16 °C. Otherwise, dew condensation can be occurred on the floor.

If floor is in humid environment, do not set leaving water temperature below 18 °C.

Water condensation on the radiator

While cooling operation, cold water may not flow to the radiator. If cold water enters to the radiator, dew generation on the surface of the radiator can be occurred.

Pipe Insulation

Purpose of water pipe insulation is :

- To prevent heat loss to external environment.
- To prevent dew generation on the surface of the pipe in cooling operation.
- To prevent pipe breakage by freeze at winter season.
- Minimum insulation thickness recommendations ensure correct operation of the product, but local regulations may vary and must be followed.

※ Insulation must be done at exterior water pipe, valve and other fittings between product and building.

Water Piping length (m)	Minimum insulation Thickness(mm)
<20	20
20~30	30
30~40	40
40~50	50

* $\lambda = 0.04 \text{ W/mk}$ (Thermal conductivity of pipe insulation)

Water Charging

For water charging, please follow below procedures.

- Step 1.** Open all valves of whole water circuit. Supplied water should be charged not only inside the unit, but also in the under floor water circuit, DHW water tank circuit, FCU water circuit, and any other water circuits controlled by the product.
- Step 2.** Connect supply water into drain valve and fill valve located at the side of the shut-off valve.

CAUTION

No water-leakage permitted at the drain and fill valve. Leakage-proof treatment which is described in previous section should be applied.

- Step 3.** Start to supply water. While supplying water, following should be kept.
- Pressure of supplying water should be pre-adjust value approximately.
 - For supplying water pressure, time to be taken from 0 bar to pre-adjust value should be more than 1 minute. Sudden water supply can yield water drain through safety valve.
 - Fully open the cap of air vent to assure air purging. If air is exist inside the water circuit, then performance degrade, noise at the water pipe, mechanical damage at the surface of electric heater coil.
 - Open both the air vent in the water pipe and the air vent in the pump.
- Step 4.** Stop water supplying when the pressure gauge located in front of the control panel indicates pre-adjust value.(For 3 Series)
Stop water supplying when the pressure located in remote control indicates pre-adjust value.(For 4 Series)
- Step 5.** Close drain valve and fill valve. Then wait for 20~30 seconds to observe water pressure being stabilized.
- Step 6.** If following conditions are satisfactory, then go to Next process(Pipe Insulation).
Otherwise, go to step 3.
- Pressure gage indicates pre-adjust value. Note that sometimes pressure in decreased after step 5 due to water charging inside expansion vessel.
 - No air purging sound is heard or no water drop are popping out from air vent.

CAUTION

Keep the air vent of the water pipe open and keep the air vent of the pump closed.
Otherwise, the pump may make noise.

Water pump Capacity

The water pump is variable type which is capable to change flow rate, so it may be required to change default water pump capacity in case of noise by water flow. In most case, however, it is strongly recommended to set capacity as Maximum.

NOTE

- To secure enough water flow rate, do not set water pump capacity as Minimum. It can lead unexpected flow rate error CH14.

Pressure Drop

NOTE

When installing the product, install additional pump in consideration of the pressure loss and pump performance. If flow rate is low, overloading of product can occur

(For GRUNDFOS Water Pump)

Capacity [kW]	Rated flow-rate [LPM(m ³ /h)]	Pump Head [m] (At rated flow rate)	Product pressure drop [m] (Plate heat exchanger)	Serviceable Head [m]
16	46.0 (2.8)	8.3	1.4	6.9
14	40.25 (2.4)	9.3	1.1	8.2
12	34.5 (2.1)	9.8	0.8	9.0
9	25.87 (1.5)	6.1	0.4	5.7
7	20.12 (1.2)	7.3	0.3	7.0
5	15.8 (0.9)	7.5	0.2	7.3

(For OH SUNG Water Pump)

Capacity [kW]	Rated flow-rate [LPM(m ³ /h)]	Pump Head [m] (At rated flow rate)	Product pressure drop [m] (Plate heat exchanger)	Serviceable Head [m]
16	46.0 (2.8)	8.5	1.4	7.1
14	40.3 (2.4)	9.1	1.1	8.0
12	34.5 (2.1)	9.7	0.8	8.9
9	25.9 (1.5)	10.3	0.4	9.9
7	20.1 (1.2)	10.7	0.3	10.4
5	15.8 (0.9)	10.9	0.2	10.7

Performance curve

GRUNDFOS Water Pump : UPML GEO 20 – 105 CHBL
UN60A (12, 14, 16 kW)

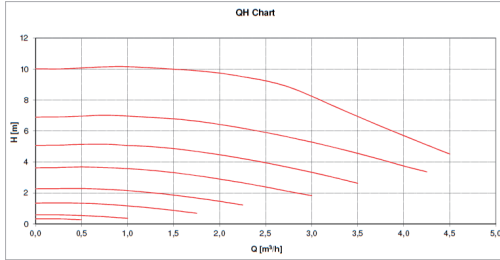

GRUNDFOS Water Pump : UPM3K GEO 20 – 75 CHBL
UN36A (5, 7, 9 kW), UN60A (9 kW)

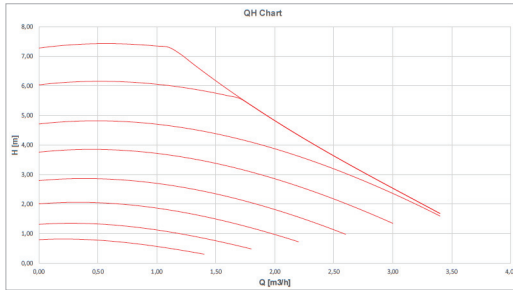

OH SUNG Water Pump : ODM-061P
UN60A (12, 14, 16 kW), UN36A (5, 7, 9 kW)

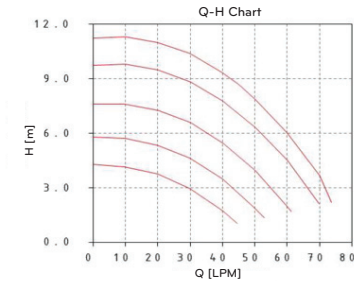

Performance test based on standard ISO 9906 with pre-pressure 2.0 bar and liquid temperature 20 °C.

⚠ WARNING

- Selecting a water flowrate outside the curves can cause damage to or malfunction of the unit.

Water Quality

Water quality should be complied with EN 98/83 EC Directives.
Detailed water quality condition can be found in EN 98/83 EC Directives.

CAUTION

- If the product is installed at existing hydraulic water loop, it is important to clean hydraulic pipes to remove sludge and scale.
- Installing sludge strainer in the water loop is very important to prevent performance degrade.
- Chemical treatment to prevent rust should be performed by installer.
- It is strongly recommended to install an additional filter on the heating water circuit. Especially to remove metallic particles from the heating piping, it is advised to use a magnetic or cyclone filter, which can remove small particles. Small particles may damage the unit and will NOT be removed by the standard filter of the heat pump system.

Frost protection by antifreeze

In areas of the country where entering water temperatures drop below 0 °C, the water pipe must be protected by using an approved antifreeze solution. Consult your AWHP unit supplier for locally approved solutions in your area. Calculate the approximate volume of water in the system. (Except the AWHP unit.) And add six liters to this total volume to allow for the water contained in AWHP unit.

Antifreeze type	Antifreeze mixing ratio					
	0 °C	-5 °C	-10 °C	-15 °C	-20 °C	-25 °C
Ethylene glycol	0 %	12 %	20 %	30 %	-	-
Propylene glycol	0 %	17 %	25 %	33 %	-	-
Methanol	0 %	6 %	12 %	16 %	24 %	30 %

If you use frost protection function, change DIP switch setting and input the temperature condition in Installation mode of remote controller. Refer to 'CONFIGURATION > DIP Switch Setting > DIP Switch Information > Option Switch 3' and 'INSTALLER SETTING > Antifreezing Temperature'.

CAUTION

- Use only one of the above antifreeze.
- If a antifreeze is used, pressure drop and capability degradation of the system can be occurred.
- If one of antifreezes is used, corrosion can be occurred. So please add corrosion inhibitor.
- Please check the concentration of the antifreeze periodically to keep same concentration.
- When the antifreeze is used (for installation or operation), take care to ensure that antifreeze must not be touched.
- Ensure to respect all laws and norms of your country about Anti-freeze usage.

Frost protection by antifreeze valve

About antifreeze valve



This is a valve to prevent freeze in winter. When no antifreeze is added to the water, you can use antifreeze valves at all lowest points of the field piping to drain the water from the system before it can freeze.

To install antifreeze valve

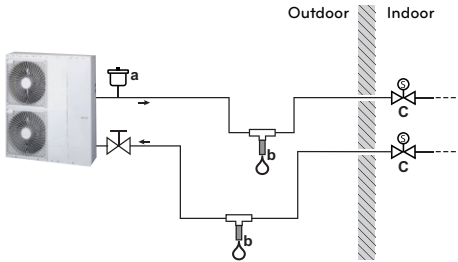
To protect the field piping against freezing, install the following parts:



- a Automatic air intake
- b Antifreeze valve (Optional – field supply)
- c Normally closed valves (recommended – field supply)

Part	Description
 a	An automatic air intake (for air supply) should be installed at the highest point. For example, an automatic air purge.
 b	Protection for the field piping. The antifreeze valve must be installed: <ul style="list-style-type: none"> • Vertically to allow water to flow out properly and free from obstructions. • At all lowest points of the field piping. • In the coldest part and away from heat sources.
 c	Isolation of water inside the house when there is a power interruption. Normally closed valves (located indoors near the piping entry/exit points) can prevent that all water from indoor piping is drained when the antifreeze valve open. <ul style="list-style-type: none"> • When there is a power interruption: The normally closed valves close and isolate the water inside the house. If the antifreeze valve open, only the water outside the house is drained. • In other circumstances (example: when there is a pump failure): The normally closed valves remain open. If the antifreeze valve open, the water from inside the house is also drained.

NOTE

- Do not make any trap connections. If the shape of the connection pipe has the potential to create a trap effect, part of the pipe will not be able to drain and frost protection will no longer be guaranteed.
- Leave at least 15 cm clearance from the ground to prevent ice from blocking the water exit.
- Keep a distance of at least 10 cm between the antifreeze valves.
- The valve must be free of insulation for the system to work properly.
- When antifreeze valves are installed, do NOT select a minimum cooling setpoint lower than 7 °C. If lower, antifreeze valves can open during cooling operation.
- When installed outdoors, the antifreeze valve must be protected from rain, snow and direct sunlight.

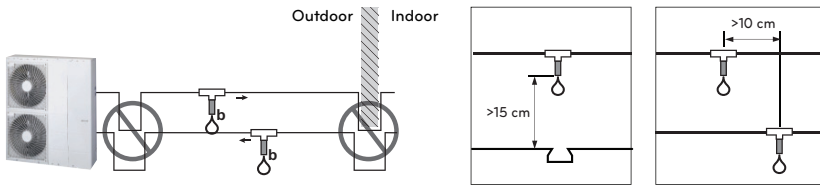

Water Volume and Expansion Vessel Pressure

Inside expansion vessel is included which is 8 liter capacity with 1 bar pre-pressure. That means, according to the volume-pressure graph, total water volume of 230 liter is supported as default. If total water volume is changed because of installation condition, the pre-pressure should be adjusted to secure proper operation.

If	Minimum water volume
The system contains a backup heater	20 L
The system does NOT contain a backup heater	80 L

* The internal water volume of the outdoor unit is NOT included

- Pre-pressure is adjusted by the total water volume. If the indoor is located at the highest position of the water circuit, adjustment is not required.
- To adjust pre-pressure, use nitrogen gas by certificated installer.

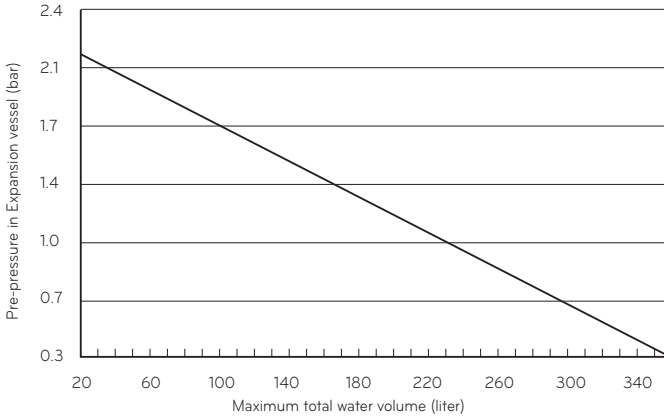

Adjusting pre-pressure of expansion vessel is as following :

- Step 1.** Refer "Volume-Height" table.
 If installation scene is belong to Case A, go to Step 2.
 Otherwise, if it is Case B, do nothing. (pre-pressure adjustment is not required.)
 Otherwise, if it is Case C, go to Step 3.
- Step 2.** Adjust pre-pressure by following equation.
 Pre-pressure [bar] = $(0.1 \times H + 0.3)$ [bar]
 where H : difference between unit and the highest water pipe
 0.3 : minimum water pressure to secure product operation
- Step 3.** Volume of expansion vessel is less than installation scene.
 Please install additional expansion vessel at the external water circuit.

Volume-Height Table

	V < 230 liter	V ≥ 230 liter
H < 7 m	Case B	Case A
H ≥ 7 m	Case A	Case C

H : Difference between unit and the highest water pipe
 V : Total water volume of installation scene

ACCESSORIES INSTALLATION

THERMAV. can interface to various accessories to extend its functionality and to improve user convenience. In this chapter, specifications about supported 3rd party accessories and how to connect to **THERMAV.** is introduced.

It is noted that this chapter only deal with 3rd party accessories. For accessories supported by LG Electronics, please refer to installation manual of each accessories.

Accessories supported by LG Electronics

Item	Purpose	Model
DHW Tank Install Kit	To operate with DHW tank	PHLTB
Thermistor for DHW Tank	To control hot water temperature of DHW tank	PHRSTA0
Remote Temperature Sensor	To control by air temperature	PQRSTA0
Dry Contact	To receive on & off external signal	PDRYCB000
	Dry contact for thermostat	PDRYCB300
Solar thermal Kit	To operate with solar heating system	PHLLA(Limit temperature : 96 °C)
Meter Interface	To measure production / consumption power	PENKTH000
Central Controller	Multiple installed products into one central control	AC EZ Touch (PACEZA000) AC Smart IV (PACS4B000) AC Smart 5 (PACS5A000) ACP 5 (PACP5A000) AC Manager 5 (PACM5A000)
Backup heater	To supplement insufficient capacity	HA031M E1 / HA061M E1 / HA063M E1 HA031M E2 / HA061M E2 / HA063M E2
Thermistor for 2nd Circuit	To interlock with 2nd circuit operation and control temperature of main zone.	PRSTAT5K10
Extension wire	To connect remote controller with Indoor PCB for communication	PZCWRC1
PI485	To communicate and control through the central controller	PP485A00T
ESS	To control the operation mode according to the energy storage state	HOME 8 (PCS) : D008KE1N211 HOME10(PCS) : D010KE1N211 HB7H(Battery) : BLGRESU7H HB10H(Battery) : BLGRESU10H

Item	Purpose	Model
DHW Tank	To generate and store hot water	OSHW-200F : 200 L, Single Heating Coil, 1Ø 230 V 50 Hz 2.4 kW Booster heater OSHW-300F : 300 L, Single Heating Coil, 1Ø 230 V 50 Hz 2.4 kW Booster heater OSHW-500F : 500 L, Single Heating Coil, 1Ø 230 V 50 Hz 2.4 kW Booster heater OSHW-300F : 300 L, Double Heating Coil, 1Ø 230 V 50 Hz 2.4 kW Booster heater
Cloud Gateway	To use Becon cloud	PWFMDB200
Wi-Fi Modem	To enable remote system operation from smartphone	PWFMD200
Extension cable for Wi-Fi Modem	To connect with Wi-Fi modem to the USB cable	PWYREW000
Thermistor for 2nd Circuit or E/Heater	To interlock with 2nd circuit operation and control temperature of main zone or To interlock with 3rd party E/Heater and control temperature of water out 3rd party E/Heater.	PRSTAT5K10
RS3 remote controller	To control unit with 2 remote controllers	PREMTW101
2-Remo Control Wire	The wire for 2 remo control	PZCWRC2

Accessories supported by 3rd party Companies

Item	Purpose	Specification
Solar Heating System	To generate auxiliary heating energy for water tank	<ul style="list-style-type: none"> • Solar collector • 3way valve(B)
Mix Kit	To use 2nd Circuit	<ul style="list-style-type: none"> • Mixing valve • Mix pump
3rd Party Boiler	To use auxiliary boiler.	
3rd Party Controller	To connect external controller using modbus protocol	
Thermostat	To control by air temperature	Heating-Only type (230 V AC) Cooling/Heating type (230 V AC with Mode selection switch)
3way valve and actuator	(A) : To control water flow for hot water heating or floor heating / To control water flow when installing 3rd party boiler (B) : To control close/open mode of solar circuit	3 wire, SPDT (Single Pole Double Throw) type, 230 V AC
2way valve and actuator	To control water flow for Fan Coil Unit / To serve as 3way valve when installing backup heater	2 wire, SPST (Single Pole Sing Throw) type, 230 V AC
External Pump	To retain sufficient capacity using additional pump	
Smart Grid	To control operation mode depending on input signal from provider	
3 rd Party ESS	To control the operation mode according to the energy storage state	(For 4 Series)
3 rd party Backup heater	To supplement in sufficient capacity	(For 4 Series)
Antifreeze valve	To protect the pipes against freezing	
DHW Recirculation Pump	To control the water flow of DHW recirculation pump	(For 4 Series)

Before Installation

! WARNING

Followings should be kept before installation

- Main power must be turned off during installing 3rd party accessories.
- 3rd party accessories should be comply with supported specification.
- Proper tools should be chosen for installation.
- Never do installation with wet hands.

Thermostat

Thermostat is generally used to control the product by air temperature. When thermostat is connected to the product, the product operation is controlled by the thermostat.

Installation condition

! CAUTION

- USE 220-240 V~ Thermostat
- Some electro-mechanical type thermostat has internal delay time to protect compressor. In that case, mode change can takes time more than user's expectation. Please read thermostat manual carefully if the unit does not response quickly.
- Setting temperature range by thermostat can be different with that of the unit. The heating or cooling set temperature should be chosen within the setting temperature range of the unit.
- It is highly recommended that the thermostat should be installed where space heating is mainly applied.

Following location should be avoid to secure proper operation :

- Height from floor is approximately 1.5 m.
- Thermostat can not be located where the area may be hidden when door is open.
- Thermostat can not be located where external thermal influence may be applied. (such as above heating radiator or open window)

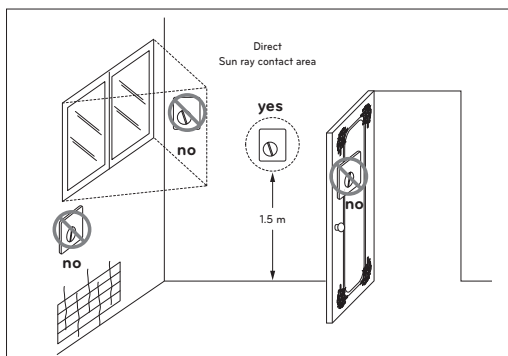

General Information

The Heat Pump supports following thermostats.

Type	Power	Operating Mode	Supported
Mechanical (1)	230 V~	Heating Only (3)	Yes
		Heating / Cooling (4)	Yes
		Heating / Cooling / DHW Heating (5)	Yes
Electrical (2)	230 V~	Heating Only (3)	Yes
		Heating / Cooling (4)	Yes
		Heating / Cooling / DHW Heating (5)	Yes

- (1) There is no electric circuit inside the thermostat and electric power supply to the thermostat is not required.
- (2) Electric circuit such as display, LED, buzzer, etc is included in the thermostat and electric power supply is required.
- (3) Thermostat generates "Heating ON or Heating OFF" signal according to user's heating target temperature.
- (4) Thermostat generates both "Heating ON or Heating OFF" and "Cooling ON or Cooling OFF" signal according to user's heating and cooling target temperature.
- (5) Thermostat generates "Heating ON or Heating OFF", "Cooling ON or Cooling OFF", "DHW Heating ON or DHW Heating OFF" signal according to user's heating, cooling and DHW heating target temperature. (For Split Indoor unit 5 Series, For Hydrosplit)



CAUTION

Choosing heating / cooling thermostat

- Heating / cooling thermostat must have "Mode Selection" feature to distinguish operation mode.
- Heating / cooling thermostat must be able to assign heating target temperature and cooling target temperature differently.
- If above conditions are not kept, the unit can not operation properly.
- Heating / cooling thermostat must send cooling or heating signal immediately when temperature condition is satisfied. No delay time while sending cooling or heating signal is permitted.

How to wire thermostat (For 3 series)

Follow below procedures Step 1 ~ Step 5.

Step 1. Uncover front cover of the unit and open the control box.

Step 2. Identify the power specification of the thermostat. If it is 220-240 V~, go to Step 3.

Step 3. If it is Heating only thermostat, go to step 4. Otherwise, if it is Heating / cooling thermostat, go to step 5.

Step 4. Find terminal block and connect wire as below.

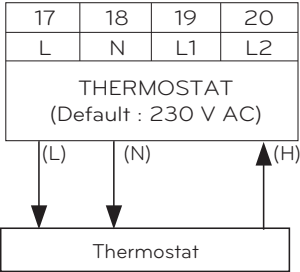

! WARNING

Mechanical type thermostat

Do not connect wire (N) as mechanical type thermostat does not require electric power supply.

! CAUTION

Do not connect external electric loads.

Wire (L) and (N) should be used only for operation electric type thermostat.

Never connect external electric loads such as valves, fan coil units, etc. If connected, Main PCB (Heater) can be seriously damaged.

(L) : Live signal from PCB to thermostat

(N) : Neutral signal from PCB to thermostat

(H) : Heating signal from thermostat to PCB

※ The terminal block connection number may differ depending on the model. Refer to the "Wiring Diagram" in the SVC Manual.

Step 5. Find terminal block and connect wire as below.

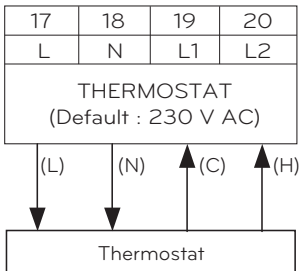

! WARNING

Mechanical type thermostat

Do not connect wire (N) as mechanical type thermostat does not require electric power supply.

! CAUTION

Do not connect external electric loads.

Wire (L) and (N) should be used only for operation Electric type thermostat.

Never connect external electric loads such as valves, fan coil units, etc. If connected, Main PCB (Heater) can be seriously damaged.

(L) : Live signal from PCB to thermostat

(N) : Neutral signal from PCB to thermostat

(C) : Cooling signal from thermostat to PCB

(H) : Heating signal from thermostat to PCB

How to wire Heating / Cooling / DHW Heating thermostat (For 4 Series)

Follow below procedures Step 1 ~ Step 3.

Step 1. Uncover front cover of the unit and open the control box.

Step 2. Identify the power specification of the thermostat. If it is 220-240 V~, go to Step 3.

Step 3. Find terminal block and connect wire as below.

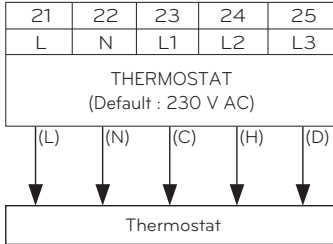

(L) : Live signal from PCB to thermostat

(N) : Neutral signal from PCB to thermostat

(C) : Cooling signal from thermostat to PCB

(H) : Heating signal from thermostat to PCB

(D) : DHW Heating signal from thermostat to PCB

! WARNING

Mechanical type thermostat.

Do not connect wire (N) as mechanical type thermostat does not require electric power supply.

! CAUTION

Do not connect external electric loads.

Wire (L) and (N) should be used only for operation electric type thermostat.

Never connect external electric loads such as valves, fan coil units, etc. If connected, Main PCB (Heater) can be seriously damaged.

Final check

- DIP switch setting :
Set DIP switch No. 8 to 'ON'. Otherwise, the unit can not recognize the thermostat.
- Remote Controller :
 - 'Thermostat' text is displayed on the remote controller.
 - Only the water temperature setting is available and the other button input is prohibited.
 - In case of Heating / Cooling / DHW Heating thermostat, select 'Heat&Cool / DHW' as the Thermostat Control Type in the remote controller installer settings.
 - The product operates according to Thermo On / Off conditions of the thermostat and remote controller.

Thermo On / Off Condition		Product
Thermostat	Remote Controller	
Thermo Off	Thermo Off	Thermo Off
Thermo Off	Thermo On	Thermo Off
Thermo On	Thermo Off	Thermo Off
Thermo On	Thermo On	Thermo On

2nd Circuit

The 2nd circuit is a function that can separately control the circuit1 requiring high temperature and the circuit 2 requiring medium temperature, you need to prepare a separate Mix Kit. The mix kit must be installed in the circuit 2.

- For 3 Series

[Install Guide 2nd Circuit Heating]

Circuit 1 \ Circuit 2	Floor (35 °C)	Convector (FCU, 45 °C)	Radiator (45 °C)	Radiator (55 °C)
Floor (35 °C)	○	X	X	X
Convector (FCU, 45 °C)	○	○	○	X
Radiator (45 °C)	○	○	○	○
Radiator (55 °C)	○	○	○	○

[Install Guide 2nd Circuit Cooling]

Circuit 1 \ Circuit 2	Floor (18 °C)	Convector (FCU, 5 °C)
Floor (18 °C)	○	X
Convector (FCU, 5 °C)	X	○

※ To use a floor combination during cooling operation, the flow through the floor of the flow must be blocked by the 2 way valve.

※ For detailed 2nd circuit remote control settings, refer to 'Add Zone' under [Chapter 8]

NOTE

Circuit 1 = Direct circuit : Zone where the water temperature is Highest when heating

Circuit 2 = Mixing circuit : The other zone

The 2nd circuit is a function that can separately control the circuit1 requiring high temperature and the circuit 2 requiring medium temperature, you need to prepare a separate Mix Kit. The mix kit must be installed in the circuit 2.

- For 4 Series

[Install Guide 2nd Circuit Heating]

Circuit 1 \ Circuit 2	Floor (35°C)	Convector (FCU, 45 °C)	Radiator (45 °C)	Radiator (55 °C)
Floor (35 °C)	○	○	○	○
Convector (FCU, 45 °C)	○	○	○	○
Radiator (45 °C)	○	○	○	○
Radiator (55 °C)	○	○	○	○

[Install Guide 2nd Circuit Cooling]

Circuit 1 \ Circuit 2	Floor (18 °C)	Convector (FCU, 5 °C)
Floor (18 °C)	○	○
Convector (FCU, 5 °C)	○	○

* To use a floor combination during cooling operation, the flow through the floor of the flow must be blocked by the 2 way valve.

* For detailed 2nd circuit remote control settings, refer to 'Mixing Circuit' under [Chapter 8]

NOTE

Circuit 1 = Direct circuit : Zone where the water temperature is Highest when heating

Circuit 2 = Mixing circuit : The other zone

How to Wire Mix Pump, Mixing Valve and Thermistor for 2nd Circuit

- For 3 Series

Follow below procedures Step 1 ~ Step 3.

Step 1. Uncover front cover of the unit.

Step 2. Find terminal block and connect wire as below

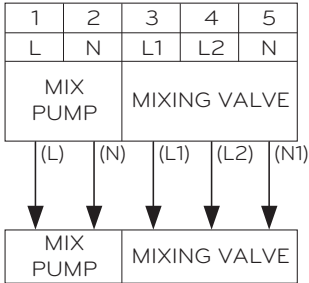

(L) : Live signal from PCB to mix pump

(N) : Neutral signal from PCB to mix pump

(L1) : Live signal (for Normal* Closed type) from PCB to mixing valve

(L2) : Live signal (for Normal Open type) from PCB to mixing valve

(N1) : Neutral signal from PCB to mixing valve

*Closed = NOT Mixed

※ The terminal block connection number may differ depending on the model. Refer to the "Wiring Diagram" in the SVC Manual.

Step 3. Insert the temperature sensor to 'CN_MIX_OUT' (Brown) of the main PCB as shown below. The sensor should be mounted correctly to outlet pipe of mix kit water pump as shown below.

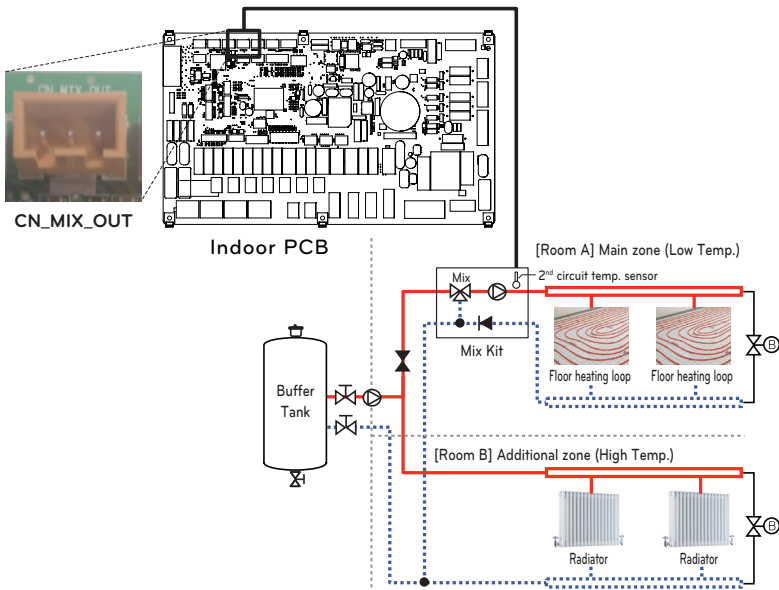

CAUTION

When connecting a pump of 1.05A or higher, its output must be used as a signal line only.

- For 4 Series

Follow below procedures Step 1 ~ Step 3.

Step 1. Uncover front cover of the unit.

Step 2. Find terminal block and connect wire as below

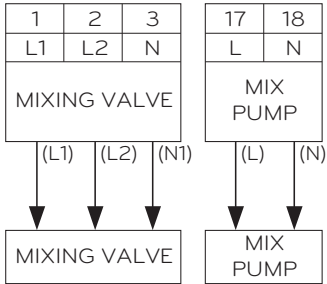

(L) : Live signal from PCB to mix pump

(N) : Neutral signal from PCB to mix pump

(L1) : Live signal (for Normal* Closed type) from PCB to mixing valve

(L2) : Live signal (for Normal Open type) from PCB to mixing valve

(N1) : Neutral signal from PCB to mixing valve

*Closed = NOT Mixed

Step3. Insert the temperature sensor to 'CN_MIX_OUT' (Brown) of the main PCB as shown below. The sensor should be mounted correctly to outlet pipe of mix kit water pump as shown below.

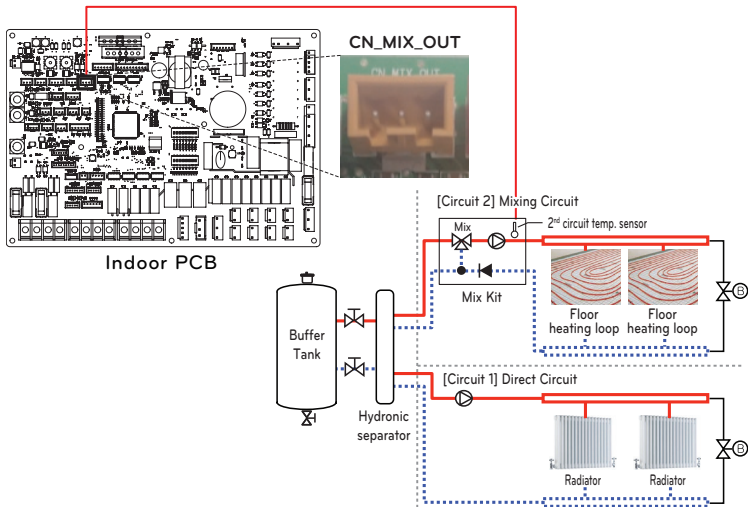
**NOTE**

2nd circuit temp. sensor is an accessory. (Model: PRSTAT5K10)

CAUTION

When connecting a pump of 1.05A or higher, its output must be used as a signal line only.

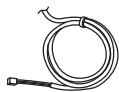
[Thermistor for 2nd circuit]

Sensor



Sensor Holder



Sensor Connector

Follow below procedures step 1 ~ step 4.

Step 1. Install sensor connector to outlet pipe of mix kit water pump.

(Welding must be performed to connect the sensor connector to the pipe.)

Step 2. Check if the power of the unit is turned off.

Step 3. Fasten the sensor connector to the sensor holder as shown in the figure below.

Step 4. Insert harness into PCB(CN_TH4) fully and fix the thermal sensor into tube connector as shown below.

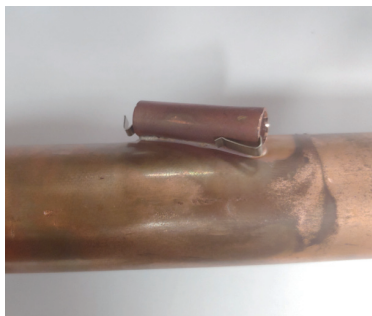

3rd Party Boiler

The product can be used by connecting an Auxiliary boiler. You can control the boiler automatically and manually by comparing the outside temperature and the set temperature.

How to install 3rd party boiler

Follow below procedures step 1 ~ step 3.

Step 1. Check if the power of the unit is turned off.

Step 2. Disassemble front panels and Distinguish terminal block in Indoor PCB.

Step 3. Connect Power cable to terminal block (TB_BOILER) fully.

- For 3 Series

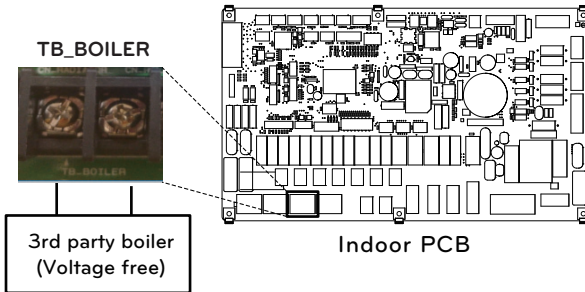

- For 4 Series

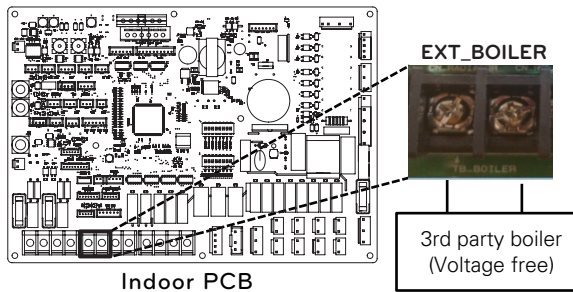

3rd Party Controller

The product can also be linked to 3rd party controller. You can connect external controllers using Modbus protocol except for LG controller. If 3rd party controller is used, LG controller is not applied to AWHP simultaneously.

How to install 3rd party controller

Follow below procedures step 1 ~ step 4.

Step 1. Check if the power of the unit is turned off.

Step 2. Disassemble front panels and distinguish control box(Indoor) of the unit.

Step 3. Check if the harness(White) is inserted fully to the indoor unit PCB (CN_COM).

Step 4. Connect the 3rd party controller to terminal block 2(11/12) completely. (including Meter interface module)

- For 3 Series

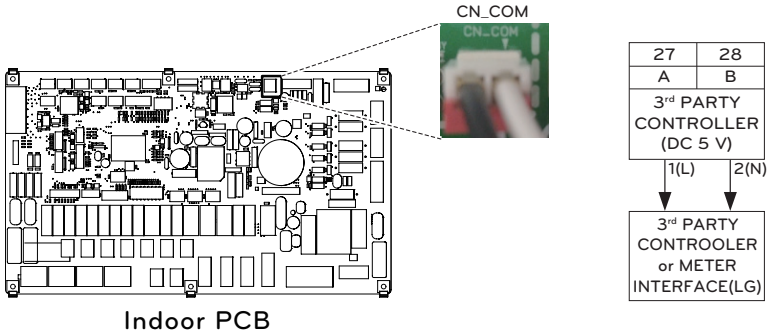

- For 4 Series

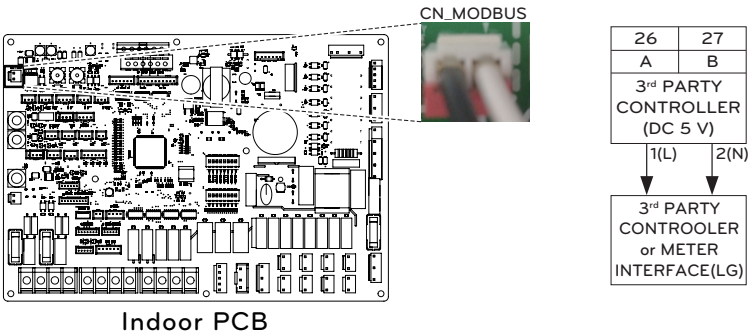

Meter Interface

This product can be used by connecting the meter interface module supplied in the field. The meter interface module can communicate with the wired remote controller. The meter interface module lets you know the amount of power generated by the product.

How to install Meter Interface

[Parts of Meter interface]

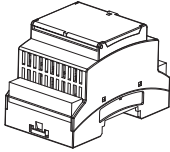

Meter interface body

Follow below procedures step 1 ~ step 4.

Step 1. Check if the power of the unit is turned off.

Step 2. Disassemble front panels and Distinguish control box(Indoor) of the unit.

Step 3. Check if the harness(White) is inserted fully to the indoor unit PCB (CN_COM).

Step 4. Connect the external pump to terminal block 2(11/12).

- For 3 Series

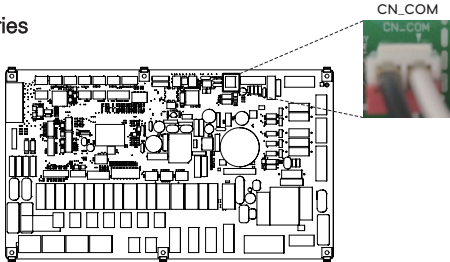

Indoor PCB

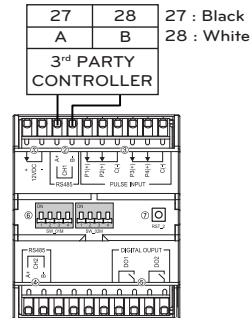

Meter interface

- For 4 Series

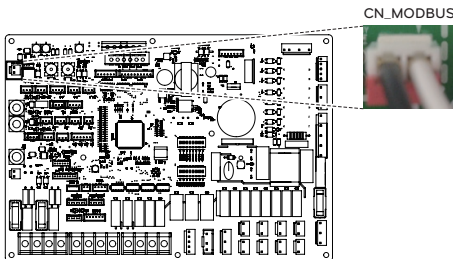

Indoor PCB

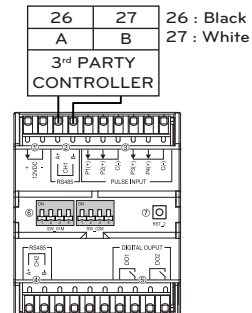

Meter interface

Central Controller

The product can communicate and control through the central controller. The following functions can be controlled in the central control linked state (Operation/Stop, Desired temperature, Hot water operation / stop, Warm water temperature, Full lock, Etc)

How to Install Central Controller

To use central controller, you need to establish an environment for mutual communication between central controller and the **THERMAV**, and register the corresponding devices through the functions of central controller. To use central controller, it shall be installed in the following order.

Step 1. Installation environment inspection and device address setting

Before installing central controller, check the network for any interfacing devices and assign non overlapping addresses to the connected devices.

Step 2. PI485 setting

Install PI485 and set the DIP switch accordingly.

Step 3. Connections

Connect PI485 and central controller through RS-485 cable.

Step 4. Access and Device Registration

Log in to central controller and register device with address set.

Consult a qualified engineer/ technician for the installation of central controller. If you have any installation queries, contact the LG service center or LG Electronics.

How to Installation PI485

Fix the PI485 PCB as shown in below images.

For detailed installation method refer to PI485 Installation Manual

UN60A (9, 12, 14, 16 kW)

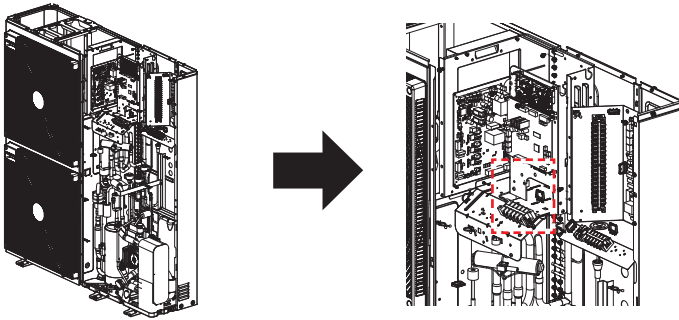

UN36A (5, 7, 9 kW)

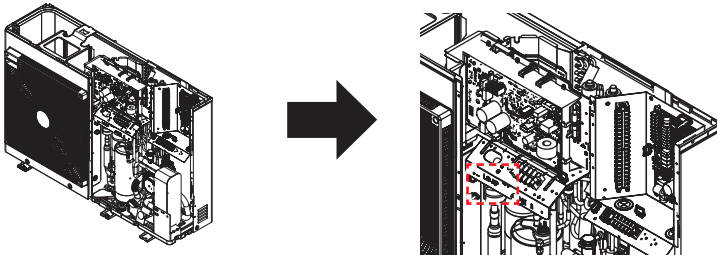

- For detailed installation instructions, refer to the manual included in the accessories.
- The shape may differ depending on the model.

Remote Controller

Installation of Remote Controller

- After fixing the remote controller installation plate on the desired location, fix it firmly with the provided screws.
 - If the installation plate is not flat on the surface, it may result in the controller being twisted and cause a defect.
 - If there is a mounting box, install the remote controller installation plate using the fixings holes which suit, as in the below diagrams.
 - Do not leave a gap with the wall or product loose after the installation.
 - If you are using the air temperature sensor in the remote control, refer to the Remote Temperature sensor guide.

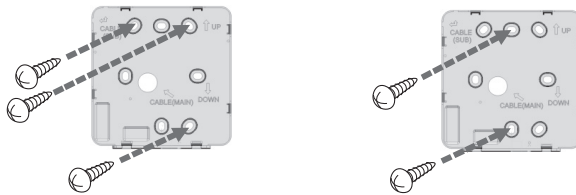

- The wired remote controller cable can be installed in 3 directions. Install to the suitable direction according to the installation environment.
 - Installation direction: Rear entry, top side, right side
 - When you install the remote controller cable at the top side and right side, remove the remote controller cable guide hole before the installation.
 - ※ Use a long nose pliers to remove the guide hole.
- After removing the hole, trim the cut surface neatly.

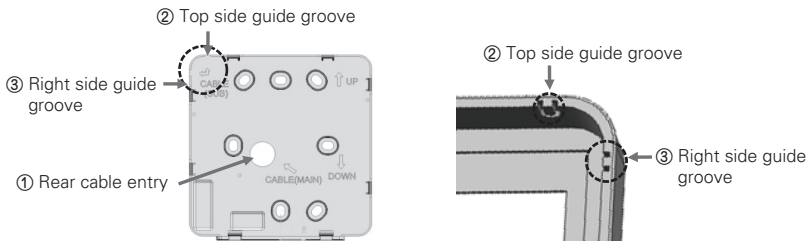

- After fixing the remote controller top side on the installation plate attached to the wall as in the following figure, press the bottom side to combine with the installation plate.
 - Do not leave a gap in the top, bottom, left, and right side of the remote controller and the installation plate after combining them.
 - Before combining with the installation plate, arrange the cables to avoid interference with the circuit parts.

<Procedure of Combining>

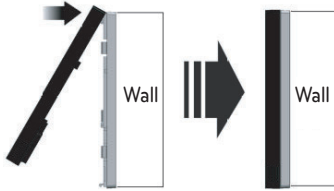

- When you remove the remote controller from the installation plate, insert a small flat head screwdriver into the bottom side separation hole and turn clockwise to separate the remote controller.
 - There are 2 separation holes at the bottom part. Slowly separate one by one.
 - Be careful not to damage the internal parts during the removal.

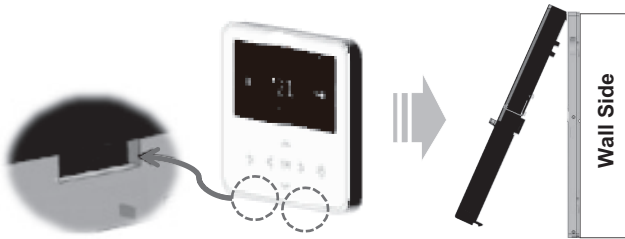

- Use the connection cables to connect the indoor unit with the remote controller.

DC 12 V	Red
Signal	Yellow
GND	Black

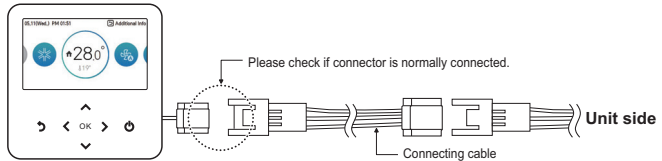

- For the following cases, separately purchase and use the cables suitable for the situation.
 - Do not install the cable over 50 m. (It may cause communication issues.)
 - If the distance between the wired remote controller and the unit is 10 m or more : 10 m extension cable (model name: PZCWRC1)

NOTE

During the wired remote controller installation, do not bury it in the wall. (It may cause temperature sensor failure.)

Do not install the cable over 50 m. (It may cause communication defect.)

When you install the extension cable, carefully check the direction of the connectors on the remote controller side and the product side before the installation.

Specification of extension cable: AWG 24, 3 conductor or above.

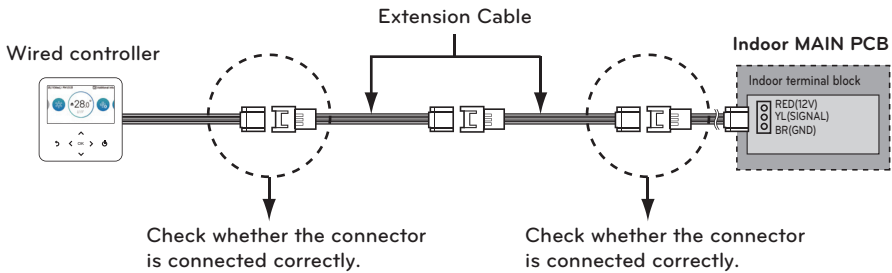
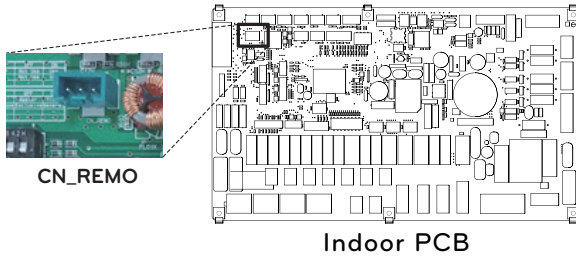

Cable connection method to use external device

1) Wired remote controller-cable connection method.

- In the wired remote controller, connect the part marked in the following figure (J02C, DO-Port) to the cable.
- According to the installation environment, there are 3 directions (Rear entry, top side, and right side) for the installation.

2) Cable extension connection method

- Among the cables connected to the wired remote controller, cut the remaining connectors on the other side, and then extend and connect the cables
- Extension cable specification: 24~26 AWG.

CAUTION

For the External device connection, use the cable insulated with sheath for the extension connection.

Before combining with the installation plate, arrange the cables to avoid interference with the internal parts.

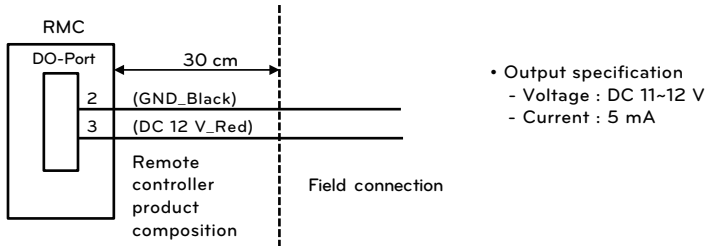

DHW Tank

To establish DHW circuit, 3way valve and DHW tank kit is required. If solar thermal system is pre-installed at the installation field, solar thermal kit is required to interface solar thermal system – to – DHW tank – to – **THERMAV**.

Installation condition

Installing DHW water tank requires following considerations :

- DHW water tank should be located at the flat place.
- Water quality should be complied with EN 98/83 EC directives.
- As this water tank is DHW water tank (indirect heat exchange), do not use anti water-freezing treatment like ethylene glycol.
- It is highly recommend to wash out inside of the DHW water tank after installation. It ensures generating clean hot water.
- Near the DHW water tank there should be water supply and water drain to easy access and maintenance.
- Set the maximum value of the temperature control device of DHW tank.

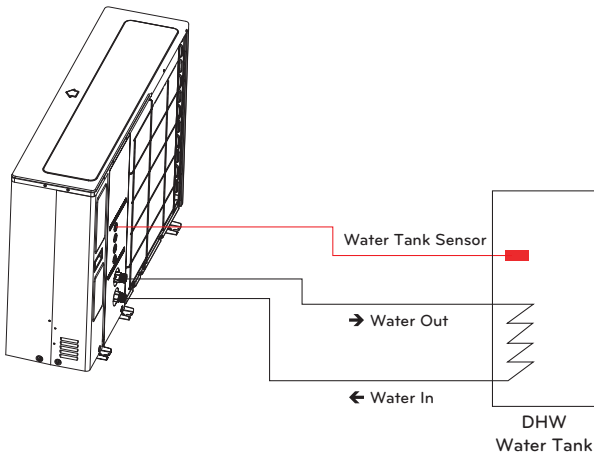

General Information

THERMAV supports following 3way valve.

Type	Power	Operating Mode	Supported
SPDT ¹⁾ 3-wire	230 V AC	Selecting Flow A ²⁾ between Flow A and Flow B	Yes
		Selecting Flow B ³⁾ between Flow A and Flow B	Yes

1. SPDT = Single Pole Double Throw. Three wires consist of Live1 (for selecting Flow A), Live 2 (for selecting Flow B), and Neutral (for common).

2. Flow A means water flow from the unit to under floor water circuit.

3. Flow B means water flow from the unit to DHW tank.

Installing recirculation pump

- For 3 Series

When **THERMAV** is used with DHW tank, it is **STRONGLY** recommended to install recirculation pump to prevent flooding out cold water at the end of hot water supply and to stabilize the water temperature inside DHW tank

- The recirculation pump should be operated when DHW demand is not required. Therefore, external time scheduler to determine when the recirculation pump should turn on and turn off is required.

- The operating duration time of the recirculation pump is calculated as follow :

$$\text{Duration time [minute]} = k \times V / R$$

k : 1.2 ~ 1.5 is recommended. (If distance between pump and tank is far, then choose high number)

V : Volume of DHW water tank [liter]

R : Water flow rate of pump [liter per minute], which is determined by pump performance curve

- The pump operating start time should be prior to the DHW water demand.

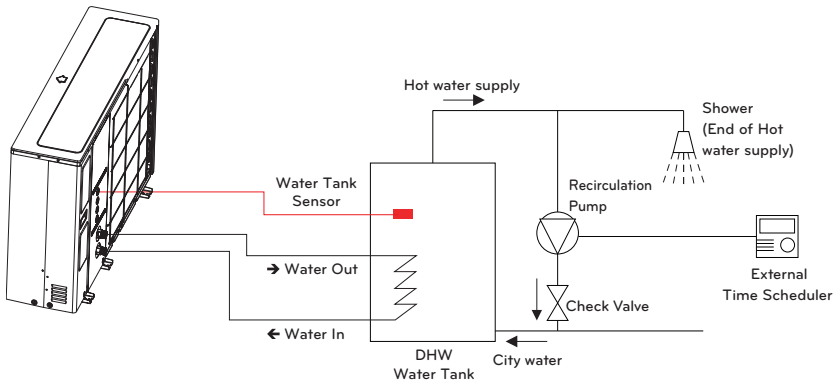

※ Water In / Water Out installation scene may vary depending on the model.

- For 4 Series

When **THERMAV** is used with DHW tank, it is **STRONGLY** recommended to install recirculation pump to prevent flooding out cold water at the end of hot water supply and to stabilize the water temperature inside DHW tank

- The recirculation pump should be operated when DHW demand is not required. Therefore, external time scheduler to determine when the recirculation pump should turn on and turn off is required.

- The operating duration time of the recirculation pump is calculated as follow :

$$\text{Duration time [minute]} = k \times V / R$$

k : 1.2 ~ 1.5 is recommended. (If distance between pump and tank is far, then choose high number)

V : Volume of DHW tank [liter]

R : Water flow rate of pump [liter per minute], which is determined by pump performance curve.

- The pump operating start time should be prior to the DHW demand.

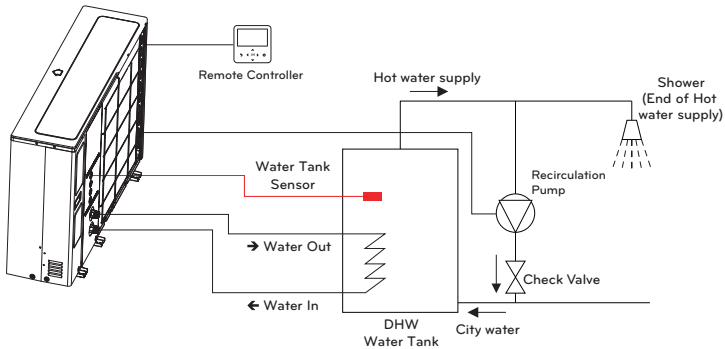

* Water In / Water Out installation scene may vary depending on the model.

How to wire recirculation pump

Follow below procedures step 1 ~ step 4.

Step 1. Check if the power of the unit is turned off.

Step 2. Disassemble front panels and distinguish control box(Indoor) of the unit.

Step 3. Check if the harness(Violet) is inserted fully to the indoor unit PCB (CN_PUMP_A15).

Step 4. Connect the DHW recirculation pump to terminal block 1(3/4).

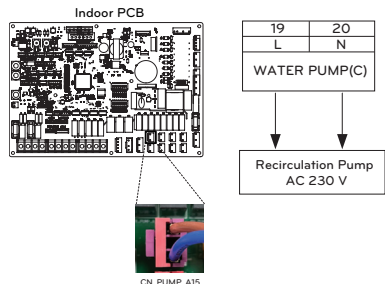

CAUTION

When connecting a pump of 1.05A or higher, its output must be used as a signal line only.

How to Wire Booster Heater

Step 1. Uncover heater cover of the DHW tank. It is located side of the tank.

Step 2. Find terminal block and connect wires as below. Wires are field-supplied item.

(L) : Live signal from PCB to Heater.

(N) : Neutral signal from PCB to Heater.

⚠ WARNING

Wire specification

- Cross-sectional area of the wire should be 6 mm².

Adjusting thermostat temperature

- To guarantee proper operation, it is recommended to set temperature of thermostat to maximum temperature (symbol $\text{\textcircled{A}}$ at the picture).

- 1Ø Backup Heater Model and 3Ø Backup Heater Model are set by same method as below.

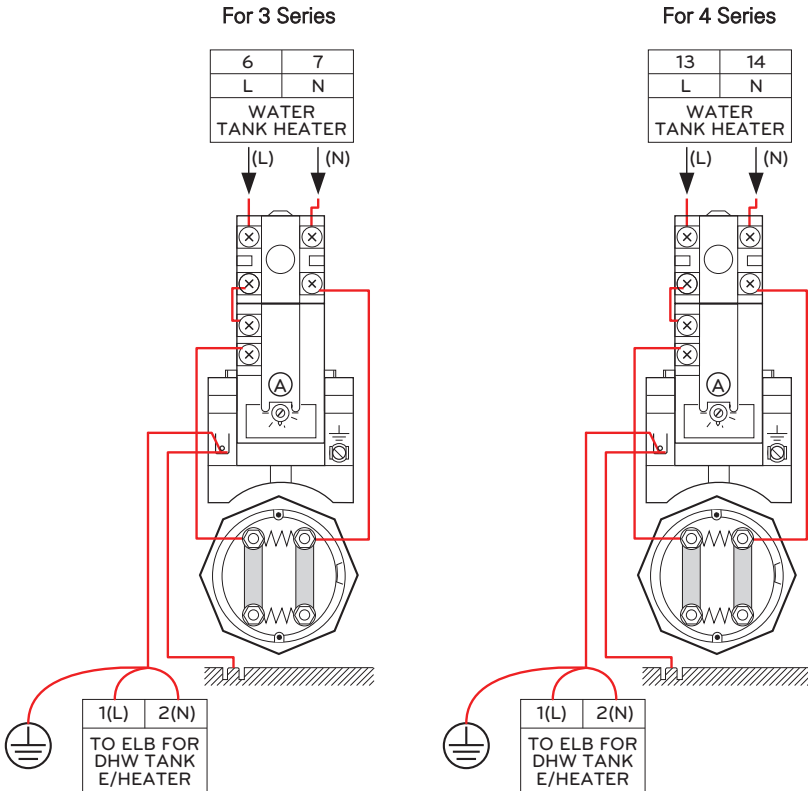

How to Wire DHW Tank Heater

Step 1. Uncover heater cover of the DHW tank. It is located side of the tank.

Step 2. Find terminal block and connect wires as below. Wires are field-supplied item.

(L) : Live signal from PCB to Heater

(N) : Neutral signal from PCB to Heater

WARNING

Wire specification

- Cross-sectional area of the wire should be 6 mm².

Adjusting thermostat temperature

- To guarantee proper operation, it is recommended to set temperature of thermostat to maximum temperature (symbol at the picture).
- 1Ø Electric Heater Model and 3Ø Electric Heater Model are set by same method as below.

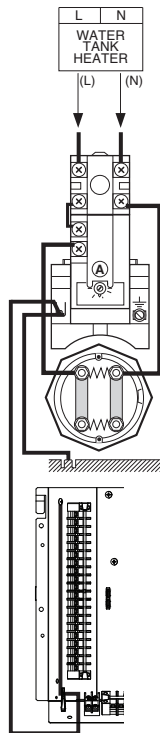

DHW Tank Kit

This product can be used by connecting the DHW tank kit in the field. It can be utilized hot water heated by booster heater in DHW tank.

How to install DHW tank kit

[Parts of DHW Tank Kit]

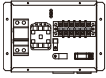

Tank kit body



Sensor

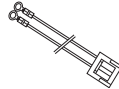

Multi harness

Temperature sensor for DHW tank is used to control hot water temperature of DHW tank. If sensor will be defective, you can purchase it separately.(Model name : PHRSTA0)

Follow below procedures step 1 ~ step 4.

Step 1. Uncover DHW tank kit and locate it on the wall.

Step 2. Connect Harness(Violet) of Main PCB assembly(TB1(6/7)) to 'CN_B_Heat_A' of the Main PCB like following fig. 1.

Step 3. Insert DHW tank sensor to 'CN_TH4' (Red) of the Main PCB refer as below.

Step 4. Connect power supply to the DHW tank kit as shown fig. 1.

※ The sensor should be mounted correctly to the sensor hole of DHW water tank like below fig. 2.

- For 3 Series

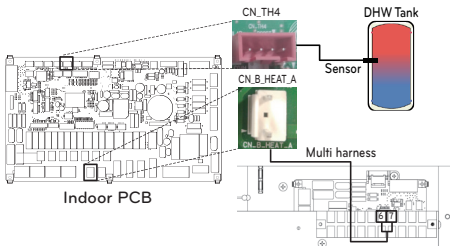

Fig. 1

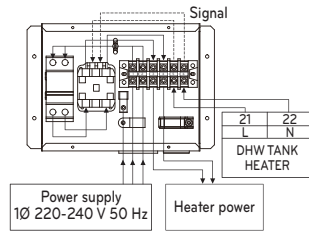
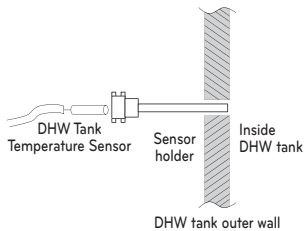

Fig. 3



Insert sensor until the cable tie as shown below.

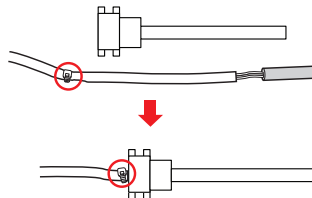
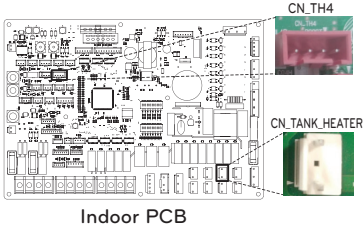

Fig. 2

※ The terminal block connection number may differ depending on the model. Refer to the "Wiring Diagram" in the SVC Manual.

- For 4 Series



Indoor PCB

Fig. 1

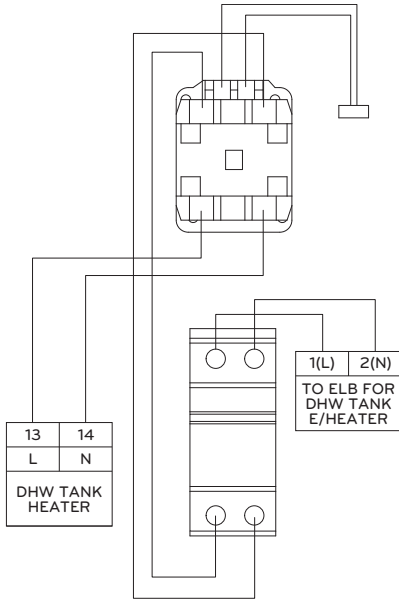

Solar Thermal Kit (For 3 Series)

This product can be used by connecting the solar thermal kit in the field. It can be utilized hot water heated by solar thermal system. End-user must be LG AWHP solar thermal kit.

How to Install Solar Thermal Kit

[Parts of Solar Thermal Kit]



Holder sensor

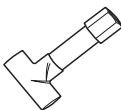

Tube Connector



Solar Thermal Sensor
12 m(1 EA)

Follow below procedures step 1 ~ step 4.

Step 1. Install tube connector(it is necessary to reduce or extend diameter of pipe.) the pipe and solar thermal kit.

Step 2. Check if the power of the unit is turned off.

Step 3. Disassemble front panels and distinguish control box(Indoor) of the unit.

Step 4. Insert harness into PCB(CN_TH4) fully and fix the thermal sensor into tube connector as shown below.

※ If the DHW tank sensor is connected, disconnect the sensor from PCB first.

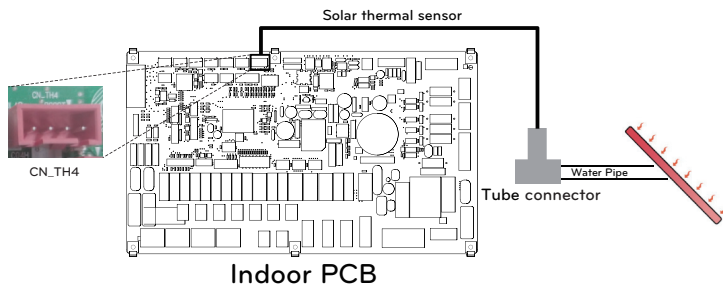

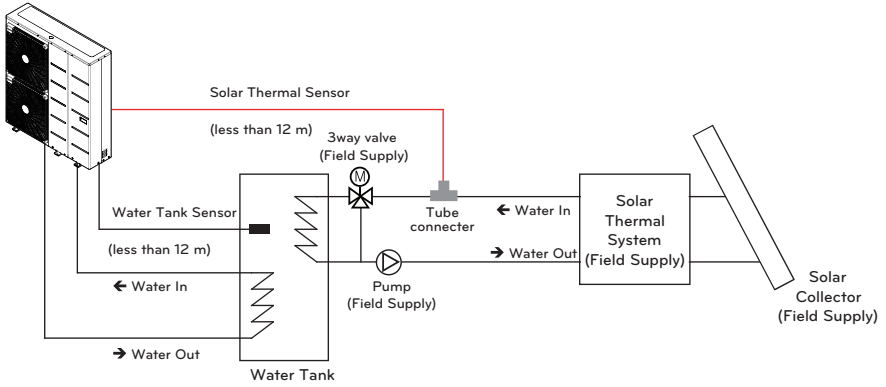

* Water In / Water Out installation scene may vary depending on the model.

- Insert sensor until the cable tie as shown below.



CAUTION

Sensor mounting

Insert sensor into sensor socket and bolt it tightly.

Solar Thermal Kit (For 4 Series)

This product can be used by connecting the solar thermal kit in the field. It can be utilized hot water heated by solar thermal system.

How to Install Solar Thermal System

Follow below procedures step 1 ~ step 3.

Step 1. Check if the power of the unit is turned off

Step 2. Disassemble front panels and distinguish control box(Indoor) of the unit.

Step 3. Insert harness into PCB fully and fix the thermal sensor.

※ Solar Thermal Sensor : PT1000 (Field Supply)

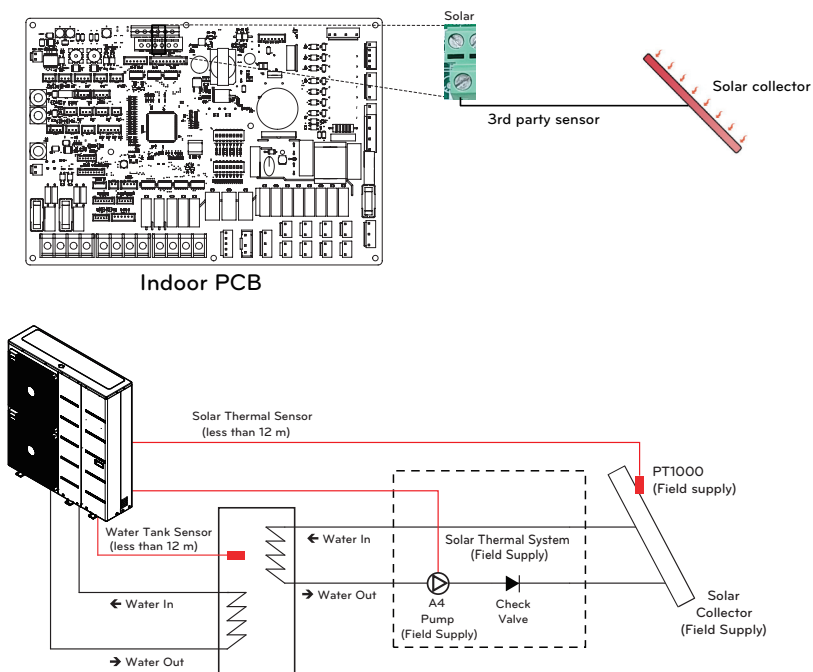

※ Water In / Water Out installation scene may vary depending on the model.

Dry Contact

Dry Contact is a solution for automatic control of HVAC system at the owner's best. In simple words, it's a switch which can be used to turn the unit On/Off after getting the signal from external sources.

How to install dry contact

[Parts of Dry contact]

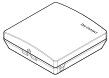

Dry Contact body



Cable(for connecting with IDU)

Follow below procedures step 1 ~ step 4.

Step 1. Check if the power of the unit is turned off.

Step 2. Disassemble front panels and distinguish terminal block in Indoor PCB.

Step 3. Connect cable to the unit PCB(CN_CC) fully.

Step 4. Then, Insert harness to the dry contact PCB(CN_INDOOR) firmly as shown below.

- For 3 Series

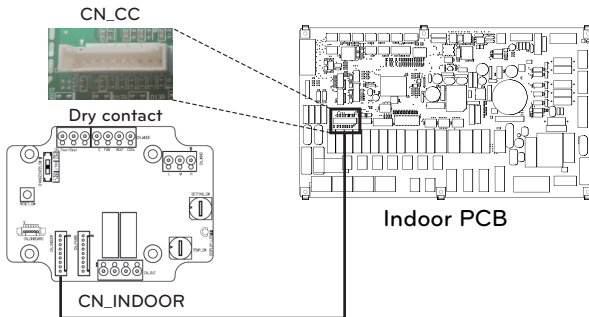

- For 4 Series

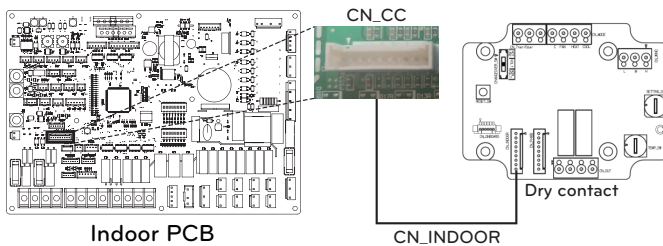

NOTE

- For more information about installing Dry Contact, Please refer installation manual provided with Dry Contact.
- For more settings about Dry Contact, Please refer to "Dry Contact Mode / CN_CC / CN_EXT" that installer setting part

[Setting of Contact Signal Input]

- For input contact closure only (No power input)

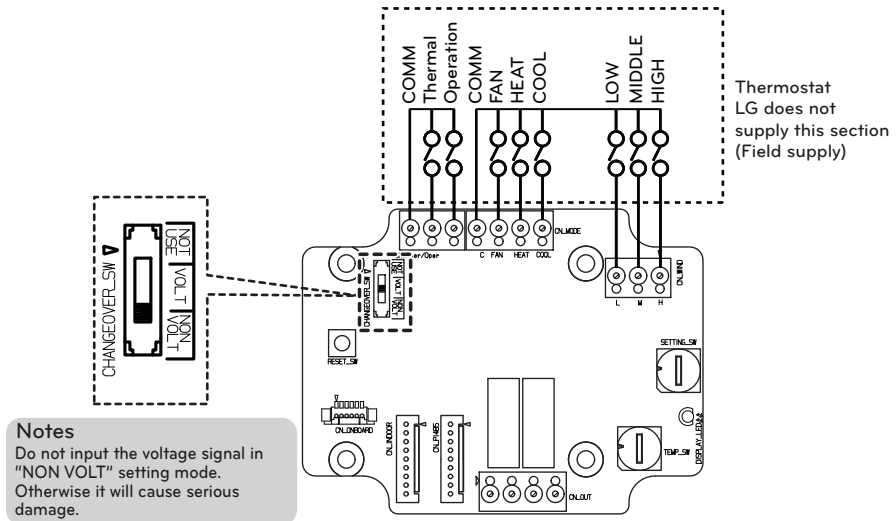

- For input contact voltage : DC 12 V, 24 V~

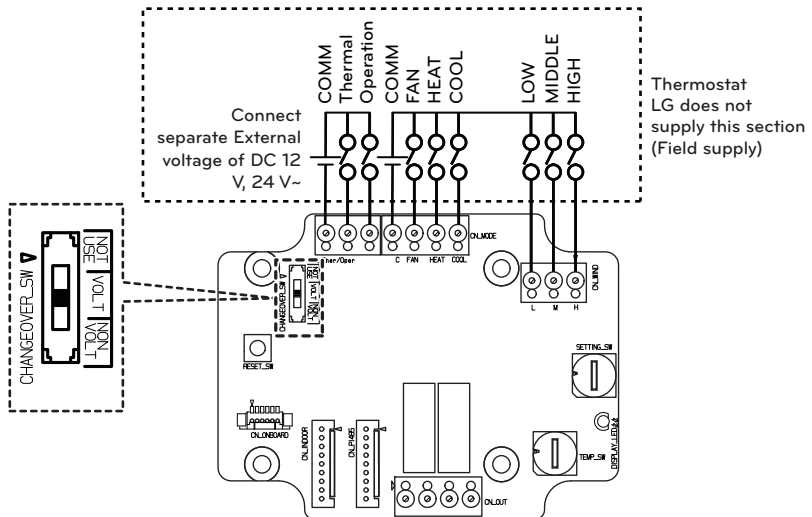

Setting_SW Setting

- Normal (0) : Possible to be controlled by the remote controller
- Forced (1) : Not possible to be controlled by the remote controller
- There is no OPER_SW setting that each input signal is disabled.

External Controller - Setting up programmable digital input operation

If you require to operate control depending on external digital input(ON/OFF), connect cable to indoor PCB(CN_EXT).

Follow below procedures step 1 ~ step 4.

Step 1. Check if the power of the unit is turned off.

Step 2. Disassemble front panels and distinguish control box(Indoor) of the unit

Step 3. Connect the external controller to PCB(CN_EXT) completely.

Step 4. Connect the cable and field installation part.

- For 3 Series

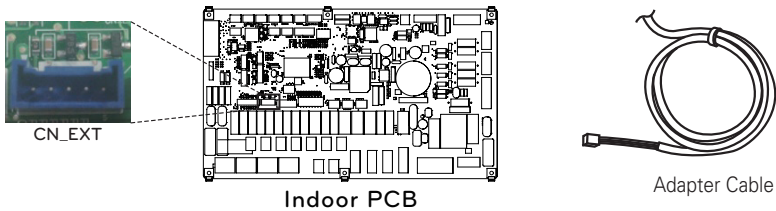

- For 4 Series

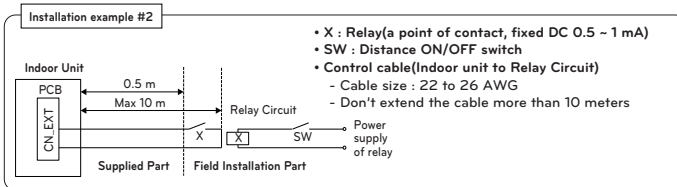
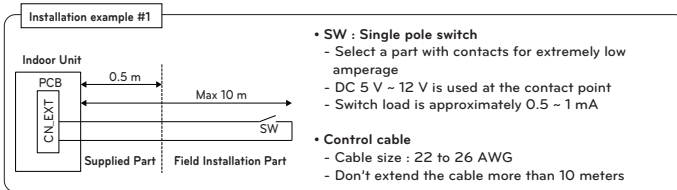
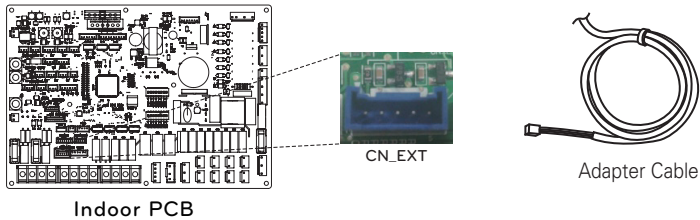

Determining the purpose of CN_EXT
Setting value: 0 ~ 5 step Indoor CN-EXT port setting

- 0: default
- 1: Simple operation on / off
- 2: Dry contact (simple contact)

- 3: Emergency stop only for indoor unit
- 4: Reattachment / absence
- 5: Emergency stop of all indoor units (It can be set only when indoor unit has emergency stop function)

Remote Temperature Sensor

Remote temperature sensor can be installed any place a user wants to detect the temperature.

Installation condition

Role and constraint while installation of remote air temperature sensor is very similar to that of thermostat.

- Distance between the unit and the remote air temperature sensor should be less than 15 m due to length of the connection cable of remote air temperature sensor.
- For other constraints, please refer to previous page where constraints about thermostat is described

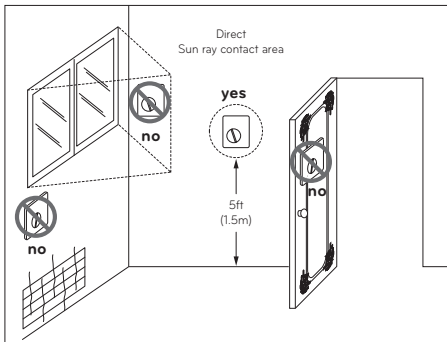

Thermostat

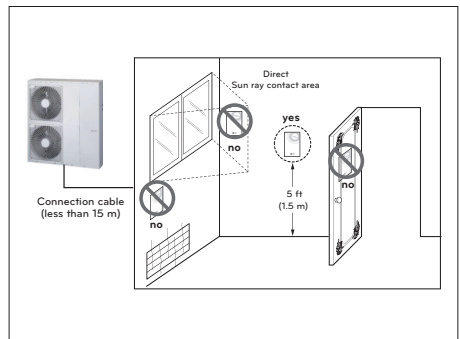

Remote Air Temperature Sensor

How to Install Remote Temperature Sensor

[Parts of Remote Temperature Sensor]



Sensor



Screw(to fix remote sensor)

Follow below procedures step 1 ~ step 5.

Step 1. Decide where the remote temperature sensor is installed. Then, Determine the location and height of the fixing screws in fig. 1 (Interval between the screws : 60 mm)

Step 2. Check if the power of the unit is turned off.

Step 3. Disassemble front panels and distinguish control box(Indoor) of the unit.

Step 4. Insert temperature sensor into PCB(CN_ROOM) and fix the sensor firmly in fig. 2.

Step 5. The Connection wire does not matter if you change the color of the wire because of nonpolar.

- For 3 Series

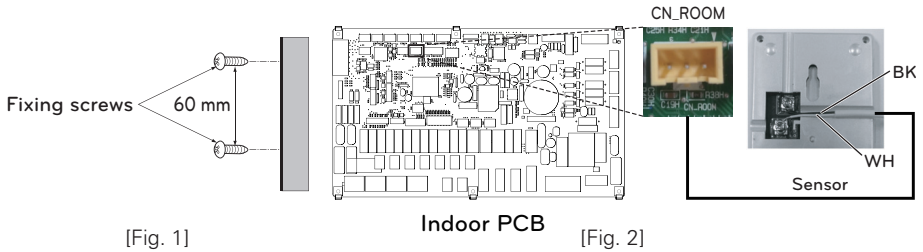

- For 4 Series

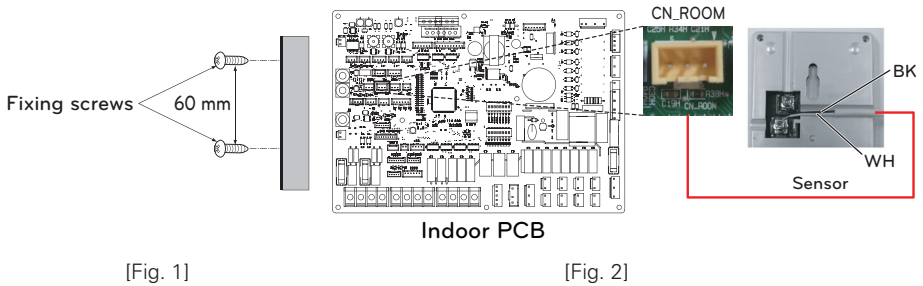

Step 6. Integrate the remote temperature sensor with the screws as the order of arrows.

Fixing the Remote Sensor

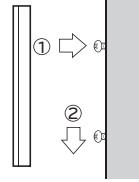

! CAUTION

- Choose the place where the average temperature can be measured for the unit operates.
- Avoid direct sunlight.
- Choose the place where the cooling/heating devices do not affect the remote sensor.
- Choose the place where the outlet of the cooling fan do not affect the remote sensor.
- Choose the place where the remote sensor isn't affected when door is open.

NOTE

- For more information about installing Remote Temperature Sensor, Please refer installation manual provided with Remote Temperature Sensor.
- For more settings about Remote Temperature Sensor, Please refer to 'Select Temperature Sensor / Air cooling set temp. / Air heating set temp. / TH on/off Variable, heating air / TH on/off Variable, cooling air' that 'installer setting' part
- Set DIP switch No. 1 of option switch 3 to 'ON' in order to use remote temperature sensor.(For 3 Series)
- Set DIP switch No. 5 of option switch 2 to 'ON' in order to use remote temperature sensor.(For 4 Series)

Solar pump

Solar pump can be required to energize water flow when solar thermal system is installed.

How to install solar pump

Follow below procedures step 1 ~ step 4.

Step 1. Check if the power of the unit is turned off.

Step 2. Disassemble front panels and distinguish control box(Indoor) of the unit.

Step 3. Check if the harness(Black) is inserted fully to the indoor unit PCB (CN_W_PUMP_B).

Step 4. Connect the external pump to terminal block 1(4/5).

※ It is possible to un-use solar pump depending on installation environment.

- For 3 Series

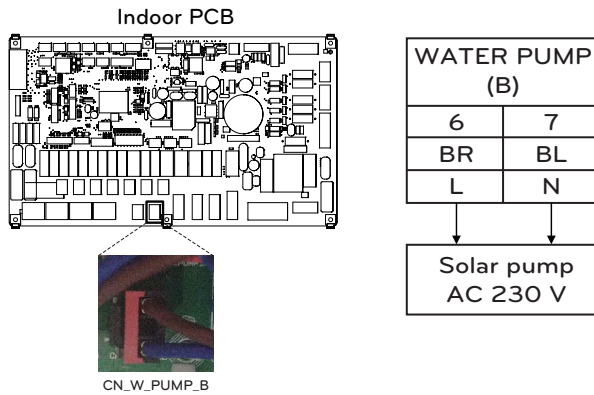

- For 4 Series

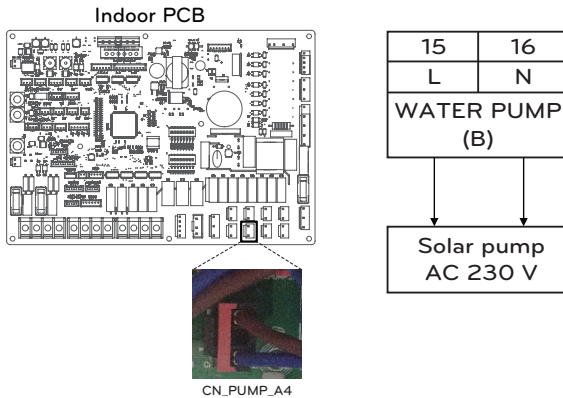

※ The terminal block connection number may differ depending on the model. Refer to the "Wiring Diagram" in the SVC Manual.

⚠ CAUTION

When connecting a pump of 1.05A or higher, its output must be used as a signal line only.

External pump

External pump can be required when the room to take floor heating is too large or not well-insulated.(potential free) Also, External pump is installed with buffer tank to retain sufficient capacity.

How to install external pump

Follow below procedures step 1 ~ step 3.

Step 1. Check if the power of the unit is turned off.

Step 2. Disassemble front panels and distinguish terminal block in Indoor PCB.

Step 3. Connect signal cable to terminal block (TB_W_PUMP_C) fully.

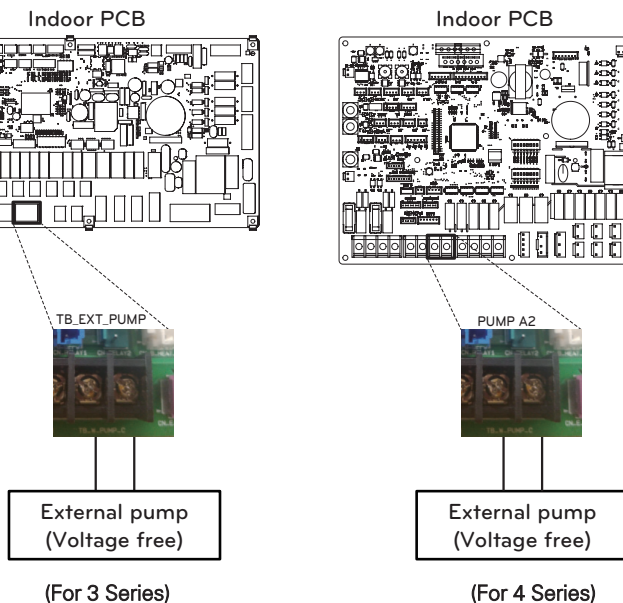

How to install Voltage Free

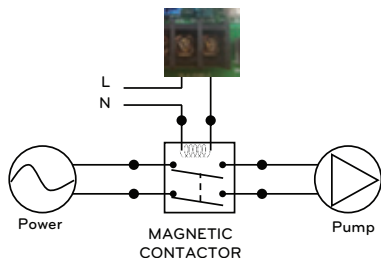

Wi-fi Modem

Wi-fi modem enables remote system operation from smartphone. Available functions include selection of on/off, operation mode, DHW heating, temperature setup and weekly scheduling etc.

How to install Wi-fi Modem

[Parts of Wi-fi modem]



Wi-fi modem body

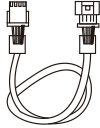

USB Cable

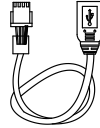

Extension Cable

Follow below procedures step 1 ~ step 5.

Step 1. Check if the power of the unit is turned off.

Step 2. Disassemble front panels and distinguish control box(Indoor) of the unit.

Step 3. Connect the USB cable to the indoor unit PCB (CN_WF ; Blue) until it clicks into place.

Step 4. Connect the Wi-Fi modem to the USB cable fully.

Step 5. Refer to the image below to install the Wi-Fi modem in the marked position.

- For 3 Series

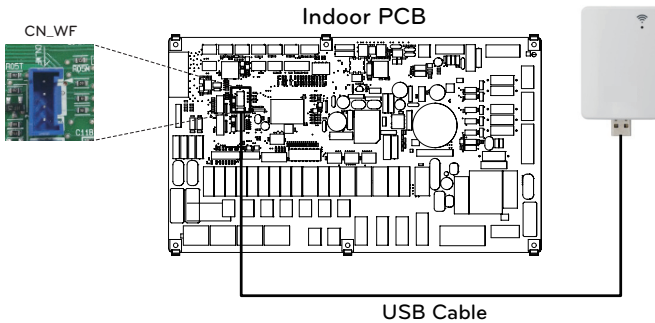

- For 4 Series

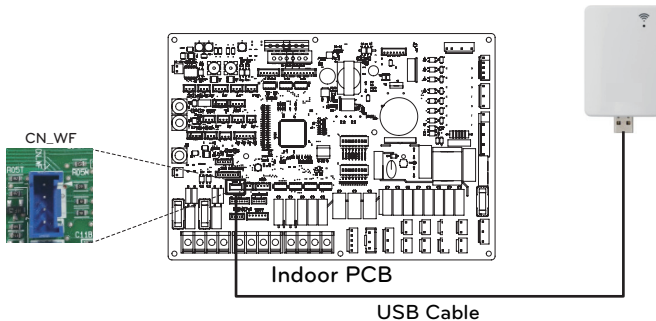

In case of using the extension wire (PWYREW000), fasten the core of extension wire to clamp of the indoor control box.

Energy State

This product provides energy states that enable customers to use as much as possible of their own renewable energy. It can shift setpoints depending on input signal from Energy Storage System (ESS) or from any other third-party device using Modbus RTU or Digital 230V inputs.

Available Energy States

There are 8 energy states available. 4 fixed and 4 customizable - each with the possibility to enhance self consumption of renewable energy.

Energy state	Command	Battery State of charge	Operation (standard setting)					
			Heating		Cooling		Domestic Hot Water	
			Setting	Range	Setting	Range	Setting	Range
1	Operation Off (Utility lock)	Low	Forced internal operation off	Fixed	Forced internal operation off	Fixed	Forced internal operation off	Fixed
2	Normal Operation	Normal	Maintain operation status	Fixed	Maintain operation status	Fixed	Maintain operation status	Fixed
3	Operation On Recommend	High	Increase 2 °C from target temperature	Fixed	Maintain operation Status	Fixed	Increase 5 °C from target temperature	Fixed
4	Operation On Recommend	Very High	Maintain operation status	Fixed	Maintain operation status	Fixed	DHW Target 80 °C	Fixed
5	Operation On Command	Very High	Increase from target temperature	0/+30 (Default : +5)	Decrease from target temperature	0/-30 (Default : -5)	Increase from target temperature	0/+50 (Default : +30)
6	Operation On Recommend	High	Increase from target temperature	0/+30 (Default : +2)	Decrease from target temperature	0/-30 (Default : -2)	Increase from target temperature	0/+50 (Default : +10)
7	Operation Save	Low	Decrease from target temperature	0/-30 (Default : -2)	Increase from target temperature	0/+30 (Default : +2)	Decrease from Target Temperature	0/-50 (Default : 0)
8	Operation Super Save	Very Low	Decrease from target temperature	0/-30 (Default : -5)	Increase from target temperature	0/+30 (Default : +5)	Decrease from Target Temperature	0/-50 (Default : 0)

Digital Input for energy saving (ESS, Smart Grid)

This product provides two digital inputs (TB_SG1 / TB_SG2) that can be used to switch between energy states when not using Modbus RTU (CN-COM).

Available Energy States

There are 8 energy states available in total. Four different states can be triggered using the 230V-inputs – by default Energy states 1-4.

With the digital input assignment in the menu 'Energy state/Digital input assignment of the control panel, different Energy states can be selected for Signals 0:1 and 1:1.

0:0 is always linked with ES2 (Normal operation) and 1:0 is always linked with ES1 (Operation off/Utility lock).

How to set Digital input signal

Follow below procedures step 1 ~ step 3.

Step 1. Check if the power of the unit is turned off.

Step 2. Disassemble front panels and distinguish terminal block in Indoor PCB.

Step 3. Connect signal cable to terminal block in PCB (TB_SG2, TB_SG1) fully as shown below.

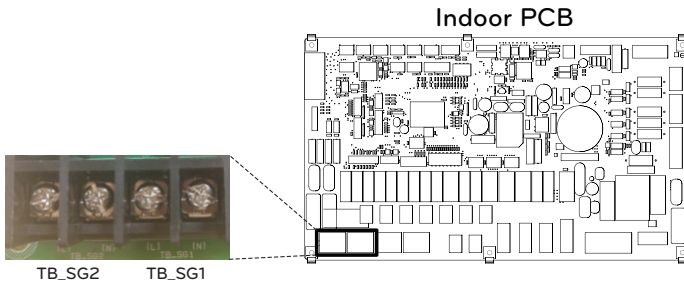

Energy state depending on input signal (TB_SG1/TB_SG2)

Input Signal		Output state	
TB_SG1	TB_SG2	Default	Range
0	0	ES2	fixed
1	0	ES1	
0	1	ES3	ES3-ES8
1	1	ES4	

2Way Valve

2way valve is required to control water flow while cooling operation. Role of 2way valve is to cut off water flow into under floor loop in cooling mode when fan coil unit is equipped for cooling operation.

General Information

THERMAV. supports following 2way valve.

Type	Power	Operating Mode	Supported
NO 2-wire ¹⁾	230 V AC	Closing water flow	Yes
		Opening water flow	
NC 2-wire ²⁾	230 V AC	Closing water flow	Yes
		Opening water flow	

1. Normal Open type. When electric power is NOT supplied, the valve is open. (When electric power is supplied, the valve is closed.)
2. Normal Closed type. When electric power is NOT supplied, the valve is closed. (When electric power is supplied, the valve is open.)

How to Wire 2Way Valve

Follow below procedures Step 1 ~ Step 2.

Step 1. Uncover front cover of the unit.

Step 2. Find terminal block and connect wire as below.

- For 3 Series

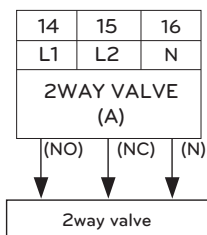

- For 4 Series

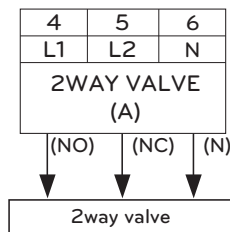

CAUTION

Dew Condensation

- Wrong wiring can yield dew condensation on the floor. If radiator is connected at the under floor water loop, dew condensation can be occurred on the surface of the radiator.

WARNING

Wiring

- Normal Open type should be connected to wire (NO) and wire (N) for valve opening in cooling mode.
- Normal closed type should be connected to wire (NC) and wire (N) for valve closing in cooling mode.

(NO) : Live signal (for Normal Open type) from PCB to 2way valve

(NC) : Live signal (for Normal Closed type) from PCB to 2way valve

(N) : Neutral signal from PCB to 2way valve

※ The terminal block connection number may differ depending on the model. Refer to the “Wiring Diagram” in the SVC Manual.

Final Check

- Flow direction :
 - Water should not flow into under floor loop in cooling mode.
 - To verify the flow direction, check temperature at the water inlet of the under floor loop.
 - If correctly wired, this temperatures should not be approached to 6 °C in cooling mode.

3Way Valve(A)

3Way Valve(A) is required to operate DHW water tank. Role of 3way valve is flow switching between under floor heating loop and water tank heating loop. Plus, it is required to operate 3rd party boiler.

General Information

THERMAV. supports following 3way valve.

Type	Power	Operating Mode	Supported
SPDT ¹⁾ 3-wire	220-240 V~	Selecting Flow A ²⁾ between Flow A and Flow B	Yes
		Selecting Flow B ³⁾ between Flow A and Flow B	Yes

1. SPDT = Single Pole Double Throw. Three wires consist of Live1 (for selecting Flow A), Live 2 (for selecting Flow B), and Neutral (for common).
2. Flow A means 'water flow from the unit to under floor water circuit.'
3. Flow B means 'water flow from the unit to DHW water tank.'

How to wire 3way valve(A)

Follow below procedures Step 1 ~ Step 2.

Step 1. Uncover front cover of the unit.

Step 2. Find terminal block and connect wire as below.

- For 3 Series

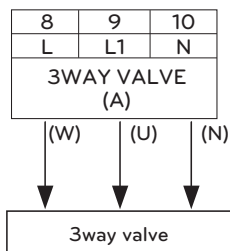

- For 4 Series

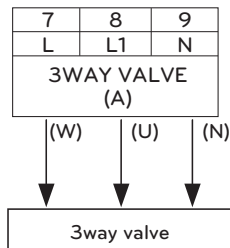

! WARNING

- 3way valve should select water tank loop when electric power is supplied to wire (W) and wire (N).
- 3way valve should select under floor loop when electric power is supplied to wire (U) and wire (N).

(W) : Live signal (Water tank heating) from PCB to 3way valve

(U) : Live signal (Under floor heating) from PCB to 3way valve

(N) : Neutral signal from PCB to 3way valve

※ The terminal block connection number may differ depending on the model. Refer to the "Wiring Diagram" in the SVC Manual.

3Way Valve(B)

3way valve(B) is required to operate Solar thermal system. Role of 3way valve is flow switching between open and close mode of the solar circuit.

General Information

THERMA V. supports following 3way valve.

Type	Power	Operating Mode	Supported
SPDT ¹⁾ 3-wire	220-240 V~	Selecting Flow A ²⁾ between Flow A and Flow B	Yes
		Selecting Flow B ³⁾ between Flow A and Flow B	Yes

1. SPDT = Single Pole Double Throw. Three wires consist of Live1 (for selecting Flow A), Live 2(for selecting Flow B), and Neutral (for common).
2. Flow B means 'heat source toward solar panel repeatedly'. (close mode of circuit)
3. Flow A means 'heat source flow from solar panel to DHW tank in solar circuit'. (open mode of circuit)

How to wire 3way valve(B)

Follow below procedures Step 1 ~ Step 2.

Step 1. Uncover front cover of the unit.

Step 2. Find terminal block and connect wire as below.

- For 3 Series

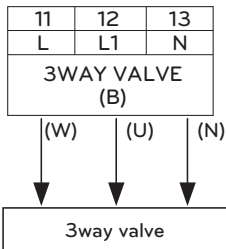

- For 4 Series

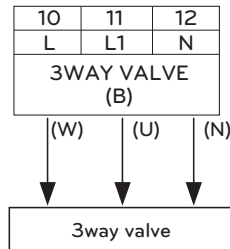

! WARNING

- 3way valve should select "close solar circuit" when electric power is supplied to wire (W) and wire (N).
- 3way valve should select "open solar circuit" when electric power is supplied to wire (U) and wire (N).

(W) : Live signal (close solar circuit) from PCB to 3way valve

(U) : Live signal (open solar circuit) from PCB to 3way valve

(N) : Neutral signal from PCB to 3way valve

* The terminal block connection number may differ depending on the model. Refer to the "Wiring Diagram" in the SVC Manual.

Electric Heater

How to Pipe Electric Heater

Follow below procedures Step 1 ~ Step 4.

Step 1. Uncover the electric heater accessory.

Step 2. Check the diameter of pre-installed pipes of unit.

Step 3. If the diameter of pre-installed pipes is different from diameter of electric heater accessory kit, it is necessary to reduce or expand pipe's diameter.

Step 4. Connect the pipes. The inlet pipe of electric heater accessory must be connected to outlet of the unit.

WARNING

Followings should be kept before installation

- The unit should be stop before the piping work.
- Never connect electric power while piping electric heater.
- Before the piping working, water in the part(or to heating loop) installed with electric heater should be drained. After working, water should be charged.

CAUTION

- Electric Heater should be installed with enough space for installation and service.
- Water pipes and connections should be cleaned using water.
- Methods to prevent leakage in plumbing connections must be applied.
- Heater must not be impacted.
- Do not let dirty particle be dropped inside tank to avoid possibility of degrade.
- After installation, make it sure that no leakage is appeared in the connection.

Terminal Block Information

Symbols used below pictures are as follows :

- L, L1, L2 : Live (220-240 V~)
- N : Neutral (220-240 V~)
- R, S, T : Live (380-415 V 3N~)
- BR : Brown, WH : White, BL : Blue, BK : Black

<1Ø 3 kW>

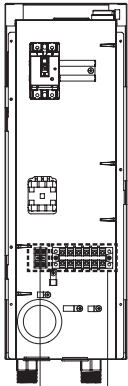

Terminal Block 1
Terminal Block 2

<1Ø 6 kW>

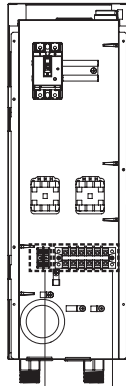

Terminal Block 1
Terminal Block 2

<3Ø 6 kW>

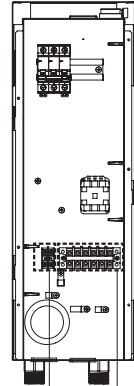

Terminal Block 1
Terminal Block 2

How to Wire Electric Heater

- For 3 Series

Follow below procedures Step 1 ~ Step 4.

Step 1. Uncover the electric heater accessory.

Step 2. Find the terminal block and connect wires. Refer to the installation manual of the electric heater. (Wires are field-supplied item.)

Step 3. Connect terminal block ports unit and electric heater accessory.

- 1Ø 3kW, 3Ø 6kW = single capacity

- 1Ø 6kW = 2Step control is possible through Heater(A)/Heater(B).

(1Ø 3 kW) Terminal Block 2 (In Backup Heater)

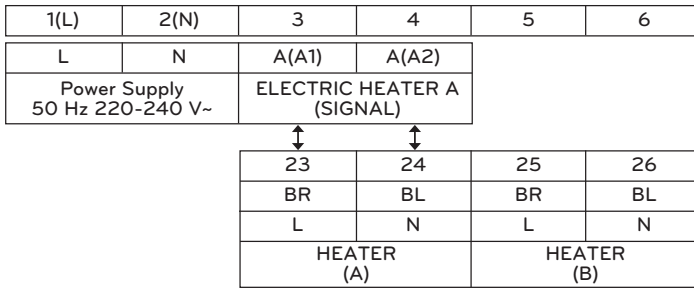

Terminal Block 3 (In Unit)

(1Ø 6 kW) Terminal Block 2 (In Backup Heater)

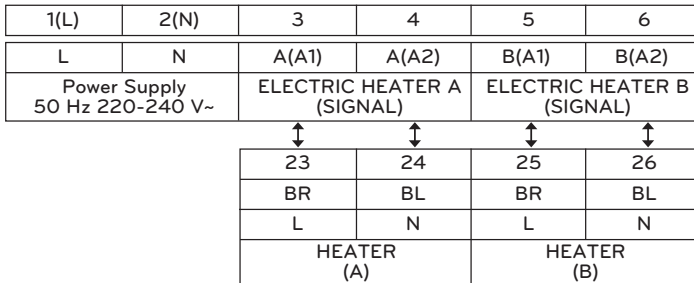

Terminal Block 3 (In Unit)

(3Ø 6 kW) Terminal Block 2 (In Backup Heater)

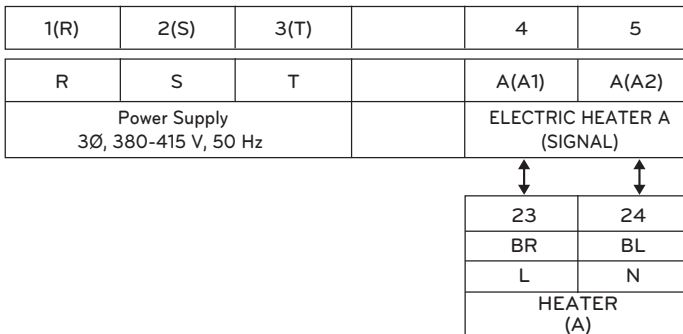

Terminal Block 3 (In Unit)

Step 4. Connect power supply cable to terminal block 2.

When Tightening the power cable on terminal block, Be careful to prevent a shock or injury.

Terminal Block 2 (In 1Ø Backup Heater)

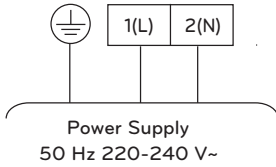

Terminal Block 2 (In 3Ø Backup Heater)

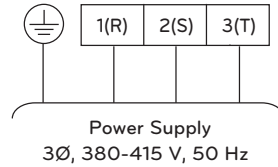

- For more information about installing Electric Heater, Please refer installation Manual provided with Electric Heater

* The terminal block connection number may differ depending on the model. Refer to the "Wiring Diagram" in the SVC Manual.

- For 4 Series

Follow below procedures Step 1 ~ Step 4.

Step 1. Uncover the electric heater accessory.

Step 2. Find the terminal block and connect wires. (Wires are field-supplied item.)

Step 3. Connect terminal block ports of unit and electric heater accessory.

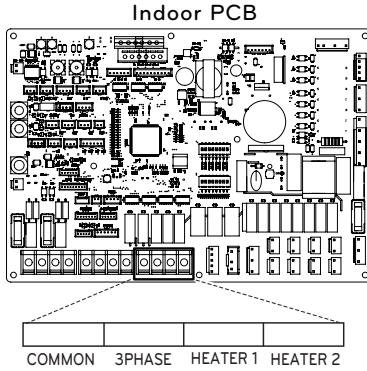

(1Ø 3 kW) Terminal Block 2 (In Backup Heater)

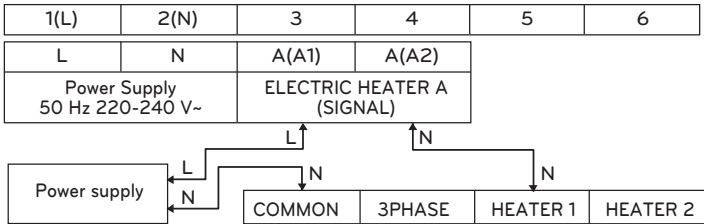

(1Ø 6 kW) Terminal Block 2 (In Backup Heater)

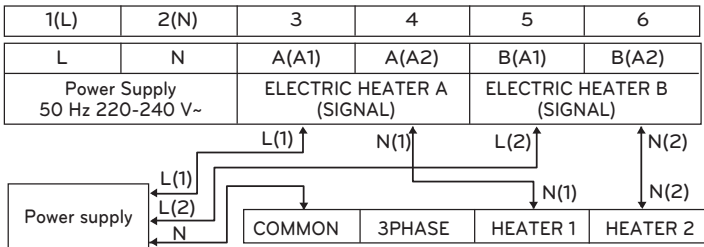

(3Ø 6 kW) Terminal Block 2 (In Backup Heater)

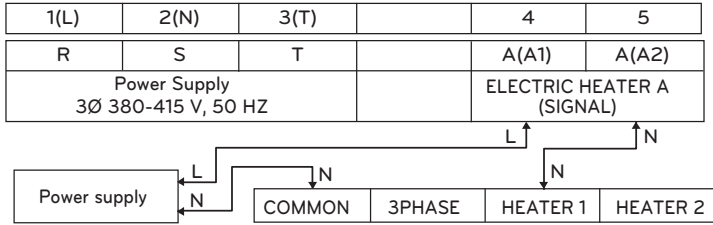

Step 4. Connect power supply cable to terminal block 2.

Terminal Block 2 (In 1Ø Backup Heater)

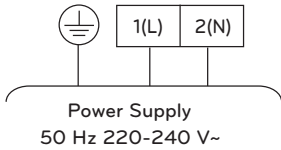

Terminal Block 2 (In 3Ø Backup Heater)

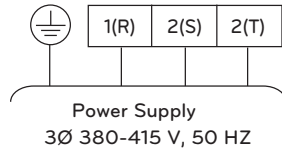

NOTE

Turn off electric power supply before setting DIP switch.
Whenever adjusting DIP switch, turn off electric power supply to avoid electric shock.

Description	Setting	Default
Selecting electric heater capacity	 6 7	Electric heater is not used
	 6 7	Half capacity is used only for HA061M
	 6 7	Full capacity is used
		 6 7

* For the above change, you need to adjust 6 and 7 of Indoor PCB option switch2.

Typical Installation Example (Backup heater for Monobloc)

Floor heating + Backup Heater (Only Heating)

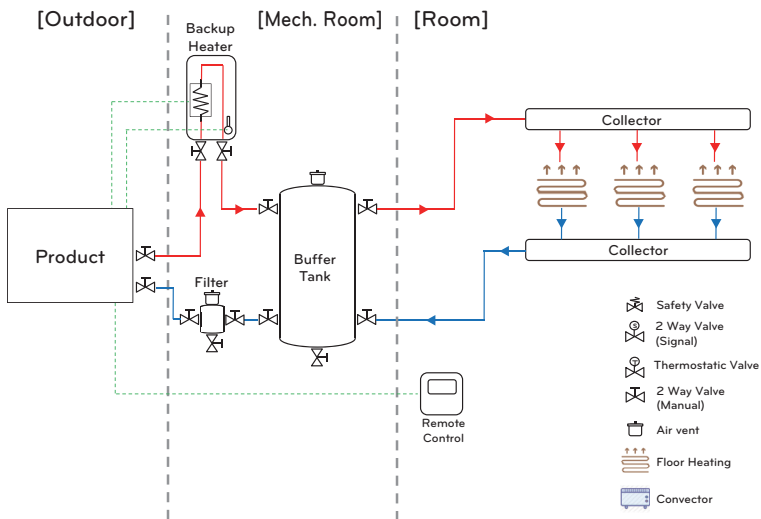

Floor heating + Convactor + Backup Heater (Heating + Cooling)

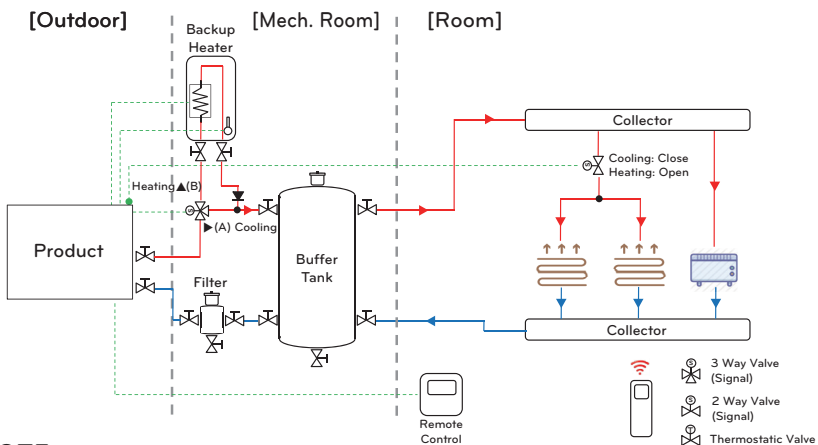

NOTE

- When the Backup Heater is installed in a reversible system, condensation may occur inside the Backup Heater.
- To provide a bypass for the condensate, install 3way valve.
- During cooling operation, connect the 3-Way Valve using the 2-Way Valve connection terminal to prevent water from going to the Backup Heater

3 Way Valve direction
 Flow A (Bypass) : Cooling
 Flow B (Heater) : Heating

How to Install 3way Valve for Backup Heater Bypass

Follow below procedures Step 1 ~ Step 2.

Step 1. Uncover front cover of the unit.

Step 2. Find terminal block and connect wire as below.

When Tightening the connect wire on terminal block, Be careful to prevent a shock or injury. (230 VAC)

- For 3 Series

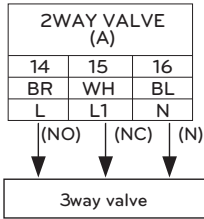

! WARNING

- When type of 2way valve is NO type, 3way valve should select Flow A(bypass). Electric power is supplied to wire(NO) and wire(N).
- When type of 2way valve is NC type, 3way valve should select Flow B(heating In Backup heater). Electric power is supplied to wire(NC) and wire(N).

- For 4 Series

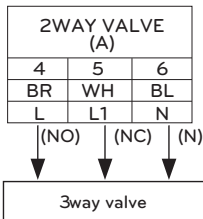

! CAUTION

- 3way valve should be connected together with 2way valve in terminal block.
- Keep the distance between 3way valve and Backup Heater more than 0.5m.
- To prevent reverse flow, It is important to use one way valve(check valve) to Backup Heater water outlet.

How to Connect Backup Heater Sensor to Unit

Follow below procedures Step 1 – Step 5.

- ① Find backup heater terminal block Kit(Fig. 1).
- ② Assemble the terminal block kit using screw on unit.
- ③ Plug it to 'E/Heater Out' (White Connector) of CN_TH3 in the Main PCB (Unit) as shown Fig.2.
- ④ Connect harness between the unit and the Backup Heater until it clicks into place.(Fig. 3).
- ⑤ Use the cord clamp to fix the cable through low voltage hole.

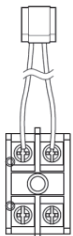

Fig.1

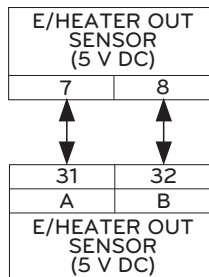

Fig.2



Fig.3

* The terminal block connection number may differ depending on the model. Refer to the "Wiring Diagram" in the SVC Manual.

Final check

No.	Check point	Description
1	Connection of Water Inlet/Outlet	<ul style="list-style-type: none"> - Check if the shut-off valves should be assembled with Water inlet and outlet pipe of the unit - Check the location of the water inlet/outlet water pipe
2	Hydraulic pressure	<ul style="list-style-type: none"> - Check the pressure of supplying water by using pressure gage inside the unit - Pressure of Supplying water should be Under 3.0 bar approximately
3	Water pump capacity	<ul style="list-style-type: none"> - To secure enough water flow rate, do not set water pump capacity as Minimum. - It can lead unexpected flow rate error CH14. (Refer to 'Water Piping and Water Circuit Connection')
4	Transmission line and power source wiring	<ul style="list-style-type: none"> - Check if Transmission line and power source wiring are separated from each other. - If it is not, electronic noise may occur from the power source.
5	The power cord specifications	<ul style="list-style-type: none"> - Check the power cord specifications (Refer to 'Connecting Cables')
6	3Way Valve	<ul style="list-style-type: none"> - Water should flow from Water outlet of the unit to DHW tank Water inlet when DHW tank heating is selected. - To verify the flow direction, Make sure that the water outlet temperature of the unit and water inlet temperature of DHW Water tank are similar
7	2Way Valve	<ul style="list-style-type: none"> - Water should not flow into under floor loop in cooling mode. - To verify the flow direction, check temperature at the water inlet of the under floor loop. - If correctly wired, this temperatures should not be approached to 6 °C in cooling mode.
8	Air Vent	<ul style="list-style-type: none"> - Air-vent must be located highest level of Water pipe system - It should be installed at the point which is easy to service. - It takes some times to remove air in the water system if air purge is not performed sufficiently it may occur CH14 error. (Refer to 'Water Charging')

CONFIGURATION

As **THERMAV** is designed to satisfy various installation environment, it is important to set up system correctly. If not configured correctly, improper operation or degrade of performance can be expected.

- For 3 Series

DIP Switch Setting

⚠ CAUTION

Turn off electric power supply before setting DIP switch





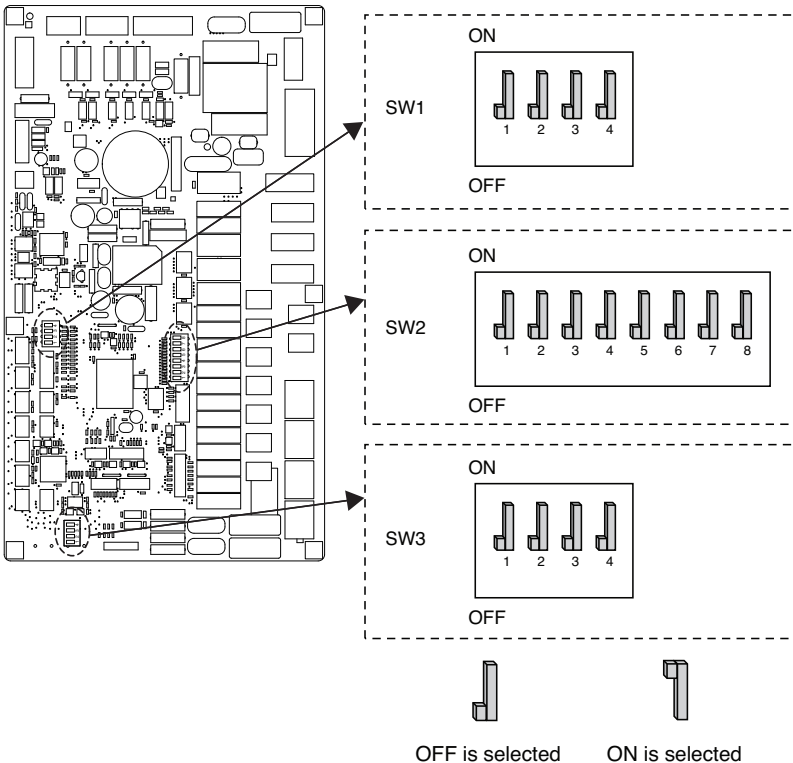









- Whenever adjusting DIP switch, turn off electric power supply to avoid electric shock.

Indoor PCB







DIP Switch Information







Option Switch 2

Description	Setting		Default
Accessory installation information		Unit + Outdoor unit is installed	
		Unit + Outdoor unit + DHW tank is installed	
		Unit + Outdoor unit + DHW tank + Solar thermal system is installed	
Cycle	4 	Heating Only	
	4 	Heating & Cooling	
Selecting electric heater capacity		Electric heater is not used	
		Half capacity is used only for HA061M	
		Full capacity is used	
Thermostat installation information	8 	Thermostat is NOT installed	
	8 	Thermostat is installed	

Option Switch 1

Description	Setting		Default
MODBUS	1 	As Master	
	1 	As Slave	
MODBUS Function	2 	Common 3 rd party	

Option Switch 3

Description	Setting		Default
Remote Air Sensor	1 	Remote sensor is not installed	1 
	1 	Remote sensor is installed	
ANTIFREEZE	2 	Antifreezing solution not using mode	2 
	2 	Antifreezing solution using mode	



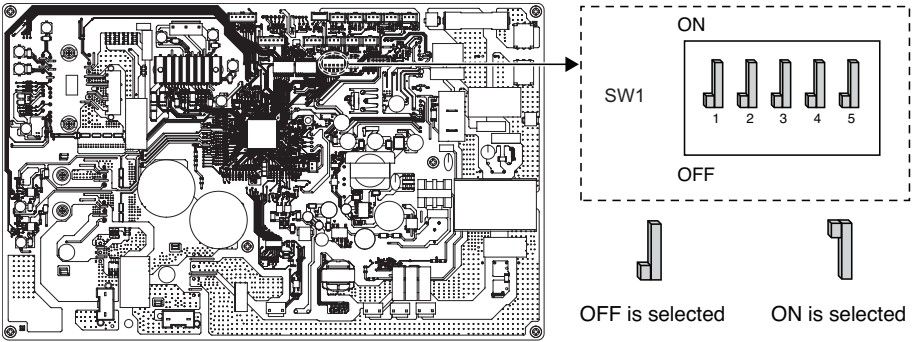



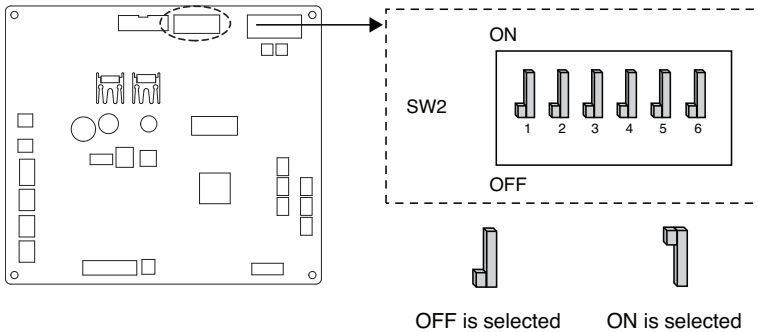



Outdoor PCB (5, 7, 9 kW)



Outdoor PCB (12, 14, 16 kW)



DIP Switch Information

Description	Setting		Default
Low Noise Mode	2 	Normal Low Noise Mode	2 
	2 	Limited Low Noise Mode	
Peak Control	3  4 	Max Mode	3  4 
	3  4 	Peak Control Step 1 - To limit maximum current (Power saving)	
	3  4 	Peak Control Step 2 - To limit maximum current (Power saving)	

- * Only DIP Switch no. 2 and no.3 has a function. Others have no function.
- * When setting the limited low noise mode, Mode can be exited to secure capacity after operating for a certain time.

NOTE

* Input current value can be limited by DIP Switch operation.

Model Name			Peak Control Mode Running Current (A)	
Chassis	Phase (Ø)	Capacity (kW)	1 Step	2 Step
UN36A	1	5	13	
		7	14	
		9	15	
UN60A	1	9	15	
		12	23	20
		14	24	21
	3	16	25	22
		12	8	6
		14	9	7
		16	10	8

- For 4 Series

DIP Switch Setting

! CAUTION





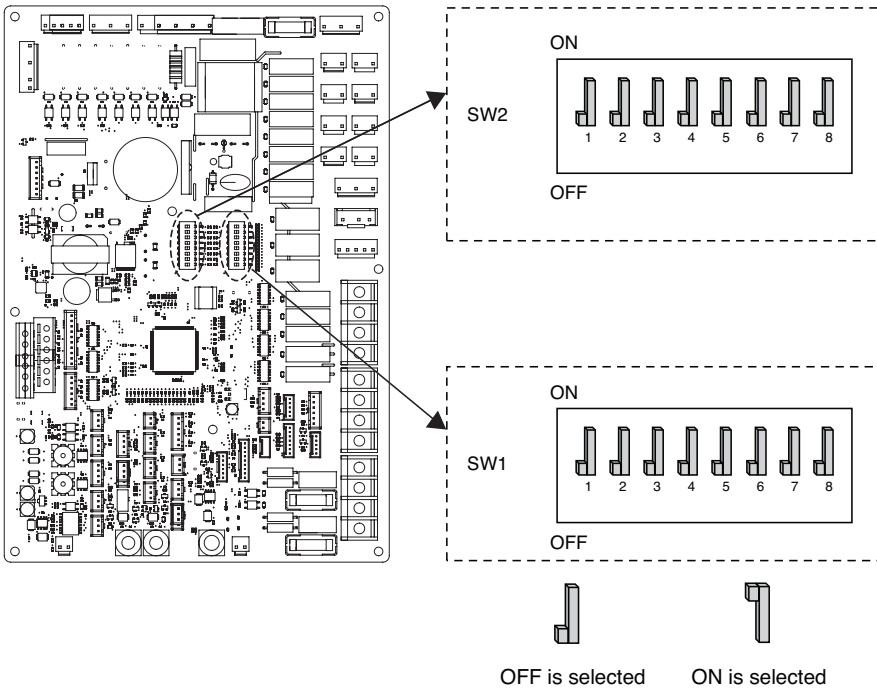











- Turn off electric power supply before setting DIP switch
- Whenever adjusting DIP switch, turn off electric power supply to avoid electric shock.

Indoor PCB











DIP Switch Information

Option Switch 2

Description	Setting		Default
Accessory installation information	 2 3	Heat pump is installed (Heating(Cooling) circuit only)	
	 2 3	Heat pump + DHW tank is installed	
	 2 3	Heat pump + DHW tank + Solar thermal system is installed	
Cycle	4 	Heating Only	4 
	4 	Heating & Cooling	
Room Air Sensor	5 	Room Air Sensor is not installed	5 
	5 	Room Air Sensor is installed	
Selecting electric heater capacity	 6 7	Electric heater is not used	
	 6 7	Half capacity is used only for HA061M	
	 6 7	Full capacity is used	
Thermostat installation information	8 	Thermostat is NOT installed	8 
	8 	Thermostat is installed	

Option Switch 1

Description	Setting		Default
MODBUS Communication Type	1 	As Master (LG extension modules)	1 
	1 	As Slave (3rd party controller)	
MODBUS Function	2 	Unified Open Protocol	2 
Antifreeze Agent	8 	Antifreeze agent is not used	8 
	8 	Antifreeze agent is used *	

* Possibility to allow colder water temperature by setting.
 Bridge at CN_ANTI_SW must be dis-connected to enable setting.



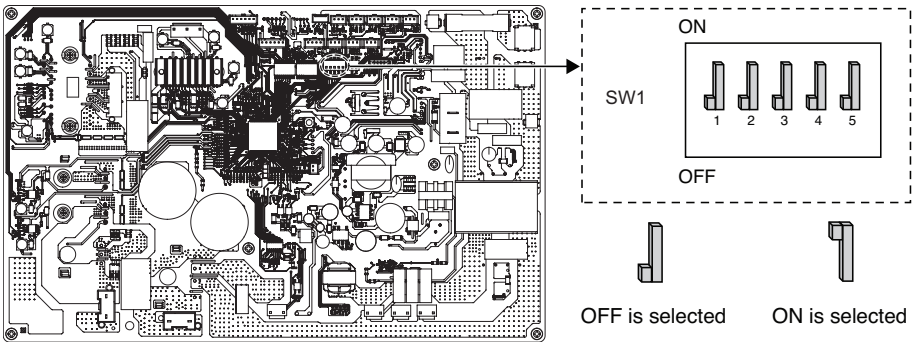



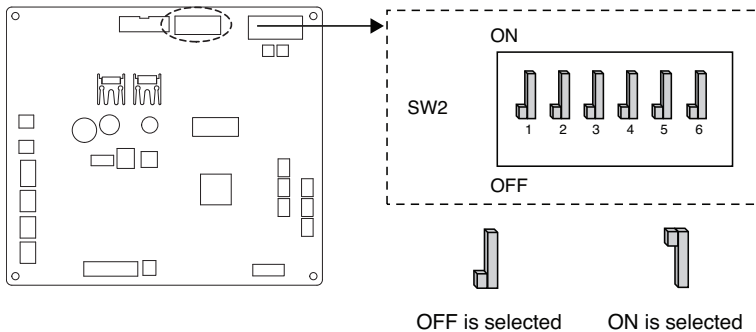









Outdoor PCB (1Ø : 5, 7, 9 kW)



Outdoor PCB (3Ø : 9 kW / 1Ø, 3Ø : 12, 14, 16 kW)



DIP Switch Information

Description	Setting		Default
Low Noise Mode	2 	Normal Low Noise Mode	2 
	2 	Limited Low Noise Mode	
Peak Control	3  4 	Max Mode	3  4 
	3  4 	Peak Control Step 1 - To limit maximum current (Power saving)	
	3  4 	Peak Control Step 2 - To limit maximum current (Power saving)	
Defrost Mode	2  5 	Normal Defrost Mode - The same mode as the existing defrost logic	2 
	2  5 	Rapid Defrost Mode - Rapid defrost mode in adverse defrost conditions	5 

* Only DIP Switch no. 2 and no.3 has a function. Others have no function.

* When setting the limited low noise mode, Mode can be exited to secure capacity after operating for a certain time.

NOTE

* Input current value can be limited by DIP Switch operation.

Model Name		Peak Control Mode Running Current (A)		
Chassis	Phase (Ø)	Capacity (kW)	1 Step	2 Step
UN36A	1	5	13	
		7	14	
		9	15	
	3	9	8	6
UN60A	1	12	23	20
		14	24	21
		16	25	22
	3	12	8	6
		14	9	7
		16	10	8

NOTE**Emergency Operation****• Definition of terms**

- Trouble : a problem which can stop system operation, and can be resumed temporarily under limited operation without certificated professional's assist.
- Error : problem which can stop system operation, and can be resumed only after certificated professional's check.
- Emergency mode : temporary heating operation while system met Trouble.

• Objective of introducing 'Trouble'

- Not like air conditioning product, Air-to-Water heat pump is generally operation in whole winter season without any system stopping.
- If system found some problem, which is not critical to system operating for yielding heating energy, the system can temporarily continue in emergency mode operation with end user's decision.

• Classified Trouble

- Trouble is classified two levels according to the seriousness of the problem : Slight Trouble and Heavy trouble
- Slight Trouble : a problem is found inside the unit. In most case, this trouble is concerned with sensor problems. The outdoor unit is operating under emergency mode operation condition which is configured by DIP switch No. 4 of the unit PCB.
- Heavy trouble : a problem is found inside the outdoor unit. As the outdoor unit has problem, the emergency mode operation is performed by electric heater located in the unit.
- Option Trouble : a problem is found for option operation such as water tank heating. In this trouble, the troubled option is assumed as if it is not installed at the system.

• When the AWHP has any trouble,

(1) If there is not a function to judge possibility of operation :

Once a trouble occurs mainly in indoor unit, AWHP stops. On the other hand, Remocon allows the product to activate On/ Off operation.(On : emergency operation)

- Slight / Heavy trouble : Heating Operable only
- Critical trouble : Full stop
- Treatment priority : Critical>Heavy>Slight

(2) If there is a function to judge possibility of operation :

Depending on the status of slight / heavy / critical trouble, pop-up phrase is guided separately on display.

- Slight trouble : Heating/Cooling Operable
- Heavy trouble : Heating Operable only
- Critical trouble : Service center request

AWHP operates when user pressed OK button on pop-up window.

NOTE**• Duplicated trouble : Option trouble with slight or heavy trouble**

- If option trouble is occurred with slight (or heavy) trouble at the same time, the system puts higher priority to slight (or heavy) trouble and operates as if slight (or heavy) trouble is occurred.

- Therefore, sometimes DHW heating can be impossible in emergency operation mode. When DHW is not warming up while emergency operation, please check if DHW sensor and related wiring are all OK.

• Emergency operation is not automatically restarted after main electricity power is reset.

- In normal condition, the product operating information is restored and automatically restarted after main electricity power is reset.

- But in emergency operation, automatic re-start is prohibited to protect the product.

- Therefore, user must restart the product after power reset when emergency operation has been running.

SERVICE SETTING

How to enter service setting

To enter the menu displayed at the bottom, you need to enter the service setting menu as follows.

- In the menu screen, press [←,→(left/right)] button to select the setting category, and press [OK] button to move to the setting list.
- In the setting list, select the service setting category, and press [OK] button to move to the service setting list.

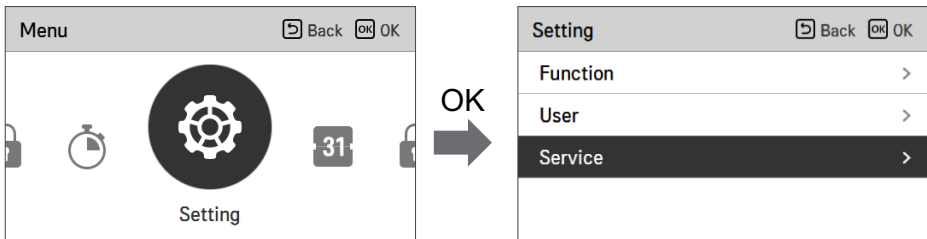

Service setting

- You can set the product service functions.
- Some functions may not be displayed/operated in some product types.

Menu	Description
Service contact	Check and input the service center phone number that you can call when there is service issue.
Model information	View product and capacity information
RMC Version Information	Check the remote controller model name and software version.
Open Source License	View the remote controller's open source license.

Service Contact

Check and input the service center phone number that you can call when there is service issue.

- In the service setting list, select the service contact point and press [OK] button to move to the detail screen.
- While “edit” button is selected, press [OK] button to move to the edit screen, change it, and press [OK] button to change the service contact point.

Service	Back	OK
Service Contact	>	
Model Information	>	
RMC Version Information	>	
Open Source License	>	



OK

Service Contact	Back	OK
Telephone +1544-7777		
Edit		



OK

Service Contact	Back	OK
Telephone		
+ 1 5 4 4 - 7 7		
7 7		

Model Information

Check product and capacity information to which the remote controller is connected.

- In the service setting list, select model information category, and press [OK] button to move to the detail screen.
- The unit capacity
 - $1 \text{ kWh} = 1 \text{ kBtu} * 0.29307$
 - kWh is the result calculated based on Btu, There may be a small difference between calculated and actual capacity.
 - Ex) If the unit capacity is 18 kBtu, it is displayed as 5 kWh.

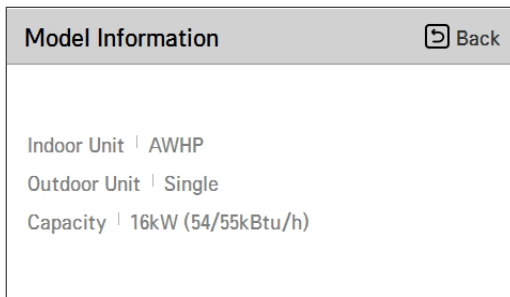
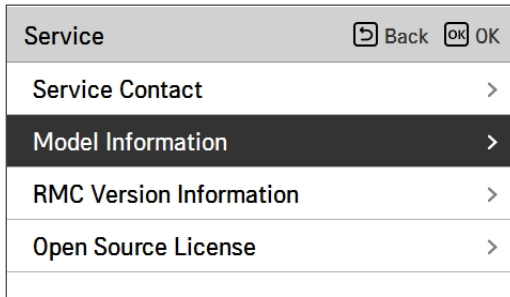

RMC Version Information

View the remote controller software version.

- In the service setting list, select the RMC version information and press [OK] button to move to the detail screen

Service	Back	OK
Service Contact	>	
Model Information	>	
RMC Version Information	>	
Open Source License	>	



RMC Version Information	Back
SW Version 3.03.1a	

Open Source License

View the remote controller's open source license.

- In the service setting list, select the open source license category, and press [OK] button to move to the detail screen.

Service	⏪ Back	OK
Service Contact		>
Model Information		>
RMC Version Information		>
Open Source License		>



Open Source License		⏪ Back
LGE Open Source Software Notice		
Product Type	HVAC WIRED REMOTE CONTR	
Model Number/Range	RS3 Wired Remote Controller	1/401
Those products identified by the Product Type and Model Range above from LG Electronics, Inc. ("LGE") contain the open source software detailed below. Please refer to the		

INSTALLER SETTING (For 3 Series)

How to enter installer setting

CAUTION

The installer setting mode is the mode to set the remote controller's detail function. If the installer setting mode is incorrectly set, it may cause product failure, user's injury, or property damage. It must be set by the installation specialist with the installation license, and if it is installed or changed without installation license, all problems caused will be the responsibility of the installer, and may void the LG warranty.

- In the menu screen, press [,<,>(left/right)] button to select the setting category, and press [^ (up)] button for 3 seconds to enter the password input screen for the installer setting.
- Input the password and press [OK] button to move to the installer setting list.

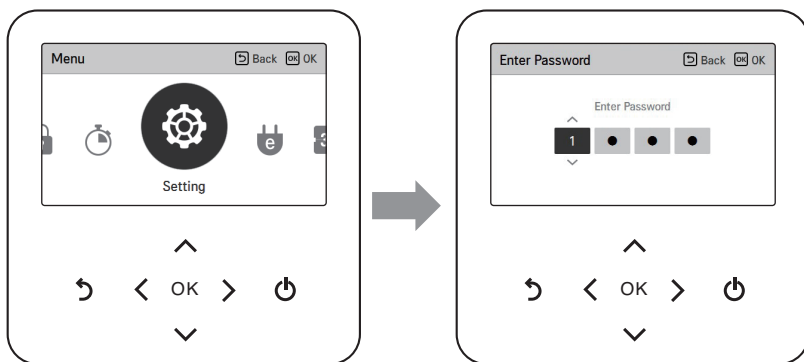

※ Installer setting password

Main screen → menu → setting → service → RMC version information → SW Version

Example) SW version : 1.00.1 a

In the above case, the password is 1001.

NOTE

Some categories of the installer setting menu may not be available depending on the product function or the menu name may be different.

Installer setting (For 3 Series)

- You can set the product user functions.
- Some functions may not be displayed/operated in some product types.

Function	Description
3 Minutes Delay	Factory use only
Select Temperature Sensor	Selection for setting temperature as air temperature or leaving water temperature or air+leaving water temperature
Dry Contact Mode	Dry contact function is the function that can be used only when the dry contact devices is separately purchased and installed.
Central Control address	When connecting the central control, set the central control address of the unit.
Pump Test run	Water pump test run
Air cooling set temp.	Adjusting range of 'Setting Air Temperature' in cooling mode
Water cooling set temp.	Adjusting range of 'Setting Leaving Water Temperature' in cooling mode
Air heating set temp.	Adjusting range of 'Setting Air Temperature' in heating mode
Water heating set temp.	Adjusting range of 'Setting Heating Flow Temperature' in heating mode
DHW Set Temp.	Setting DHW set temperature
Screed drying	Setting for using Step 1 or 2 capacity of electric
Heater on temperature	Setting outdoor air temperature where half capacity of electric heater starts operation.
Water supply off temp. during cooling	Determine leaving water temperature when the unit is turned off. This function is used for preventing condensation on the floor in cooling mode
Tank disinfection setting 1, 2	Setting start/maintain time for pasteurisation Setting pasteurisation temperature
Tank setting 1	Setting start temperature for operation
Tank setting 2	Setting maintain temperature for operation
Heater priority	Determine electric heater and water heater on and off
DHW time setting	Determine follow time duration : operation time of domestic hot water tank heating, stop time of domestic hot water tank heating, and delay time of DHW tank heater operating
TH on/off Variable, heating air	Heating air temperature TH On / Off Type setting
TH on/off Variable, heating Water	Heating Water Outlet Temperature TH On / Off Type

Function	Description
TH on/off Variable, cooling air	Cooling air temperature TH On / Off Type setting
TH on/off Variable, cooling Water	Cooling Water Outlet Temperature TH On / Off Type
Heating temp. setting	At the leaving water control in heating mode, the control reference water temperature position setting
Cooling temp. setting	At the leaving water control in cooling mode, the control reference water temperature position setting
Pump setting in heating	Set water pump on / off delay option in heating mode
Pump setting in cooling	Set water pump on / off delay option in cooling mode
Forced operation	Water pump off After 20 consecutive hours, disable / enable the logic that drives the water pump by itself
CN_CC	It is the function to set whether to install (use) Dry Contact. (It is not a function for Dry Contact installation, but it is a function to set the usage of the unit's CN_CC port.)
Pump Capacity	Function to change Water Pump Capacity
Seasonal auto temp	Set the operating temperature in Seasonal Auto mode
Modbus Address	It is function to set the address of the Modbus device that is externally linked to the product. Modbus address setting function is available from indoor unit.
CN_EXT	Function to set external input and output control according to DI / DO set by customer using dry contact port of indoor unit. Determine the use of the contact port (CN_EXT) mounted on the indoor unit PCB
Anti-freezing Temperature	This function prevents the product from freezing.
Add Zone	Install additional valve in product to control additional operation area
Use External Pump	Set up to control an external water pump
3rd Party Boiler	Configuration to control 3rd party boiler
Meter Interface	When installing the meter interface to measure energy / calorie in the product, set unit spec for each port
Pump Prerun/Overrun	Set to reach the optimum flow rate by circulating the heating water with the water pump before heat exchange. After the operation stop, additional water pump is activated to circulate the heating water.
Solar Thermal System	Function to set operation reference value in Solar Thermal System.
Energy state	This function is to control the product according to the energy state. ESS USE TYPE can be selected and product operation can be changed according to energy state.
Data logging	Display error history of connected unit
Password Initialization	It is the function to initialize (0000) the password when you forgot the password set in the remote controller.

3 Minutes Delay

Temporarily eliminates the 3-minute delay function of the outdoor unit Comp

- Factory use only

- In the installer setting list, select 3 Minutes Delay category, and press [OK] button to move to the detail screen.

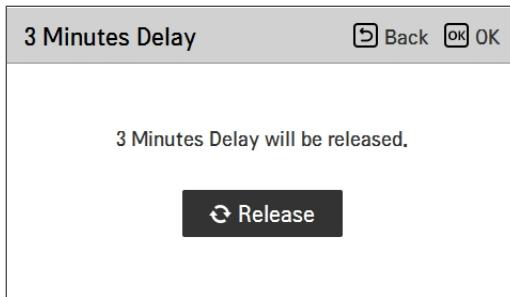
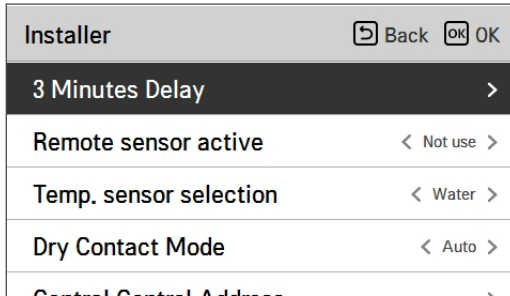

Select Temperature Sensor

The product can be operated according to air temperature or leaving water temperature. The selection for setting temperature as air temperature or leaving water temperature is determined.

- In the installer setting list, Select Temperature Sensor category, and press [OK] button to move to the detail screen.

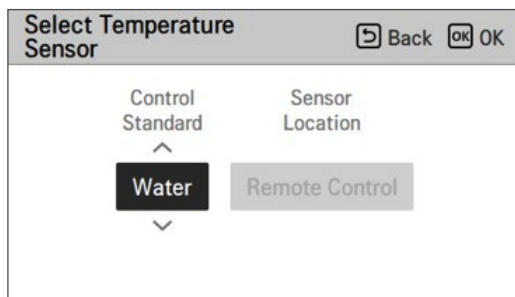
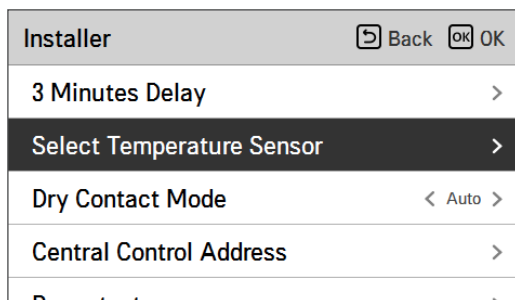

Value	Default	Range
Control Standard	Water	Water / Air / Air + Water
Sensor Location	Remote Control	Remote Control / Indoor Unit

* When Water is selected, Sensor Location is disabled.

NOTE

- When the sensor location is set to indoor unit, Remote Air Sensor Connection and the change of DIP switch setting (No. 1 of Option Switch 3) are required
- When the sensor location is set to Remote Control, the RS3 controller must be placed inside of suitable Reference room.

Dry Contact Mode

Dry contact function is the function that can be used only when the dry contact devices is separately purchased and installed.

- Change setting values using [<,>(left/right)] button.

Installer		Back	OK
3 Minutes Delay	>		
Remote sensor active	< Not use >		
Temp. sensor selection	< Water >		
Dry Contact Mode	< Auto >		
Control Control Address	>		

Value
Auto
manual

NOTE

For dry contact mode related detail functions, refer to the individual dry contact manual.

What is dry contact?

It means the contact point signal input when the hotel card key, human body detection sensor, etc. are interfacing with the air conditioner.

Added system functionality by using external inputs (dry contacts and wet contacts).

Central Control Address

When connecting the central control, set the central control address of the unit.

- In the installer setting list, select Central Control Address category, and press [OK] button to move to the detail screen.

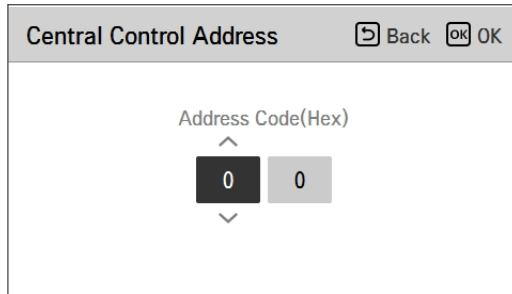
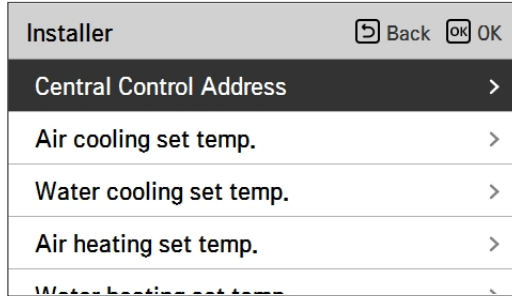

NOTE

- Enter address code as hexadecimal value
- Front: Central Control Gr. No.
- Back side: Central control indoor the number

Pump test run

The pump test run is the function to test run by operating the water pump. This function can be used for air vents / flow sensors and others.

- In the installer setting list, Pump Test run category, and press [OK] button to move to the detail screen.

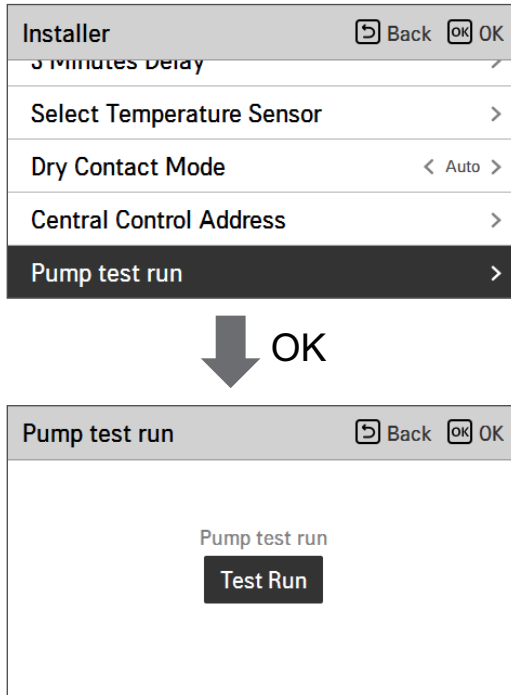

NOTE

The setting for thermostat and dry contact should be disabled to use the Pump test run function.

Air cooling set temp.

Determine cooling setting temperature range when air temperature is selected as setting temperature.

- In the installer setting list, select Air cooling set temp category, and press [OK] button to move to the detail screen.

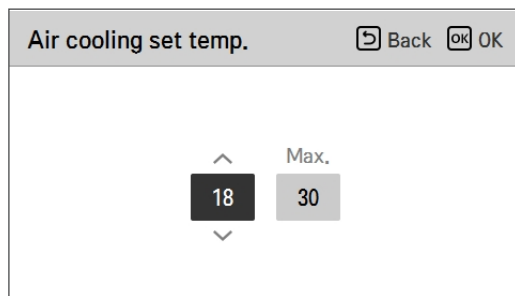
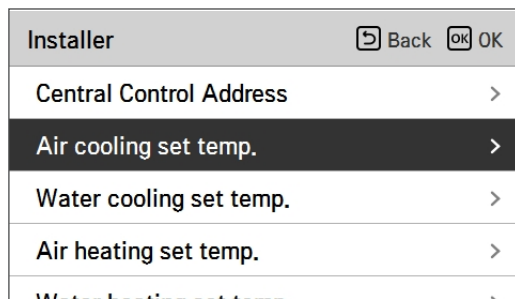

Value	Default	Range
Min.	18 °C	16 ~ 22 °C
Max.	30 °C	24 ~ 30 °C

NOTE

It is possible to control the unit based on room air temperature by using either remote air temperature sensor or wired remote controller (RS3).

- Remote room air sensor is an accessory (PQRSTA0) and sold separately.
- DIP switch setting (No. 1 of Indoor unit Option Switch 3) and installer setting (Select Temperature Sensor) should be set properly in order to use remote room air temperature sensor (PQRSTA0).

Water cooling set temp.

Determine cooling setting temperature range when leaving water temperature is selected as setting temperature.

- In the installer setting list, select water cooling set temp category, and press [OK] button to move to the detail screen.

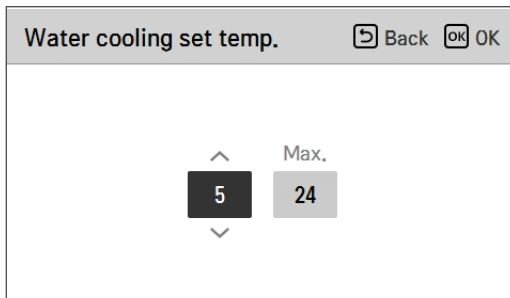
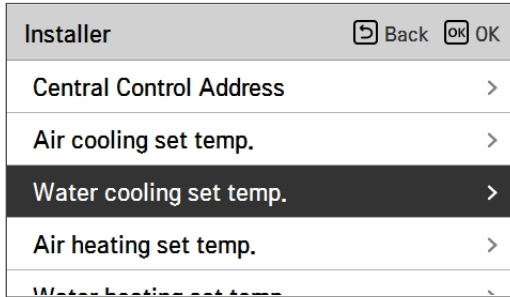

Value	Default	Range
Min.	18 °C	5 ~ 20 °C
Max.	24 °C	22 ~ 27 °C

NOTE

Water condensation on the floor

- While cooling operation, it is very important to keep leaving water temperature higher than 16 °C. Otherwise, dew condensation can be occurred on the floor.
- If floor is in humid environment, do not set leaving water temperature below 18 °C.

Water condensation on the radiator

- While cooling operation, cold water may not flow to the radiator. If cold water enters to the radiator, dew generation on the surface of the radiator can be occurred.

Air heating set temp.

Determine heating setting temperature range when air temperature is selected as setting temperature

- In the installer setting list, select Air heating set temp. category, and press [OK] button to move to the detail screen.

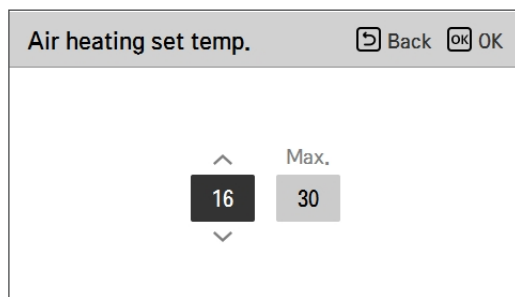
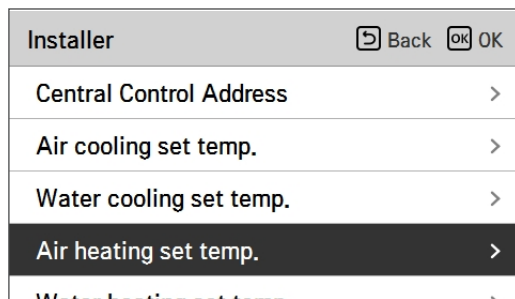

Value	Default	Range
Min.	16 °C	16 ~ 22 °C
Max.	30 °C	24 ~ 30 °C

NOTE

It is possible to control the unit based on room air temperature by using either remote air temperature sensor or wired remote controller (RS3).

- Remote room air sensor is an accessory (PQRSTA0) and sold separately.
- DIP switch setting (No. 1 of Indoor unit Option Switch 3) and installer setting (Select Temperature Sensor) should be set properly in order to use remote room air temperature sensor (PQRSTA0).

Water heating set temp.

Determine heating setting temperature range when leaving water temperature is selected as setting temperature

- In the installer setting list, select Water heating set temp. category, and press [OK] button to move to the detail screen.

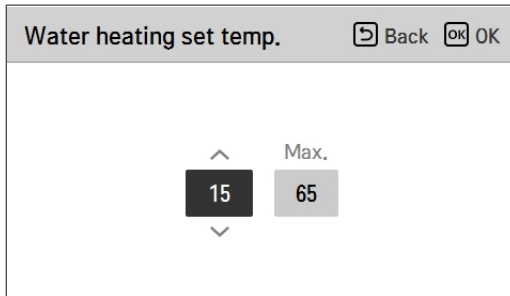
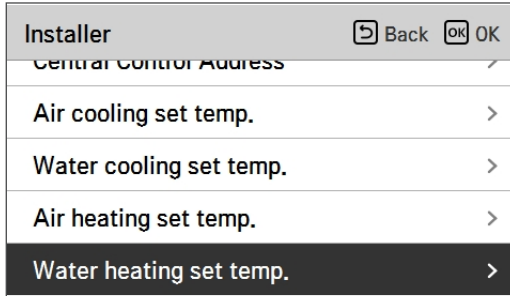

Value	Default	Range
Min.	15 °C	15 ~ 34 °C
Max.	65 °C	35 ~ 65 °C

NOTE

- When the backup heater is not used, the minimum temperature of the water temperature can be set in the range of 34 °C to 20 °C. (Default : 20 °C)

DHW set temp.

Determine heating setting temperature range when DHW temperature is selected as setting temperature

- In the installer setting list, select DHW set temp. category, and press [OK] button to move to the detail screen.

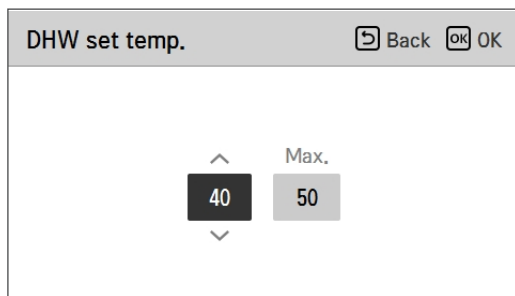
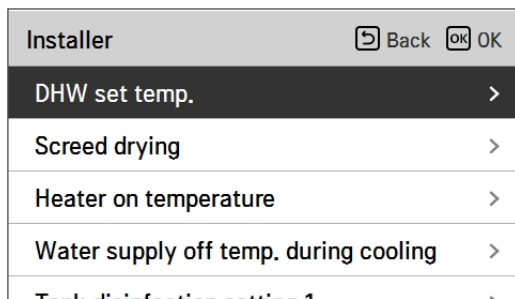

Value	Default	Range
Min.	40 °C	30 ~ 40 °C
Max.	50 °C	50 ~ 80 °C

NOTE

When DHW tank heater(booster heater) is in 'not used' status, Max. temperature will be limited.

Screed drying

This function is a unique feature of AWHP that, when AWHP is installed in a new concrete structure, controls the specific temperature floor heating out temperature for a certain period of time to cure the floor cement.

- In the installer setting list, select Screed drying category, and press [OK] button to move to the detail screen.

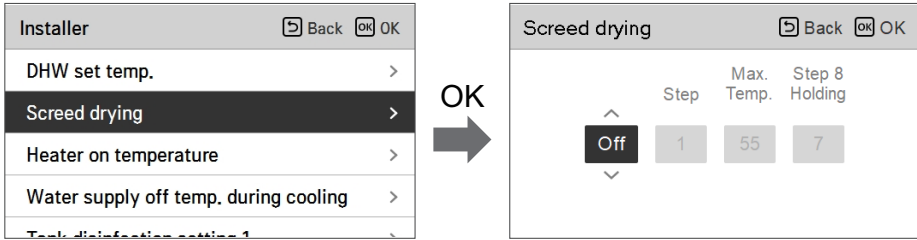

How to display

Main Screen - Displays 'Screed drying' on the desired temperature display. The step in progress at the bottom of the display is displayed.

Setting value

- Start-up step: 1 ~ 11
- Maximum temperature : 35 °C ~ 55 °C
- Step 8 Holding time : 1 days ~ 30 days

Function operation

- It is performed by the following procedure from the selected starting step.
- After all steps are completed, turn off the cement curing operation.

Value	Step										
	1	2	3	4	5	6	7	8	9	10	11
LWT	25 °C	Max. T	Off	25 °C	35 °C	45 °C	Max. T	Max. T	45 °C	35 °C	25 °C
Duration	72 h	96 h	72 h	24 h	24 h	24h	24 h	Holding time	72 h	72 h	72 h

* LWT: Leaving Water Target Temp.

* Holding time range : 1 ~ 30 day(default: 7 day)

- ※ If the upper limit setting value of the heating LW temperature is 55 °C or lower, it is set to 55 °C forcibly.
If the lower limit setting value of the heating LW temperature is 25 °C or higher, it is set to 25 °C forcibly.

NOTE

- During Screed drying operation, button input except for installer function and temperature display is restricted.
- When the power is applied again after a power outage during product operation, the product operation state before power failure is remembered and the product is automatically operated.
- Screed drying operation stops when an error occurs / When error is cleared, restart cement Screed drying. (However, if the wired remote control is reset to the error occurrence state, it is compensated in the unit of one day)
- Upon releasing after an error, Screed drying operation may take up to 1 minute of waiting time after boot up. (The Screed drying operation status is judged as 1 minute cycle.)
- During Screed drying operation, installer function Screed drying operation is selectable.
- During Screed drying operation, starting operation, low noise mode off, low noise time setting off, hot water off, solar heat off.
- During Screed drying operation, simple, sleep, on, off, weekly, holiday, heater does not execute reservation operation.

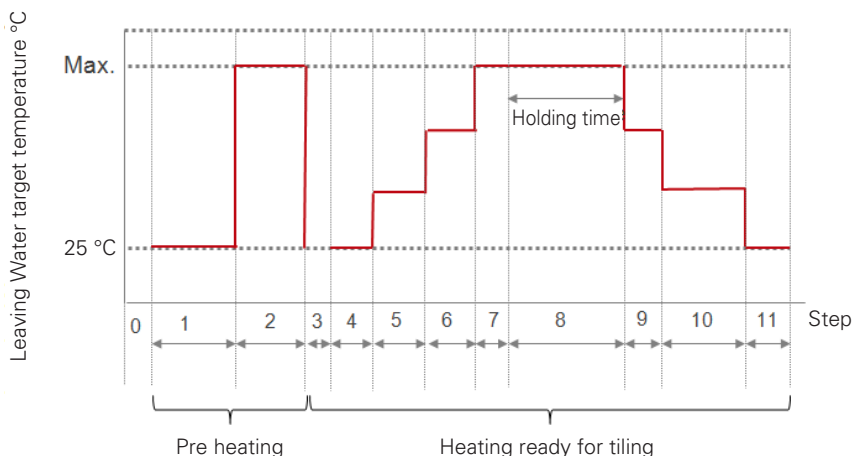

Heater on temperature

Depending on local climatic conditions, it is necessary to change the temperature condition in which electric heater turns on / off.

- In the installer setting list, Heater on temperature category, and press [OK] button to move to the detail screen.

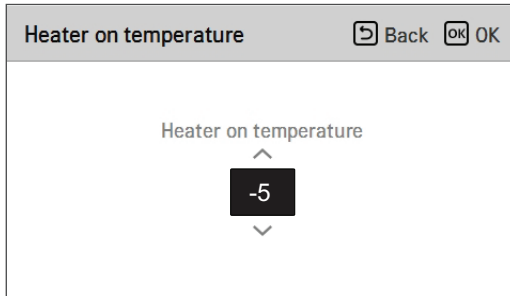
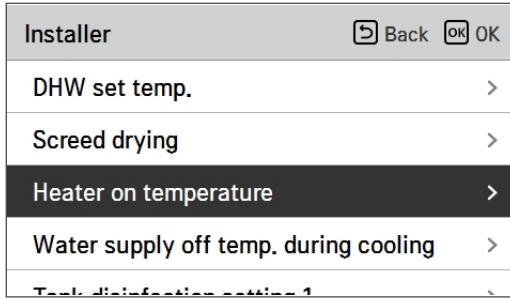

Value	Default	Range
Heater on temperature	-5 °C	-25 ~ 18 °C

NOTE**Heater on temperature**

- Using Half capacity of electric heater

When DIP Switch No. 6 and 7 is set as 'OFF-ON' :

Example : If Heater on temperature is set as '-1' and DIP switch No 6. and 7 is set as 'OFF-ON', then half capacity of electric heater will start operation when outdoor air temperature is below -1 °C and current leaving water temperature or room air temperature is much below than target leaving water temperature or target room air temperature.

- Using Full capacity of electric heater

When DIP Switch No. 6 and 7 is set as 'OFF-OFF' :

Example : If Heater on temperature is set as '-1' and DIP switch No 6. and 7 is set as 'OFF-OFF', then full capacity of electric heater will start operation when outdoor air temperature is below -1 °C and current leaving water temperature or room air temperature is much below than target leaving water temperature or target room air temperature.

Water supply off temp. during cooling

Determine leaving water temperature when the unit is turned off. This function is used for preventing condensation on the floor in cooling mode

- In the installer setting list, select Water supply off temp. during cooling category, and press [OK] button to move to the detail screen.

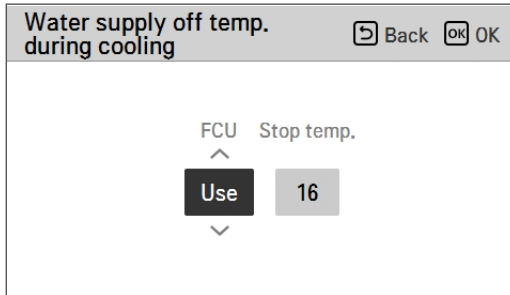
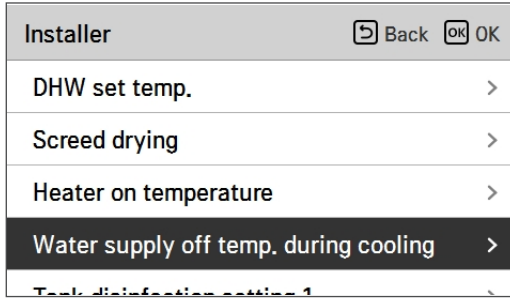

Value	Default	Range
FCU	Use	Use / Not Use
Stop temp.	16 °C	FCU Use: 5 ~ 25 °C FCU Not Use: 16 ~ 25 °C

- Stop temp. : cut-off temp. Stop temp. is valid when FCU is set as 'Use'.
- FCU : determines if FCU is installed or not.
- Example : If Stop temp. is set as '10' and FCU is 'Use' and actually FCU is NOT installed in the water loop, the unit stop operation in cooling mode when the leaving water temperature is below 10 °C.
- Example : If Stop temp. is set as '10' and FCU is 'Not use' and actually FCU is installed in the water loop, the Stop temp. is not used and the unit do NOT stop operation in cooling mode when the leaving water temperature is below 10 °C.

CAUTION

FCU Installation

- If FCU is used, related 2way valve should be installed and connected to the unit PCB.
- If FCU is set as 'Not use' but FCU or 2way valve is NOT installed, the unit can do abnormal operation.

Tank disinfection setting 1, 2

- Disinfection operation is special DHW tank operation mode to kill and to prevent growth of legionella inside the tank.
 - Disinfection active : Selecting enable or disable of disinfection operation.
 - Start date : Determining the date when the disinfection mode is running.
 - Start time : Determining the time when the disinfection mode is running.
 - Max temp. : Target temperature of disinfection mode.
 - Duration time : Duration of disinfection mode.

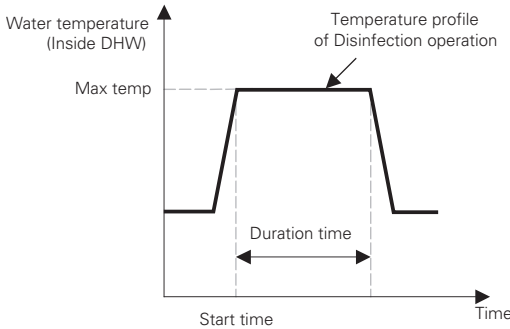

Installer [Back] [OK]

- Tank disinfection setting 1 >
- Tank disinfection setting 2 >
- Tank setting1 >
- Tank setting2 >
- Water priority >



Tank disinfection setting 1 [Back] [OK]

Disinfection active	Start date	Start time
Not use	Fri.	23

Installer [Back] [OK]

- Tank disinfection setting 1 >
- Tank disinfection setting 2 >
- Tank setting1 >
- Tank setting2 >
- Water priority >



Tank disinfection setting 2 [Back] [OK]

Max temp.	Duration time
70	10

NOTE

DHW heating should be enable

- If Disinfection active is set as 'Not use', that is 'disable disinfection mode', Start date and Start time is not used.

Tank setting1

- In the installer setting list, select tank setting 1 category, and press [OK] button to move to the detail screen.

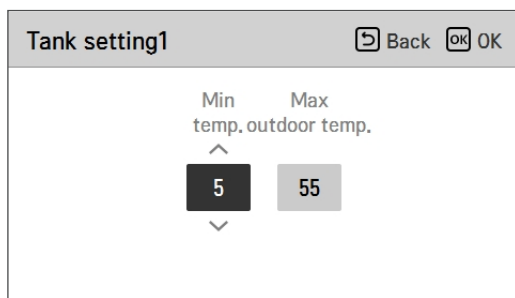
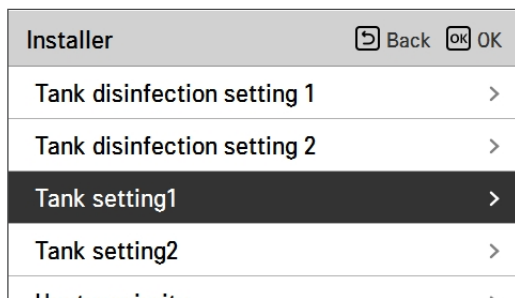

Value	Default	Range
Min Temp.	5 °C	1 ~ 30 °C
Max outdoor temp.	55 °C	40 ~ 58 °C

NOTE

"Max outdoor temp." means rising Max temp. by heat pump cycle.
Above this temp., only electric heater will be used.

Tank setting2

- In the installer setting list, select tank setting 2 category, and press [OK] button to move to the detail screen.

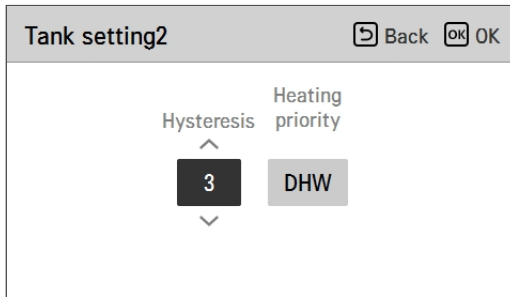
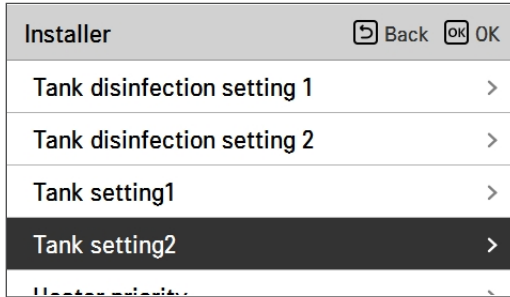

Value	Default	Range
Hysteresis	3 °C	2 ~ 4 °C
Heating priority	DHW	Floor heating / DHW

• Tank setting 1, 2

Descriptions for each parameters are as following.

- Min temp. : temperature gap from Max outdoor temp.
- Max outdoor temp. : maximum temperature generated by AWHP compressor cycle.
- Example : If Min temp. is set as '5' and Max outdoor temp. is set as '48', then Session A (see the graph) will be started when the water tank temperature is below 43 °C.... If temperature is above 48 °C..., then Session B will be started.
- Hysteresis : Temperature gap from target DHW temperature for booster heater operating. This value is required to prevent frequent On and Off of water tank heater. In the normal DHW operation, the value is set as '0' and Hysteresis is valid when heater delay time is active.
- Example : If user's target temperature is set as '70' and Hysteresis is set as '3', then the booster heater will be turned off when the water temperature is above 73 °C. The booster heater will be turned on when the water temperature is below 70 °C.
- Heating priority : Determining heating demand priority between DHW tank heating and under floor heating.
- Example : If Heating priority is set as 'DHW', that means heating priority is on DHW heating, DHW is heated by AWHP compressor cycle and booster heater. In this case the under floor can not be heated while DHW heating. On the other hand, if the Heating priority is set as 'Floor heating', that means heating priority is on under floor heating, DHW tank is ONLY heated by booster heater. In this case the under floor heating is not stopped while DHW is heated.

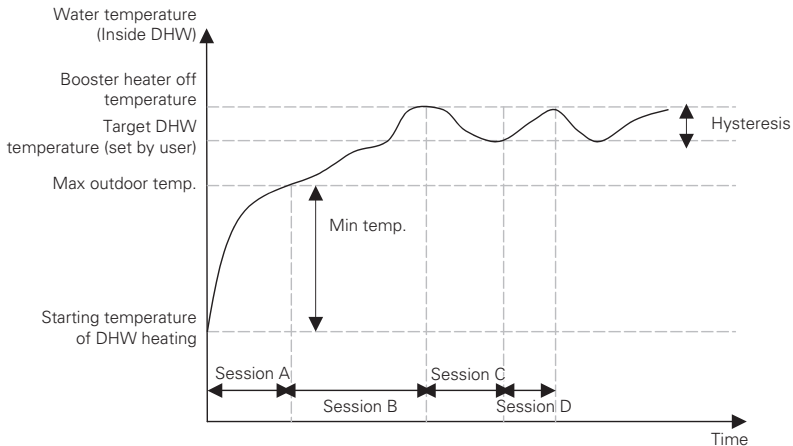

Session A : Heating by AWHP compressor cycle and booster heater

Session B : Heating by booster heater

Session C : No heating (booster heater is Off)

Session D : Heating by booster heater

NOTE

DHW heating does not operate when it is disabled.

Heater priority

- Heater priority: It is decided whether to use the boost heater for DHW operation and the backup heater for floor heating at the same time by condition.
- Example: If the heater priority is set to 'Main+Boost heater ON', the backup heater and boost heater are turned on/off according to the control logic. (It can be turned on at the same time) If Heater Priority is set to 'Boost heater only ON', the backup heater does not operate when the boost heater operates according to the control logic. (When the boost heater is not in operation, the backup heater operates according to the logic.)
- In the installer setting list, heater priority category, and press [OK] button to move to the detail screen.

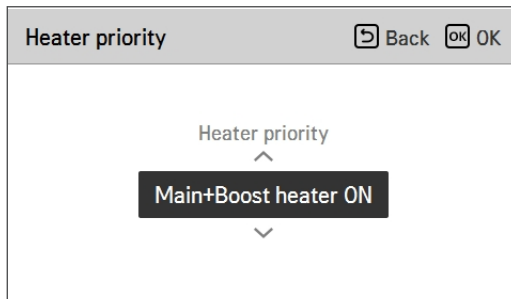
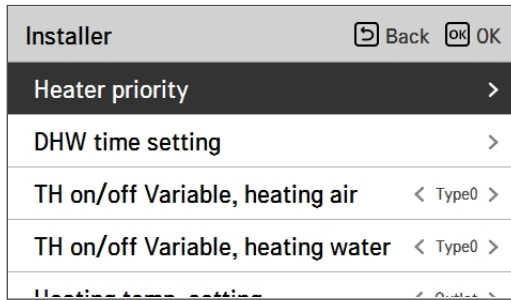

Value	
Boost heater only ON	Main+Boost heater ON

DHW time setting

Determine following time duration : operation time of DHW tank heating, stop time of DHW tank heating, and delay time of DHW tank heater operating.

- Active time : This time duration defines how long time DHW tank heating can be continued.
- Stop time : This time duration defines how long time DHW tank heating can be stopped. It is also regarded as time gap between DHW tank heating cycle.
- Boost heater delay time : This time duration defines how long time DHW tank heater will not be turned on in DHW heating operation.
- Example of timing chart :

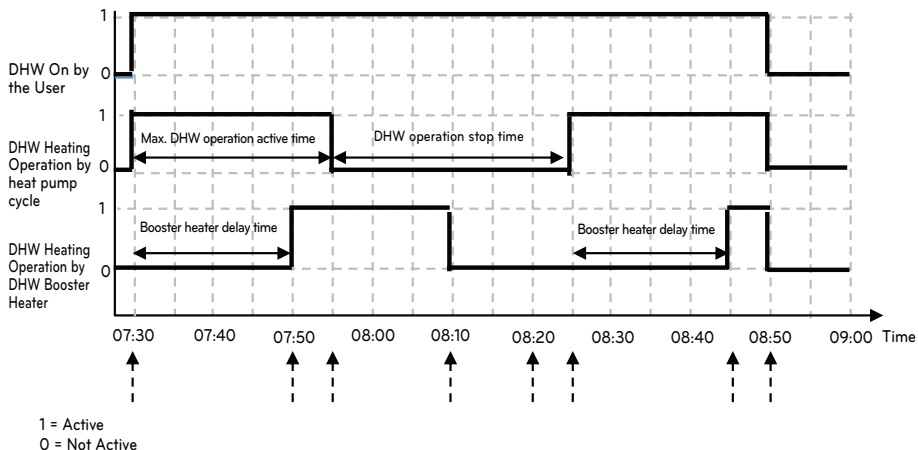

Time	Description
7:30	The user activates the DHW function in the remote controller (DHW operation starts by the heat pump cycle as the Thermo on condition is reached)
7:50	The booster heater is activated after the booster heater delay time(20 min)
7:55	The active time(25min) of DHW operation by the heat pump cycle ends and the heat pump cycle is forced to be stopped (The booster heater is continues to operate because the target temperature is not reached)
8:10	The booster heater operation ends as the target temperature is reached
8:20	DHW operation is not activated by the stop time(30 min) even though the water temperature is dropped and DHW operation condition is reached.
8:25	When the active time condition is reached, DHW operation starts again by the heat pump cycle
8:45	The booster heater is activated after the booster heater delay time(20 min)
8:50	The user deactivates the DHW function by turning it off in the remote controller

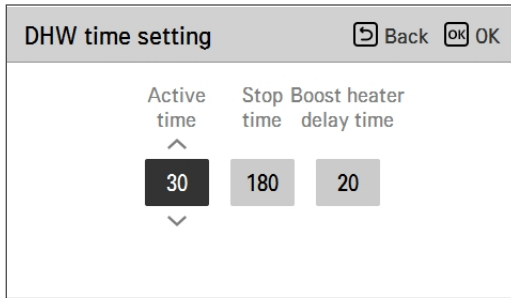
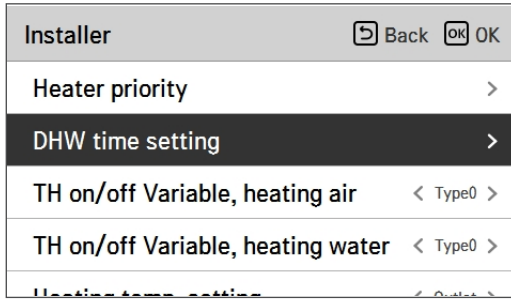

Value	Default	Range
Active time	30 min	5~95 min
Stop time	180 min	0~600 min
Boost heater delay time	20 min	20~95 min

TH on/off Variable, heating air

It is a function to adjust the heating air temperature Thermal On / Off temperature according to the field environment in preparation for heating or heating claim.

- You can set the following setting values using [\leftarrow , \rightarrow](left/right) button.

Installer		Back	OK
Heater priority			>
DHW time setting			>
TH on/off Variable, heating air	< Type0 >		
TH on/off Variable, heating water	< Type0 >		
Heating temp. setting	< 20.0 >		

Value	Description	
	TH On	TH Off
Type0	-0.5 °C	1.5 °C
Type1	-1 °C	2 °C
Type2	-2 °C	3 °C
Type3	-3 °C	4 °C

- Example : Type0 setting

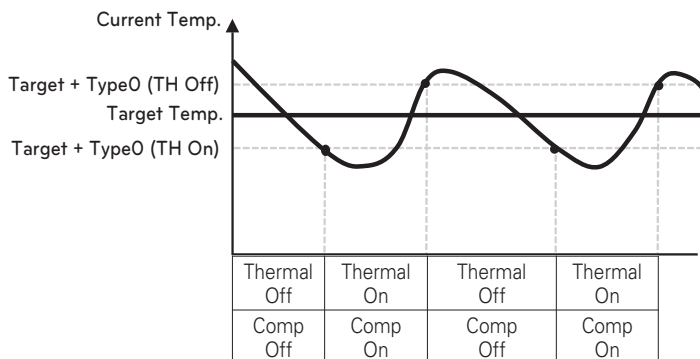

TH on/off Variable, heating water

It is a function to adjust the heating water temperature Thermal On / Off temperature according to the field environment in preparation for heating or heating claim.

- You can set the following setting values using [$<$, $>$ (left/right)] button.

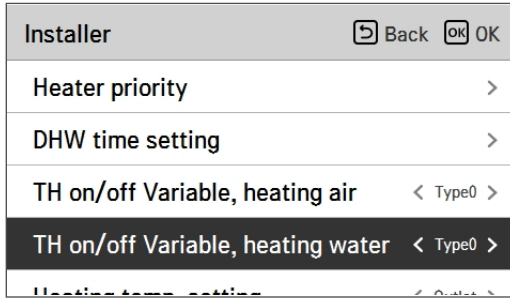

Value	Description	
	TH On	TH Off
Type0	-2 °C	2 °C
Type1	-3 °C	3 °C
Type2	-4 °C	4 °C
Type3	-1 °C	1 °C

- Example : Type0 setting

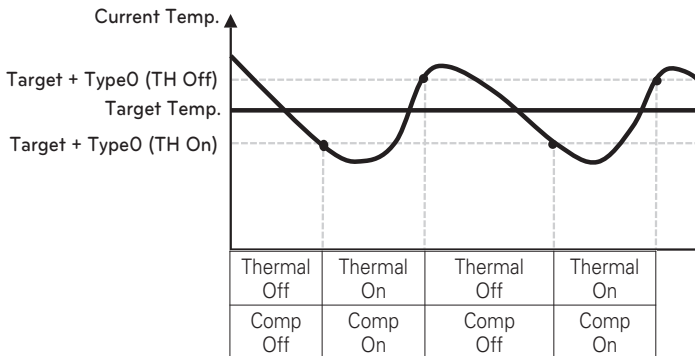

TH on/off Variable, cooling air

It is a function to adjust the cooling air temperature Thermal On / Off temperature according to the field environment in preparation for cooling or cooling claim.

- You can set the following setting values using [\leftarrow , \rightarrow (left/right)] button.

Installer	Back	OK
TH on/off Variable, heating air	<	Type0 >
TH on/off Variable, heating water	<	Type0 >
TH on/off Variable, cooling air	<	Type0 >
TH on/off Variable, cooling water	<	Type0 >
Pump setting in heating	<	>

Value	Description	
	TH On	TH Off
Type0	0.5 °C	-0.5 °C
Type1	1 °C	-1 °C
Type2	2 °C	-2 °C
Type3	3 °C	-3 °C

- Example : Type0 setting

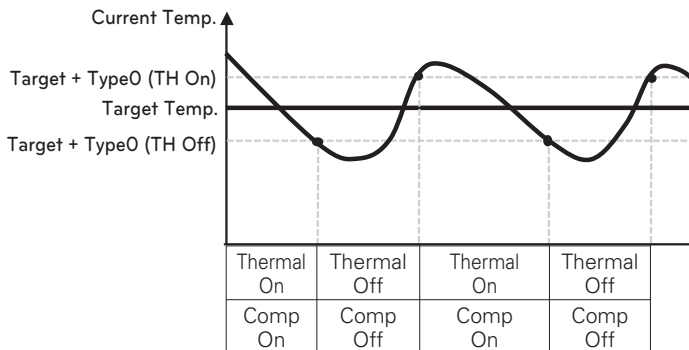

TH on/off Variable, cooling water

It is a function to adjust the cooling water temperature Thermal On / Off temperature according to the field environment in preparation for cooling or cooling claim.

- You can set the following setting values using [$<$, $>$ (left/right)] button.

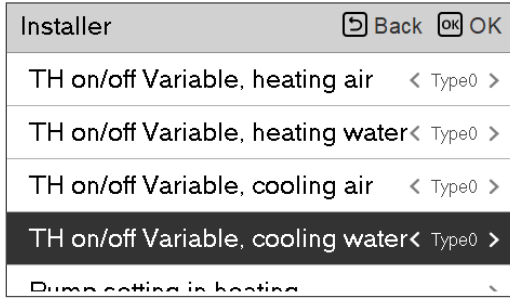

Value	Description	
	TH On	TH Off
Type0	0.5 °C	-0.5 °C
Type1	1 °C	-1 °C
Type2	2 °C	-2 °C
Type3	3 °C	-3 °C

- Example : Type0 setting

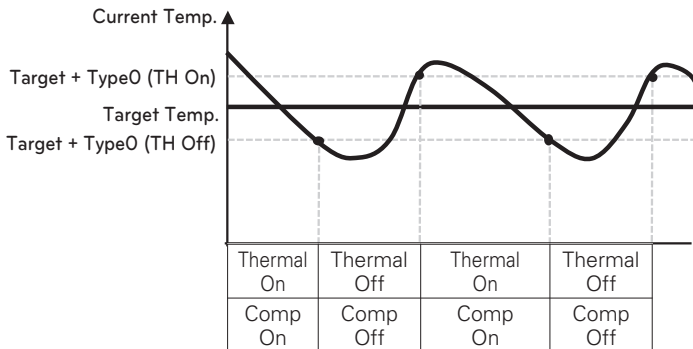

Heating temp. setting

- At the leaving water control in heating mode, the control reference water temperature position setting.
- If the air / leaving water temperature selection setting is set to leaving water temperature
- Change setting values using [<,>(left/right)] button

Installer	Back	OK
heater priority		
DHW time setting		>
TH on/off Variable, heating air	< Type0 >	
TH on/off Variable, heating water	< Type0 >	
Heating temp. setting	< Outlet >	

Value	
Outlet (Default)	Inlet

Cooling temp. setting

- At the leaving water control in cooling mode, the control reference water temperature position setting
 - If the air / leaving water temperature selection setting is set to leaving water temperature
- Change setting values using [,<,>(left/right)] button

Installer		Back	OK
Driv time setting			
TH on/off Variable, heating air	<	Type0	>
TH on/off Variable, heating water	<	Type0	>
Heating temp. setting	<	Outlet	>
Cooling temp. setting	<	Outlet	>

Value	
Outlet (Default)	Inlet

Pump setting in heating

- It is a function to help the water pump's mechanical life by putting the water pump's rest time
- Installer setting function to set water pump operation / delay time option in heating mode
- In the installer setting list, select Pump setting in heating category, and press [OK] button to move to the detail screen.

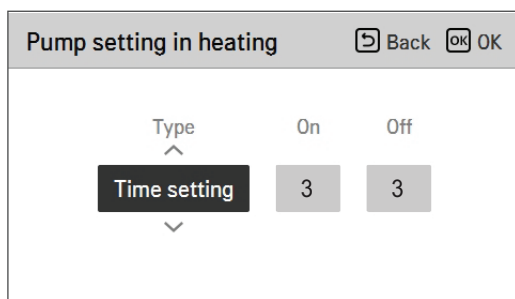
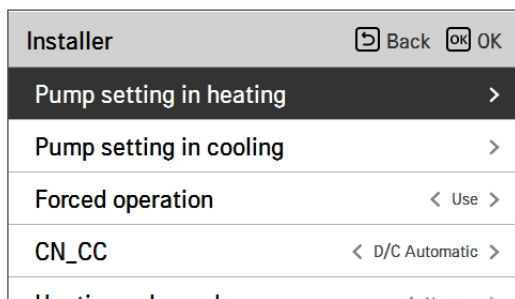

Value	Default	Range
Type	Time setting	Time setting / Continuous Operation
On	3 min	1 ~ 60 min
Off	3 min	1 ~ 60 min

* When Continuous Operation is selected, On, Off is disabled.

Pump setting. in cooling

- It is a function to help the water pump's mechanical life by putting the water pump's rest time
- installer setting function to set water pump operation / delay time option in cooling mode
- In the installer setting list, select Pump setting in cooling category, and press [OK] button to move to the detail screen.

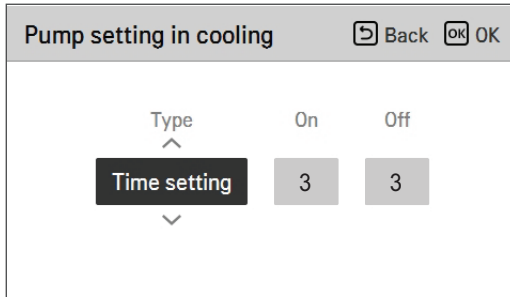
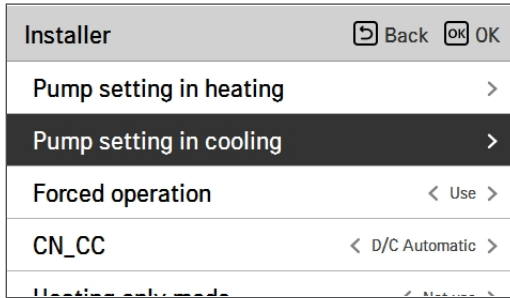

Value	Default	Range
Type	Time setting	Time setting / Continuous Operation
On	3 min	1 ~ 60 min
Off	3 min	1 ~ 60 min

* When Continuous Operation is selected, On, Off is disabled.

Forced operation

- If the product is not used for a long time, the pump will be forced to operate to prevent pump failure and PHEX freezing.
- Water pump off After 20 consecutive hours, disable / enable the logic that drives the water pump by itself.
- In the installer setting list, select Forced operation category, and press [OK] button to move to the detail screen.

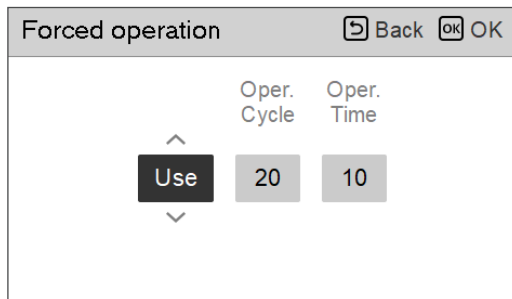
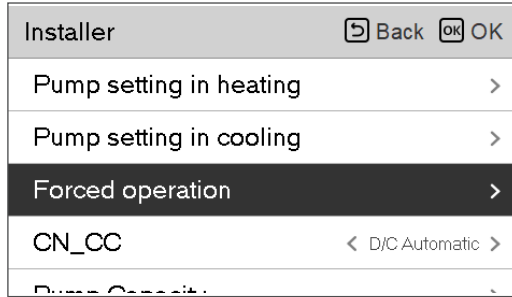

Value	Default	Range
-	Use	Use / Not Use
Oper. Cycle	20 hours	20 ~ 180 hours
Oper. Time	10 min	1 ~ 60 min

CN_CC

It is the function to set the usage of the unit's CN_CC port.

- Change setting values using [<,>(left/right)] button

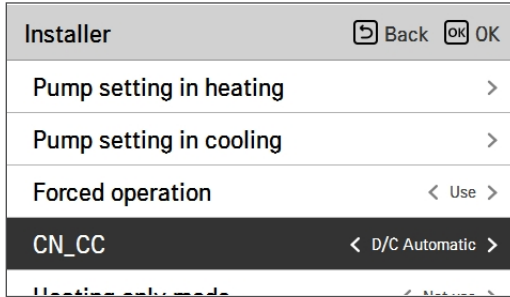

Value	Description
D/C Automatic	When power is applied to the product, the unit when the contact point is on in Dry Contact installed state recognizes Dry Contact installation
D/C Not Installed	Do not use (install) Dry Contact
D/C Installed	Use (install) Dry Contact

NOTE

CN_CC is the device connected to the unit to recognize and control the external contact point.

Pump Capacity

It is a function to enable installer to control Pump capacity application model.

- In the installer setting list, select Pump Capacity category, and press [OK] button to move to the detail screen.
- ΔT Control
 - This function automatically adjusts the pump capacity during heating operation. Automatically adjusts between the pump set volume and the minimum pump volume.
 - Minimum pump capacity will change from 40 % (Default) to suit the installation environment.

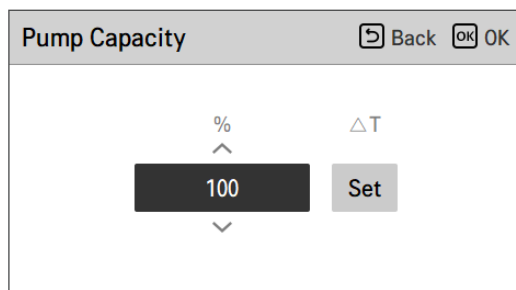
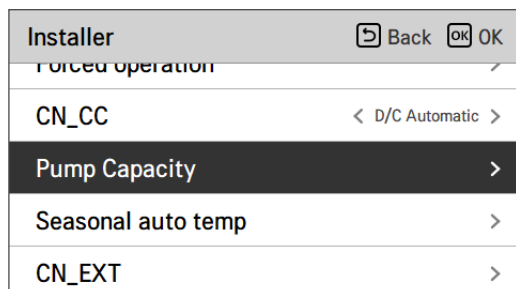

Value	Default	Range
%	100	10 ~ 100% change unit: 5
ΔT	Set	Set : Use Release : Not Use

Seasonal auto temp.

It is the function to set the operation reference value in Seasonal Auto mode.

- In the installer setting list, select Seasonal auto temp category, and press [OK] button to move to the detail screen.

Installer	Back OK
CN_CC	< Off Automatic >
Pump Capacity	>
Seasonal auto temp	>
CN_EXT	>
Add Zone	>



Seasonal auto temp	Back OK
Mode	< Heat >
Outdoor 1, Heat	< -10 >
Outdoor 2, Heat	< 16 >
Outdoor 3, Cool	< 30 >

Function	Description	Range	Default	Boundary
Outdoor1,Heat (Out1)	Heating lower ambient temp	-25 ~ 35 °C	-10 °C	Out1 ≤ Out2-1
Outdoor2,Heat (Out2)	Heating higher ambient temp		16 °C	Out2 ≥ Out1 +1 Out2 ≤ Out3 -5
Outdoor3,Cool (Out3)	Cooling lower ambient temp	10 ~ 46 °C	30 °C	Out3 ≥ Out2 +5 Out3 ≤ Out4 -1
Outdoor4,Cool (Out4)	Cooling higher ambient temp		40 °C	Out4 ≥ Out3 +1
Water1,Heat (LW1)	Heating higher water temp	Use heater : LW STD : 15~65 °C EW STD : 15~55 °C Not use heater : LW STD : 20~65 °C EW STD : 20~55 °C	35 °C	LW1 ≤ LW2
Water 2,Heat (LW2)	Heating lower water temp		28 °C	LW2 ≤ LW1
Water3,Cool (LW3)	Cooling higher water temp	Use FCU & 5 °C IDU : LW STD : 5~27 °C EW STD : 10~27 °C Use FCU & 6 °C IDU : LW STD : 6~27 °C EW STD : 11~27 °C Not use FCU : LW STD : 16~27 °C EW STD : 20~27 °C	20 °C	LW3 ≤ LW4
Water4,Cool (LW4)	Cooling lower water temp		16 °C	LW4 ≤ LW3
Air 1, Heat (RA1)	Heating higher air temp	16 ~ 30 °C	30 °C	RA1 ≤ RA2
Air 2, Heat (RA2)	Heating lower air temp		26 °C	RA2 ≤ RA1
Air 3, Cool (RA3)	Cooling higher air temp	18 ~ 30 °C	22 °C	RA3 ≤ RA4
Air 4, Cool (RA4)	Cooling lower air temp		18 °C	RA4 ≤ RA3

- Setting range: Celsius

- Seasonal Auto Driving mode: Heating, Heating & Cooling, Air-conditioning

* If heating mode is selected, heating & cooling or cooling can not be selected.

- Depending on the air / outflow control selection value, the water / air related setting value is displayed on the screen.

In this mode, setting temperature will follow outdoor temperature automatically. This mode adds the cooling season function to the conventional weather dependent operation mode.

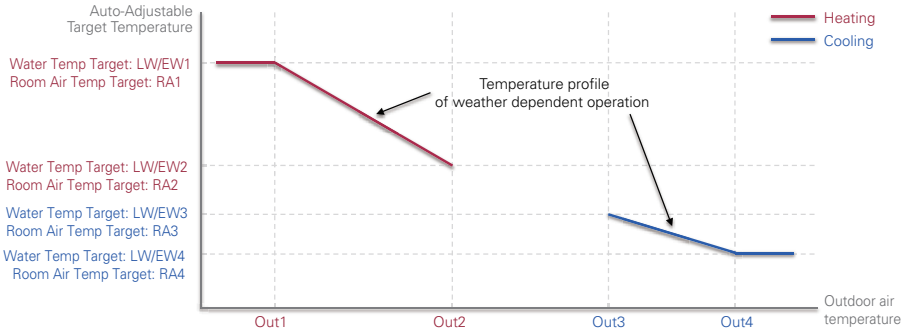

NOTE

DHW mode can be operated independently of seasonal auto temp mode.

Modbus Address

It is function to set the address of the Modbus device that is externally linked to the product. Modbus address setting function is available from indoor unit.

- In the installer setting list, select Modbus Address , and press [OK] button to move to the detail screen.

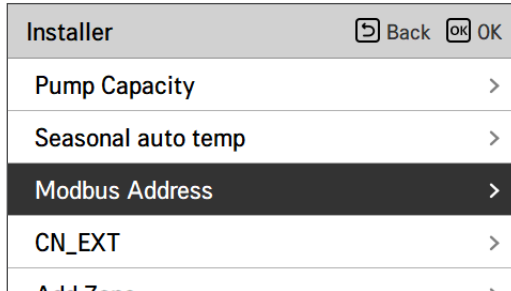

NOTE

To use this function, switch No.1 of option switch 1 must be turned ON.

CN_EXT

It is a function to control external input and output according to DI type set by customer using CN-EXT Port.

- In the installer setting list, select CN-EXT Port category, and press [OK] button to move to the detail screen.

The screenshot shows the 'Installer' menu with the following items: 'Seasonal auto temp', 'Modbus Address', 'CN_EXT' (highlighted in black), 'Add Zone', and 'Use External Pump'. The 'Back' and 'OK' buttons are visible at the top right.



The screenshot shows the 'CN_EXT' detail screen with four selectable options: 'Not use' (highlighted in black), 'Simple Operation', 'Simple Dry Contact', and 'Single emergency stop'. The 'Back' and 'OK' buttons are visible at the top right.

Value	Contact Input	Operation	Remark
Not Use	Open	-	-
	Close	-	-
Simple Operation	Open	OFF	-
	Close	ON	-
Simple Dry Contact	Open	OFF + Hard Lock	Follows Dry Contact mode : - Auto mode : if contact input closes, operation On - Manual mode : if contact input closes, keep in previous state - Hard lock: Unable to control the product
	Close	ON	
Single emergency stop	Open	Always OFF	Priority : - Emergency stop Lock > Central control Lock > Dry Lock
	Close	Emergency stop released	

Anti-freezing Temperature

Anti-freeze temperature setting is available in installer mode. It prevents frostbite from happening in the range of -25 to -5 degree celsius.

Make sure to use this function only when antifreeze is added.

- Change setting values using [**<**, **>**(left/right)] button

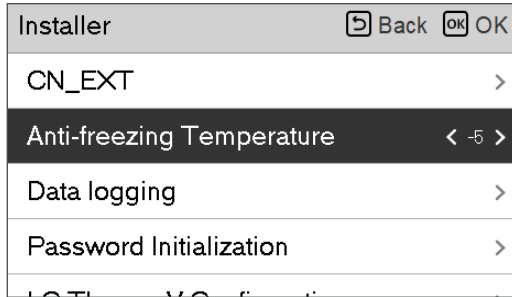

NOTE

To use this function, the antifreeze short pin(CN_FLOW2, Black) of indoor PCB must be remove and switch No.2 in option SW 3 must be on.

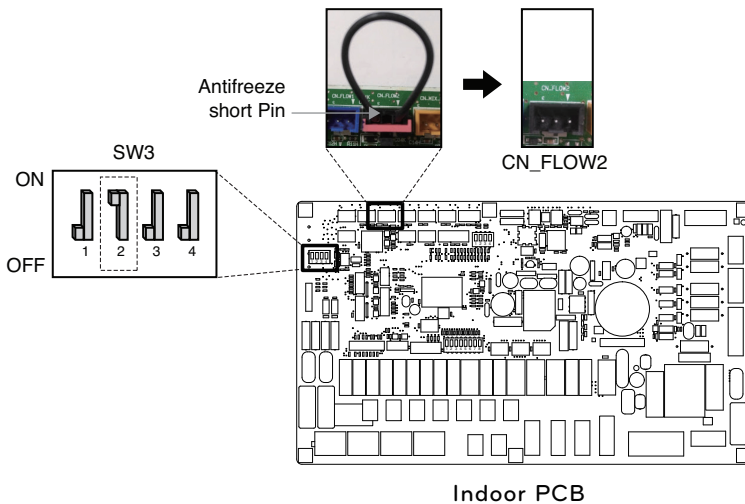

Add Zone

Function to set whether or not to use a installed 2nd circuit function using mixing kit.

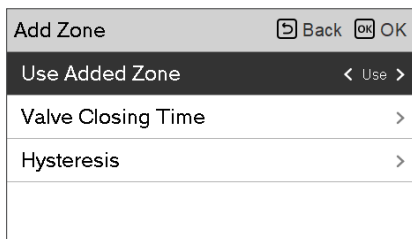
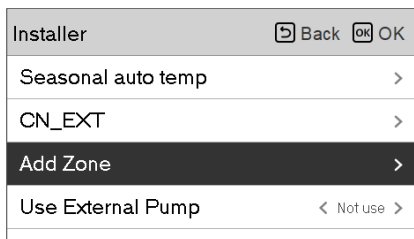

You can set valve closing time[seconds] and hysteresis temperature[°C] on screen by yourself.

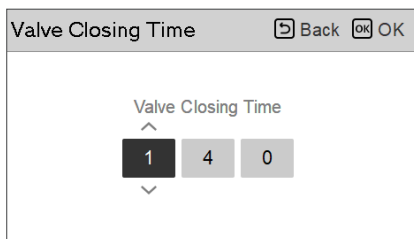

Value	Default	Range
Valve Closing Time	240 s	60 ~ 999 s
Hysteresis	2 °C	1 ~ 5 °C

Activating this function, It allows 2 zones (Circuit 1, Circuit 2) temperature to be controlled, separately.

- In case of heating, the temperature of Circuit 1 can not be set higher than Circuit 2 temperature.
- In case of cooling, the temperature of Circuit 1 can not be set lower than Circuit 2 temperature.

NOTE

Circuit 1 = Direct circuit : Zone where the water temperature is Highest when heating
 Circuit 2 = Mixing circuit : The other zone

Use External Pump

This function can be set to control the external water pump.

- In the installer setting list, select Use External Pump category, and press [OK] button to move to the detail screen.
- Heating/Cooling
 You can use this feature when you have installed a 3 Way valve to switch the water flow between the underfloor and the water tank. The external pump operates only in the direction of water flow in the underfloor.

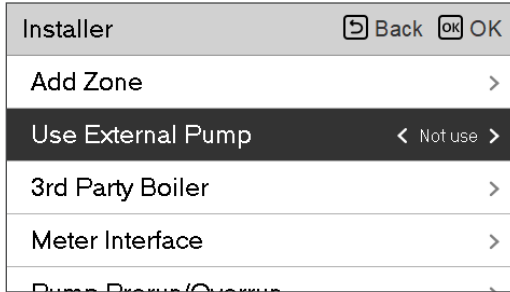

Value		
Not use	Use	Heating/Cooling

3rd Party Boiler

This function is to configure the 3rd party boiler to be controlled.

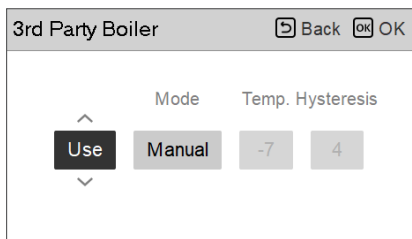
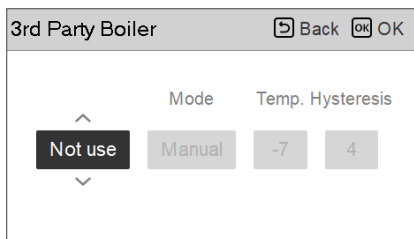

If the status of this function is "Use", you can choose control mode of boiler, Auto or Manual.

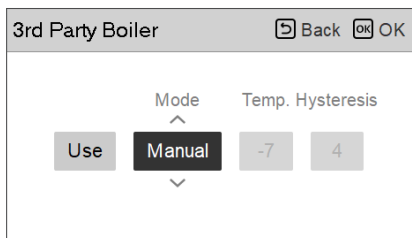
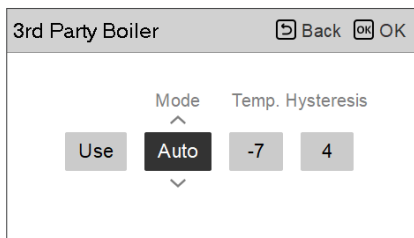

If the mode of this function is set to "Manual", you can set temperature of the boiler and hysteresis, respectively.

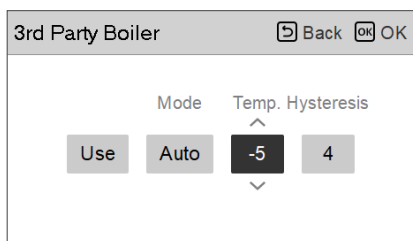

External boiler ON condition :

- If outdoor temperature \leq external boiler operation temperature value (installer setting), turn off the indoor unit and operate the external boiler.

External boiler OFF condition :

- If External air temperature \geq external boiler operation temperature value (installer setting) + Hysteresis (installer setting), turn off external boiler operation and operate indoor unit

Meter Interface

It is the function that can check the status of energy and power on screen. It collects and calculates power or calorie data to create data for energy monitoring and energy warning alarm pop-ups. This function can be activated in installer mode.

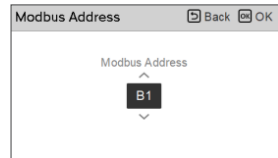
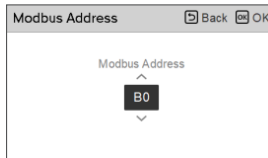
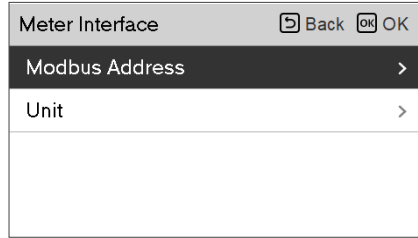
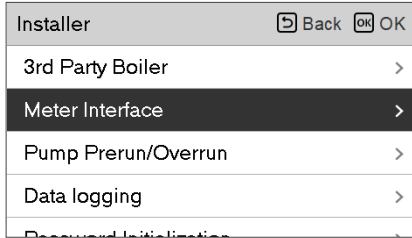

There are 2 options, modbus address and unit, in this function. Activating the modbus address option, you choose one address(B0 or B1) or don't use. Then, you set the port and specification in range of 0000.0~9999.9 [pulse/ kWh] as shown in the figure below.

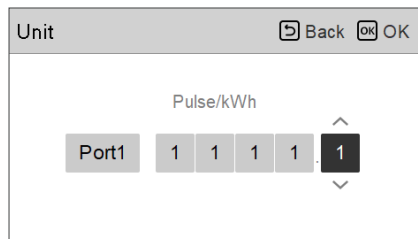
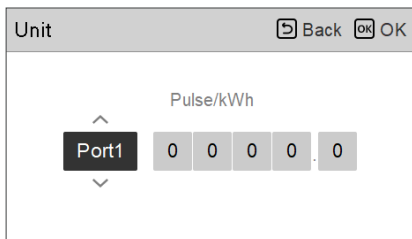

Pump Prerun/Overrun

Pump Prerun operates to ensure sufficient flow before the compressor is operated. This is a function that allows heat exchange to work smoothly.

Pump Overrun removes latent heat from the PHEX by circulating the water flow when the comp is stopped.

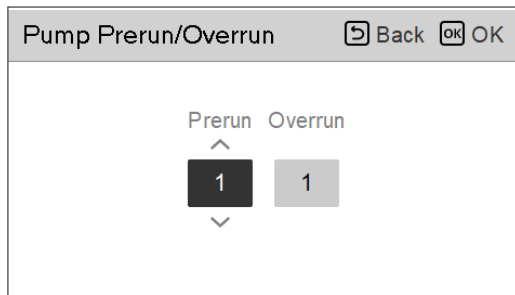
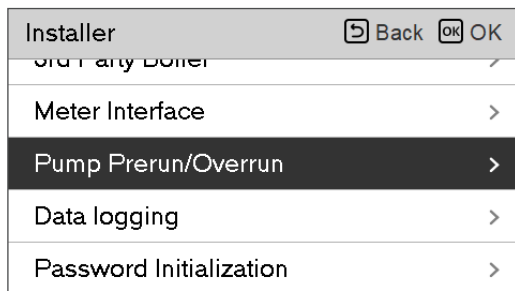

Value	Default	Range
Prerun	1 min	1~10 min
Overrun	1 min	1~10 min

Solar Thermal System

It is function to set operation reference value in Solar Thermal System.

In the installer setting list, select Solar thermal system category, and press [OK] button to move to the detail screen.

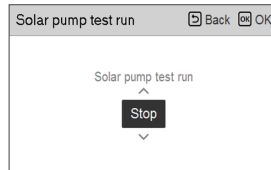
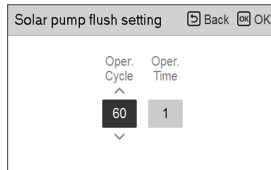
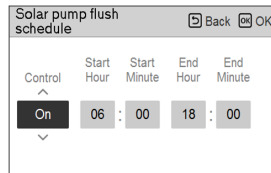
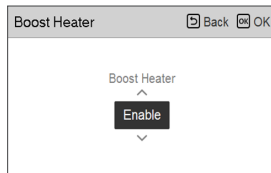
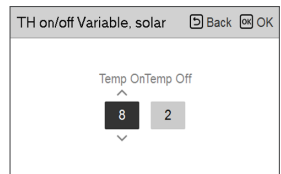
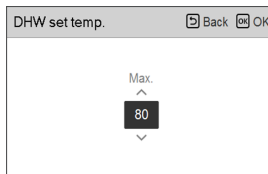
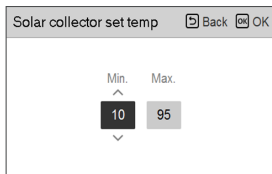
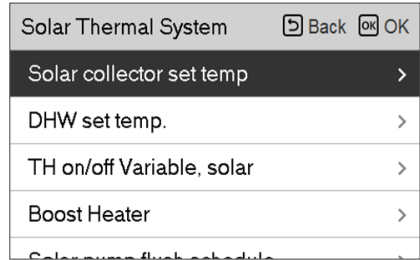
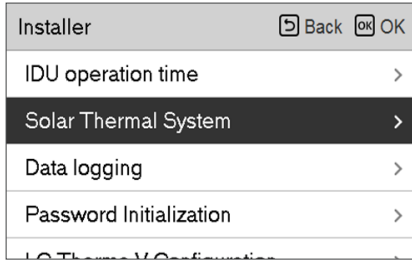

NOTE

To use this function, switch No.2 of option switch 2 must be turned ON and No.3 of option switch 2 must be turned OFF.

Descriptions for each parameters are as following.

- Solar collector set temp
 - Min temp : It is the minimum solar collector temperature at which the solar thermal system can operate.
 - Max temp : It is the maximum solar collector temperature at which the solar thermal system can operate
- TH on/off Variable, solar
 - Temp on : It is the temperature difference between the current solar thermal temperature and DHW tank temperature at which the solar thermal system operates.
 - Temp off : It is the temperature difference between the current solar thermal temperature and DHW tank temperature at which the solar thermal system stops.
 - Example : If the current solar collector temperature is 80 °C and Temp on is set to 8 °C, the solar thermal system operates when the DHW tank temperature is less than 72 °C. In the same case, if Temp off is set to 2 °C, Solar Thermal System stops when DHW temperature is 78 °C.
- DHW Set Temp
 - Max : It is maximum temperature of DHW that can be reached by solar thermal system.
- Boost Heater
 - Enable : DHW tank heater can be used when operating the Solar Thermal system.
 - Disable : DHW tank heater cannot be used when operating the Solar Thermal system.
- Solar pump flush schedule
 - It is the function to circulate the solar water pump intermittently for solar collector temperature detection when the solar water pump does not operate for a long time. Turn on to use this function.
- Solar Pump flush setting
 - Oper.Cycle : When using the solar pump flush function, the solar water pump operates at the set time.
 - Oper.Time : When using the solar pump flush function, the solar water pump operates during the set time.

Function	Value	Range	Default
Solar collector set temp	Min	5 °C ~ 50 °C	10 °C
	Max	60 °C~105 °C	95 °C
DHW set temp	Max	20 °C~90 °C	80 °C
TH on/off Variable, solar	Temp On	3 °C ~ 40 °C	8 °C
	Temp Off	1 °C ~ 20 °C	2 °C
Boost Heater	Boost Heater	Enable/Disable	Enable
Solar pump flush schedule	On/OFF	On/Off	On
	Start Hour, Start Minute	00:00 ~ 24:00	6:00
	End Hour, End Minute	00:00 ~ 24:00	18:00
Solar pump test run	Pump test Run	Start/Stop	Stop
Solar pump flush setting	Oper.Cycle	30 min ~ 120 min	60 min
	Oper.Time	1 min ~ 10 min	1 min

Energy state

This function is to control the product according to the energy state. When the charged state of ESS is transmitted, it changes the target temperature of heating, cooling and DHW by setting value according to energy state.

Select either Signal Mode or Modbus Mode according to the connection type between the product and the ESS.

Installer	Back OK
IDU operation time	>
RMC master/slave	< Master >
Energy state	>
Data logging	>
Password Initialization	>



Energy state	Back OK
ESS use type	< Not use >
Energy state definition	>
Digital input assignment	>

Value	Default
Not Use	Not use
Use Modbus	
Use Digital Input	

Energy state definition		Back	OK
Energy state 5	>		
Energy state 6	>		
Energy state 7	>		
Energy state 8	>		



Energy state 5		Back	OK
	Heat Temp.	Cool Temp.	DHW Temp.
Use	5	-5	30

Division	Value	Default	Range	Division	Value	Default	Range
ES 1	-	Use	Use / Not Use	ES 5	-	Use	Use / Not Use
	Heat Temp.	Off	fixed		Heat Temp.	+5 °C	0 ~ 30 °C
	Cool Temp.	Off	fixed		Cool Temp.	-5 °C	-30 ~ 0 °C
	DHW Temp.	Off	fixed		DHW Temp.	+30 °C	0 ~ 50 °C
ES 2	-	Use	Use / Not Use	ES 6	-	Use	Use / Not Use
	Heat Temp.	Normal	fixed		Heat Temp.	+2 °C	0 ~ 30 °C
	Cool Temp.	Normal	fixed		Cool Temp.	-2 °C	-30 ~ 0 °C
	DHW Temp.	Normal	fixed		DHW Temp.	+10 °C	0 ~ 50 °C
ES 3	-	Use	Use / Not Use	ES 7	-	Use	Use / Not Use
	Heat Temp.	+2 °C	fixed		Heat Temp.	-2 °C	-30 ~ 0 °C
	Cool Temp.	0 °C	fixed		Cool Temp.	+2 °C	0 ~ 30 °C
	DHW Temp.	+5 °C	fixed		DHW Temp.	0 °C	-50 ~ 0 °C
ES 4	-	Use	Use / Not Use	ES 8	-	Use	Use / Not Use
	Heat Temp.	0 °C	fixed		Heat Temp.	-5 °C	-30 ~ 0 °C
	Cool Temp.	0 °C	fixed		Cool Temp.	+5 °C	0 ~ 30 °C
	DHW Temp.	80 °C	fixed		DHW Temp.	0 °C	-50 ~ 0 °C

* ES = Energy state

* ES 4 DHW Temp. 80 °C is the desired temperature value, not the offset.

When Signal Mode of EES use type is selected, press the Digital Input Assignment button to set the energy state according to the input signal.

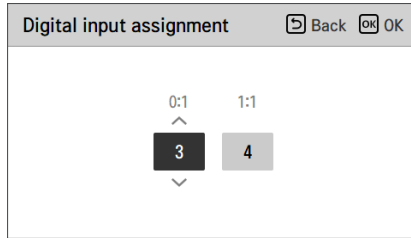

Value	Input Signal		Output state	
	TB_SG1	TB_SG2	Default	Range
X	0	0	ES2	fixed
X	1	0	ES1	fixed
0:1	0	1	ES3	ES3-ES8
1:1	1	1	ES4	

Data logging

It is the function to set the operation reference value in Seasonal Auto mode.

- In the installer setting list, select Data logging category, and press [OK] button to move to the detail screen.

Installer		Back	OK
Heating only mode	<	NO USE	>
Pump frequency setting(PWM)			>
Smart Grid(SG)			>
Seasonal auto temp			>
Data logging			>



Data logging					Back
Date	Time	Oper.	Settemp	In/Out	
1970.01.01	00:10	Off	-	24° / 25°	
1970.01.01	00:09	Off	-	24° / 25°	
1970.01.01	00:09	Off	-	24° / 25°	>
1970.01.01	00:09	Off	-	24° / 25°	
1970.01.01	00:09	Off	-	24° / 25°	

NOTE

Error history lookup range: 50

Error history information

Item: date, time, mode (including Off), set temperature, incoming temperature, outgoing temperature, room temperature, Hot water operation / stop, Hot water set temperature, Hot water temperature, Outdoor unit On / Off, Error code

Number of Display: Within 50

- Save criteria ▾

- Error occurred, released
- ON / OFF of outdoor unit operation

Password Initialization

It is the function to initialize (0000) when you forgot the password set in the remote controller.

- In the installer setting list, select the password initialization setting category, and press [OK] button to move to the detail screen.
- When you press "initialization" button, a popup screen appears, and when you press "check" button, password initialization starts, and the user password is changed to 0000.

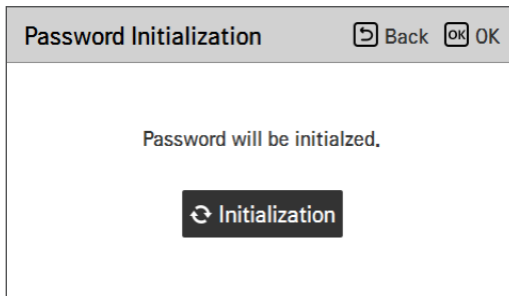
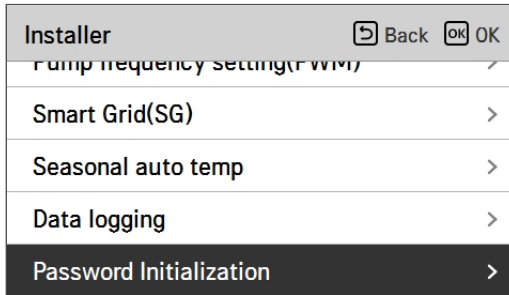

INSTALLER SETTING (For 4 Series)

- You can set the product user functions.
- Some functions may not be displayed/operated in some product types.

Segmentation	Functions	Description
Configuration	Select Temperature Sensor	Selection for setting temperature as air temperature or leaving water temperature or air + leaving water temperature
	Use Heating Tank Heater	Set up to control booster heater
	Mixing Circuit	This function is to use mixing circuit function. Set enable/disable mixing circuit function and valve closing time and hysteresis.
	Use External Pump	Set up to control an external water pump
	RMC master/slave	Function to use 2 remote control environment
	LG Therma V Configuration	Function to save the environment settings of the product for use in LG Therma V Configurator through SD Card.
General settings	Forced operation	Water pump off After 20 consecutive hours, disable / enable the logic that drives the water pump by itself
	Pump Prerun/Overrun	Set to reach the optimum flow rate by circulating the heating water with the water pump before heat exchange. After the operation stop, additional water pump is activated to circulate the heating water.
	Water Flow Control	Set water pump to control the water flow
	Energy Monitoring	Set up to use energy monitoring function of unit
	Anti-Freezing Operation	This function is to turn on/off the freeze prevention operation of the pump when the remote control is off.
	Password Reset	It is the function to initialize (0000) the password when you forgot the password set in the remote controller.
Room Heating	Heating temp. setting	At the water control in heating mode, the control reference water temperature position setting
	Air heating set temp.	Adjusting range of 'Setting Air Temperature' in heating mode
	Water heating set temp.	Adjusting range of 'Setting Heating Flow Temperature' in heating mode
	Hysteresis Heating Water	Heating Water Outlet Temperature Hysteresis range setting
	Hysteresis Room Air (Heating)	Heating air temperature Hysteresis range setting
	Pump setting in heating	Set water pump on/off interval option during thermo off condition in heating mode
	Heater on temperature	Setting outdoor air temperature where half capacity of backup heater starts operation.
	Screed drying	This function controls floor heating to a specific temperature for a certain period of time to cure floor cement

Segmentation	Functions	Description
Room Cooling	Cooling temp. setting	At the water control in cooling mode, the control reference water temperature position setting
	Air cooling set temp.	Adjusting range of 'Setting Air Temperature' in cooling mode
	Water cooling set temp.	Adjusting range of 'Setting Leaving Water Temperature' in cooling mode
	Water supply off temp. during cooling	Determine the leaving water temperature which blocks the flow into underfloor coil in cooling mode. This function is used for preventing condensation on the floor in cooling mode
	Hysteresis Cooling Water	Cooling Water Outlet Temperature Hysteresis range setting
	Hysteresis Room Air (Cooling)	Cooling air temperature Hysteresis range setting
	Pump setting in cooling	Set water pump on/off interval option during thermo off condition in cooling mode
Auto mode	Seasonal auto temp	Set the operating temperature in Seasonal Auto mode
Domestic hot water	DHW set temp.	Setting DHW set temperature
	Tank disinfection setting 1	Setting start/maintain time for disinfection
	Tank disinfection setting 2	Setting disinfection temperature
	Tank setting 1	Setting minimum and maximum temperature using heat pump cycle for DHW heating
	Tank setting 2	Setting temperature hysteresis and heating priority (DHW heating or floor heating)
	Heater priority	Determine usage of backup heater and booster heater
	DHW time setting	Determine follow time duration : operation time of domestic hot water tank heating, stop time of domestic hot water tank heating, and delay time of DHW tank heater operating
	Recirculation time	Whether to use the recirculation function and set the water pump on/off interval option
Solar thermal	Solar Thermal System	Function to set operation reference value in Solar Thermal System.
Service	Pump test run	Water pump test run
	Frost Protection Temp.	This function is to apply an offset to the freezing temperature of the freeze protection logic when using antifreeze mode

Segmentation	Functions	Description
Connectivity	Dry Contact Mode	Dry contact function is the function that can be used only when the dry contact devices is separately purchased and installed.
	Central Control Address	When connecting the central control, set the central control address of the unit.
	CN_CC	It is the function to set whether to install (use) Dry Contact. (It is not a function for Dry Contact installation, but it is a function to set the usage of the unit's CN_CC port.)
	CN_EXT	Function to set external input and output control according to DI / DO set by customer using dry contact port of indoor unit. Determine the use of the contact port (CN_EXT) mounted on the indoor unit PCB
	3rd Party Boiler	Configuration to control 3rd party boiler
	Meter Interface	When installing the meter interface to measure energy / calorie in the product, set unit spec for each port
	Energy state	Select whether to use or not use the SG Mode function of the product, set the operation option value in SG1 step.
	Thermostat control type	Setting Thermostat control type
	Modbus Address	It is function to set the address of the Modbus device that is externally linked to the product. Modbus address setting function is available from indoor unit.
Info	Pump operation time	Display water pump's operation time
	IDU operation time	Display Indoor Unit's operation time
	Current Flow Rate	Function to check the current flow rate.
	Data logging	Display error and operation history of connected unit

Select Temperature Sensor

The product can be operated according to air temperature or water temperature. The selection for setting temperature as air temperature or water temperature is determined.

- In the installer setting list, Select Temperature Sensor category, and press [OK] button to move to the detail screen.

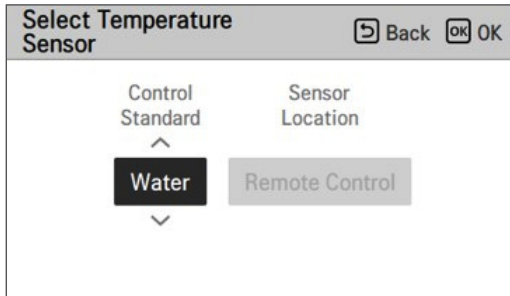
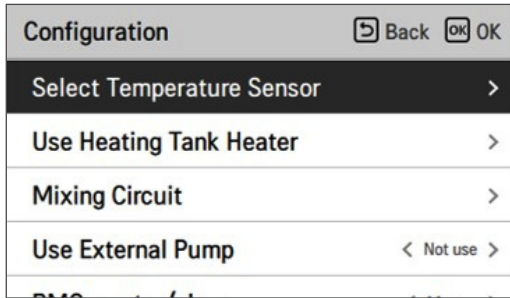

Value	Default	Range
Control Standard	Water	Water / Air / Air + Water
Sensor Location	Remote Control	Remote Control / Indoor Unit

* When Water is selected, Sensor Location is disabled.

NOTE

- Set DIP switch No. 5 of option switch 2 to 'ON' in order to use remote temperature sensor.
- When the sensor location is set to Remote Control, the RS3 controller must be placed inside of suitable Reference room.

Use Heating Tank Heater

This is a function to change the set value for the operation of the hot water tank heater, such as heating tank heater use /not use and heater delay time.

- In the installer setting list, Select Configuration category, and press [OK] button to move to the detail screen.

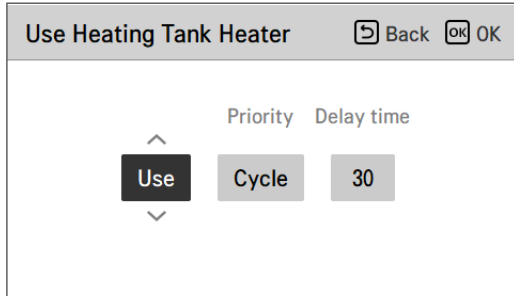
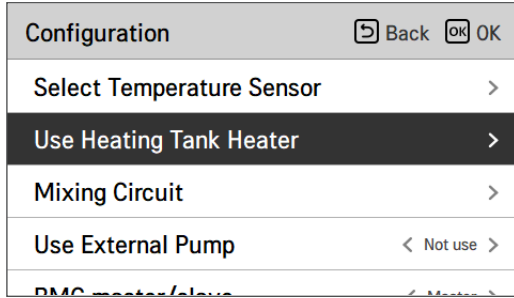

Value	Default	Range
-	Use	Use / Not Use / Use disinfect
Priority	Cycle	Cycle / Heater/Cycle
Delay time	30 min	10 / 20 / 30 / 40 / 50 / 60 / 90 / 120 / 1440 min

Mixing Circuit

Function to set whether or not to use an installed mixing circuit function using mixing kit.

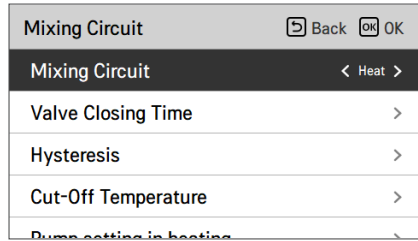
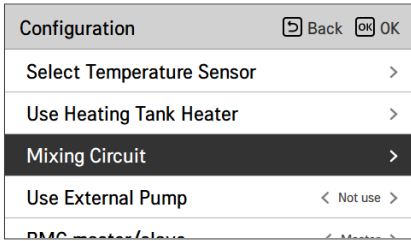

Value	Default
Not Use / Heat / Cool	Not Use

You can set valve closing time[s] and hysteresis temperature[°C] on screen by yourself. Setting the cut-off temperature protects the water from flowing over the cut-off temperature in the mixing circuit during heating operation.

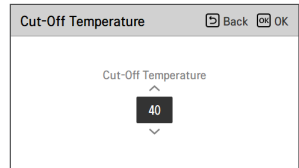
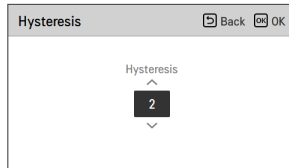

Value	Default	Range
Valve Closing Time	240 s	60 ~ 999 s
Hysteresis	2 °C	1 ~ 3 °C
Cut-Off Temperature	40 °C	20 ~ 65 °C

You can set the operation of the outdoor unit when only the mixing circuit is operating and the direct circuit is not operating.

Type1	Type2 (Default)
Outdoor Operation	Outdoor Not Operation

Mixing Circuit	Back	OK
Hysteresis		>
Cut-Off Temperature		>
Pump setting in heating		>
Pump setting in cooling		>
Comp. Operation	< Type2	>

Value	Default
Type 1 / Type 2	Type 2

CAUTION

Set Type 1 only at the installation site with a small load or no buffer tank.

When setting Type 1 in a site with a large load or a site with a buffer tank, overheating may occur in the direct circuit.

Installer setting function to set water mixing pump operation / delay time option in heating/cooling mode

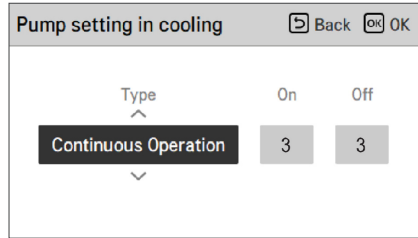
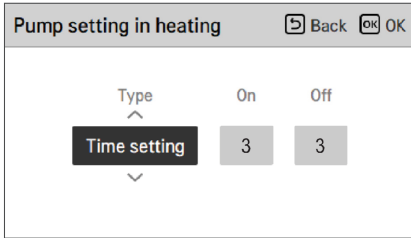

Value	Default	Range
Type	Time Setting	Time Setting / Continuous Operation
On	3 min	1 ~ 60 min
Off	3 min	1 ~ 60 min

* When Continuous Operation is selected, On, Off is disabled.

Activating this function, It allows 2 circuits (Circuit 1, Circuit 2) temperature to be controlled, separately.

NOTE

When using the Mixing Circuit function, the external pump setting must be changed to 'Circuit 1'.

Use External Pump

This function can be set to control the external water pump.

- In the installer setting list, select Use External Pump category, and press [OK] button to move to the detail screen.
- Heating/Cooling
You can use this feature when you have installed a 3 Way valve to switch the water flow between the underfloor and the water tank. The external pump operates only in the direction of water flow in the underfloor.
- Circuit1
This function controls the external pump when operating the mixing circuit. The external pump should be controlled according to Th/on and Th/off in Circuit1(Direct circuit). Therefore, when using the mixing circuit, be sure to set the external pump to 'Circuit1'.

Configuration		Back	OK
Use heating tank heater			
Mixing Circuit			
Use External Pump	< Not use >		
RMC master/slave	< Master >		
LG Therma V Configuration			

Value			
Not use (Default)	Use	Heat & Cool	Circuit1

RMC master/slave

This function can be select Master/Slave on remote controller to use 2 Remote Control environment

- In the Installer setting list, and select RMC master/slave setting category, and press [,<,>(left/right)] button to following setting values.

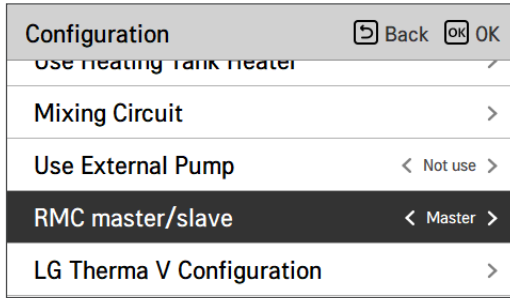

Value	
Master (Default)	Slave

LG Therma V Configuration

This function can be set to save the environment settings of the product for use in LG Therma V Configurator through SD Card.

- In the Installer setting list, and select LG Therma V Configuration setting category, and press [OK] button to move to the detail screen.

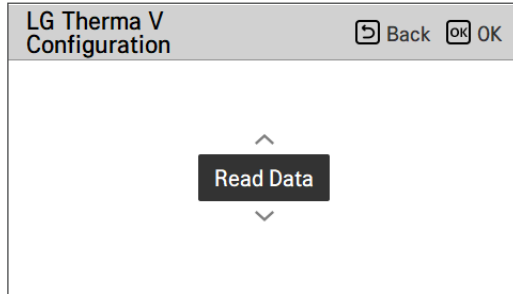
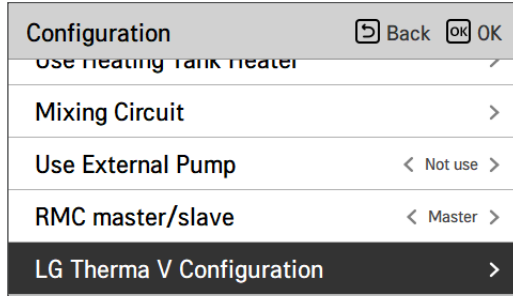

Value	
Read Data (Default)	Save Data

NOTE

When saving the environment setting of the product in the SD card, be sure to save the file name as 'RS3_AWHP_DATA'.

Forced operation

- If the product is not used for a long time, the pump will be forced to operate to prevent pump failure and PHEX freezing.
- Water pump off After 20 consecutive hours, disable / enable the logic that drives the water pump by itself.
- In the installer setting list, select Forced operation category, and press [OK] button to move to the detail screen.

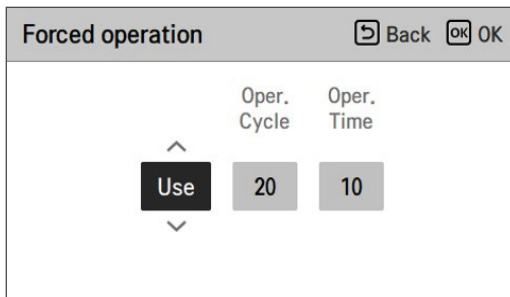
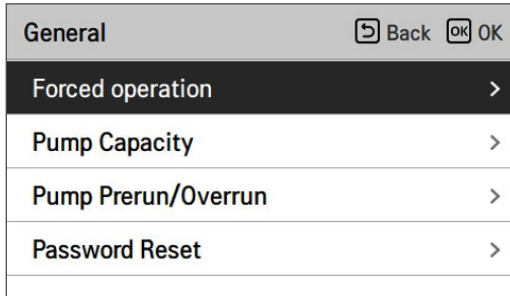

Value	Default	Range
-	Use	Use / Not Use
Oper. Cycle	20 hours	20 ~ 180 hours
Oper. Time	10 min	1 ~ 60 min

Pump Prerun/Overrun

Pump Prerun operates to ensure sufficient flow before the compressor is operated. This is a function that allows heat exchange to work smoothly.

Pump Overrun removes latent heat from the PHEX by circulating the water flow when the comp is stopped.

General	Back	OK
Forced operation		>
Pump Prerun/Overrun		>
Water Flow Control		>
Password Reset		>



Pump Prerun/Overrun	Back	OK
Prerun	Overrun	
1	1	

Value	Default	Range
Prerun	1 min	1~10 min
Overrun	1 min	1~10 min

Water Flow Control

This function controls the water flow by controlling the water pump. Select the way to control the water pump and set the target value

- In the installer setting list, select Configuration category, and press [OK] button to move to the detail screen.
- Optimal Flow Rate
The water pump is automatically controlled at the optimum flow rate required according to the desired temperature of the Main screen.
- Pump Capacity
It operates with the capacity set for the water pump.
- Fixed Flow Rate
The water pump is automatically controlled to maintain the set flow rate.
- Fixed ΔT
Set the target ΔT (* ΔT = temperature difference between inlet and outlet water temperature)
The water pump is automatically controlled to maintain the set ΔT .

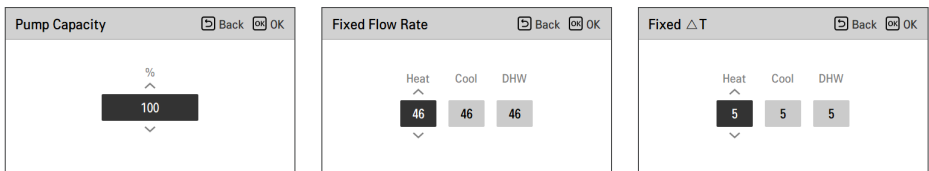
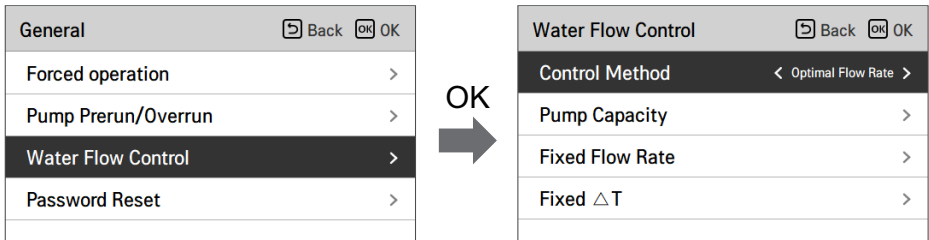

Flow Control Method			
Optimal Flow Rate (Default)	Pump Capacity	Fixed Flow Rate	Fixed ΔT

Energy Monitoring

This function can be set to use energy monitoring function of unit.

- Change setting values using [\leftarrow , \rightarrow (left/right)] button.

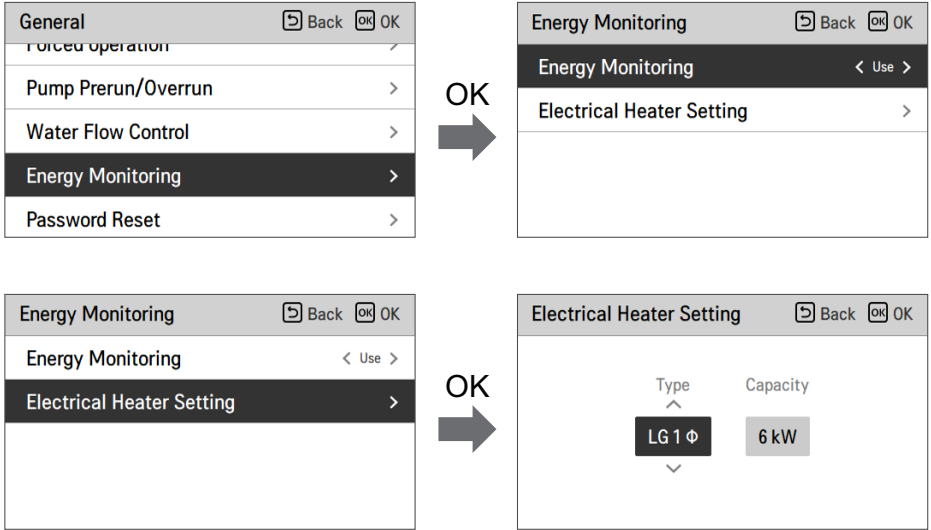

Value		Default	Range
Energy Monitoring		Use	Use/Not Use
Electric Heater Setting	Type	LG 1Ø	LG 1Ø / LG 3Ø / EXTERNAL
	Heater Capacity	6 kW	1 kW ~ 10 kW

Anti-Freezing Option 1

This function is to select whether to use Type1 or Type2 to prevent freezing when the remote control is turned off.

- Change setting values using [,>(left/right)] button.

General	⏪ Back	OK OK
Pump Priority/Overrun		>
Water Flow Control		>
Energy Monitoring		>
Anti-Freezing Option 1	< Type1	>
Password Reset		>

Value	
Type1(Default)	Type2

CAUTION

If the function is set to Type 2, there is a risk of freezing.

Function	Detection	Case	Operation
Type 1	Type 2 + Inlet Water Temp.	Air Temp. < Certain Level and Inlet Water Temp. < Certain Level	Pump always ON
		Air Temp. < Certain Level and Inlet Water Temp. > Certain Level	Pump intermittently On
		Air Temp. > Certain Level and Inlet Water Temp. > Certain Level	Pump always OFF
Type 2	Air Temp.	Air Temp. < Certain Level	Pump intermittently On
		Air Temp. > Certain Level	Pump always OFF

Password Reset

It is the function to initialize (0000) when you forgot the password set in the remote controller.

- In the installer setting list, select the password Reset setting category, and press [OK] button to move to the detail screen.
- When you press "Reset" button, a popup screen appears, and when you press "check" button, password initialization starts, and the user password is changed to 0000.

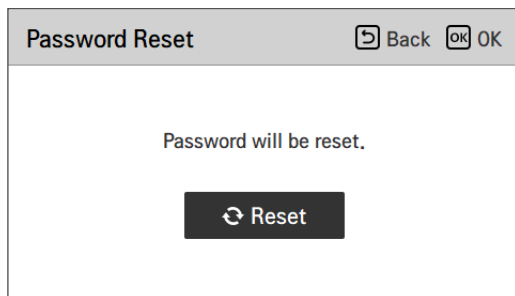
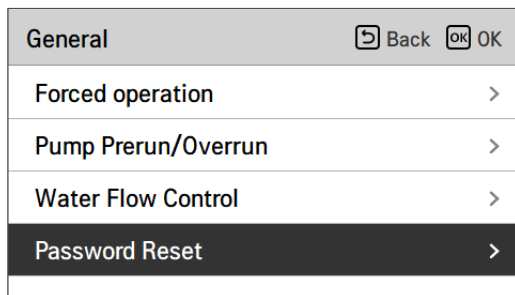

Screed drying

This function is a unique feature of AWHP that, when AWHP is installed in a new concrete structure, controls the specific temperature floor heating out temperature for a certain period of time to cure the floor cement.

- In the installer setting list, select Screed drying category, and press [OK] button to move to the detail screen.

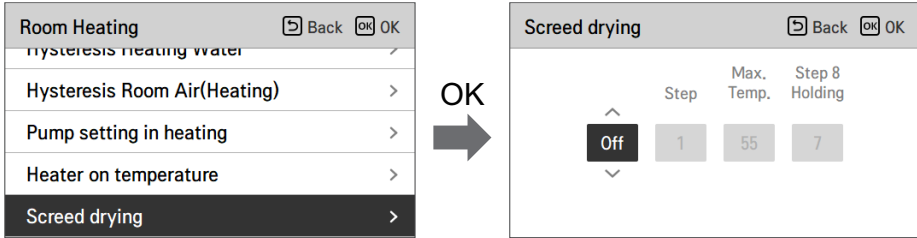

How to display

Main Screen - Displays 'Screed drying' on the desired temperature display. The step in progress at the bottom of the display is displayed.

Setting value

- Start-up step: 1 ~ 11
- Maximum temperature : 35 °C ~ 55 °C (Default : 55 °C)
- Step 8 Holding time : 1 days ~ 30 days (Default : 7 days)

Function operation

- It is performed by the following procedure from the selected starting step.
- After all steps are completed, turn off the cement curing operation.

Value	Step										
	1	2	3	4	5	6	7	8	9	10	11
LWT	25 °C	Max. T	Off	25 °C	35 °C	45 °C	Max. T	Max. T	45 °C	35 °C	25 °C
Duration	72 h	96 h	72 h	24 h	24 h	24h	24 h	Holding time	72 h	72 h	72 h

* LWT: Leaving Water Target Temp.

* Holding time range : 1 ~ 30 day(default: 7 day)

- ※ If the upper limit setting value of the heating LW temperature is 55 °C or lower, it is set to 55 °C forcibly.
If the lower limit setting value of the heating LW temperature is 25 °C or higher, it is set to 25 °C forcibly.

NOTE

- During Screed drying operation, button input except for installer function and temperature display is restricted.
- When the power is applied again after a power outage during product operation, the product operation state before power failure is remembered and the product is automatically operated.
- Screed drying operation stops when an error occurs / When error is cleared, restart cement Screed drying. (However, if the wired remote control is reset to the error occurrence state, it is compensated in the unit of one day)
- Upon releasing after an error, Screed drying operation may take up to 1 minute of waiting time after boot up. (The Screed drying operation status is judged as 1 minute cycle.)
- During Screed drying operation, installer function Screed drying operation is selectable.
- During Screed drying operation, starting operation, low noise mode off, low noise time setting off, hot water off, solar heat off.
- During Screed drying operation, simple, sleep, on, off, weekly, holiday, heater does not execute reservation operation.

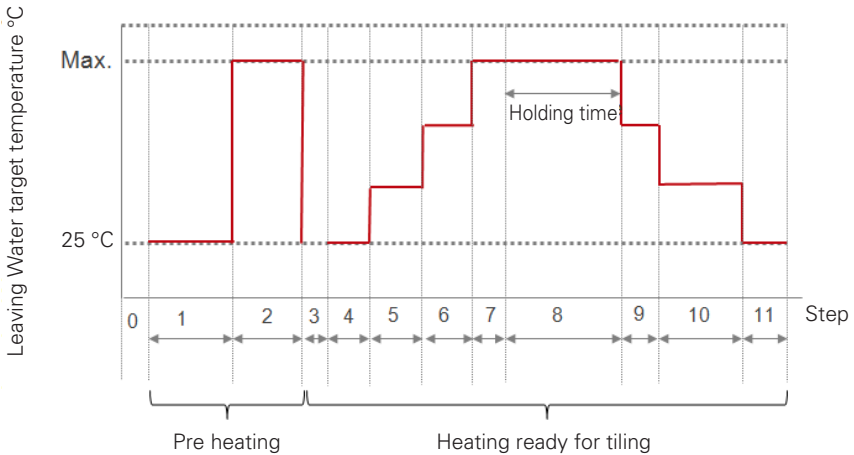

Heater on temperature

Depending on local climatic conditions, it is necessary to change the temperature condition in which backup heater turns on / off.

- In the installer setting list, Heater on temperature category, and press [OK] button to move to the detail screen.

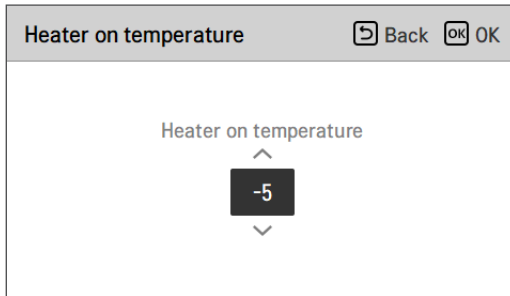
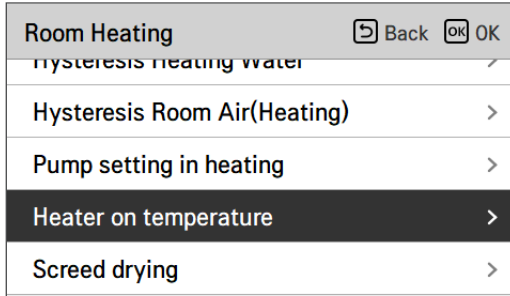

Value	Default	Range
Heater on temperature	-5 °C	-25 ~ 18 °C

Air heating set temp.

Determine heating setting temperature range when air temperature is selected as setting temperature

- In the installer setting list, select Air heating set temp. category, and press [OK] button to move to the detail screen.

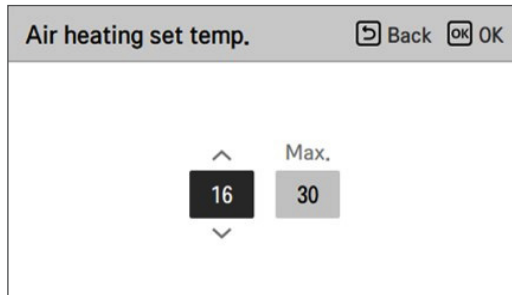
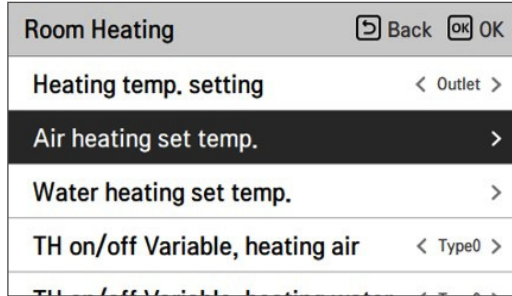

Value	Default	Range
Min	16 °C	16 ~ 22 °C
Max	30 °C	24 ~ 30 °C

NOTE

It is possible to control the unit based on room air temperature by using either remote air temperature sensor or wired remote controller (RS3).

- Remote room air sensor is an accessory (PQRSTA0) and sold separately.
- DIP switch setting (No. 5 of Indoor unit Option Switch 2) and installer setting (Select Temperature Sensor) should be set properly in order to use remote room air temperature sensor (PQRSTA0).

Water heating set temp.

Determine heating setting temperature range when water temperature is selected as setting temperature.

- In the installer setting list, select Water heating set temp. category, and press [OK] button to move to the detail screen.

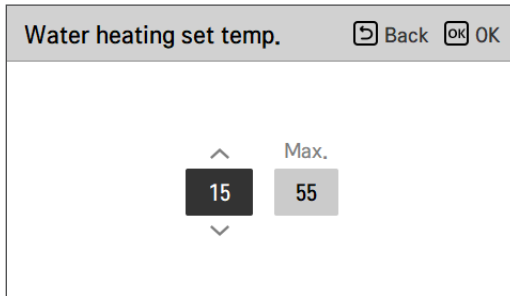
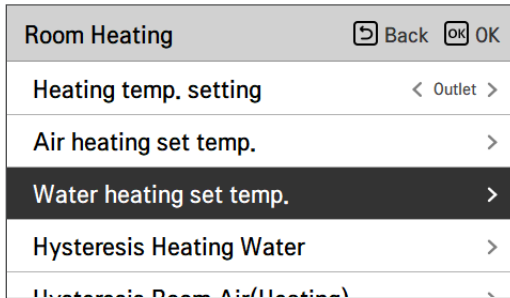

Value	Default	Range
Min	15 °C	15 ~ 34 °C
Max	55 °C	35 ~ 65 °C

NOTE

- When the backup heater is not used, the minimum temperature of the water temperature can be set in the range of 34 °C to 20 °C. (Default : 20 °C)

Hysteresis Room Air(Heating)

It is a function to adjust the heating air temperature Thermal On / Off temperature according to the field environment in order to offer optimized heating operation.

- In the Installer setting list, and select Hysteresis Room Air(Heating) category, and press [OK] button to move to the detail screen.

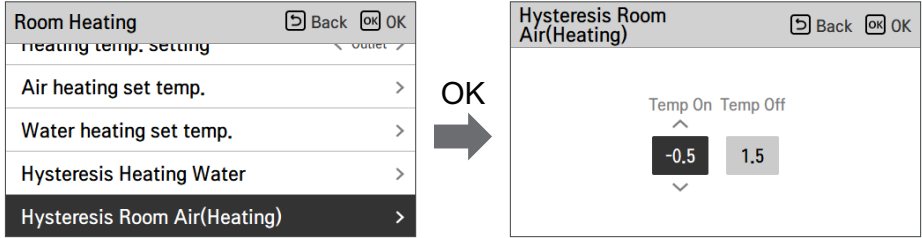

Value	Default	Range
Temp On	-0.5 °C	-3 ~ 0 °C
Temp Off	1.5 °C	0 ~ 4 °C

- Example : Type0 setting

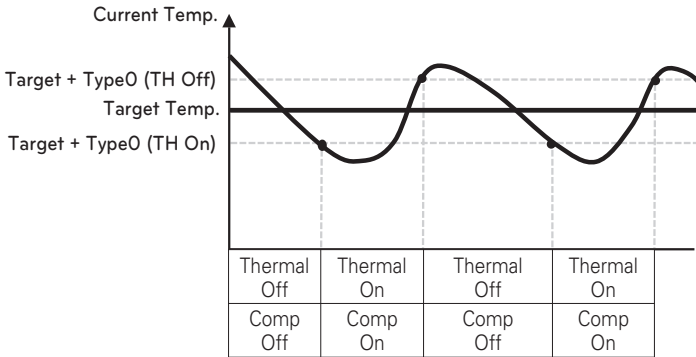

Hysteresis Heating Water

It is a function to adjust the heating water temperature Thermal On / Off temperature according to the field environment in order to offer optimized DHW heating operation.

- In the Installer setting list, and select Hysteresis Heating Water category, and press [OK] button to move to the detail screen.

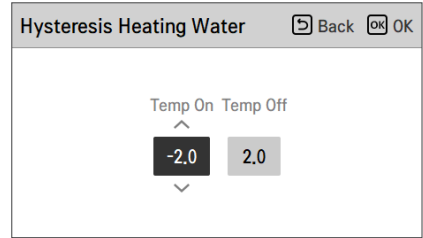
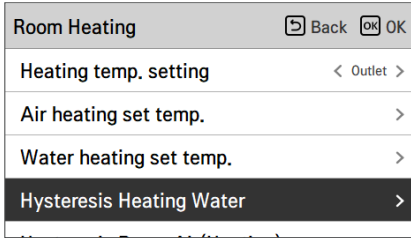

Value	Default	Range
Temp On	-2 °C	-9 ~ 0 °C
Temp Off	2 °C	0 ~ 4 °C

- Example : Type0 setting

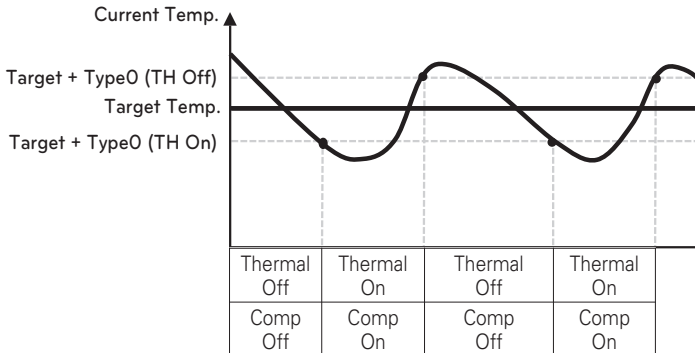

Heating temp. setting

- At the water control in heating mode, the control reference water temperature position setting
- If the air / leaving water temperature selection setting is set to leaving water temperature
- Change setting values using [**<**,**>**(left/right)] button
- The function is not available for some products.

Room Heating		Back	OK
Heating temp. setting		< Outlet >	
Air heating set temp.	>		
Water heating set temp.	>		
Hysteresis Heating Water	>		
Hysteresis Room Air(Heating)	>		

Value	
Outlet (Default)	Inlet

Pump setting in heating

- It is a function to help the water pump's mechanical life by putting the water pump's rest time
- Installer setting function to set water pump on/off interval option during thermo off condition in heating mode.
- In the installer setting list, select Pump setting in heating category, and press [OK] button to move to the detail screen.

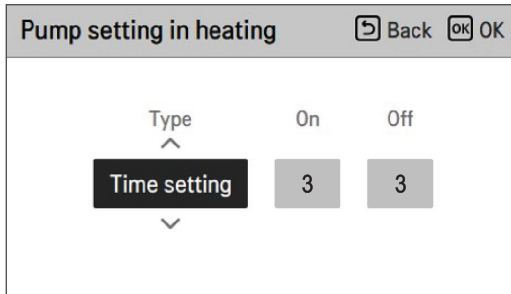
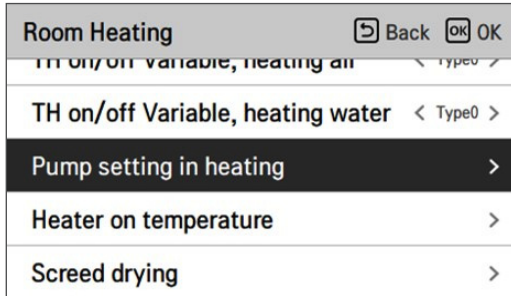

Value	Default	Range
Type	Time setting	Time setting / Continuous Operation
On	3 min	1 ~ 60 min
Off	3 min	1 ~ 60 min

* When Continuous Operation is selected, On, Off is disabled.

Air cooling set temp.

Determine cooling setting temperature range when air temperature is selected as setting temperature.

- In the installer setting list, select Air cooling set temp category, and press [OK] button to move to the detail screen.

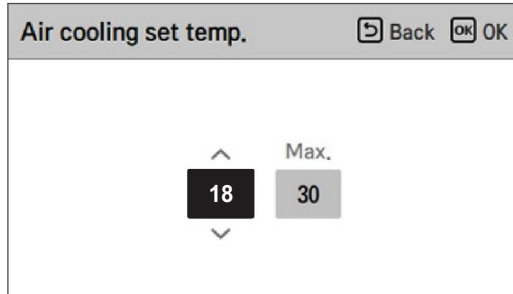
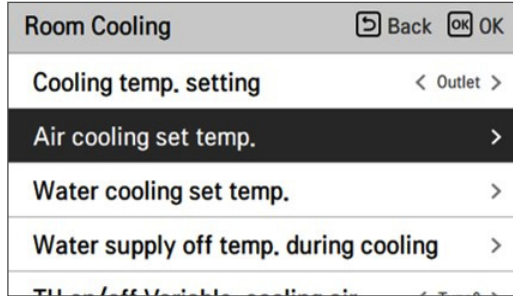

Value	Default	Range
Min.	18 °C	16 ~ 22 °C
Max.	30 °C	24 ~ 30 °C

NOTE

It is possible to control the unit based on room air temperature by using either remote air temperature sensor or wired remote controller (RS3).

- Remote room air sensor is an accessory (PQRSTA0) and sold separately.
- DIP switch setting (No. 5 of Indoor unit Option Switch 2) and installer setting (Select Temperature Sensor) should be set properly in order to use remote room air temperature sensor (PQRSTA0).

Water cooling set temp.

Determine cooling setting temperature range when water temperature is selected as setting temperature.

- In the installer setting list, select water cooling set temp category, and press [OK] button to move to the detail screen.

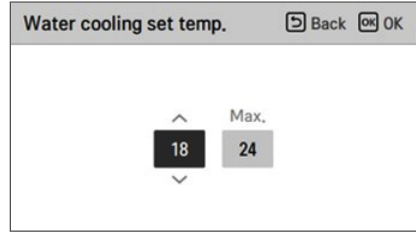
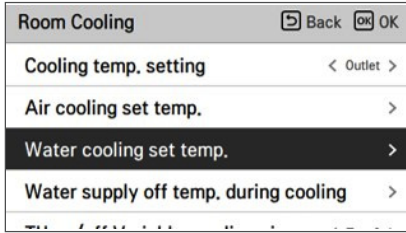

Value	Default	Range	Cooling temp. setting	
Min.	18 °C	5~20 °C	Outlet	FCU use
		16~20 °C		FCU not used
		10~20 °C	Inlet	FCU use
20 °C	20 °C	FCU not used		
Max.	24 °C	22~27 °C	All	

NOTE

Water condensation on the floor

- While cooling operation, it is very important to keep leaving water temperature higher than 16 °C. Otherwise, dew condensation can be occurred on the floor.
- If floor is in humid environment, do not set leaving water temperature below 18 °C.

Water condensation on the radiator

- While cooling operation, cold water may not flow to the radiator. If cold water enters to the radiator, dew generation on the surface of the radiator can be occurred.

Water supply off temp. during cooling

Determine the leaving water temperature which blocks the flow into underfloor coil in cooling mode. This function is used for preventing condensation on the floor in cooling mode

- In the installer setting list, select Water supply off temp. during cooling category, and press [OK] button to move to the detail screen.

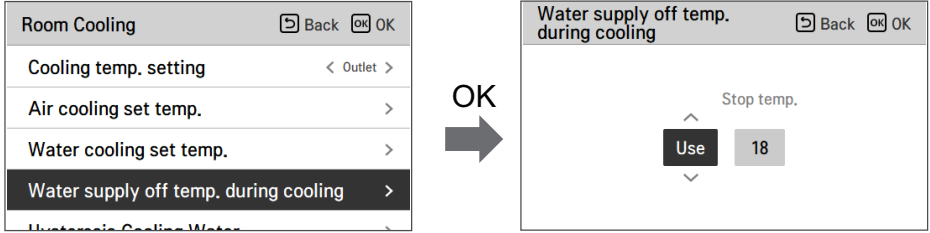

Value	Default	Range
-	Use	Use / Not Use
Stop Temp.	18 °C	16 ~ 25 °C

- Stop temp. : cut-off temp. Stop temp. is valid when FCU is set as 'Use'.
- FCU : determines if FCU is installed or not.
- Example : If FCU is set as 'Use', Stop temp. setting is disabled. However, if actually FCU is NOT installed in the water loop, the unit operates continuously in cooling mode until water temperature meets desired temperature. In this case, a condensed water may form on the floor caused by cold water in the underfloor coil.
- Example : If Stop temp. is set as '20' and FCU is set as 'Not use' and actually FCU is installed in the water loop, then the Stop temp. is used and the unit stops operation in cooling mode when the leaving water temperature is below 20 °C. As a result, the unit may not offer enough cooling since the cold water with desired temperature doesn't flow into the FCU.

! CAUTION

FCU Installation

- If FCU is used, related 2way valve should be installed and connected to the unit PCB.
- If FCU is set as 'Use' whereas FCU or 2way valve is NOT installed, the unit can do abnormal operation.

Hysteresis Room Air(Cooling)

It is a function to adjust the cooling air temperature Thermal On / Off temperature according to the field environment in order to offer optimized cooling operation.

- In the Installer setting list, and select Hysteresis Room Air(Cooling) setting category, and press [OK] button to move to the detail screen.

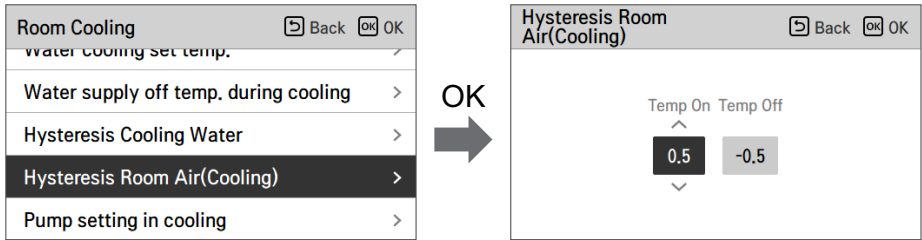

Value	Default	Range
Temp On	0.5 °C	0 ~ 3 °C
Temp Off	-0.5 °C	-3 ~ 0 °C

- Example : Type0 setting

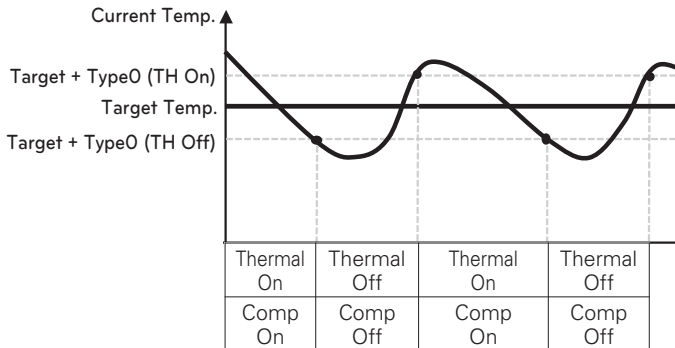

Hysteresis Cooling Water

It is a function to adjust the cooling water temperature Thermal On / Off temperature according to the field environment in order to offer optimized cooling operation.

- In the Installer setting list, and select Hysteresis Cooling Water setting category, and press [OK] button to move to the detail screen.

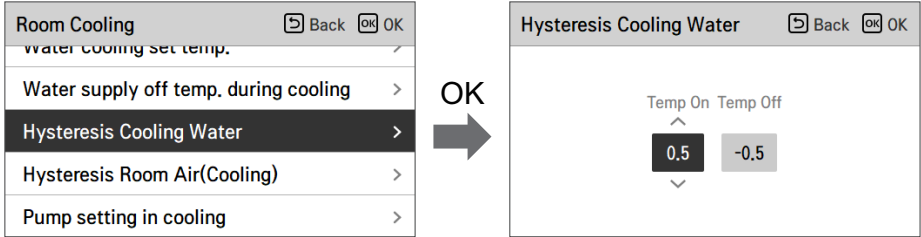

Value	Default	Range
Temp On	0.5 °C	0 ~ 3 °C
Temp Off	-0.5 °C	-3 ~ 0 °C

- Example : Type0 setting

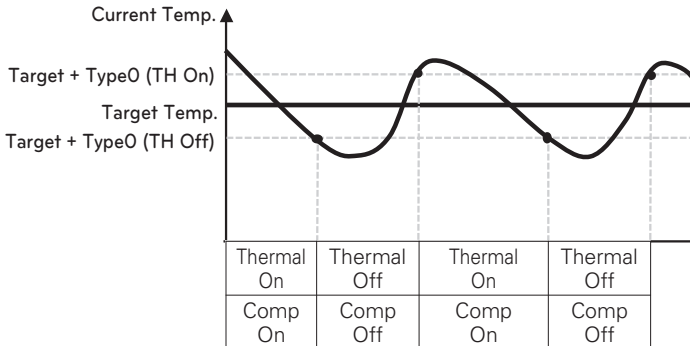

Cooling temp. setting

- At the water control in cooling mode, the control reference water temperature position setting
- If the air / leaving water temperature selection setting is set to leaving water temperature
- Change setting values using [<, > (left/right)] button.
- The function is not available for some products.

Room Cooling		Back	OK
Cooling temp. setting		< Outlet >	
Air cooling set temp.	>		
Water cooling set temp.	>		
Water supply off temp. during cooling	>		
Hysteresis Cooling Water	>		

Value	
Outlet (Default)	Inlet

Pump setting in cooling

- It is a function to help the water pump's mechanical life by putting the water pump's rest time
- Installer setting function to set water pump on/off interval option during thermo off condition in cooling mode.
- In the installer setting list, select Pump setting in cooling category, and press [OK] button to move to the detail screen.

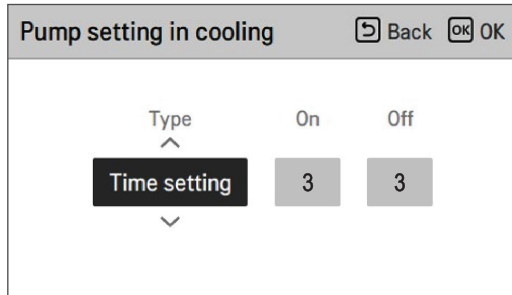
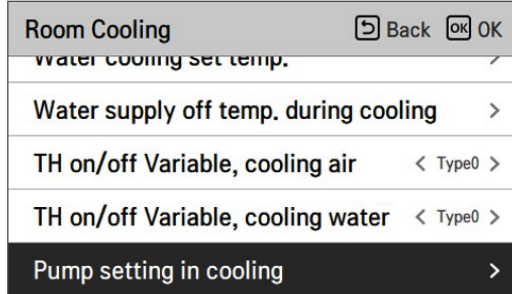

Value	Default	Range
Type	Time setting	Time setting / Continuous Operation
On	3 min	1 ~ 60 min
Off	3 min	1~ 60 min

* When Continuous Operation is selected, On, Off is disabled.

Seasonal auto temp.

It is the function to set the operation reference value in Seasonal Auto mode.

- In the installer setting list, select Seasonal auto temp category, and press [OK] button to move to the detail screen.

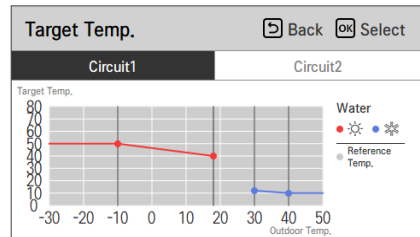
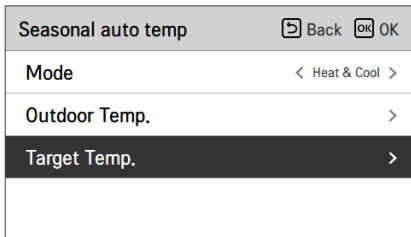
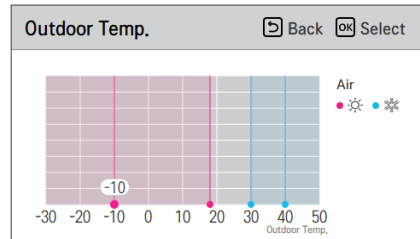
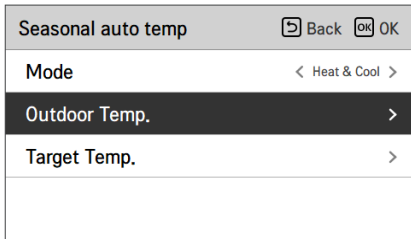
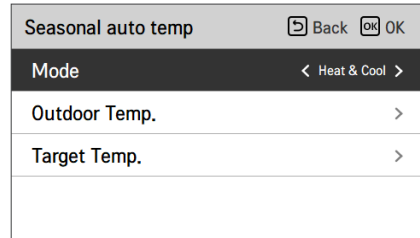
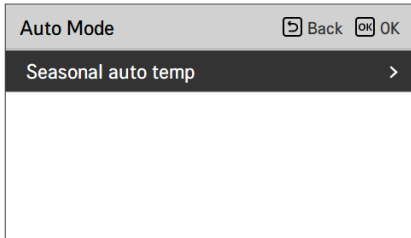

Function	Description	Range	Default (Circuit1)	Default (Circuit2)	Boundary
Outdoor1,Heat (Out1)	Heating lower ambient temp	-25 ~ 35 °C	-10 °C		Out1 ≤ Out2-1
Outdoor2,Heat (Out2)	Heating higher ambient temp		18 °C		Out2 ≥ Out1 +1 Out2 ≤ Out3 -5
Outdoor3,Cool (Out3)	Cooling lower ambient temp	10 ~ 46 °C	30 °C		Out3 ≥ Out2 +5 Out3 ≤ Out4 -1
Outdoor4,Cool (Out4)	Cooling higher ambient temp		40 °C		Out4 ≥ Out3 +1
Water1,Heat (LW1)	Heating higher water temp	Use heater : LW STD : 15~65 °C EW STD : 15~55 °C Not use heater : LW STD : 20~65 °C EW STD : 20~55 °C	50 °C	35 °C	LW1 ≥ LW2
Water 2,Heat (LW2)	Heating lower water temp		40 °C	28 °C	LW1 ≥ LW2
Water3,Cool (LW3)	Cooling higher water temp	Use FCU & 5 °C IDU : LW STD : 5~27 °C EW STD : 10~27 °C Use FCU & 6 °C IDU : LW STD : 6~27 °C EW STD : 11~27 °C Not use FCU : LW STD : 16~27 °C EW STD : 20~27 °C	12 °C	18 °C	LW3 ≥ LW4
Water4,Cool (LW4)	Cooling lower water temp		10 °C	16 °C	LW3 ≥ LW4
Air 1, Heat (RA1)	Heating higher air temp	16 ~ 30 °C	21 °C		RA1 ≥ RA2
Air 2, Heat (RA2)	Heating lower air temp		19 °C		RA1 ≥ RA2
Air 3, Cool (RA3)	Cooling higher air temp	18 ~ 30 °C	21 °C		RA3 ≥ RA4
Air 4, Cool (RA4)	Cooling lower air temp		19 °C		RA3 ≥ RA4

- Setting range: Celsius

- Seasonal Auto Driving mode: Heating, Heating & Cooling

* If heating mode is selected, heating & cooling or cooling can not be selected.

- Depending on the air / outflow control selection value, the water / air related setting value is displayed on the screen.

In this mode, setting temperature will follow outdoor temperature automatically. This mode adds the cooling season function to the conventional weather dependent operation.

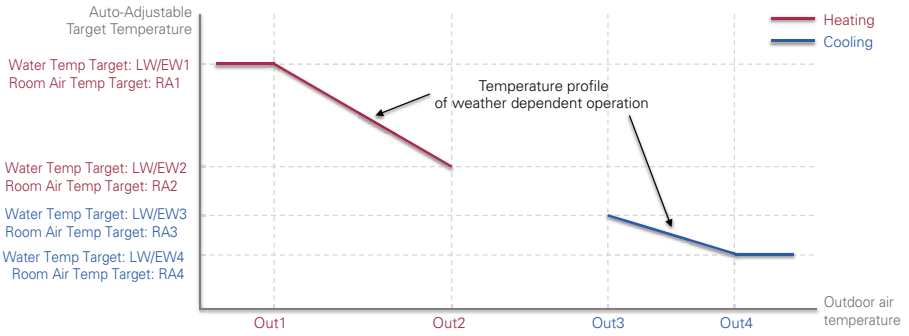

NOTE

DHW mode can be operated independently of seasonal auto temp mode.

Heater priority

- Heater priority: It is decided whether to use the boost heater for DHW operation and the backup heater for floor heating at the same time by condition.
- Example: If the heater priority is set to 'Main+Boost heater ON', the backup heater and boost heater are turned on/off according to the control logic. (It can be turned on at the same time)
If Heater Priority is set to 'Boost heater only ON', the backup heater does not operate when the boost heater operates according to the control logic. (When the boost heater is not in operation, the backup heater operates according to the logic.)
- In the installer setting list, heater priority category, and press [OK] button to move to the detail screen.

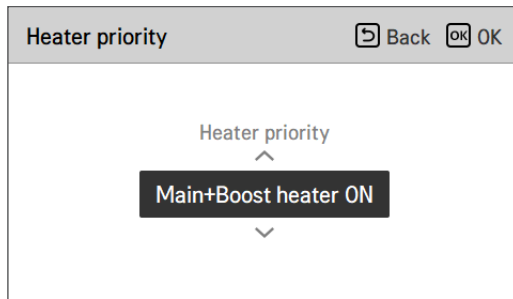
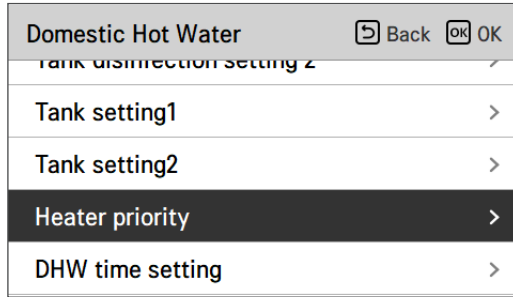

Value	
Boost heater only ON	Main+Boost heater ON (Default)

DHW set temp.

Determine heating setting temperature range when DHW temperature is selected as setting temperature

- In the installer setting list, select DHW set temp. category, and press [OK] button to move to the detail screen.

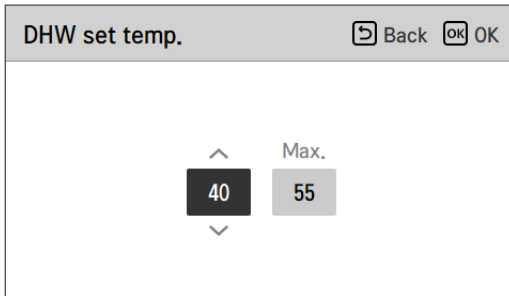
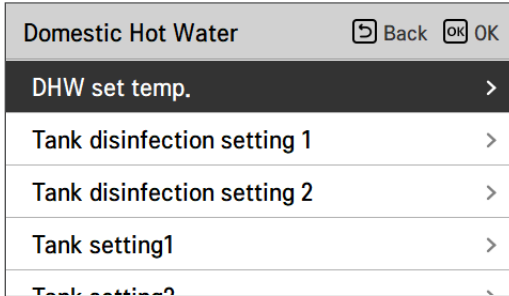

Value	Default	Range
Min.	40 °C	30 ~ 40 °C
Max.	55 °C	50 ~ 80 °C

NOTE

When DHW tank heater(booster heater) is in 'not used' status, Max. temperature will be limited.

Tank disinfection setting 1, 2

- Disinfection operation is special DHW tank operation mode to kill and to prevent growth of legionella inside the tank.
 - Disinfection active : Selecting enable or disable of disinfection operation.
 - Start date : Determining the date when the disinfection mode is running.
 - Start time : Determining the time when the disinfection mode is running.
 - Max temp. : Target temperature of disinfection mode.
 - Duration time : Duration of disinfection mode.

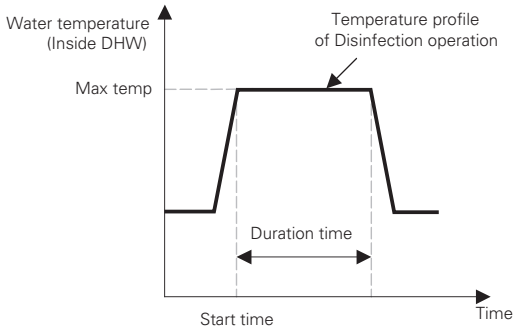

Domestic Hot Water	Back	OK
DHW set temp.	>	
Tank disinfection setting 1	>	
Tank disinfection setting 2	>	
Tank setting1	>	
Tank setting2	>	

OK



Tank disinfection setting 1	Back	OK
Disinfection active	Start date	Start time
Not use	Fri.	23

Domestic Hot Water	Back	OK
DHW set temp.	>	
Tank disinfection setting 1	>	
Tank disinfection setting 2	>	
Tank setting1	>	
Tank setting2	>	

OK



Tank disinfection setting 2	Back	OK
Max temp.	Duration time	Forced end time
70	10	1

NOTE

DHW heating should be enable

- If Disinfection active is set as 'Not use', that is 'disable disinfection mode', Start date and Start time is not used.

Tank setting1

- In the installer setting list, select tank setting 1 category, and press [OK] button to move to the detail screen.

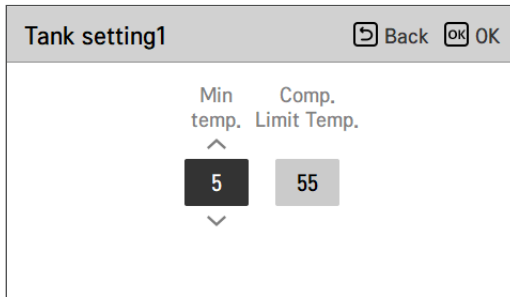
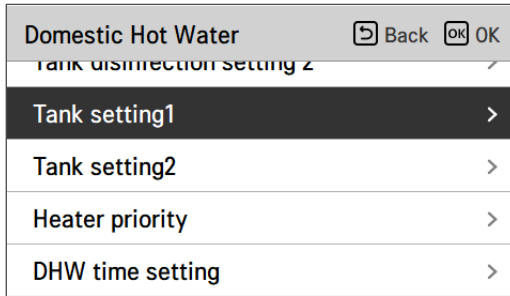

Value	Default	Range
Min. temp.	5 °C	1 ~ 30 °C
Comp. Limit Temp.	55 °C	40 ~ 58 °C

NOTE

"Max outdoor temp." means rising Max temp. by heat pump cycle. Above this temp., only electric heater will be used.

Tank setting2

- In the installer setting list, select tank setting 2 category, and press [OK] button to move to the detail screen.

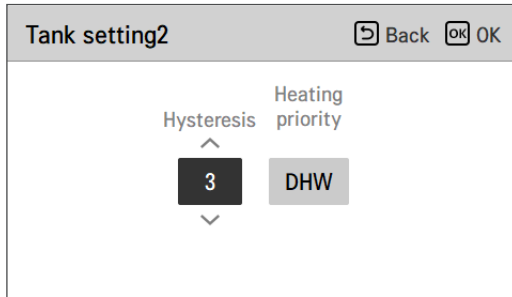
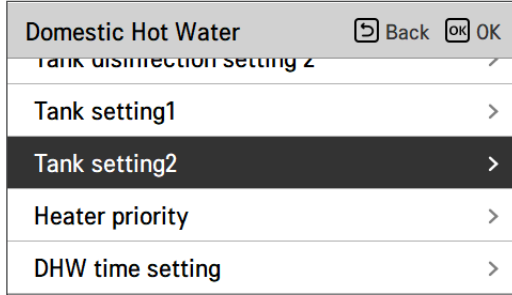

Value	Default	Range
Hysteresis	3 °C	2 ~ 4 °C
Heating priority	DHW	Floor heating / DHW

• **Tank setting 1, 2**

Descriptions for each parameters are as following.

- Min temp. : temperature gap from Max outdoor temp.
- Max outdoor temp. : maximum temperature generated by AWHP compressor cycle.
- Example : If Min temp. is set as '5' and Max outdoor temp. is set as '48', then Session A (see the graph) will be started when the water tank temperature is below 43 °C.... If temperature is above 48 °C..., then Session B will be started.

- Hysteresis : Temperature gap from target DHW temperature for booster heater operating. This value is required to prevent frequent On and Off of water tank heater. In the normal DHW operation, the value is set as '0' and Hysteresis is valid when heater delay time is active.
- Example : If user's target temperature is set as '70' and Hysteresis is set as '3', then the booster heater will be turned off when the water temperature is above 73 °C. The booster heater will be turned on when the water temperature is below 70 °C.
- Heating priority : Determining heating demand priority between DHW tank heating and under floor heating.
- Example : If Heating priority is set as 'DHW', that means heating priority is on DHW heating, DHW is heated by AWHP compressor cycle and booster heater. In this case the under floor can not be heated while DHW heating. On the other hand, if the Heating priority is set as 'Floor heating', that means heating priority is on under floor heating, DHW tank is ONLY heated by booster heater. In this case the under floor heating is not stopped while DHW is heated.

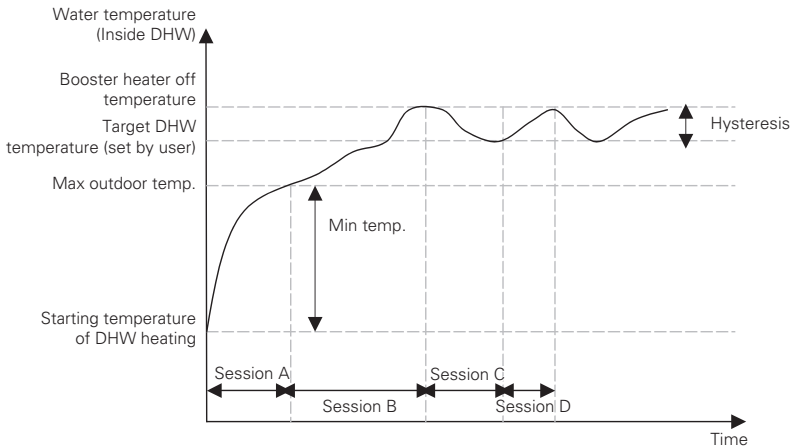

- Session A : Heating by AWHP compressor cycle and booster heater
- Session B : Heating by booster heater
- Session C : No heating (booster heater is Off)
- Session D : Heating by booster heater

NOTE

DHW heating does not operate when it is disabled.

DHW time setting

Determine following time duration : operation time of DHW tank heating, stop time of DHW tank heating, and delay time of DHW tank heater operating.

- Active time : This time duration defines how long time DHW tank heating can be continued.
- Stop time : This time duration defines how long time DHW tank heating can be stopped. It is also regarded as time gap between DHW tank heating cycle.
- Boost heater delay time : This time duration defines how long time DHW tank heater will not be turned on in DHW heating operation.
- Example of timing chart :

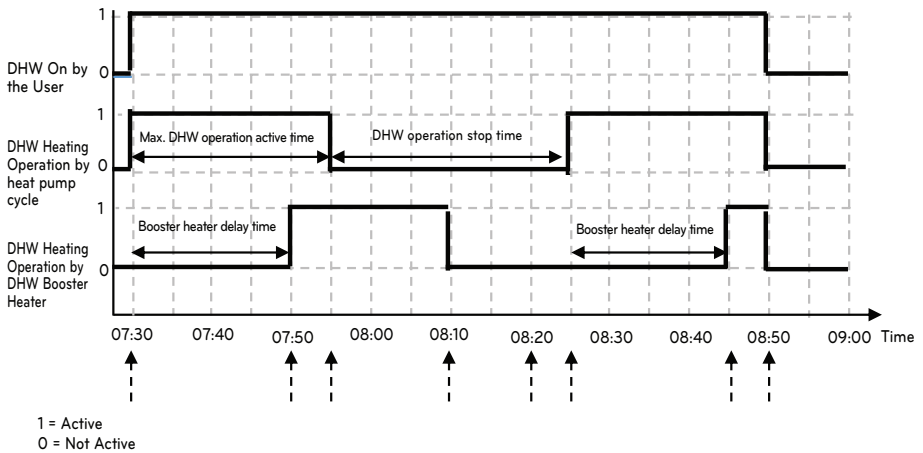

Time	Description
7:30	The user activates the DHW function in the remote controller (DHW operation starts by the heat pump cycle as the Thermo on condition is reached)
7:50	The booster heater is activated after the booster heater delay time(20 min)
7:55	The active time(25min) of DHW operation by the heat pump cycle ends and the heat pump cycle is forced to be stopped (The booster heater is continues to operate because the target temperature is not reached)
8:10	The booster heater operation ends as the target temperature is reached
8:20	DHW operation is not activated by the stop time(30 min) even though the water temperature is dropped and DHW operation condition is reached.
8:25	When the active time condition is reached, DHW operation starts again by the heat pump cycle
8:45	The booster heater is activated after the booster heater delay time(20 min)
8:50	The user deactivates the DHW function by turning it off in the remote controller

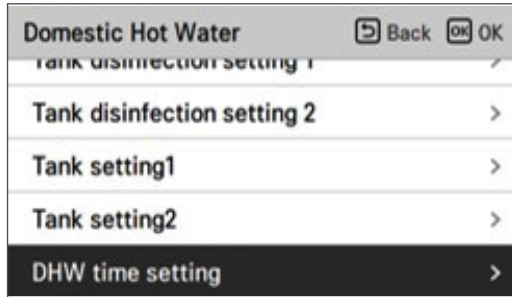

Value	Default	Range
Active time	30 min	5~95 min
Stop time	30 min	0~600 min

Recirculation time

- It is function to set recirculation water pump on/off interval option
- In the installer setting list, select Recirculation time category, and press [OK] button to move to the detail screen.

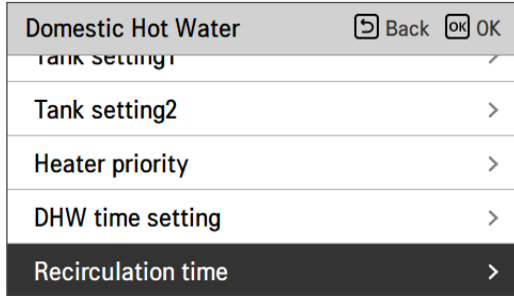

Value	Default	Range
DHW recirculation	Not use	Use / Not use
ON Time	10 min	1 ~ 60 min
OFF Time	20 min	1 ~ 60 min

Solar Thermal System

It is function to set operation reference value in Solar Thermal System.

In the installer setting list, select Solar thermal system category, and press [OK] button to move to the detail screen.

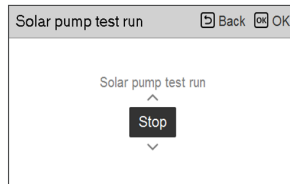
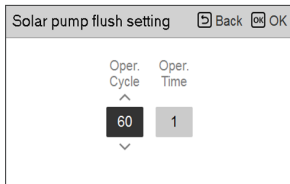
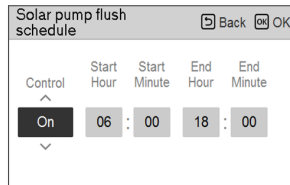
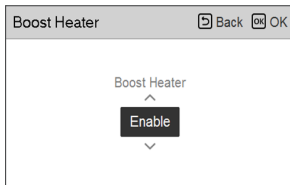
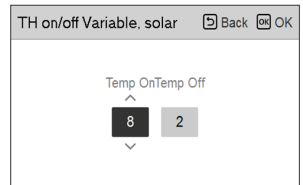
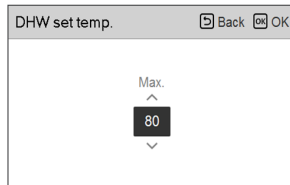
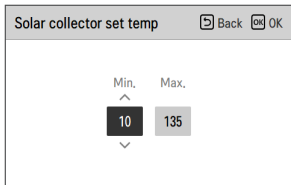
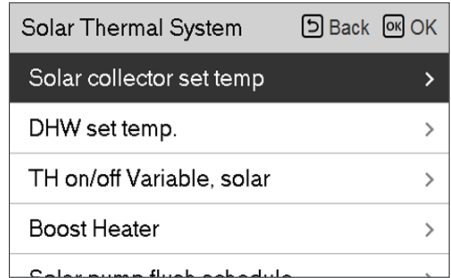
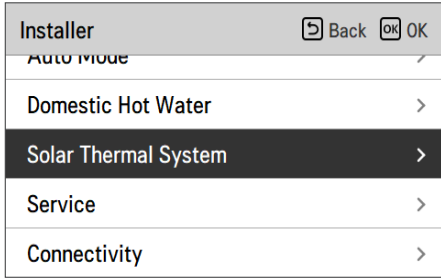

NOTE

To use this function, switch No.2 of option switch 2 must be turned ON and No.3 of option switch 2 must be turned OFF.

Descriptions for each parameters are as following.

- Solar collector set temp
 - Min temp : It is the minimum solar collector temperature at which the solar thermal system can operate.
 - Max temp : It is the maximum solar collector temperature at which the solar thermal system can operate.
- TH on/off Variable, solar
 - Temp on : It is the temperature difference between the current solar thermal temperature and DHW tank temperature at which the solar thermal system operates.
 - Temp off : It is the temperature difference between the current solar thermal temperature and DHW tank temperature at which the solar thermal system stops.
 - Example : If the current solar collector temperature is 80 °C and Temp on is set to 8 °C, the solar thermal system operates when the DHW tank temperature is less than 72 °C. In the same case, if Temp off is set to 2 °C, Solar Thermal System stops when DHW temperature is 78 °C.
- DHW Set Temp
 - Max : It is maximum temperature of DHW that can be reached by solar thermal system.
- Boost Heater
 - Enable : Booster heater can be used when operating the Solar Thermal system.
 - Disable : Booster heater cannot be used when operating the Solar Thermal system.
- Solar pump flush schedule
 - It is the function to circulate the solar water pump intermittently for solar collector temperature detection when the solar water pump does not operate for a long time. Turn on to use this function.
- Solar Pump flush setting
 - Oper.Cycle : When using the solar pump flush function, the solar water pump operates at the set time.
 - Oper.Time : When using the solar pump flush function, the solar water pump operates during the set time.

Function	Value	Range	Default
Solar collector set temp	Min	5 °C ~ 50 °C	10 °C
	Max	60 °C ~ 200 °C	95 °C
DHW set temp	Max	20 °C ~ 90 °C	80 °C
TH on/off Variable, solar	Temp On	3 °C ~ 40 °C	8 °C
	Temp Off	1 °C ~ 20 °C	2 °C
Boost Heater	Boost Heater	Enable/Disable	Enable
Solar pump flush schedule	On/OFF	On/Off	On
	Start Hour, Start Minute	00:00 ~ 24:00	6:00
	End Hour, End Minute	00:00 ~ 24:00	18:00
Solar pump test run	Pump test Run	Start/Stop	Stop
Solar pump flush setting	Oper.Cycle	30 min ~ 120 min	60 min
	Oper.Time	1 min ~ 10 min	1 min

Pump test run

The pump test run is to test run by operating the water pump for 1 hour.

This function can be used for air purging through air vents and checking flow rate and others.

- In the installer setting list, Pump Test run category, and press [OK] button to move to the detail screen.

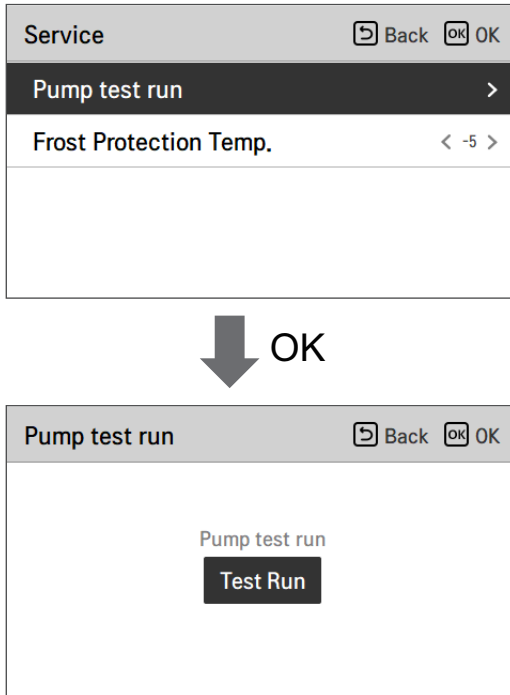

NOTE

The setting for thermostat and dry contact should be disabled to use the Pump test run function.

Frost Protection Temp.

This function prevents the unit from freezing. This function sets the freeze protection temperature according to the concentration injected after injecting antifreeze. Make sure to use this function only when antifreeze is added.

- Change setting values using [- The function is not available for some products.

Service	⏪ Back	OK ⏩
Pump test run	>	
Frost Protection Temp.	< -5 >	

Default	Range
-5 °C	-25 ~ -5 °C

NOTE

To use this function, the antifreeze short pin(CN_ANTI_SW) must be open and switch No.8 in Option SW 1 must be on.

Antifreeze short pin

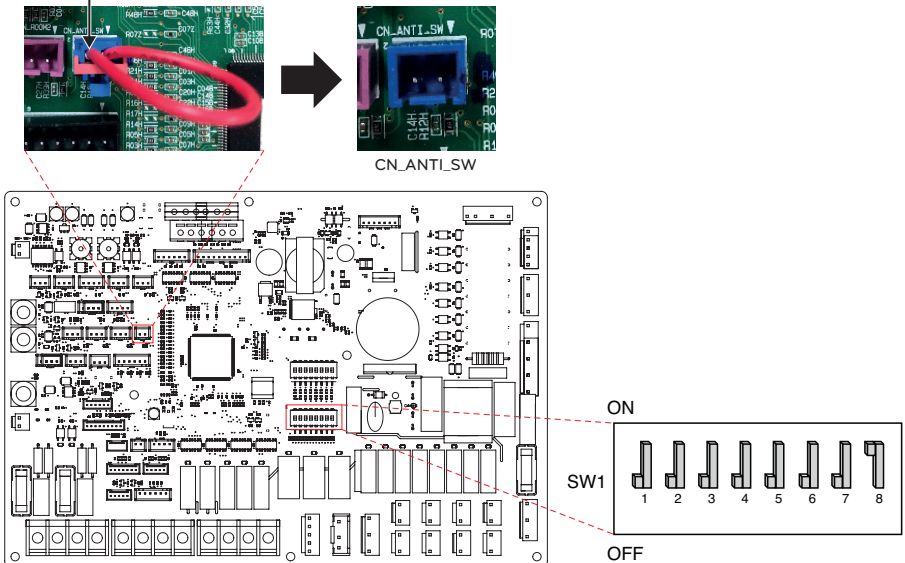

Dry Contact Mode

Dry contact function is the function that can be used only when the dry contact devices is separately purchased and installed.

- Change setting values using [<,>(left/right)] button.

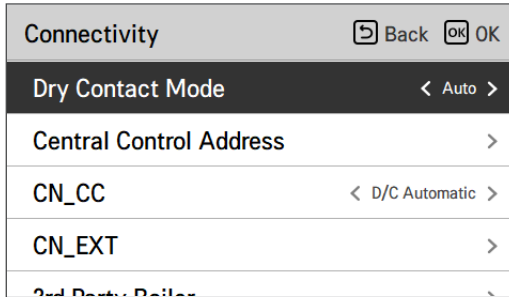

Value	Description
Auto (Default)	Automatically operation ON with release hard lock
Manual	Keep operation OFF with hard lock

NOTE

For dry contact mode related detail functions, refer to the individual dry contact manual.

What is dry contact?

It means the contact point signal input when the hotel card key, human body detection sensor, etc. are interfacing with the unit.

Added system functionality by using external inputs (dry contacts and wet contacts).

Central Control Address

When connecting the central control, set the central control address of the unit.

- In the installer setting list, select Central Control Address category, and press [OK] button to move to the detail screen.

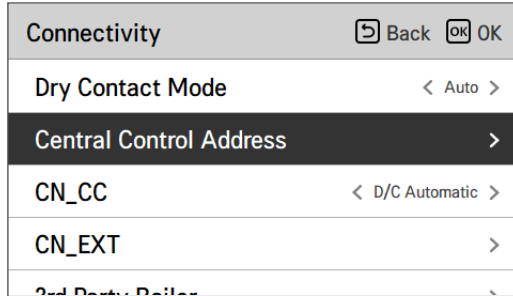

NOTE

- Enter address code as hexadecimal value
- Front: Central Control Gr. No.
- Back side: Central control indoor the number

CN_CC

It is the function to set the usage of the unit's CN_CC port.

- Change setting values using [<,>(left/right)] button

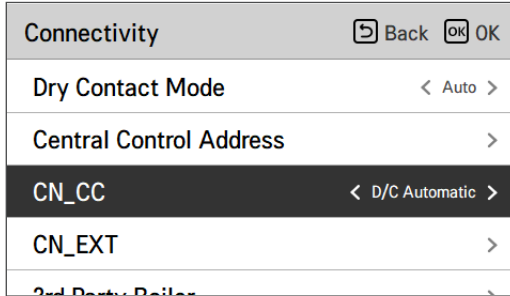

Value	Description
D/C Automatic (Default)	When power is applied to the product, the unit when the contact point is on in Dry Contact installed state recognizes Dry Contact installation
D/C Not Installed	Do not use (install) Dry Contact
D/C Installed	Use (install) Dry Contact

NOTE

CN_CC is the device connected to the unit to recognize and control the external contact point.

LG Therma V Configuration

This function can be set to save the environment settings of the product for use in LG Therma V Configurator through SD Card.

- In the Installer setting list, and select LG Therma V Configuration setting category, and press [OK] button to move to the detail screen.

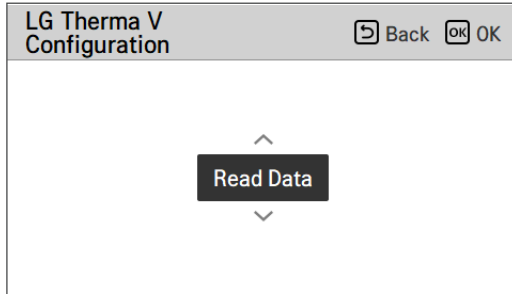
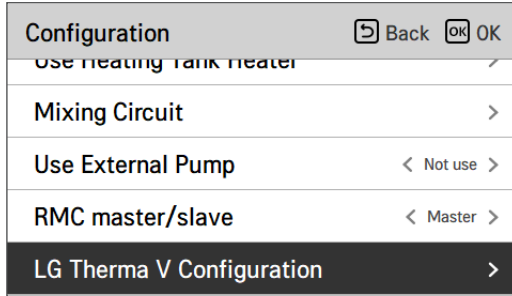

Value	
Read Data	Save Data

Energy state

This function is to control the product according to the energy state. When the charged state of ESS is transmitted, it changes the target temperature of heating, cooling and DHW by setting value according to energy state.

Select either Signal Mode or Modbus Mode according to the connection type between the product and the ESS.

Installer	Back OK
IDU operation time	>
RMC master/slave	< Master >
Energy state	>
Data logging	>
Password Initialization	>



Energy state	Back OK
ESS use type	< Not use >
Energy state definition	>
Digital input assignment	>

Value	Default
Not Use	Not use
Use Modbus	
Use Digital Input	
ThinQ	

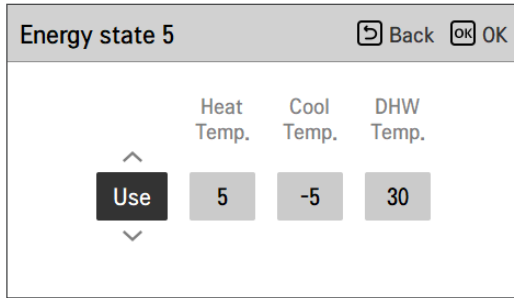
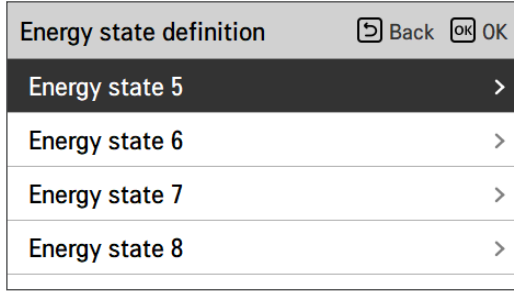

Division	Value	Default	Range	Division	Value	Default	Range
ES 1	-	Use	Use / Not Use	ES 5	-	Use	Use / Not Use
	Heat Temp.	Off	fixed		Heat Temp.	+5 °C	0 ~ 30 °C
	Cool Temp.	Off	fixed		Cool Temp.	-5 °C	-30 ~ 0 °C
	DHW Temp.	Off	fixed		DHW Temp.	+30 °C	0 ~ 50 °C
ES 2	-	Use	Use / Not Use	ES 6	-	Use	Use / Not Use
	Heat Temp.	Normal	fixed		Heat Temp.	+2 °C	0 ~ 30 °C
	Cool Temp.	Normal	fixed		Cool Temp.	-2 °C	-30 ~ 0 °C
	DHW Temp.	Normal	fixed		DHW Temp.	+10 °C	0 ~ 50 °C
ES 3	-	Use	Use / Not Use	ES 7	-	Use	Use / Not Use
	Heat Temp.	+2 °C	fixed		Heat Temp.	-2 °C	-30 ~ 0 °C
	Cool Temp.	0 °C	fixed		Cool Temp.	+2 °C	0 ~ 30 °C
	DHW Temp.	+5 °C	fixed		DHW Temp.	0 °C	-50 ~ 0 °C
ES 4	-	Use	Use / Not Use	ES 8	-	Use	Use / Not Use
	Heat Temp.	0 °C	fixed		Heat Temp.	-5 °C	-30 ~ 0 °C
	Cool Temp.	0 °C	fixed		Cool Temp.	+5 °C	0 ~ 30 °C
	DHW Temp.	80 °C	fixed		DHW Temp.	0 °C	-50 ~ 0 °C

* ES = Energy state

* ES 4 DHW Temp. 80 °C is the desired temperature value, not the offset.

When Signal Mode of EES use type is selected, press the Digital Input Assignment button to set the energy state according to the input signal.

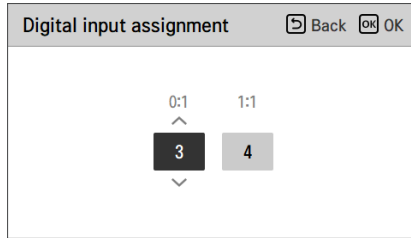

Value	Input Signal		Output state	
	TB_SG1	TB_SG2	Default	Range
X	0	0	ES2	fixed
X	1	0	ES1	fixed
0:1	0	1	ES3	ES3-ES8
1:1	1	1	ES4	

Thermostat control type

Set the type of thermostat control.

- In the Installer setting list, and select Connectivity category, and press [OK] button to move to the detail screen.

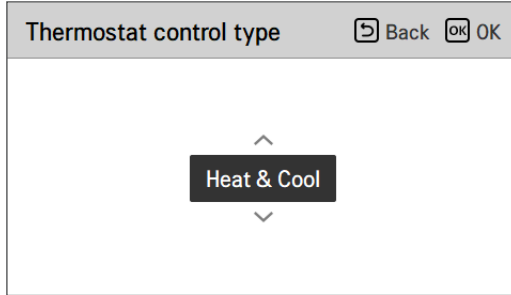
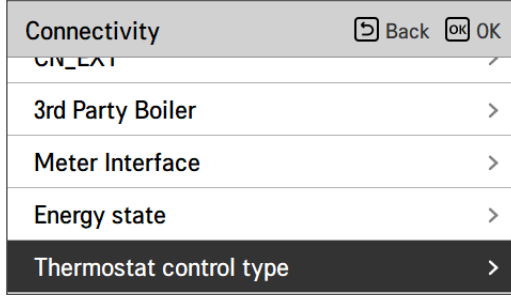

Type	
Heat & Cool (Default)	Heat & Cool / DHW

Pump operation time

It is a function to show the water pump's operation time for check mechanical life.

- In the Installer setting list, and select Information category, and press [OK] button to move to the detail screen.

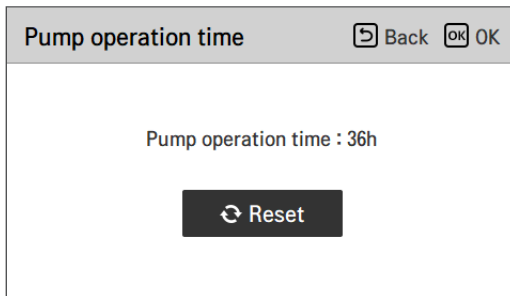
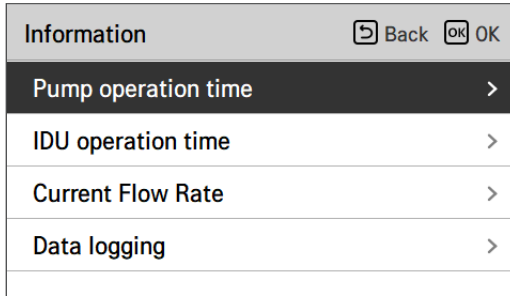

IDU operation time

It is a function to show the Indoor Unit's operation time for check mechanical life.

- In the Installer setting list, and select Information category, and press [OK] button to move to the detail screen.

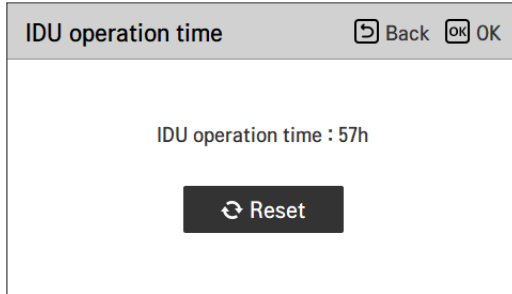
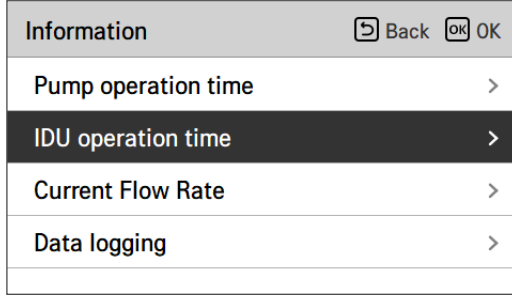

Modbus Address

It is function to set the address of the Modbus device that is externally linked to the product. Modbus address setting function is available from indoor unit.

- In the installer setting list, select Modbus Address , and press [OK] button to move to the detail screen.

Connectivity		Back	OK
Central Control Address	>		
CN_CC	< D/C Automatic >		
Modbus Address	>		
CN_EXT	>		
3rd Party Boiler	>		



Modbus Address		Back	OK
Address Code(Hex)			
^			
0	1		
v			

NOTE

To use this function, switch No.1 of option switch 1 must be turned ON.

Modbus gateway memory map

Baud Rate : 9 600 bps Stop Bit : 1 stop bit Parity : None Parity

Coil Register (0x01)

Register	Description	Value explanation
00001	Enable/Disable (Heating/Cooling)	0 : Operation OFF / 1 : Operation ON
00002	Enable/Disable (DHW)	0 : Operation OFF / 1 : Operation ON
00003	Silent Mode Set	0 : Silent mode OFF / 1 : Silent mode ON
00004	Trigger Disinfection operation	0 : Keep status / 1 : Operation start
00005	Emergency Stop	0 : Normal operation / 1 : Emergency stop
00006	Trigger Emergency Operation	0 : Keep status / 1 : Operation Start

Discrete Register (0x02)

Register	Description	Value explanation
10001	Water flow status	0 : Flow rate ok / 1 : Flow rate too low
10002	Water Pump status	0 : Water Pump OFF / 1 : Water Pump ON
10003	Ext. Water Pump status	0 : Water Pump OFF / 1 : Water Pump ON
10004	Compressor status	0 : Compressor OFF / 1 : Compressor ON
10005	Defrosting status	0 : Defrost OFF / 1 : Defrost ON
10006	DHW heating status (DHW Thermal On/Off)	0 : DHW inactive / 1 : DHW active
10007	DHW Tank disinfection status	0 : Disinfection inactive / 1 : Disinfection active
10008	Silent mode status	0 : Silent mode inactive / 1 : Silent mode active
10009	Cooling status	0 : No cooling / 1 : Cooling operation
10010	Solar pump status	0 : Solar pump OFF / 1 : Solar pump ON
10011	Backup heater (Step 1) status	0 : OFF / 1 : ON
10012	Backup heater (Step 2) status	0 : OFF / 1 : ON
10013	DHW boost heater status	0 : OFF / 1 : ON
10014	Error status	0 : no error / 1 : error state
10015	Emergency Operation Available (Space heating/cooling)	0 : Unavailable / 1 : Available
10016	Emergency Operation Available (DHW)	0 : Unavailable / 1 : Available
10017	Mix pump status	0 : Mix pump OFF / 1 : Mix pump ON

Holding Register (0x03)

Register	Description	Value explanation
40001	Operation Mode	0 : Cooling / 4 : Heating / 3 : Auto
40002	Control method (Circuit 1/2)	0 : Water outlet temp. control 1 : Water inlet temp. control 2 : Room air control
40003	Target temp (Heating/Cooling) Circuit 1	[0.1 °C ×10]
40004	Room Air Temp. Circuit 1	[0.1 °C ×10]
40005	Shift value(Target) in auto mode Circuit 1	1K
40006	Target temp (Heating/Cooling) Circuit 2	[0.1 °C ×10]
40007	Room Air Temp. Circuit 2	[0.1 °C ×10]
40008	Shift value(Target) in auto mode Circuit 2	1K
40009	DHW Target temp.	[0.1 °C ×10]
40010	Energy state input	0 : Not Use 1 : Forced off (equal to TB_SG1=close / TB_SG2=open) 2 : Normal operation (equal to TB_SG1=open / TB_SG2=open) 3 : On-recommendation (equal to TB_SG1=open / TB_SG2=close) 4 : On-command (equal to TB_SG1=close / TB_SG2=close) 5 : On-command step 2 (++ Energy Consumption compared to Normal) 6 : On-recommendation Step 1 (+ Energy Consumption compared to Normal) 7 : Energy Saving mode (- Energy Consumption compared to Normal) 8 : Super Energy saving mode (– Energy Consumption compared to Normal)

Input Register (0x04)

Register	Description	Value explanation
30001	Error Code	Error Code
30002	ODU operation Cycle	0 : Standby(OFF) / 1 : Cooling / 2 : Heating
30003	Water inlet temp.	[0.1 °C ×10]
30004	Water outlet temp.	[0.1 °C ×10]
30005	Backup heater outlet temp.	[0.1 °C ×10]
30006	DHW tank water temp.	[0.1 °C ×10]
30007	Solar collector temp.	[0.1 °C ×10]
30008	Room air temp. (Circuit 1)	[0.1 °C ×10]
30009	Current Flow rate	[0.1 LPM ×10]
30010	Flow temp. (Circuit 2)	[0.1 °C ×10]
30011	Room air temp. (Circuit 2)	[0.1 °C ×10]
30012	Energy State input	0 : Energy state 0; 1: Energy state 1....
30013	Outdoor Air temp.	[0.1 °C ×10]
39998	Product Group	0x8X (0x80, 0x83, 0x88, 0x89)
39999	Product Info.	Split : 0 / Monobloc : 3 / High Temp. : 4 / Medium Temp. : 5 / System Boiler : 6

CN_EXT

It is a function to control external input and output according to DI type set by customer using CN-EXT Port.

- In the installer setting list, select CN-EXT Port category, and press [OK] button to move to the detail screen.

The screenshot shows a menu titled "Connectivity" with a "Back" button and an "OK" button. The menu items are: "Dry Contact Mode" (set to "Auto"), "Central Control Address", "CN_CC" (set to "D/C Automatic"), and "CN_EXT" (highlighted with a right arrow). Below "CN_EXT", the start of another menu item "2nd Party Boiler" is visible.



The screenshot shows the "CN_EXT" detail screen with a "Back" button and an "OK" button. It displays four selectable options in a 2x2 grid: "Not use" (highlighted), "Simple Operation", "Simple Dry Contact", and "Single emergency stop".

Value	Contact Input	Operation	Remark
Not Use	Open	-	-
	Close	-	-
Simple Operation	Open	OFF	-
	Close	ON	-
Simple Dry Contact	Open	OFF + Hard Lock	Follows Dry Contact mode : - Auto mode : if contact input closes, operation On - Manual mode : if contact input closes, keep in previous state - Hard lock: Unable to control the product
	Close	ON	
Single emergency stop	Open	Always OFF	Priority : - Emergency stop Lock > Central control Lock > Dry Lock
	Close	Emergency stop released	

3rd Party Boiler

This function is to configure the 3rd party boiler to be controlled.

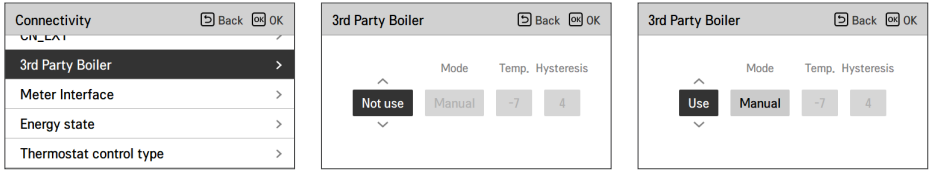

If the status of this function is "Use", you can choose control mode of boiler, Auto or Manual.

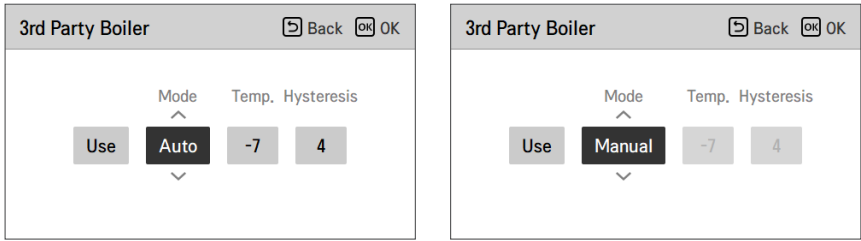

If the mode of this function is set to "Auto", you can set temperature of the boiler and hysteresis, respectively.

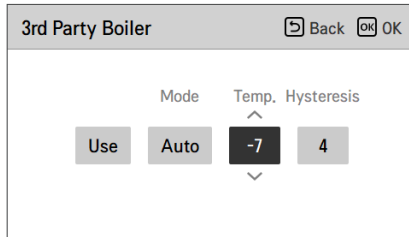

External boiler ON condition :

- If outdoor temperature \leq external boiler operation temperature value (installer setting), turn off the indoor unit and operate the external boiler.

External boiler OFF condition :

- If External air temperature \geq external boiler operation temperature value (installer setting) + Hysteresis (installer setting), turn off external boiler operation and operate indoor unit

Meter Interface

It is the function that can check the status of energy and power on screen. It collects and calculates power or calorie data to create data for energy monitoring and energy warning alarm pop-ups. This function can be activated in installer mode.

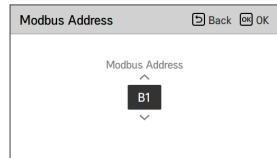
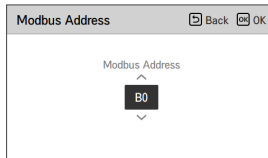
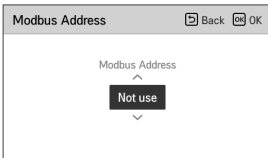
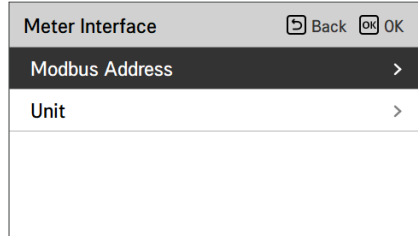
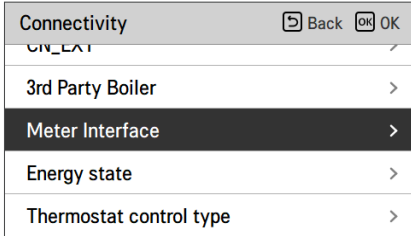

There are 2 options, modbus address and unit, in this function. Activating the modbus address option, you choose one address(B0 or B1) or don't use. Then, you set the port and specification in range of 0000.0~9999.9[pulse/kWh] as shown in the figure below.

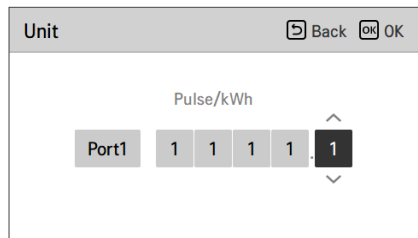
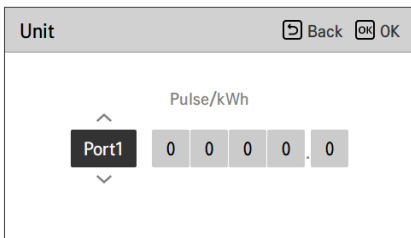

Current flow rate

It is the function to check the current flow rate.

- In the installer setting list, select Current Flow Rate category, and press [OK] button to move to the detail screen. The current flow rate can be checked. (Range : 7 ~ 80 L/min)
- The function is not available for some products.

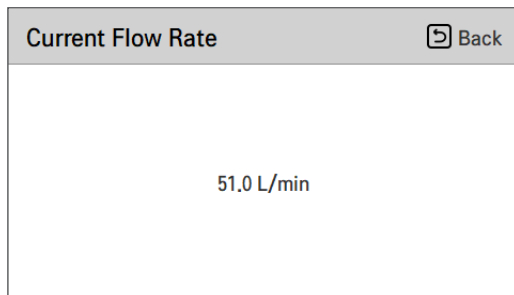
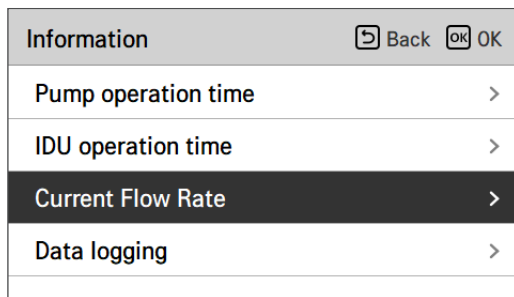

Data logging

This function is to check the operation and error history.

- In the installer setting list, select Data logging category, and press [OK] button to move to the detail screen.

Information		Back	OK
Pump operation time	>		
IDU operation time	>		
Current Flow Rate	>		
Data logging	>		



Data logging					Back
Date	Time	Oper.	Settemp	In/Out	
2020.07.02	03:01	Cool	16°	25° / 25°	
2020.07.02	02:57	Cool	16°	25° / 25°	
2020.07.02	02:31	Cool	16°	25° / 25°	>
2020.07.02	02:27	Cool	16°	25° / 25°	
2020.07.02	02:01	Cool	16°	25° / 25°	

NOTE

Error history lookup range: 50

Error history information

Item: date, time, mode (including Off), set temperature, incoming temperature, outgoing temperature, room temperature, Hot water operation / stop, Hot water set temperature, Hot water temperature, Outdoor unit On / Off, Error code

Number of Display: Within 50

- Save criteria ∨

∨ Error occurred, released ON / OFF of outdoor unit operation.

COMMISSIONING

If everything is going well until now, it is time to start the operation and to take advantages of **THERMAV.**

Before starting operation, pre-check points are described in this chapter. Some comments about maintenance and how to do troubleshooting are presented.

Check List before Starting Operation

CAUTION

Turn off the power before changing wiring or handling product

No	Category	Item	Check Point
1	Electricity	Field wiring	<ul style="list-style-type: none"> All switches having contacts for different poles should be wired tightly according to regional or national legislation. Only qualified person can proceed wiring. Wiring and local-supplied electric parts should be complied with European and regional regulations. Wiring should be following the wiring diagram supplied with the product.
2		Protective devices	<ul style="list-style-type: none"> Install ELB (earth leakage breaker) with 30 mA. ELB inside the control box of the unit should be turned on before starting operation.
3		Earth wiring	<ul style="list-style-type: none"> Earth should be connected. Do not earth to gas or city water pipe, metallic section of a building, surge absorber, etc.
4		Power supply	<ul style="list-style-type: none"> Use dedicated power line.
5		Terminal block wiring	<ul style="list-style-type: none"> Connections on the terminal block (inside the control box of the unit) should be tightened.
6	Water	Charged water pressure	<ul style="list-style-type: none"> After water charging, the pressure gauge (in front of the unit) should indicate 2.0~2.5 bar. Do not exceed 3.0 bar.
7		Air purge	<ul style="list-style-type: none"> During water charging, air should be taken out through the hole of the air purge. If water does not splash out when the tip (at the top of the hole) is pressed, then air purging is not completed yet. If well purged, the water will splash out like fountain. Be careful when testing air purge. Splashed water may make your dress wet.
8		Shut-off valve	<ul style="list-style-type: none"> Two shut-off valves (located at the end of water inlet pipe and water outlet pipe of the unit) should be open.
9		By-pass valve	<ul style="list-style-type: none"> By-pass valve should be installed and adjusted to secure enough water flow rate. If water flow rate is low, flow switch error (CH14) can be occurred.
10	Product Installation	Hang to the wall	<ul style="list-style-type: none"> As the unit is hung on the wall, vibration or noise can be heard if the unit is not fixed tightly. If the unit is not fixed tightly, it can fall down during operation.
11		Parts inspection	<ul style="list-style-type: none"> There should be no apparently damaged parts inside the unit.
12		Refrigerant leakage	<ul style="list-style-type: none"> Refrigerant leakage degrades the performance. If leakage found, contact qualified LG air conditioning installation person.
13		Drainage treatment	<ul style="list-style-type: none"> While cooling operation, condensed dew can drop down to the bottom of the unit. In this case, prepare drainage treatment (for example, vessel to contain condensed dew) to avoid water drop.

To assure best performance of **THERMAV**®, it is required to perform periodical check and maintenance. It is recommended to proceed following check list for once a year.

CAUTION

Turn off the power before proceeding maintenance

No	Category	Item	Check Point
1	Water	Water pressure	<ul style="list-style-type: none"> • In normal state, the pressure gauge (in front of the unit) should indicate 2.0~2.5 bar. • If the pressure is less than 0.3 bar, please recharge the water.
2		Strainer (Water filter)	<ul style="list-style-type: none"> • Close the shut-off valves and disassemble strainer. Then wash the strainer to make it clean. • While disassembling the strainer, be careful for water flood out.
3		Safety valve	<ul style="list-style-type: none"> • Open the switch of the safety valve and check if water is flood out through the drain hose. • After checking, close the safety valve.
4	Electricity	Terminal block wiring	<ul style="list-style-type: none"> • Look and inspect if there is loosen or defected connection on the terminal block.

Starting Operation

Check before Starting Operation

1	Check to see whether there is any refrigerant leakage, and check whether the power or transmission cable is connected properly.
2	<p>Confirm that 500 V megger shows 2.0 MΩ or more between power supply terminal block and ground. Do not operate in the case of 2.0 MΩ or less.</p> <p>NOTE: Never carry out mega ohm check over terminal control board. Otherwise the control board may break.</p> <p>Immediately after mounting the unit or after leaving it turned off for an extended length of time, the resistance of the insulation between the power supply terminal board and the ground may decrease to approx. 2.0 MΩ as a result of refrigerant accumulation in the internal compressor.</p> <p>If the insulation resistance is less than 2.0 MΩ, turn on the main power supply.</p>
3	When the power is applied for the first time, operate the product after preheating for 2 hours. To protect the unit by increasing the oil temperature of the compressor.

Starting Operation flow chart

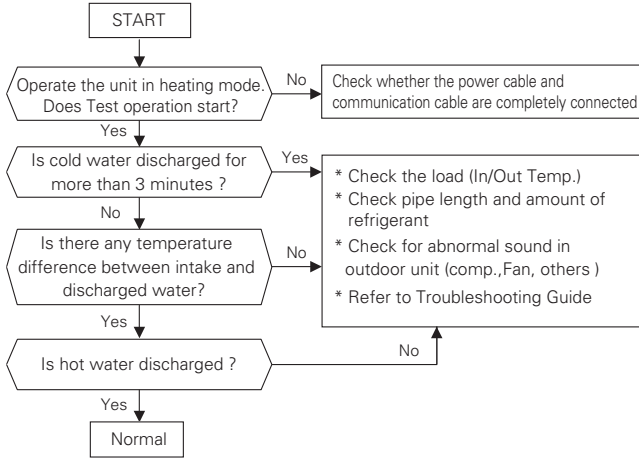

Airborne Noise Emission

The A-weighted sound pressure emitted by this product is below 70 dB.

** The noise level can vary depending on the site.

The figures quoted are emission level and are not necessarily safe working levels.

Whilst there is a correlation between the emission and exposure levels, this cannot be used reliably to determine whether or not further precautions are required.

Factor that influence the actual level of exposure of the workforce include the characteristics of the work room and the other sources of noise, i.e. the number of equipment and other adjacent processes and the length of time for which an operator exposed to the noise.

Also, the permissible exposure level can vary from country to country.

This information, however, will enable the user of the equipment to make a better evaluation of the hazard and risk.

Vacuum & Charge of Refrigerant

By default, the product was charged of refrigerant.
 Vacuum and refrigerant charge, If there is leak refrigerant.

1. Vacuum

To work of vacuum action. when the leak of refrigerant.

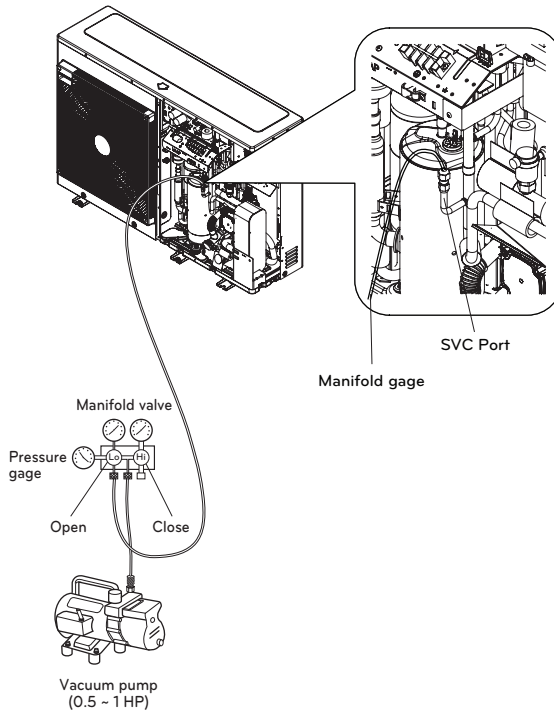

When selecting a vacuum, you should select one which is capable of achieving 0.2 Torr of ultimate vacuum.

	Unit	Standard atmospheric pressure	Perfect vacuum
Gage Pressure	Pa	0	-1.033
Absolute Pressure	kgf / cm ²	1.033	0

※ 0 Pa(gage)=1 atm=760 Torr=760 mmHg=1 013.25 hPa

* The feature may be vary according to the type of model.

2. Charge of refrigerant

You should be charged after vacuum.

You can see amount of refrigerant at quality label.

Please to charge at cooling mode when there is not full charging.

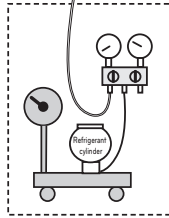
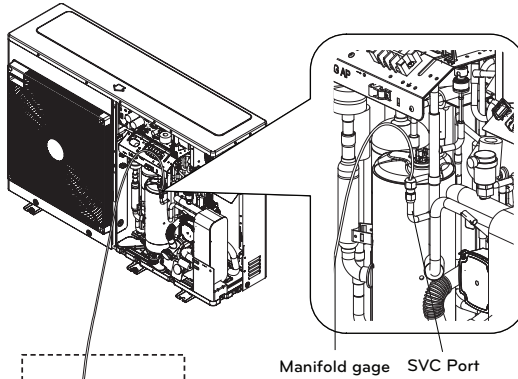

(R32 refrigerant)

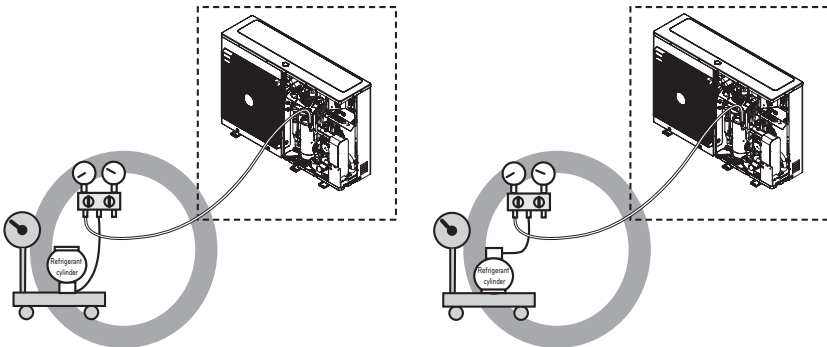

※ It is recommended to charge the refrigerant container upside down.

* The feature may be vary according to the type of model.

3. Location of SVC port

UN36A (5, 7, 9 kW)

UN60A (9, 12, 14, 16 kW)

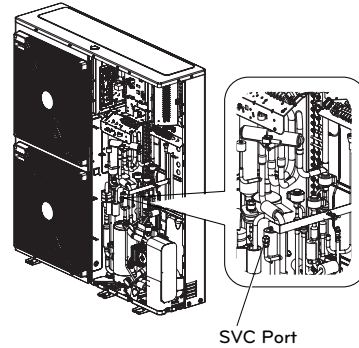
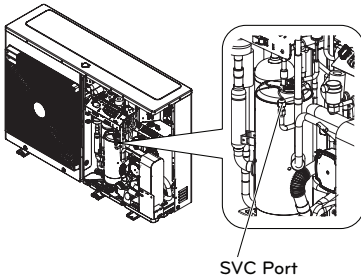

How to drain remaining water in the product

⚠ CAUTION

If the product is not used for a long period of time with remaining water, there is a risk of freezing in winter.

Step1

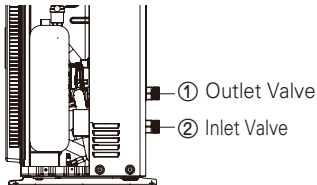

Step1. To drain most of the water out of the product, remove the water pipes from the inlet/outlet valve(①,②). After draining, reconnect them.

Step2

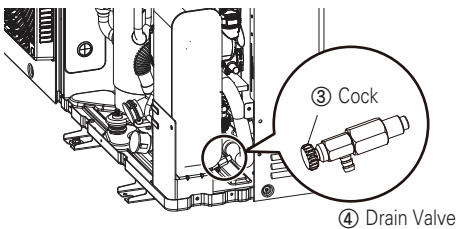

Step2. To drain the rest of the water out of the product, open the cock(③) of the drain valve(④) counterclockwise. After draining, lock it in the opposite direction to the end.

- To use the product again, you have to refill water in it. Refer to 'Water Charging' of 'Installation' part in this manual.

* The feature may vary according to the type of model.

Troubleshooting

If **THERMAV** operates not properly or it does not start operation, please check following list.

CAUTION

Turn off the power before proceeding troubleshooting

Troubleshooting for Problem while Operation

No	Problem	Reason	Solution
1	Heating or Cooling is not satisfactory.	<ul style="list-style-type: none"> Setting target temperature is not proper. 	<ul style="list-style-type: none"> Set target temperature correctly. Check if temperature is water-based or air-based. See 'Remote sensor active' and 'Temp. sensor selection'
		<ul style="list-style-type: none"> Charged water is not enough. 	<ul style="list-style-type: none"> Check pressure gage and charge more water until pressure gage is indication 2~2.5 Bar
		<ul style="list-style-type: none"> Water flow rate is low. 	<ul style="list-style-type: none"> Check if strainer gathers too much particles. If so, strainer should be cleaned. Check if pressure gage indicates above 4 Bar Check if water pipe is getting closed due to stacked particles or lime.
2	Although electric power supply is OK (remote controller displays information), the unit does not start working.	<ul style="list-style-type: none"> Water inlet temperature is too high. 	<ul style="list-style-type: none"> If water inlet temperature is above 57 °C, the unit does not operated for the sake of system protection
		<ul style="list-style-type: none"> Water inlet temperature is too low. 	<ul style="list-style-type: none"> If water inlet temperature is below 5 °C in cooling operation, the unit does not operated for the sake of system protection. Wait while unit warms up the water inlet temperature. If water inlet temperature is below 15 °C in heating operation, the unit does not operated for the sake of system protection. Wait while unit warms up to 18 °C the water inlet temperature. If you are not using the back up heater accessory (HA**1M E1), increase the water temperature with the external heat source (heater, boiler). If the problem persists, contact your dealer. If you want to use the screed drying function, be sure to purchase and install back up hater accessories (HA**1M E1).
3	Water pump noise.	<ul style="list-style-type: none"> Air purging is not completely finished. 	<ul style="list-style-type: none"> Open the cap of air purge and charge more water until pressure gage is indicating 2~2.5 Bar If water does not splash out when the tip(at the top of the hole) is pressed, then air purging is not completed yet. If well purged, the water will splash out like fountain.
		<ul style="list-style-type: none"> Water pressure is low. 	<ul style="list-style-type: none"> Check if pressure gage indicates above 0.3 Bar. Check if the expansion tank and pressure gage operates well.
4	Water is flood out through drain hose.	<ul style="list-style-type: none"> Too much water is charged. 	<ul style="list-style-type: none"> Flood out water by opening the switch of the safety valve until pressure gage is indicating 2~2.5 Bar.
		<ul style="list-style-type: none"> Expansion tank is damaged. 	<ul style="list-style-type: none"> Replace the expansion tank
5	DHW is not hot.	<ul style="list-style-type: none"> Thermal protector of water tank heater is activated. 	<ul style="list-style-type: none"> Open the side panel of the DHW tank and push the reset button of the thermal protector. (for more detail information, please refer to installation manual of DHW tank.
		<ul style="list-style-type: none"> DHW Heating is disabled. 	<ul style="list-style-type: none"> Select DHW Heating Operation and identify if icon is displayed on the remote controller.

Troubleshooting for Error Code

Display code	Title	Cause of error	Check point & Normal condition
1	Problem in remote room air sensor	<ul style="list-style-type: none"> • Incorrect connection between sensor and PCB(Heater). • PCB(Heater) fault • Sensor fault 	<ul style="list-style-type: none"> • Resistance: 10 kΩ at 25 centigrade (unplugged) → for Remote room air sensor • Resistance: 5 kΩ at 25 centigrade (unplugged) → for all sensors EXCEPT remote room air sensor • Voltage: 2.5 V DC at 25 centigrade (plugged) (for all sensors) • Refer resistance-temperature table to check in different temperature
2	Problem in refrigerant (inlet side) sensor		
6	Problem in refrigerant (outlet side) sensor		
8	Problem in water tank sensor		
13	Problem in solar pipe sensor		
16	Problems in sensors		
17	Problem in water-inlet sensor		
18	Problem in water-outlet sensor		
19	Problem in electric heater outlet sensor		
10	BLDC Water pump Lock	Restriction of BLDC Water pump	<ul style="list-style-type: none"> • BLDC Water pump defect / assembly condition abnormal • Fan lock by foreign material
3	Bad communication between remote controller and unit.	<ul style="list-style-type: none"> • Incorrect connection between sensor and PCB(Heater) • PCB(Heater) fault • Sensor fault 	<ul style="list-style-type: none"> • Wire connection between remote controller and Main PCB assembly(Heater) should be tight • Output voltage of PCB should be 12 V DC
5	Bad communication between Main PCB assembly(Heater) and Main PCB assembly(Inverter) of the unit.	<ul style="list-style-type: none"> • The connector for transmission is disconnected • The connecting wires are misconnected • The communication line is broken • Main PCB assembly(Inverter) is abnormal • Main PCB assembly(Heater) is abnormal 	<ul style="list-style-type: none"> • Wire connection between remote control panel and Main PCB assembly(Heater) should be tight.
53			
9	PCB program (EEPROM) fault	<ul style="list-style-type: none"> • Electrical or mechanical damage a the EEPROM 	<ul style="list-style-type: none"> • This error can not be permitted
14	Problem in flow switch	<ul style="list-style-type: none"> • Flow switch is open while internal water pump is working 	<ul style="list-style-type: none"> • Flow switch should be closed while internal water pump is working
15	Water pipe overheated	<ul style="list-style-type: none"> • Abnormal operation of electric heater • Leaving water temperature is above 72 °C. 	<ul style="list-style-type: none"> • If there is no problem in electric heater control, possible maximum leaving water temperature is 72 °C
20	Thermal fuse is damaged	<ul style="list-style-type: none"> • Thermal fuse is cut off by abnormal overheating of internal electric heater • Mechanical fault at thermal fuse • Wire is damaged 	<ul style="list-style-type: none"> • This error will not be happened if temperature of electric heater tank is below 80 °C

Display code	Title	Cause of error	Check point & Normal condition
21	DC PEAK (IPM Fault)	<ul style="list-style-type: none"> Instant over current Over Rated current Poor insulation of IPM 	<ul style="list-style-type: none"> An instant over current in the U,V,W phase <ul style="list-style-type: none"> - Comp lock - The abnormal connection of U,V,W Over load condition <ul style="list-style-type: none"> - Overcharging of refrigerant Pipe length. Outdoor Fan is stop Poor insulation of compressor
22	Max. C/T	Input Over Current	<ul style="list-style-type: none"> Malfunction of Compressor Blocking of Pipe Low Voltage Input Refrigerant, Pipe length, Blocked...
23	DC Link High / Low Volt	<ul style="list-style-type: none"> DC Link Voltage is above 420 V DC DC Link Voltage is below 140 V DC 	<ul style="list-style-type: none"> Check CN_(L), CN_(N) Connection Check Input Voltage Check PCB DC Link voltage sensor parts
24	Low/High Pressure Switch Perception Error	<ul style="list-style-type: none"> Low pressure is below 0.2 kgf/cm². High pressure is above 42-44 kgf/cm². Pressure switch is self-defective. 	<ul style="list-style-type: none"> Check the low/high pressure Check the connection of harness
26	DC Compressor Position	<ul style="list-style-type: none"> Compressor Starting fail error 	<ul style="list-style-type: none"> Check the connection of comp wire "U,V,W" Malfunction of compressor Check the component of "IPM", detection parts.
27	AC Input Instant over Current Error	PCB(Inverter) input current is over 100 A(peak) for 2 us	<ul style="list-style-type: none"> Overload operation (Pipe clogging/Covering/EEV defect/Ref. overcharge) Compressor damage (Insulation damage/Motor damage) Input voltage abnormal (L,N) Power line assemble condition abnormal PCB assembly 1 Damage (input current sensing part)
29	Inverter compressor over current	(HM**1M U*3) Inverter Compressor input current is 35 Apk. (HM**3M U*3) Inverter Compressor input current is 35 Apk.	<ul style="list-style-type: none"> Overload operation (Pipe clogging/Covering/EEV defect/Ref. overcharge) Compressor damage(Insulation damage/Motor damage) Input voltage low ODU PCB assembly 1 damage
32	High temperature in Discharge pipe of the inverter compressor	<ul style="list-style-type: none"> Overload operation (Outdoor fan constraint, screened, blocked) Refrigerant leakage (insufficient) Poor INV Comp Discharge sensor LEV connector displaced / poor LEV assembly 	<ul style="list-style-type: none"> Check outdoor fan constraint/ screened/ flow structure Check refrigerant leakage Check if the sensor is normal Check the status of EEV assembly
35	Low pressure Error	Excessive decrease of low pressure	<ul style="list-style-type: none"> Defective low pressure sensor Defective unit fan Refrigerant shortage/leakage Deformation because of damage of refrigerant pipe Defective unit EEV Covering / clogging (unit covering during the cooling mode / unit filter clogging during heating mode) SVC valve clogging Defective unit PCB(Inverter) Defective unit pipe sensor

Display code	Title	Cause of error	Check point & Normal condition
41	Problem in D-pipe temperature sensor	<ul style="list-style-type: none"> • Open / Short • Soldered poorly • Internal circuit error 	<ul style="list-style-type: none"> • Bad connection of thermistor connector • Defect of thermistor connector (Open/Short) • Defect of outdoor PCB(Inverter)
43	Problem in high pressure sensor	Abnormal value of sensor (Open/Short)	<ul style="list-style-type: none"> • Bad connection of connector PCB(Inverter) • Bad connection high pressure connector • Defect of high pressure connector (Open/Short) • Defect of connector PCB(Inverter) (Open/Short) • Defect of PCB(Inverter)
44	Problem in outdoor air temperature sensor	<ul style="list-style-type: none"> • Open / Short • Soldered poorly • Internal circuit error 	<ul style="list-style-type: none"> • Bad connection of thermistor connector • Defect of thermistor connector (Open/Short) • Defect of outdoor PCB(Inverter)
45	Problem in Cond. middle pipe temperature sensor	<ul style="list-style-type: none"> • Open / Short • Soldered poorly • Internal circuit error 	<ul style="list-style-type: none"> • Bad connection of thermistor connector • Defect of thermistor connector (Open/Short) • Defect of outdoor PCB(Inverter)
46	Problem in suction pipe temperature sensor	<ul style="list-style-type: none"> • Open / Short • Soldered poorly • Internal circuit error 	<ul style="list-style-type: none"> • Bad connection of thermistor connector • Defect of thermistor connector (Open/Short) • Defect of outdoor PCB(Inverter)
52	PCB Communication Error	Checking the communication state between Main PCB and Inverter PCB	<ul style="list-style-type: none"> • Generation of noise source interfering with communication
54	Open and Reverse Phase Error	Prevention of phase unbalance and prevention of reverse rotation of constant-rate compressor	<ul style="list-style-type: none"> • Main power wiring fault
60	PCB(Inverter) & Main EEPROM check sum error	EEPROM Access error and Check SUM error	<ul style="list-style-type: none"> • EEPROM contact defect/wrong insertion • Different EEPROM Version • ODU Inverter & Main PCB assembly 1 damage
61	High temperature in Cond. Pipe	<ul style="list-style-type: none"> • Overload operation (Outdoor fan constraint, screened, blocked) • Unit heat exchanger contaminated • EEV connector displaced / poor EEV assembly • Poor Cond. Pipe sensor assembly / burned 	<ul style="list-style-type: none"> • Check outdoor fan constraint / screened / flow structure • Check if refrigerant overcharged • Check the status of EEV assembly • Check the status of sensor assembly / burn
62	Heat sink Temp, High error	Heatsink temperature is greater than 110 °C.	<ul style="list-style-type: none"> • Part no. : EBR37798101~09 <ul style="list-style-type: none"> - Check the heatsink sensor: 10 kΩ / at 25 °C(Unplugged) - Check the outdoor fan is driving rightly • Part no. : EBR37798112~21 <ul style="list-style-type: none"> - Check the soldered condition in the 22,23 pin of IPM, PFCM - Check the screw torque of IPM, PFCM - Check the spreadable condition of thermal grease on IPM, PFCM - Check the outdoor fan is driving rightly
65	Problem in Heatsink Temperature sensor	Abnormal value of sensor (Open/Short)	<ul style="list-style-type: none"> • Check if there is defect of thermistor connector (Open/Short) • Check defect of outdoor PCB(Inverter)

Display code	Title	Cause of error	Check point & Normal condition
67	Fan lock error	Fan RPM is less than 10 for 5 seconds from start-up operation. Fan RPM is less than 40 in operation except for start-up operation	<ul style="list-style-type: none"> • Fan motor damage • Assembly condition abnormal • Jammed fan by surroundings
114	Problem in Vapor injection inlet temperature sensor	<ul style="list-style-type: none"> • Open (Below -48.7 °C)/ Short(Over 96.2 °C) • Soldered poorly • Internal circuit error 	<ul style="list-style-type: none"> • Bad connection of thermistor connector • Defect of thermistor connector (Open/Short) • Defect of outdoor PCB(Outdoor)
115	Problem in Vapor injection outlet temperature sensor	<ul style="list-style-type: none"> • Open (Below -48.7 °C)/ Short(Over 96.2 °C) • Soldered poorly • Internal circuit error 	<ul style="list-style-type: none"> • Bad connection of thermistor connector • Defect of thermistor connector (Open/Short) • Defect of outdoor PCB(Outdoor)



Manufacturer :

LG Electronics Inc.

84, Wanam-ro, Seongsan-gu, Changwon-si, Gyeongsangnam-do, KOREA

UK Importer :

LG Electronics U.K. Ltd

Velocity 2, Brooklands Drive, Weybridge, KT13 0SL

Eco design requirement

- The information for Eco design is available on the following free access website.
<https://www.lg.com/global/support/cedoc/cedoc>