



ENGLISH

FRANÇAIS

PORTUGUÊS

OWNER'S MANUAL

# Audio/Video Receiver

Please read this manual carefully before operating your set and retain it for future reference.

Some of the content in this manual may differ from your unit.

MODEL

ARX5 (ARX5, S63S6-S, S75T1-W)



MFL68962877

[www.lg.com](http://www.lg.com)

Copyright © 2018 LG Electronics Inc. All Rights Reserved.

## Safety information



**CAUTION:** TO REDUCE THE RISK OF ELECTRIC SHOCK DO NOT REMOVE COVER (OR BACK) NO USER-SERVICEABLE PARTS INSIDE REFER SERVICING TO QUALIFIED SERVICE PERSONNEL

This lightning flash with arrowhead symbol within an equilateral triangle is intended to alert the user to the presence of uninsulated dangerous voltage within the product's enclosure that may be of sufficient magnitude to constitute a risk of electric shock to persons.



The exclamation point within an equilateral triangle is intended to alert the user to the presence of important operating and maintenance (servicing) instructions in the literature accompanying the product.



**WARNING:** TO PREVENT FIRE OR ELECTRIC SHOCK HAZARD, DO NOT EXPOSE THIS PRODUCT TO RAIN OR MOISTURE.

**WARNING:** Do not install this equipment in a confined space such as a book case or similar unit.

**CAUTION:** The apparatus should not be exposed to water (dripping or splashing) and no objects filled with liquids, such as vases, should be placed on the apparatus.

**CAUTION:** Do not use high voltage products around this product. (ex. Electrical swatter) This product may malfunction due to electrical shock.

**CAUTION:** Do not block any ventilation openings. Install in accordance with the manufacturer's instructions.

Slots and openings in the cabinet are provided for ventilation and to ensure reliable operation of the product and to protect it from over heating. The openings shall be never be blocked by placing the product on a bed, sofa, rug or other similar surface. This product should not be placed in a built-in installation such as a bookcase or rack unless proper ventilation is provided or the manufacturer's instruction has been adhered to.

### CAUTION concerning the Power Cord

The Power Plug is the disconnecting device. In case of an emergency, the Power Plug must remain readily accessible.

Check the specification page of this owner's manual to be certain of the current requirements.

Do not overload wall outlets. Overloaded wall outlets, loose or damaged wall outlets, extension cords, frayed power cords, or damaged or cracked wire insulation are dangerous. Any of these conditions could result in electric shock or fire. Periodically examine the cord of your device, and if its appearance indicates damage or deterioration, unplug it, discontinue use of the device, and have the cord replaced with an exact replacement part by an authorized service center. Protect the power cord from physical or mechanical abuse, such as being twisted, kinked, pinched, closed in a door, or walked upon. Pay particular attention to plugs, wall outlets, and the point where the cord exits the device.

**NOTICE:** For safety marking information including product identification and supply ratings, please refer to the main label on the bottom or the other surface of the product.

This device is equipped with a portable battery or accumulator.

**How to Safely remove the batteries or the battery pack from the equipment:** To Remove the old batteries or battery pack, follow the assembly steps in reverse order. To prevent contamination of the environment and bring on possible threat to human and/or animal health, the old batteries or the battery pack must be put in an appropriate container at designated collection points. Do not dispose of batteries or battery pack together with other waste. It is recommended that you use local, free reimbursement systems batteries or battery packs, (may not be available in your area). The batteries or the battery pack should not be exposed to excessive heat such as sunshine, fire or the like.

**CAUTION:** No naked flame sources, such as lighted candles, should be placed on the apparatus.

## Symbols

~	Refers to alternating current(AC).
==	Refers to direct current(DC).
⊞	Refers to class II equipment.
⏻	Refers to stand-by.
I	Refers to "ON" (power).
⚡	Refers to dangerous voltage.

# Table of Contents

## 1 Getting Started

---

- 2 Safety information
- 6 Unique features
- 6 Accessories
- 6 Introduction
- 6 – Symbols Used in this Manual
- 7 – Required cables
- 8 Remote control
- 10 Front panel
- 11 Rear panel

## 2 Connecting

---

- 12 Spekaer installation
- 13 Before connecting
- 13 Positioning the system
- 14 Attaching the speakers to the unit
- 15 Connecting TV with other devices
- 15 – Using an HDMI cable
- 17 – Using a composite video cable
- 18 Connecting audio devices
- 19 Connecting other devices
- 20 Connecting the antenna
- 20 Connecting portable devices

## 3 System Setting

---

- 21 Settings and adjustments using the SETUP menu
- 21 – SETUP configuration
- 21 – TESTTONE menu
- 22 – LEVEL menu
- 22 – DISTANCE menu
- 23 – A/V SYNC menu (Adjusting the audio delay)
- 23 – DOLBY DRC menu
- 23 – RESET menu

## 4 Operating

---

- 24 Selecting the input source
- 24 – By using the knob on the unit
- 24 – By using the remote control
- 25 USB Operation
- 25 – Basic Operations
- 25 – Selecting a folder and an MP3/WMA file
- 26 – Deleting an MP3/WMA file
- 26 – Playing repeatedly or randomly
- 26 – To activate the mute function
- 27 – Playable file Requirement
- 27 – Playback effect
- 30 Enjoying various sound mode
- 30 – Setting the USER EQ
- 31 – LG Sound Sync
- 32 Using a BLUETOOTH® wireless technology
- 32 – Listening to music stored on the Bluetooth devices
- 34 – Using the Music Flow Bluetooth App
- 35 – Activate Bluetooth with “Music Flow Bluetooth” App
- 36 Radio Operations
- 36 – Listening to FM radio
- 36 – Improving poor FM reception
- 36 – Presetting the Radio Stations
- 36 – Deleting all the saved stations

37	Other Operations
37	– Dimmer
37	– Using the Sleep Timer
37	– Displaying file and input source
37	– Auto power down
37	– AUTO POWER On/Off
38	Advanced Operations
38	– Recording to USB

## 5 Troubleshooting

---

39	Troubleshooting
----	-----------------

## 6 Appendix

---

40	Controlling a TV with the Supplied Remote Control
40	– Setting up the remote to control your TV
41	Trademarks and licenses
41	Maintenance
41	– Handling the unit
42	Specifications

1

2

3

4

5

6

## Unique features

### Bluetooth®

Listens to music stored on your **Bluetooth** device.

### Portable In

Listens to music from your portable device. (MP3, Notebook, etc.)

### Playback effects

Listens to music various sound and playback effects.

### USB Direct Recording

Records music to your USB device. (analog sources only.)

### Music Flow Bluetooth

Music Flow Bluetooth is an App designed to let you take control of some of LG's latest Audio devices. Refer to the page 34-35.

### LG Sound Sync

Controls volume level of this unit by the remote control of your LG TV that is compatible with LG Sound Sync.

## Accessories

Please check and identify the supplied accessories.

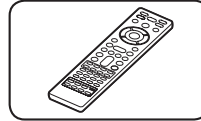

Remote control (1)

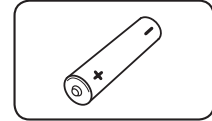

Battery (1)

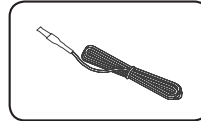

FM antenna (1)

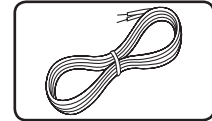

Speaker cables (4)

## Introduction

### Symbols Used in this Manual

#### ! Note

Indicates special notes and operating features.

#### ⚠ Caution

Indicates cautions for preventing possible damages from abuse.

## Required cables

The hookup diagrams on the subsequent pages assume the use of the following connection cables. You must purchase the connection cables separately if necessary.

- Analog audio cable



- Composite video cable



- Analog audio/Composite video cable



- Optical digital audio cable



- HDMI cable



- Portable cable ( $\phi$  3.5 mm Stereo plug)



### ! Note

- Turn off the power to all components before making any connections.
- When connecting an audio/video cable, be sure to match the color-coded pins to the appropriate jacks on the components: yellow (video) to yellow; white (left, audio) to white; and red (right, audio) to red.
- When connecting optical digital cables, insert the cable plugs straight in until they click into place.
- Do not bend or tie optical digital audio cables.

1

Getting Started

# Remote control

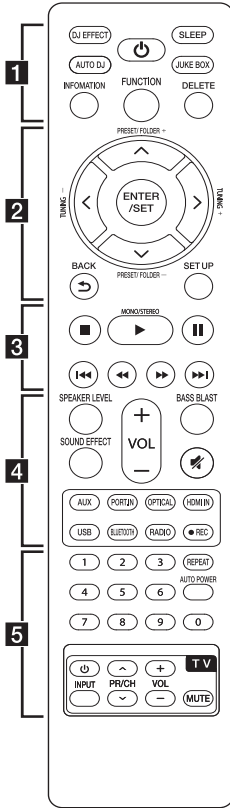

.....**1**.....

**DJ EFFECT** : Selects a desired DJ EFFECT. (Refer to page 28.)

**⏻** : Switches the unit ON or OFF.

**SLEEP** : Sets dimmer or the system to turn off automatically at a specified time.

**AUTO DJ** : Selects the AUTO DJ mode. (For more information refer to the page 28.)

**JUKE BOX** :  
 - Selects JUKE BOX mode.  
 - Makes your favorites list.

**INFORMATION** :  
 - Displays the information of a file or an input source.  
 - Sees the name of connected all Bluetooth device in Bluetooth mode.

**FUNCTION** : Selects the function and the input source.

**DELETE** :  
 - Deletes MP3/WMA files or folders.  
 - Deletes a song on JUKE BOX list.

.....**2**.....

**ENTER/SET** : Acknowledges menu selection.

**PRESET/FOLDER (-/+)** :  
 - Selects a preset stations.  
 - Searches a folder on USB device.

**TUNING (-/+)** : Tunes in the desired radio station.

**^/v/</>** (up/ down/ left/ right): Selects an option in the menu.

**⏪ BACK** : Moves backwards in the menu or exits the setup menu.

**SETUP** : Displays or exits the [SETUP] menu.

## Replacement of battery

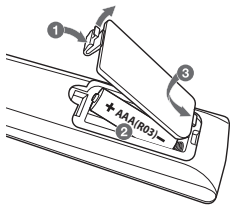

Remove the battery cover on the rear of the Remote Control, and insert the battery with **+** and **-** matched correctly.

## 3

■ : Stops playback.

▶ **MONO/STEREO** :

- Starts playback.
- Selects MONO/STEREO in FM mode.

⏸ : Pauses playback.

⏮/⏭ : Goes to the next or previous file.

⏪/⏩ : Searches backward or forward.

## 4

**SPEAKER LEVEL** : Sets the sound level of desired speaker.

**VOL (-/+)** : Adjusts speaker volume.

**BASS BLAST** : Selects the BASS BLAST sound mode directly.

**SOUND EFFECT** : Selects a sound effect mode.

🔊 : Turns off the sound temporarily. Press the button again to restore the sound.

**INPUT buttons** : Selects the input source you want to use. (For more information refer to the page 24.)

- **AUX** : Selects the input source connected to AUX IN 1/2(L/R) jack.
- **PORT.IN** : Selects the input source connected to PORT.IN jack.
- **OPTICAL** : Selects the input source connected to OPTICAL IN jack.
- **HDMI IN** : Selects the input source connected to HDMI IN 1/2/3 jack.
- **USB** : Selects the input source connected to USB port.
- **BLUETOOTH** : Selects Bluetooth function.
- **RADIO** : Selects the FM tuner.
- **REC** : USB direct recording. (Refer to the page 38.)

## 5

**0 to 9 numerical buttons** :

- Selects numbered options in a menu.
- Selects numbered tracks, files, or preset number.

**REPEAT** : Listens to your files repeatedly or randomly.

**AUTO POWER** : Turns on or off AUTO POWER function. (Refer to the page 37.)

**TV Control Buttons** : Refer to the page 40.

## Front panel

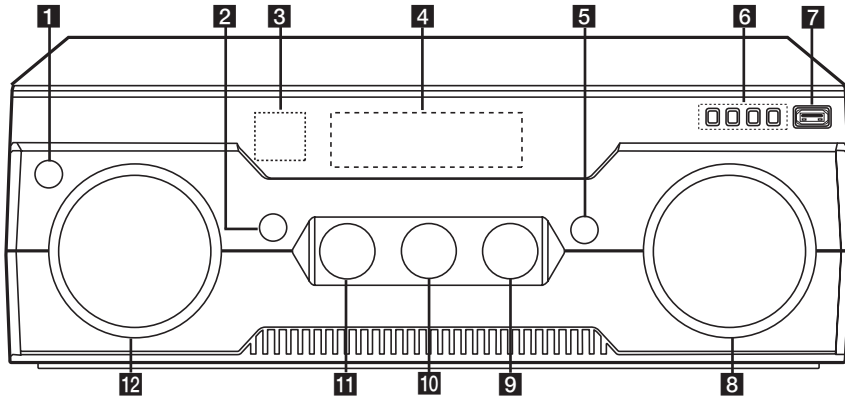

- 1** **⏻/⏻ (STANDBY/ON)**  
Switches the unit ON or OFF.
- 2** **BASS BLAST**  
Selects the BASS BLAST sound mode directly.
- 3** Remote sensor
- 4** Display window  
Shows the current status of the unit.
- 5** **DJ EFFECT**  
Selects DJ effect. (For more information refer to the page 28.)
- 6** **USER EQ**  
Sets the USER EQ mode (BASS, MIDDLE and TREBLE). (For more information refer to the page 30.)
- ENTER**
- Acknowledges menu selection.
  - Enters USER EQ/ Confirms USER EQ setting. (For more information refer to the page 30.)
- PLAY/PAUSE**
- Starts playback.
  - Pauses playback, press it again to exit pauses status.
  - Selects BASS, MIDDLE or TREBLE while in "USER EQ" mode by pressing **PLAY/PAUSE** repeatedly.(For more information refer to the page 30.)
- STOP**  
Stops playback.
- 7** **USB port (5 V  $\overline{\text{---}}$  500 mA)**  
Connects an USB device to USB port.
- 8** **MASTER VOLUME**  
Adjusts the speaker volume.
- 9** **CONTROL**
- Control the DJ EFFECT and DJ PRO.
  - Adjust USER EQ sound level. (For more information refer to the page 30.)
- 10** **DJ PRO**  
Selects DJ PRO effect. (For more information refer to the page 27.)
- 11** **SOUND EFFECT**  
Selects Sound effect.
- 12** **INPUT SELECTION**  
Selects input source.

## Rear panel

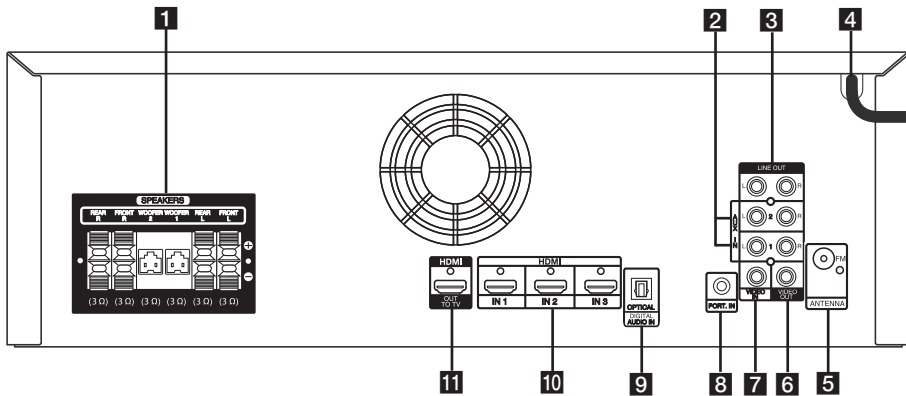

### 1 SPEAKERS

Connects the speaker cables.

### 2 AUX IN 1/2 (L/R)

Connects to external source with 2 channel audio outputs.

### 3 LINE OUT (L/R)

Connects the components with 2 channel audio inputs.

### 4 Power cord

### 5 ANTENNA

FM – Connects the FM wired antenna.

### 6 VIDEO OUT

Connects the components with analog video input jacks.

### 7 VIDEO IN

Connects the components with analog video output jacks.

### 8 PORT. IN

Connects a portable device (MP3 player; etc) to PORT. IN jack.

### 9 DIGITAL AUDIO IN

#### OPTICAL

Connects other components with an optical digital audio output.

### 10 HDMI IN 1/2/3

Connects the component with HDMI output.

### 11 HDMI OUT TO TV

Connects to TV with HDMI inputs.

# Spekaer installation

## A. Stand type

You can adjust angle of speaker.

2  
Connecting

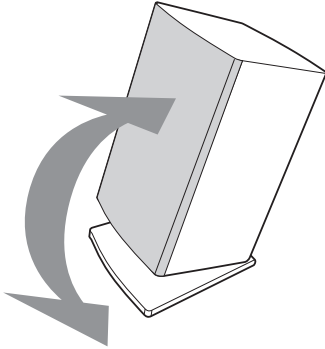

- Separates stand

Separate the stand from the speaker as shown below.

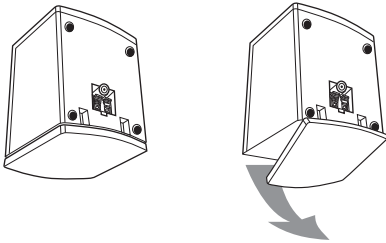

## B. Wall type (Mounting the speakers to a Wall)

1. Separate the stand from the speaker.
2. Attach the stand to the speaker as shown below.
3. You can adjust angle of speaker.
4. Fix the stand to the speaker by rotating the screw.
5. Drive 1 screw in the wall for the speaker and then hook the speaker over there.

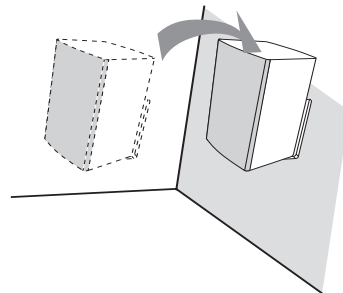
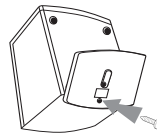
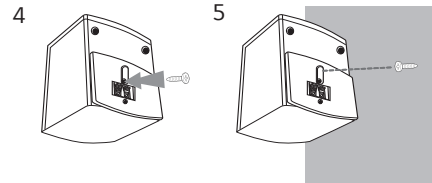
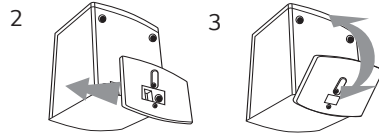

## Before connecting

Please make sure to disconnect the AC power cord before making any connection between the unit and any other device.

## Positioning the system

The following illustration shows an example of positioning the system. Note that the illustrations in these instructions differ from the actual unit for explanation purposes.

For the best possible surround sound, all the speakers other than the subwoofer should be placed at the same distance from the listening position (A).

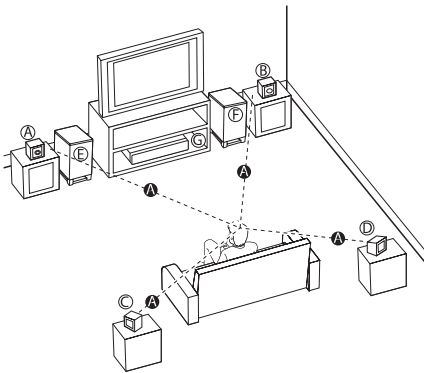

Ⓐ Front speaker (L)

Ⓑ Front speaker (R)

Place the front speakers to the sides of the monitor or screen and as flush with the screen surface as possible.

Ⓒ Rear speaker (L)

Ⓓ Rear speaker (R)

Place these speakers behind your listening position, facing slightly inwards.

Ⓔ Subwoofer (1)

Ⓕ Subwoofer (2)

The position of the subwoofer is not so critical, because low bass sounds are not highly directional. But it is better to place the subwoofer near the front speakers. Turn it slightly toward the center of the room to reduce the wall reflections.

Ⓖ Unit

## Attaching the speakers to the unit

2

Connecting

1. Connect the wires to the unit.  
Match each wire's colored band to the same colored connection terminal on the rear of the unit. To connect the cable to the unit, press each plastic finger pad to open the connection terminal. Insert the wire and release the finger pad.

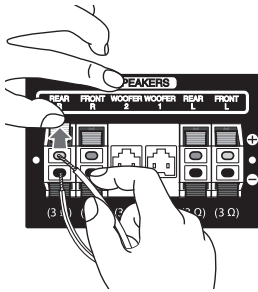

Connect the black stripe of each wire to the black finger pad and the other end to the colored finger pad.

Connect a woofer cord to the unit. When connecting a woofer cord to the unit, insert the connector until it clicks.

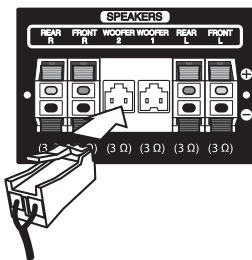

2. Connect the wires to the speakers.  
Connect the other end of each wire to the correct speaker according to the color coding:

Color	Speaker	Position
Grey	REAR R	Rear right
Blue	REAR L	Rear left
Orange	WOOFER 1	Any front position
Orange	WOOFER 2	Any front position
Red	FRONT R	Front right
White	FRONT L	Front left

To connect the cable to the speakers, press each plastic finger pad to open the connection terminals on the base of each speaker. Insert the wire and release the finger pad.

### Caution

- Check the volume level before playing music to prevent infirm, child, and pregnant women from being shocked by the sudden and loud sound from the unit.
- Do not use the unit in a limited space. It may damage a person's hearing. It is recommended to use it in a wide space.
- Be careful to make sure children not to put their hands or any objects into the opening speaker duct hole.
- The speakers contain magnet parts, so color irregularity may occur on the TV screen or PC monitor screen. Please use the speakers far away from either TV screen or PC monitor.
- Use the speaker supplied with this unit only. Using any other speaker may cause malfunction.
- Before using the subwoofer, remove the protective vinyl.

## Connecting TV with other devices

You can watch the input image from your video device. There are two ways of connecting your video device to AV Receiver System.

### Using an HDMI cable

Since HDMI offers both audio and video signal over one cable, you can enjoy them without additional audio cable.

1. Connect the **HDMI IN 1/2/3** jack on AV Receiver System to your video device with HDMI OUT jack using HDMI cable.
2. Connect the **HDMI OUT TO TV** jack on AV Receiver System to the HDMI IN jack on your TV.
3. Set the input source to HDMI (refer to the page 24).

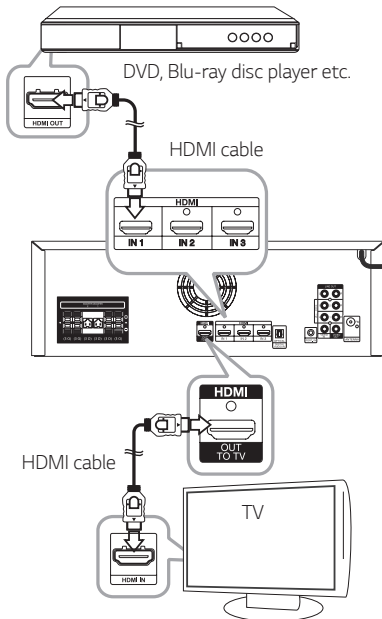

**Note**

- HDMI is the abbreviated name for High Definition Multimedia Interface. It is an interface which transmits video and audio signals in digital format. If a connected HDMI device does not accept the audio output of the unit, the HDMI device's audio sound may be distorted or may not output.
- When you connect a HDMI or DVI compatible device make sure of the followings :
  - Try switching off the HDMI/DVI device and this unit. Next, switch on the HDMI/DVI device and leave it for around 30 seconds, then switch on this unit.
  - The connected device's video input is set correctly for this unit.
  - The connected device is compatible with 720 x 576i (or 480i), 720 x 576p (or 480p), 1280 x 720p, 1920 x 1080i or 1920 x 1080p video input.
  - This unit does not support 4K device normally. So if you use 4K device, please connect to TV directly.
- Not all HDCP-compatible HDMI or DVI devices will work with this unit.
- The picture will not be displayed properly with non-HDCP device.
- This unit does not playback and TV screen is changed to black screen.
- If there are noises or lines on the screen, please check the HDMI cable (length is generally limited to 4.5 m(15 ft)).
- Changing the resolution when the connection has already been established may result in malfunctions. To solve the problem, turn off the unit and then turn it on again.
- When the HDMI connection with HDCP is not verified, TV screen is changed to black screen. In this case, check the HDMI connection, or disconnect the HDMI cable.
- When DTS source is connected through HDMI IN jacks, the external device will convert from DTS source to PCM.

## Using a composite video cable

To enjoy both sounds and pictures from your device, you have to connect analog audio cable as well as composite video cable.

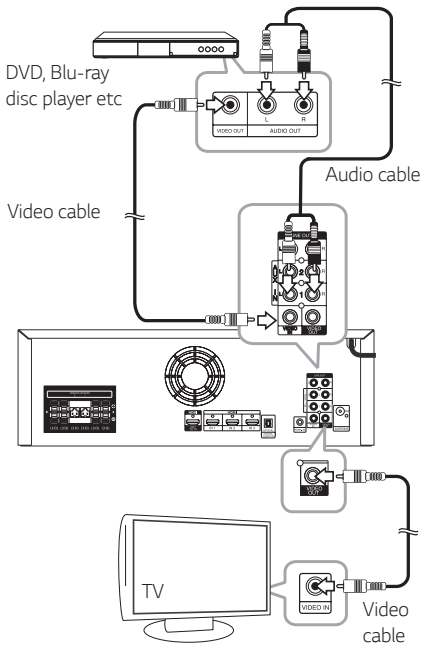

1. Connect the **VIDEO IN** jack on AV Receiver System to the VIDEO OUT jack on your video device using a composite video cable.
2. Connect the **AUX IN 1/2 (L/R)** jacks of AV Receiver System to the left and right AUDIO OUT jacks on your video device using an audio cables.
3. Connect the **VIDEO OUT** jack on your AV Receiver System to the VIDEO IN jack on your TV.
4. Set the input source to AUX1/2 (refer to the page 24).

### ! Note

- When connecting an audio/video cable, be sure to match the color-coded pins to the appropriate jacks on the components: yellow (video) to yellow; white (left, audio) to white; and red (right, audio) to red.
- When both the VIDEO IN and VIDEO OUT jacks are connected, the video signals can be output from the VIDEO OUT jack, even if this unit has been turned off.

## Connecting audio devices

You can hear the sound from your TV, DVD player, Blu-ray player, CD player, etc.

It is not necessary to connect all the cables. Connect AV Receiver System to an AUX, an OPTICAL jack on your device you want to connect.

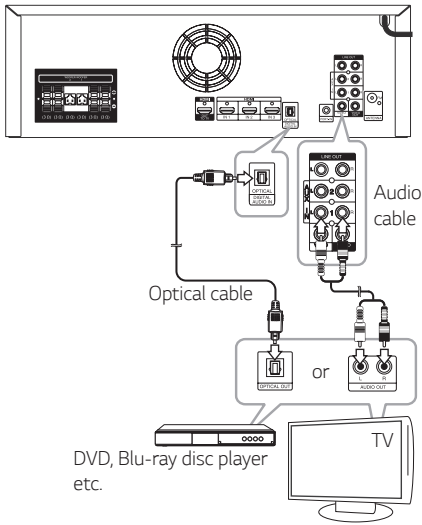

1. Connect **AUX1/2 IN (L/R)**, **OPTICAL** jack on AV Receiver System to your audio device's **OUTPUT** jack you want.
2. Set the input source to **AUX 1/2** or **OPTICAL** you connect (Refer to the page 24).

### ! Note

- When connecting an audio/video cable, be sure to match the color-coded pins to the appropriate jacks on the components: yellow (video) to yellow; white (left, audio) to white; and red (right, audio) to red.
- When connecting OPTICAL jack, DTS is not output.

## Connecting other devices

You can connect various devices (TV, recorder, etc) to the jacks on AV receiver system.

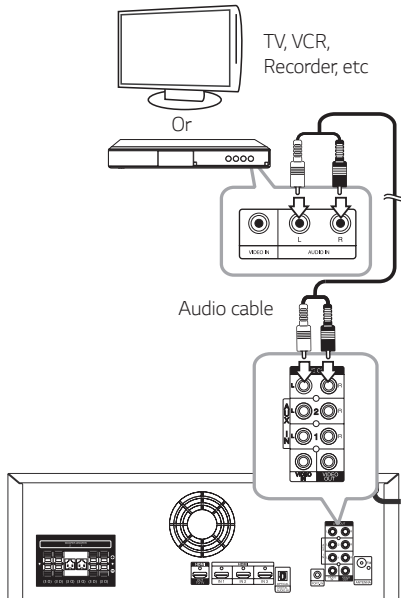

1. Connect the **LINE OUT** jacks on AV Receiver System to your device's **INPUT** jack you want
2. Set the input source to FM, PORTIN or AUX1/2 you connect (Refer to the page 24).

Refer to "Connecting audio devices" and "Connecting portable device" when you connect external device.

### ! Note

- When connecting an audio/video cable, be sure to match the color-coded pins to the appropriate jacks on the components: yellow (video) to yellow; white (left, audio) to white; and red (right, audio) to red.
- It is only output analog signal. (FM, portable, or AUX1/2)
- When you connect to a TV by using only audio cable, TV AV setup menu may not be activated (It depends on TV models). But audio will be outputted normally.
- The sound through LINE OUT (L/R) is output only original sound.

## Connecting the antenna

1. Connect the FM wire antenna to the FM antenna connector.

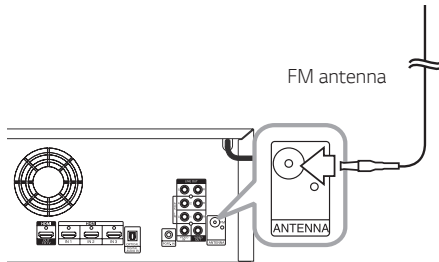

2. Set the input source to FM tune (refer to the page 24).

### ! Note

Be sure to fully extend the FM wire antenna.

## Connecting portable devices

1. Connect the **PORT. IN** jack on the rear panel of AV Receiver System to **LINE OUT** jack on your portable device (MP3 player, etc.) using a portable cable (∅ 3.5 mm stereo plug).

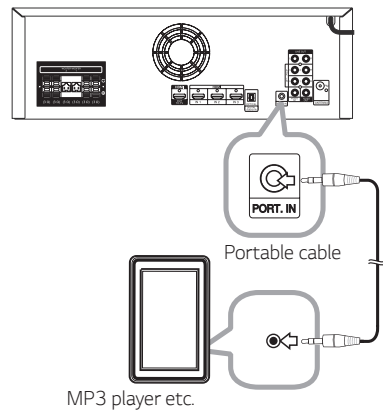

2. Set the input source to PORTABLE (refer to the page 24).

# Settings and adjustments using the SETUP menu

By using the SETUP menus, you can make various adjustments to customize the unit.

## SETUP configuration

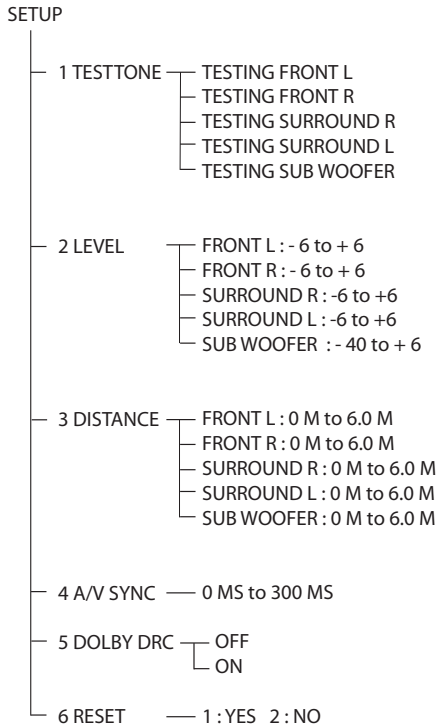

## TESTTONE menu

You can adjust the speaker levels while listening to the test tone from your listening position.

1. Press **SETUP**.  
"1 TESTTONE" appears on the display window.
2. Press **ENTER/SET**.  
The test tone is emitted from each speaker in sequence as follows:

TESTING FRONT L → TESTING FRONT R →  
TESTING SURROUND R → TESTING SURROUND  
L → TESTING SUB WOOFER

You can select desired speakers manually by pressing **▲/▼** repeatedly

3. You can verify each speakers tone.
4. Press **◀BACK** to move to the previous menu.  
Press **SETUP** to exit the setup menu.

## LEVEL menu

You can adjust the level of each speaker to suit your preference.

1. Press **SETUP**.  
"1 TESTTONE" appears on the display window.
2. Press **▲/▼** repeatedly until "2 LEVEL" appears, then press **ENTER/SET**.
3. Press **▲/▼** repeatedly until the desired speaker appears.

Display	Description
FRONT L	Front left speaker (-6 to +6)
FRONT R	Front right speaker (-6 to +6)
SURROUND R	Rear right speaker (-6 to +6)
SURROUND L	Rear left speaker (-6 to +6)
SUB WOOFER	Subwoofer (-40 to +6)

4. Press **</>** to adjust the level of each speaker.
5. Press **↶BACK** to move to the previous menu.  
Press **SETUP** to exit the setup menu.

You can adjust speaker level directly by pressing **SPEAKER LEVEL** on the remote control.

### Adjusting the speaker levels

You can adjust the level of each speaker. These settings are applied to all sound fields. You can adjust from - 6 to + 6 (Subwoofer - 40 to + 6).

1. Press **SPEAKER LEVEL** on the remote control and press **▲/▼** repeatedly until the desired speaker appears.  
The display changes cyclically in the display window as follows.  
FRONT L → FRONT R → SURROUND R →  
SURROUND L → SUB WOOFER
2. Press **</>** to adjust the level of each speaker.
3. Repeat and adjust the sound level of the other speakers.

## DISTANCE menu

You can set the distance of the speakers connected to this unit.

1. Press **SETUP**.  
"1 TESTTONE" appears on the display window.
2. Press **▲/▼** repeatedly until "3 DISTANCE" appears, then press **ENTER/SET**.
3. Press **▲/▼** repeatedly until the desired speaker appears.

Display	Description
FRONT L	Front left speaker (0 M to 6.0 M)
FRONT R	Front right speaker (0 M to 6.0 M)
SURROUND R	Rear right speaker (0 M to 6.0 M)
SURROUND L	Rear left speaker (0 M to 6.0 M)
SUB WOOFER	Subwoofer (0 M to 6.0 M)

4. Press **</>** to set the distance of the speakers.
5. Press **↶BACK** to move to the previous menu.  
Press **SETUP** to exit the setup menu.

## A/V SYNC menu (Adjusting the audio delay)

You can delay the sound output using this function when the image is slower than the sound.

1. Press **SETUP**.  
"1 TESTTONE" appears on the display window.
2. Press **▲ / ▼** repeatedly until "4 A/V SYNC" appears, then press **ENTER/SET**.
3. Press **</>** to adjust the delay between sound and image.  
You can adjust from 0 MS to 300 MS in 10 MS steps.
4. Press **↶ BACK** to move to the previous menu. Press **SETUP** to exit the setup menu.

### ! Note

You may not be able to adjust the delay between sound and image perfectly using this function.

## DOLBY DRC menu

This function allows you to listen to a movie at a lower volume without losing clarity of sound. You can compress the dynamic range of the Dolby Digital audio output.

1. Press **SETUP**.  
"1 TESTTONE" appears on the display window.
2. Press **▲ / ▼** repeatedly until "5 DOLBY DRC" appears, then press **ENTER/SET**.
3. Press **</>** to set the DRC.  
- DOLBY DRC OFF : Deactivates this function.  
- DOLBY DRC ON : Activates this function.
4. Press **↶ BACK** to move to the previous menu. Press **SETUP** to exit the setup menu.

### ! Note

Audio dynamic range compression lets you compress the dynamic range of the soundtrack based on the dynamic range information included in the Dolby Digital signal.

## RESET menu

This allows you to initialize settings you have made in the SETUP menu.

1. Press **SETUP**.  
"1 TESTTONE" appears on the display window.
2. Press **▲ / ▼** repeatedly until "6 RESET" appears, then press **ENTER/SET**.  
"1 : YES 2 : NO" appears on the display window.
3. Press the numeric 1 to reset the unit to its original settings.  
If you don't want to reset it, press the numeric 2.
4. Press **↶ BACK** to move to the previous menu. Press **SETUP** to exit the setup menu.

## Selecting the input source

This section explains how to select the input source (i.e., the AUX component that you want to listen).

It is necessary to connect the equipment you want to enjoy such as DVD, Blu-ray disc player, USB etc.

### By using the knob on the unit

1. Press **⏻ / I (STANDBY/ON)** on the unit.
2. Select a source by using **INPUT SELECTION** on the unit. The selected source appears on the display window.

To select	Display (Function)
Component connected to AUX IN 1 jack	AUX 1
Component connected to AUX IN 2 jack	AUX 2
Portable device connected to PORT. IN jack	PORTABLE
Connect Bluetooth device to unit.	BLUETOOTH
LG TV that is supported LG Sound Sync (Wireless)	LG TV
Component connected to HDMI IN 1 jack	HDMI IN 1
Component connected to HDMI IN 2 jack	HDMI IN 2
Component connected to HDMI IN 3 jack	HDMI IN 3
Component connected to OPTICAL IN jack	OPTICAL
FM radio	FM
USB device connected to USB port	USB

### By using the remote control

1. Press **⏻** on the remote control.
2. Select a source by pressing the button on the remote control once or repeatedly.

To select	Button
Component connected to AUX 1/2	<b>AUX</b>
Portable device connected to PORT. IN jack	<b>PORT.IN</b>
Component connected to OPTICAL IN jack	<b>OPTICAL</b>
Component connected to HDMI 1/2/3 jack	<b>HDMI IN</b>
USB device connected to USB port	<b>USB</b>
Bluetooth device connected to unit.	<b>BLUETOOTH</b>
FM radio	<b>RADIO</b>

# USB Operation

## Basic Operations

1. Connect the USB device to the USB port.

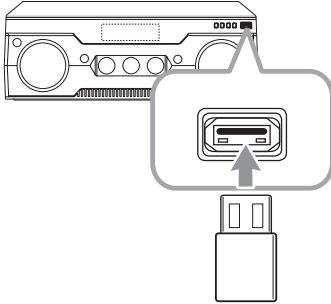

2. Select the USB function by rotating **INPUT SELECTION** on the unit or pressing **USB** on the remote control.

To	Do this
Stop	Press <b>■</b> on the remote control or <b>STOP</b> on the unit.
Playback	Press <b>▶</b> on the remote control or <b>PLAY/PAUSE</b> on the unit.
Pause	Press <b>⏸</b> on the remote control or <b>PLAY/PAUSE</b> on the unit during playback.
Searching for a section within a file	Press <b>◀◀/▶▶</b> on the remote control during playback and release it at the point you want to listen to.
Selecting a file directly	Press <b>0</b> to <b>9</b> numerical buttons on the remote control to go to the desired file directly.
Skipping to the next/previous file	Press <b>⏪/⏩</b> to go to the next file or to return to the beginning of the current file. Press <b>⏪</b> twice briefly to step back to the previous file.

## Selecting a folder and an MP3/WMA file

1. Press **▲/▼** repeatedly until a desired folder appears.
2. Press **▶** to play it. The first file of folder will play.

### Note

- USB Folders/Files are recognized as below.

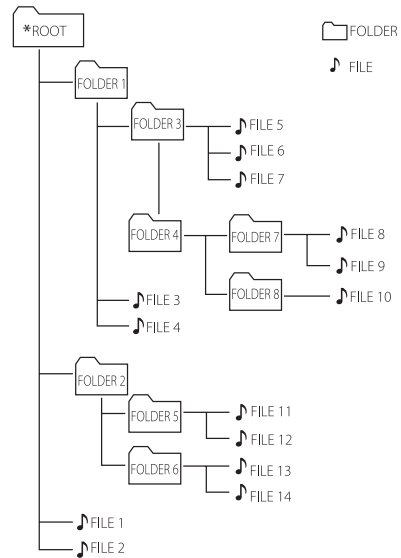

- If there is no file in a folder, the folder will not appear.
- Folders will be presented as the following order, ROOT → FOLDER 1 → FOLDER 3 → FOLDER 7 → FOLDER 8 → FOLDER 5 → FOLDER 6
- File will be played from **♪** file No.1 to **♪** file No.14 one by one.
- Files and folders will be presented in order recorded and may be presented differently according to the record circumstances.
- \*ROOT : The first screen you can see when a computer recognize the USB is "ROOT"

## Deleting an MP3/WMA file

You can delete file, folder or format by pressing **DELETE**. This function is supported only in stop status. (USB only)

1. -Select the file or folder you want to delete and press **DELETE**.  
-Press and hold **DELETE** to format the USB device.

Or

Press **DELETE** repeatedly during selecting the MP3/WMA file.

The display changes in the following order:

- DEL FILE? : Deletes file
- DEL FOLDER? : Deletes folder
- FORMAT? : Formats USB

2. To delete file/folder or format, press ►.
3. If you want to exit the current mode, press ■.

### Caution

- Do not extract the USB device during operation. (play, delete, etc.)
- Regular back up is recommended to prevent data loss.
- The delete function may not be supported according to the USB status. (lock, etc.)

## Playing repeatedly or randomly

During playback, press  **REPEAT** repeatedly to select a desired mode.

Display	Description
REPEAT TRK	The current file will be played repeatedly.
REPEAT DIR	All the files in Directory will be played repeatedly.
REPEAT ALL	All the files in device will be played repeatedly.
RANDOM	The files will be played in random order.
OFF	Returns to normal playback.

## To activate the mute function

Press  on the remote control. "X" appears on the display window.

To cancel, press  on the remote control again or change the volume level by using **VOL -/+** on the remote or rotating **MASTER VOLUME** on the front panel.

## Playable file Requirement

### Music file requirement

MP3/WMA file compatibility with this unit is limited as follows.

- Sampling frequency : within 32 to 48 kHz (MP3), within 32 to 48 kHz (WMA)
- Bit rate : within 32 to 320 kbps (MP3), 40 to 192 kbps (WMA)
- Maximum files : Under 2000
- Maximum folders : Under 200
- File extensions : "mp3"/ "wma"

### Compatible USB Devices

- MP3 Player : Flash type MP3 player.
- USB Flash Drive :  
Devices that support USB2.0 or USB1.1.
- The USB function of this unit does not support all USB devices.

### USB device requirement

- Devices which require additional program installation when you have connected it to a computer, are not supported.
- Do not extract the USB device while in operation.
- For a large capacity USB, it may take longer than a few minute to be searched.
- To prevent data loss, back up all data.
- If you use a USB extension cable or USB hub, the USB device is not recognized.
- Using NTFS file system is not supported. (Only FAT (16/32) file system is supported.)
- External HDD, Card readers, Locked devices, or hard type USB devices are not supported.
- USB port of the unit cannot be connected to PC. The unit cannot be used as a storage device.
- Some USB may not work with this unit.

## Playback effect

The unit supports various sound and playback effects : DJ PRO, AUTO DJ, DJ EFFECT, and JUKE BOX playback.

### DJ PRO

It allows you to mix CLUB, DRUM or SCRATCH sound effect. CLUB and DRUM have up to 6 sounds effect.

Turn **DJ PRO** clockwise or counterclockwise to select a desired DJ PRO sound effect.

And then, turn **CONTROL** clockwise or counterclockwise.

#### Note

- Initial DJ PRO mode is DJ PRO OFF.
- DJ PRO mode is displayed for 3 seconds when you rotate **DJ PRO (CLUB, DRUM or SCRATCH)**.
- The currently playing DJ PRO sound is stopped and the selected DJ PRO sound outputs if you select a different **DJ PRO** sound effect while DJ PRO sound is playing.
- The functions supported by DJ PRO are RADIO, USB, AUX1/2, PORTABLE, BLUETOOTH, and LG TV.
- You can hear effect of scratch sound depending on the direction in which you rotate **CONTROL**.

## DJ EFFECT

It allows you to enjoy DJ EFFECT such as FLANGER/ PHASER/WAH/DELAY sound effect.

1. Press **DJ EFFECT** to select a desired DJ EFFECT (FLANGER, PHASER, WAH, DELAY, OFF).
2. Turn **CONTROL** clockwise or counterclockwise to adjust the DJ EFFECT level between 0 to 15.

You can also adjust the DJ EFFECT level by pressing **</>** on the remote control.

### Note

- The DJ EFFECT mode is displayed for 3 seconds when a **DJ EFFECT** Key is inputted.
- The current gage level is displayed when adjusting gage.
- If the function changed or the unit is turned off and on, DJ EFFECT mode with DJ EFFECT is turned off.

## AUTO DJ playback

Auto DJ blends the end of one song into the beginning of another for seamless playback. It equalizes volume across files for uninterrupted playback.

Press **AUTO DJ** on the remote control repeatedly, the display changes as followings. RANDOM (AUTO DJ RANDOM) -> REPEAT ALL (AUTO DJ SEQUENTIAL) -> (AUTO DJ OFF)

Mode	Display Window	Description
OFF	- (AUTO DJ OFF)	-
RANDOM	RANDOM (AUTO DJ RANDOM)	The music is played randomly on this mode.
REPEAT	REPEAT ALL (AUTO DJ SEQUENTIAL)	The music is played repeatedly on this mode.

### Note

- It is not supported on the AUTO DJ mode to search for a section within a file or to play repeatedly or randomly.
- If you move to other functions or stop the music using **STOP** on the unit (or **■** on the remote control) on AUTO DJ mode, AUTO DJ function will be disable.
- AUTO DJ function is not supported in the music file whose length is less than 60 seconds.
- Only AUTO DJ SEQUENTIAL is selected when played JUKE BOX list.
- You can only use AUTO DJ playback when using USB playback.

## JUKE BOX Playback (Program play)

JUKE BOX function enables you to make a playlist of your favorite files from a USB device. A playlist of up to 100 files can be entered.

### Making JUKE BOX list

It is supported only on stop status.

1. Press and hold **JUKE BOX** to enter the edit mode.
2. Select a file by pressing **◀◀/▶▶** on the remote control.
3. Press **JUKE BOX** to save the file.
4. Repeat 2 to 3 to store the other files.  
(You can modify the list by pressing **▲/▼** to select the **JUKE BOX** program number.)
5. Press **JUKE BOX** once again.

To play the JUKE BOX list, press **▶** after you make the list.

### Enjoying JUKE BOX

Press **JUKE BOX** twice on stop status. "JUKE BOX ON" appears on the display window. To play JUKE BOX list, press **▶** on the remote control or **PLAY/ PAUSE** on the unit.

To cancel it, press **JUKE BOX** twice. "JUKE BOX OFF" appears on the display window.

### Deleting JUKE BOX list

Deleting function is worked only on the edit mode. Refer to "Making JUKE BOX list" step 1.

1. Select a song by pressing **JUKE BOX** repeatedly or pressing **▲/▼**.
2. Press **DELETE** while a song is selected.

#### Note

- To check the status of JUKE BOX, press **JUKE BOX** once. You can also check it by the word "PROG." on the display window.
- If there is no JUKE BOX list, "JUKE BOX NONE" appears on the display window when you press **JUKE BOX**.
- JUKE BOX is switched off in the case below.
  - Changing the function to the others.
  - Turning off and on the unit.
  - Operating the numeric buttons on the remote control.
- JUKE BOX list is cleared in the case below.
  - Removing the USB device.
  - Deleting or recording music files in the USB device.
- You can only use JUKE BOX playback when using USB playback.

## Enjoying various sound mode

You can enjoy various sound mode. For details, refer to "Setting the USER EQ", "Sound effect" and "Bass Blast".

### Setting the USER EQ

You can listen to music with desired sound effect by adjusting the BASS, MIDDLE and TREBLE.

1. Press **USER EQ** on the front panel.  
"USER EQ" appears on the display window.
2. Press **ENTER** on the front panel while the "USER EQ" is displayed in the display window.
3. Select the BASS, MIDDLE or TREBLE by pressing **PLAY/PAUSE** on the front panel.
4. Rotate **CONTROL** on the front panel to set sound level.
5. Press **ENTER** on the front panel to finish the settings.

### Sound effect

This system has a number of preset sound effects. You can select a suitable sound effect. Press **SOUND EFFECT** on the remote control or rotate **SOUND EFFECT** on the front repeatedly until the desired sound effect appears on the display window.

Display	Description
Local specialization equalizer	Regionally optimized sound effect. (ARABIC/ PERSIAN/ INDIA/ AFRO(AFRO Hip Hop))
MUSIC	You can enjoy comfortable and natural sound.
CINEMA	You can enjoy more immersive and cinematic surround sound.
POP CLASSIC JAZZ ROCK	This program lends an enthusiastic atmosphere to the sound, giving you the feeling you are at an actual pop, classic, jazz or rock concert.
VOICE	This mode makes voice sound clear, improving the quality of voice sound.
BASS BLAST	During playback, reinforces the bass sound.
FOOTBALL	You can enjoy the sound effect FOOTBALL STADIUM.
STANDARD	You can enjoy optimized sound.

#### ! Note

- In some of surround modes, some speakers, there's no sound or low sound. It depends on the mode of surround and the source of audio, it is not defective.
- By pressing BASS BLAST you can directly select BASS BLAST effect.

## LG Sound Sync



You can control some functions of this unit by your TV's remote control with LG Sound Sync. It is compatible with the LG TV that is supported LG Sound Sync. Make sure of the LG Sound Sync logo on your TV.

Controllable function by LG TV's remote control :  
Volume up/down, mute

Refer to the TV's instruction manual for the details of LG Sound Sync.

### ! Note

- You can also use the remote control of this unit while using LG Sound Sync. If you use TV's remote control again, the unit synchronizes with the TV.
- If the connection fails, check the conditions of this unit and your TV : power, function.
- Make sure of the condition of this unit and the connection in the cases below when using LG Sound Sync.
  - Turn off the unit.
  - Changing the function to the others.
  - Disconnecting the wireless connection caused by interference or a distance.
- The amount of time to turn off this unit is different depending on your TV when you set AUTO POWER function to ON.
- Details of TV setting menu vary depending on the models of your TV.
- If you connect LG Sound Sync when "Music Flow Bluetooth" app is connected, control through the app is available.
- If an LG TV is connected when using Bluetooth, Bluetooth is disconnected and the LG TV is connected.
- The volume may be increased when the TV and this unit is connected by LG Sound Sync.

## With wireless connection

1. Turn on the unit by pressing (Power) on the remote control.
2. Select the input source to LG TV by pressing **FUNCTION** button repeatedly.
3. Set up the sound output of TV to listen to the sound through this unit :  
TV setting menu → [Sound] → [TV Sound output] → [LG Sound Sync (Wireless)]

When the TV is not connected, "LG TV READY" appears on the display window. If the TV and this unit are connected normally, "LG TV PAIRED" will be appear on the display window.

### ! Note

If you turned off the unit directly by pressing (Power), LG Sound Sync (Wireless) will be disconnected. To use this function again, you should reconnect the TV and the unit.

## Using a BLUETOOTH® wireless technology

### About Bluetooth

**Bluetooth** is wireless communication technology for short range connection.

The sound may be interrupted when the connection interfered by the other electronic wave or you connect the **Bluetooth** in the other rooms.

Connecting individual devices under **Bluetooth** wireless technology does not incur any charges. A mobile phone with **Bluetooth** wireless technology can be operated via the Cascade if the connection was made via **Bluetooth** wireless technology.  
Available Devices : Mobile phone, MP3, Laptop, PDA.

### Bluetooth Profiles

In order to use **Bluetooth** wireless technology, devices must be able to interpret certain profiles. This unit is compatible with following profile.

A2DP (Advanced Audio Distribution Profile)

Codec : SBC

4

Operating

## Listening to music stored on the Bluetooth devices

Before you start the pairing procedure, make sure the Bluetooth feature is turned on in to your **Bluetooth** device. Refer to your **Bluetooth** device's user guide. Once a pairing operation is performed, it does not need to be performed again.

1. Turn on the unit.
2. Operate the **Bluetooth** device and perform the pairing operation. When searching for this unit with the **Bluetooth** device, a list of the devices found may appear in the **Bluetooth** device display depending on the type of **Bluetooth** device. Your unit appears as "LG ARX5(XX)".

### ! Note

- XX means the last two digits of **Bluetooth** address. For example, if your unit has a **Bluetooth** address such as 9C:02:98:4A:F7:08, you will see "LG ARX5(08)" on your **Bluetooth** device.
- Depending on the **Bluetooth** device type, some device have a different pairing way. Enter the PIN code (0000) as needed.
- You can connect this unit with up to 3 **Bluetooth** device simultaneously same method as above description.
- The multi pairing connection is only supported on Android devices. (Multi pairing connection may not be supported depending on the connected device specifications.)
- Removable/detachable **Bluetooth** device (Ex : Dongle etc..) doesn't supported multi pairing.

3. When this unit is successfully connected with your **Bluetooth** device, "BLUETOOTH PAIRED" appears on the display window and change to **Bluetooth** device name soon.

### ! Note

- "BLUETOOTH PAIRED" will momentarily appear on the display when you connect other devices for multi pairing.
- If the device name is unavailable, "\_" will be displayed.

## 4. Listen to music.

To play a music stored on your **Bluetooth** device, refer to your **Bluetooth** device's user guide.

### ! Note

- When using **Bluetooth**® technology, you have to make a connection between the unit and the **Bluetooth** device as close as possible and keep the distance. However it may not work well in the case below :
  - There is a obstacle between the unit and the **Bluetooth** device.
  - There is a device using same frequency with **Bluetooth**® technology such as a medical equipment, a microwave or a wireless LAN device.
- You should connect your **Bluetooth** device to this unit again when you restart it.
- Even if this unit connected up to 3 **Bluetooth** devices, you can play and control music by using only one of the connected devices.
- When this unit connected with multiple **Bluetooth** devices, only one device which you are playing keeps **Bluetooth** connection when you change the function to the others.
- The sound may be interrupted when the connection has interference from other electronic devices.

### ! Note

- You may not control the **Bluetooth** device with this unit.
- Depending on the type of the device, you may not be able to use the Bluetooth function.
- You can enjoy wireless system using phone, MP3, Notebook, etc..
- The more distance between the unit and the **Bluetooth** device, the lower the sound quality becomes.
- **Bluetooth** connection will be disconnected when the unit is turned off or the **Bluetooth** device gets far from the unit.
- When **Bluetooth** connection is disconnected, connect the **Bluetooth** device to the unit again.
- When not connected the **Bluetooth**, "BLUETOOTH" and "BLUETOOTH READY" appears on the control panel.
- When you use the BT function, adjust the volume to a proper level on the **Bluetooth** device.
- If it is not in the BT function, only one device can be connected.
- If a **Bluetooth** device is connected when using LG TV, LG TV is disconnected and the **Bluetooth** device is connected.
- When you connect **Bluetooth** device (iOS device etc.) to this unit or operate the device, the volume level can be synchronized with each other.

## Using the Music Flow Bluetooth App

### ! Note

Only Android OS is available to use "Music Flow Bluetooth" app with this unit.

### About "Music Flow Bluetooth" App

"Music Flow Bluetooth" app brings a suite of new features to this unit.

To enjoy more features, you are recommended to download and install free "Music Flow Bluetooth" app.

### Install "Music Flow Bluetooth" App onto Your Bluetooth Device

1. Install "Music Flow Bluetooth" app through QR code. Use the scanning software to scan the QR code.



2. Tap an icon for installation.
3. Tap an icon for downloading.

### ! Note

- Make sure that your **Bluetooth** device is connected to the Internet.
- Make sure that your **Bluetooth** device has a scanning software application. If you don't have one, download one from "Google Android Market (Google Play Store)".
- Depending on the area, QR code may not work.

### Install "Music Flow Bluetooth" App through "Google Android Market (Google Play Store)"

1. Tap the "Google Android Market (Google Play Store)" icon.
2. In the search bar, type in the "Music Flow Bluetooth" and search it.
3. In the search result list, find and tap "Music Flow Bluetooth" to start downloading **Bluetooth** app.
4. Tap an icon for installation.
5. Tap an icon for downloading.

### ! Note

- Make sure that your **Bluetooth** device is connected to the Internet.
- Make sure that your **Bluetooth** device is equipped with "Google Android Market (Google Play Store)".

## Activate Bluetooth with “Music Flow Bluetooth” App

“Music Flow Bluetooth” app helps to connect your **Bluetooth** device to this unit.

1. Tap “Music Flow Bluetooth” app icon on the home screen to open “Music Flow Bluetooth” app, and go to the main menu.
2. Tap [Setting] and select the unit you want.
3. If you want to get more information to operate, tap [Setting] and [Help].

### Note

- “Music Flow Bluetooth” app will be available in the software version as follow;
  - Android O/S : Ver 4.0.3 (or later)
- If you use “Music Flow Bluetooth” app for operation, there would be some differences between “Music Flow Bluetooth” app and the supplied remote control. Use the supplied remote control as necessary.
- Depending on the **Bluetooth** device, “Music Flow Bluetooth” app may not work.
- After connection of “Music Flow Bluetooth” app, music may be output from your device. In this case, try connecting procedure again.
- If you operate the other applications or change the settings on your **Bluetooth** device while using “Music Flow Bluetooth” app, “Music Flow Bluetooth” app may operate abnormally.
- When “Music Flow Bluetooth” app operates abnormally, check your **Bluetooth** device and the connection of “Music Flow Bluetooth” app and then try to connect again.
- Depending on the smart phone's operating system, you have some differences for “Music Flow Bluetooth” operation.
- Check **Bluetooth** setting on your **Bluetooth** device if “Music Flow Bluetooth” app connection does not work well.

## Radio Operations

Be sure that FM antenna is connected. (Refer to the page 20.)

### Listening to FM radio

1. Press **RADIO** on the remote control or turn **INPUT SELECTION** on the unit until FM appears on the display window.

The last received station is tuned in.

2. Auto tuning :  
Press and hold **TUNING -/+** for about 2 seconds until the frequency indication starts to change, then release. Scanning stops when the unit tunes in a station.

Manual tuning :

Press **TUNING -/+** on the remote control repeatedly.

3. Adjust the volume by pressing **VOL+/-** on the remote control or turn **MASTER VOLUME** on the unit.

### Improving poor FM reception

Press **MONO/STEREO** on the remote control. This will change the tuner from stereo to mono and usually improve the reception.

### Presetting the Radio Stations

You can preset 50 stations for FM.

Before tuning, make sure to turn down the volume.

1. Tune in to a radio station.
2. Press **ENTER/SET**. A preset number will blink in the display window.
3. Press **PRESET/FOLDER +/-** to select the preset number you want.
4. Press **ENTER/SET**. The station is stored.
5. Repeat steps 1 to 4 to store the other stations.
6. To listen to a preset station, press **PRESET/FOLDER +/-** or 0 to 9 numerical buttons.

### Deleting all the saved stations

1. Press and hold **DELETE** for two seconds. "ERASE ALL?" will flash up on the unit display.
2. Press **ENTER** to erase all the saved radio stations.

## Other Operations

### Dimmer

Press **SLEEP** once. The display window is darkened by half and the lighting is turned off. To cancel it, press **SLEEP** repeatedly until dim off.

### Using the Sleep Timer

You can set the unit to turn off automatically at a specified time. Press **SLEEP** repeatedly.

The indicator changes cyclically in the display window as follows.

SLEEP 180 -> 150 -> 120 -> 90 -> 80 -> 70 -> 60 -> 50 -> 40 -> 30 -> 20 -> 10 -> Off (No display)

To check the remaining time, press **SLEEP**. The remaining time appears on the display window.

To cancel the sleep function, press **SLEEP** repeatedly until "SLEEP 10" appears, and then press **SLEEP** once again while "SLEEP 10" is displayed.

#### Note

When the sleep timer is activated, the display window dims and the lighting is turned off.

### Displaying file and input source

You can display various information of the input source by pressing **INFORMATION**.

Function	Description
AUX 1/2, PORTABLE	Displays the audio format. (ex : ANALOG)
BLUETOOTH	Sees the name of connected all Bluetooth device in Bluetooth mode.
HDMI IN 1/2/3, OPTICAL	Displays the audio format and audio channel. (ex : PCM2/0.0, Dolby D 3/2.1, etc.)
USB	Displays the file information during MP3/WMA playback and audio channel. (ex : FILE-XXXXXX)

### Auto power down

This unit will be off itself to save electric consumption in the case main unit is not connected to external device and is not used for 20 minutes.

So does this unit after six hours since Main unit has been connected to other device using analog input.

### AUTO POWER On/Off

This unit automatically turns on by an input source : Optical, LG TV or **Bluetooth**.

When you turn on your TV or an external device connected to this unit, this unit recognizes the input signal and select the suitable function. You can hear the sound from your device.

If you try to connect your **Bluetooth** device, this unit turns on and ready to pair. Connect your **Bluetooth** device and play your music.

This function turns on or off each time you press **AUTO POWER**.

#### Note

- After the unit is turned on by AUTO POWER function, it will be automatically turned off if there is no signal for a certain period of time from the TV connected by LG Sound Sync (Wireless).
- After the unit is turned on by AUTO POWER function, it will be automatically turned off if there is no signal for a certain period of time from the external device.
- If you turned off the unit directly, it cannot be turned on automatically by AUTO POWER function. However the unit can be turned on by AUTO POWER function when optical signal comes in after 5 seconds of no signal.
- Depending on the connected device, this function may not operate.
- If you disconnect **Bluetooth** connection by this unit, some **Bluetooth** devices try to connect to the unit continually. Therefore it is recommended to disconnect the connection before turn off the unit.
- When you turn on this unit for the first time, Auto Power function is turned on status.

# Advanced Operations

## Recording to USB

You can record a various sound source to USB. (AUX1/2 ,PORTABLE, FM)

1. Connect the USB device to the unit.
2. Select a function in which you want to record by using **INPUT SELECTION** on the unit or **FUNCTION** on the remote control.
3. Press **●REC** on the remote control.
4. To stop recording, press **STOP** on the unit or **●REC** on the remote control.

## Pausing recording

During recording, press **PLAY/PAUSE** on the unit or **II** on the remote control to pause recording.



Press **PLAY/PAUSE** on the unit or **▶** on the remote control to restart recording.

## To select recording bit rate

1. Press **●REC** on the remote control for longer than 3 seconds.
2. Press **◀◀/▶▶** on the remote control to select a bit rate.
3. Press **●REC** on the remote control again to finish the setting.

## Note

- It is not supported to record music stored on Bluetooth, HDMI IN and OPTICAL IN sources.
- When you stop recording during playback, the file that has been recorded at that time will be stored.
- Do not remove the USB device or turn off the unit during USB recording. If does not, an incomplete file may be made and not deleted on PC.
- If USB recording does not work, the message like "NO USB", "ERROR", "USB FULL", "NOT SUPPORT", "FILE MAX" is displayed on the display window.
- Multi card reader device or External HDD can not be used for USB recording.
- A file is recorded by about 512 Mbyte when you record for a long term.
- You may not store more than 2000 files.
- You can check recording elapsed time by pressing **INFORMATION** button on the remote control.
- It'll be stored as follows.

Tuner	The other source*
 TUNER_REC   AUDIO_0001_87-50FM   AUDIO_0002_87-60FM   ⋮	 OTHERS_REC   AUDIO_0001   AUDIO_0002   ⋮

- TUNER : The current recording frequency is shown.

- \*: PORTABLE and the like.

- You can record various sound using DJ Pro/ Scratch/DJ Effect/Original Source.

The making of unauthorized copies of copy-protected material, including computer programs, files, broadcasts and sound recordings, may be an infringement of copyrights and constitute a criminal offense.

This equipment should not be used for such purposes.

**Be responsible**  
**Respect copyrights**

# Troubleshooting

PROBLEM	CAUSE & CORRECTION
The unit does not work properly.	<ul style="list-style-type: none"> <li>• Turn off the power of this unit and the connected external device (TV, Woofer, DVD-player, Amplifier, etc.) and turn it on again.</li> <li>• Disconnect the power cord of this unit and the connected external device (TV, Woofer, DVD-player, Amplifier, etc.) and then try connecting again.</li> </ul>
No Power	<ul style="list-style-type: none"> <li>• The power cord is unplugged. Plug in the power cord.</li> <li>• Check the condition by operating other electronic devices.</li> </ul>
No sound	<ul style="list-style-type: none"> <li>• The speaker wires are disconnected. Check the speaker connections.</li> <li>• The volume is set to minimum. Adjust the volume level.</li> <li>• Incorrect input source is selected. Check the input source and select the correct input source.</li> <li>• The mute function is activated. Press  or adjust the volume level to cancel the mute function.</li> </ul>
Radio stations cannot be tuned in properly.	<ul style="list-style-type: none"> <li>• The antenna is positioned poorly. Adjust its position.</li> <li>• The signal strength of the radio station is too weak. Tune to the station manually.</li> <li>• No stations have been preset or preset stations have been cleared (when tuning by scanning preset channels). Preset some radio stations, see page 36 for details.</li> </ul>
The remote control does not work properly.	<ul style="list-style-type: none"> <li>• The remote control is too far from the unit. Operate the remote control within about 23 ft (7 m).</li> <li>• There is an obstacle in the path of the remote control and the unit. Remove the obstacle.</li> <li>• The batteries in the remote control are exhausted. Replace the batteries with new one.</li> </ul>

## Controlling a TV with the Supplied Remote Control

You can control your TV using the buttons below.

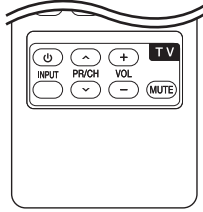

By pressing	You can
(TV POWER)	Turn the TV on or off.
INPUT	Switch the TV's input source between the TV and other input sources.
PR/CH $\wedge$ / $\vee$	Scan up or down through memorized channels.
VOL +/-	Adjust the volume of the TV
MUTE	Turn the TV's volume on or off.

### Note

Depending on the unit being connected, you may not be able to control your TV using some of the buttons.

## Setting up the remote to control your TV

You can operate your TV with the supplied remote control.

If your TV is listed in the table below, set the appropriate manufacturer code.

1. While holding down (TV POWER) button, and press the manufacturer code for your TV with the numerical buttons (see the table below).

Manufacturer	Code number
LG	1(Default), 2
Zenith	1, 3, 4
GoldStar	1, 2
Samsung	6, 7
Sony	8, 9
Hitachi	4

2. Release the (TV POWER) button to complete setting.

Depending on your TV, some or all buttons may not function on the TV, even after entering the correct manufacturer code. When you replace the batteries of the remote, the code number you have set may be reset to the default setting. Set the appropriate code number again.

## Trademarks and licenses



The terms HDMI and HDMI High-Definition Multimedia Interface, and the HDMI logo are trademarks or registered trademarks of HDMI Licensing LLC in the United States and other countries.



Manufactured under license from Dolby Laboratories. Dolby, Dolby Audio, and the double-D symbol are Trademarks of Dolby Laboratories.



The **Bluetooth**® word mark and logos are registered trademarks owned by the **Bluetooth** SIG, Inc. and any use of such marks by LG Electronics is under license.

Other trademarks and trade names are those of their respective owners

## Maintenance

### Handling the unit

#### When shipping the unit

Please save the original shipping carton and packing materials. If you need to ship the unit, for maximum protection, re-pack the unit as it was originally packed at the factory.

#### Keeping the exterior surfaces clean

- Do not use volatile liquids such as insecticide spray near the unit.
- Wiping with strong pressure may damage the surface.
- Do not leave rubber or plastic products in contact with the unit for a long period of time.

#### Cleaning the unit

To clean the player, use a soft, dry cloth. If the surfaces are extremely dirty, use a soft cloth lightly moistened with a mild detergent solution. Do not use strong solvents such as alcohol, benzine, or thinner, as these might damage the surface of the unit.

## Specifications

General	
Power requirements	Refer to the main label.
Power consumption	Refer to the main label.
Dimensions (W x H x D)	(430 x 146.5 x 368) mm
Net Weight (Approx.)	4.7 kg
Operating temperature	41 °F to 95 °F (5 °C to 35 °C)
Operating humidity	5 % to 90 %
Bus Power Supply	5 V  500 mA
Available Digital Input Audio Sampling Frequency	32 kHz, 44.1 kHz, 48 kHz, 96 kHz
Available Digital Input Audio format	Dolby Digital, PCM
Available Music File format	MP3, WMA

Input/Output	
ANALOG AUDIO IN	2.0 Vrms (1 kHz, 0 dB), 600 $\Omega$ , RCA jack (L, R) x 2
ANALOG VIDEO IN	1.0 Vrms (p-p), 75 $\Omega$ , sync negative, RCA jack x 1
OPTICAL IN	3.0 Vrms (p-p), Optical jack x 1
PORT. IN	0.5 Vrms ( $\varnothing$ 3.5 mm stereo jack) x 1
HDMI IN/OUT	19 pin (Type A, HDMI™ connector)
AUDIO OUT	2.0 Vrms (1 kHz, 0 dB), 600 $\Omega$ , RCA jack (L, R) x 1
VIDEO OUT	1.0 Vrms (p-p), 75 $\Omega$ , sync negative, RCA jack x 1

Tuner	
FM Tuning Range	87.5 MHz to 108.0 MHz or 87.50 MHz to 108.00 MHz

Amplifier (RMS output power)		
Stereo mode	167 W (3 $\Omega$ at 1 kHz) x 2	
Surround mode	Front	167 W (3 $\Omega$ at 1 kHz) x 2
	Rear	167 W (3 $\Omega$ at 1 kHz) x 2
	Sub woofer	167 W (3 $\Omega$ at 70 Hz) x 2

Front speakers/Rear speakers	
Type	1 Way 1 Speaker
Impedance	3 $\Omega$
Rated Input Power	167 W x 2
Max. Input Power	334 W x 2
Net Dimensions (W x H x D)	(88 x 122 x 81) mm
Net Weight (1EA)	0.5 kg

Subwoofer	
Type	1 Way 1 Speaker
Impedance	3 $\Omega$
Rated Input Power	167 W x 2
Max. Input Power	334 W x 2
Net Dimensions (W x H x D)	(191 X 388.5 X 318) mm
Net Weight(1EA)	5.0 kg

- Designs and specifications are subject to change without prior notice.

