



INSTALLATION MANUAL

AIR CONDITIONER

Please read this installation manual completely before installing the product.
Installation work must be performed in accordance with the national wiring standards by authorized personnel only.

Please retain this installation manual for future reference after reading it thoroughly.

4-WAY CEILING CASSETTE
Original instruction

For more information, Refer to the CD or LG Web site (www.lg.com).



MFL67855527
Rev.01_031825

Copyright © 2016 - 2025 LG Electronics Inc. All Rights Reserved.

www.lg.com

ENGLISH

ITALIANO

ESPAÑOL

FRANÇAIS

DEUTSCH

ΕΛΛΗΝΙΚΑ

ČEŠTINA

NETERLANDS

POLSKI

LIMBA ROMÂNĂ

MODEL DESIGNATION

Product information

- Product Name : Air conditioner

- Model Name :

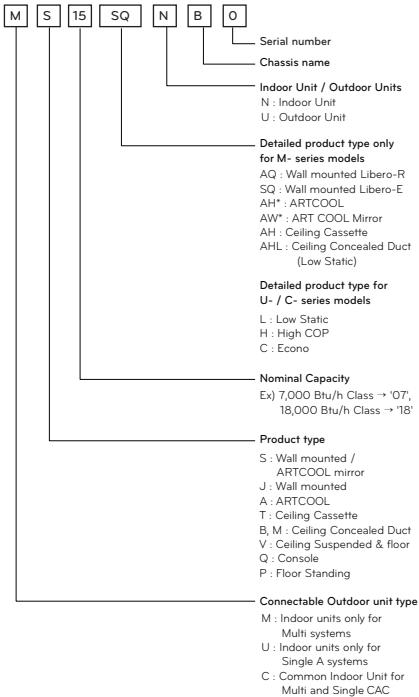

- Additional Information : serial number is refer to the barcode on the product.

- Max allowable pressure High side : 4.2 MPa / Low side : 2.4 MPa

- Refrigerant : R410A

Airborne Noise Emission

The A-weighted sound pressure emitted by this product is below 70 dB.

** The noise level can vary depending on the site.

The figures quoted are emission level and are not necessarily safe working levels.

Whilst there is a correlation between the emission and exposure levels, this cannot be used reliably to determine whether or not further precautions are required.

Factor that influence the actual level of exposure of the workforce include the characteristics of the work room and the other sources of noise, i.e. the number of equipment and other adjacent processes and the length of time for which an operator exposed to the noise. Also, the permissible exposure level can vary from country to country.

This information, however, will enable the user of the equipment to make a better evaluation of the hazard and risk.

Limiting concentration

Limiting concentration is the limit of Freon gas concentration where immediate measures can be taken without hurting human body when refrigerant leaks in the air. The limiting concentration shall be described in the unit of kg/m^3 (Freon gas weight per unit air volume) for facilitating calculation

Limiting concentration: $0.44\text{kg}/\text{m}^3(\text{R410A})$

■ Calculate refrigerant concentration

$$\text{Refrigerant concentration (kg/m}^3\text{)} = \frac{\text{Total amount of replenished refrigerant in refrigerant facility (kg)}}{\text{Capacity of smallest room where indoor unit is installed (m}^3\text{)}}$$

TIPS FOR SAVING ENERGY

Here are some tips that will help you minimize the power consumption when you use the air conditioner. You can use your air conditioner more efficiently by referring to the instructions below:

- Do not cool excessively indoors. This may be harmful for your health and may consume more electricity.
- Block sunlight with blinds or curtains while you are operating the air conditioner.
- Keep doors or windows closed tightly while you are operating the air conditioner.
- Adjust the direction of the air flow vertically or horizontally to circulate indoor air.
- Speed up the fan to cool or warm indoor air quickly, in a short period of time.
- Open windows regularly for ventilation as the indoor air quality may deteriorate if the air conditioner is used for many hours.
- Clean the air filter once every 2 weeks. Dust and impurities collected in the air filter may block the air flow or weaken the cooling / dehumidifying functions.

For your records

Staple your receipt to this page in case you need it to prove the date of purchase or for warranty purposes.

Write the model number and the serial number here:

Model number : _____

Serial number : _____

You can find them on a label on the side of each unit.

Dealer's name : _____

Date of purchase : _____

IMPORTANT SAFETY INSTRUCTIONS

READ ALL INSTRUCTIONS BEFORE USING THE APPLIANCE.

Always comply with the following precautions to avoid dangerous situations and ensure peak performance of your product

⚠ WARNING

It can result in serious injury or death when the directions are ignored

⚠ CAUTION

It can result in minor injury or product damage when the directions are ignored

⚠ WARNING

- Installation or repairs made by unqualified persons can result in hazards to you and others.
- Installation **MUST** conform with local building codes or, in the absence of local codes, with the Nation Electrical Code NFPA 70/ANSI C1-1003 or current edition and Canadian Electrical Code Part1 CSA C.22.1.
- The information contained in the manual is intended for use by a qualified service technician familiar with safety procedures and equipped with the proper tools and test instruments.
- Failure to carefully read and follow all instructions in this manual can result in equipment malfunction, property damage, personal injury and/or death.

Installation

- Always perform grounding. - Otherwise, it may cause electrical shock.
- Don't use a power cord, a plug or a loose socket which is damaged. - Otherwise, it may cause a fire or electrical shock.

- For installation of the product, always contact the service center or a professional installation agency. - Otherwise, it may cause a fire, electrical shock, explosion or injury.
- Securely attach the electrical part cover to the indoor unit and the service panel to the outdoor unit.
 - If the electrical part cover of the indoor unit and the service panel of the outdoor unit are not attached securely, it could result in a fire or electric shock due to dust, water, etc.
- Always install an air leakage breaker and a dedicated switching board. - No installation may cause a fire and electrical shock.
- Do not keep or use flammable gases or combustibles near the air conditioner. - Otherwise, it may cause a fire or the failure of product.
- Ensure that an installation frame of the outdoor unit is not damaged due to use for a long time.
 - It may cause injury or an accident.
- Do not disassemble or repair the product randomly. - It will cause a fire or electrical shock.
- Do not install the product at a place that there is concern of falling down. - Otherwise, it may result in personal injury.
- Use caution when unpacking and installing. - Sharp edges may cause injury.

Operation

- Do not share the outlet with other appliances. - It will cause an electric shock or a fire due to heat generation.
- Do not use the damaged power cord. - Otherwise, it may cause a fire or electrical shock.
- Do not modify or extend the power cord randomly.
 - Otherwise, it may cause a fire or electrical shock.
- Take care so that the power cord may not be pulled during operation. - Otherwise, it may cause a fire or electrical shock.
- Unplug the unit if strange sounds, smell, or smoke comes from it. - Otherwise, it may cause electrical shock or a fire.
- Keep the flames away. - Otherwise, it may cause a fire.

- Take the power plug out if necessary, holding the head of the plug and do not touch it with wet hands. - Otherwise, it may cause a fire or electrical shock.
- Do not use the power cord near the heating tools. - Otherwise, it may cause a fire and electrical shock.
- Do not open the suction inlet of the indoor/outdoor unit during operation. - Otherwise, it may electrical shock and failure.
- Do not allow water to run into electrical parts. - Otherwise, it may cause the failure of machine or electrical shock.
- Hold the plug by the head when taking it out. - It may cause electric shock and damage.
- Never touch the metal parts of the unit when removing the filter. - They are sharp and may cause injury.
- Do not step on the indoor/outdoor unit and do not put anything on it. - It may cause an injury through dropping of the unit or falling down.
- Do not place a heavy object on the power cord. - Otherwise, it may cause a fire or electrical shock.
- When the product is submerged into water, always contact the service center. - Otherwise, it may cause a fire or electrical shock.
- Take care so that children may not step on the outdoor unit. - Otherwise, children may be seriously injured due to falling down.
- Use a vacuum pump or inert (nitrogen) gas when doing leakage test or air purge. Do not compress air or oxygen, and do not use flammable gases. Otherwise, it may cause fire or explosion. - There is the risk of death, injury, fire or explosion.
- Do not turn on the breaker or power under condition that front panel, cabinet, top cover, control box cover are removed or opened. - Otherwise, it may cause fire, electric shock, explosion or death.

CAUTION

Installation

- Install the drain hose to ensure that drain can be securely done. - Otherwise, it may cause water leakage.
- Install the product so that the noise or hot wind from the outdoor unit may not cause any damage to the neighbors. - Otherwise, it may cause dispute with the neighbors.
- Always inspect gas leakage after the installation and repair of product. - Otherwise, it may cause the failure of product.
- Keep level parallel in installing the product. - Otherwise, it may cause vibration or water leakage.
- Do not install the unit in potentially explosive atmospheres.

Operation

- Avoid excessive cooling and perform ventilation sometimes. - Otherwise, it may do harm to your health.
- Use a soft cloth to clean. Do not use wax, thinner, or a strong detergent. - The appearance of the air conditioner may deteriorate, change color, or develop surface flaws.
- Do not use an appliance for special purposes such as preserving animals vegetables, precision machine, or art articles. - Otherwise, it may damage your properties.
- Do not place obstacles around the flow inlet or outlet. - Otherwise, it may cause the failure of appliance or an accident.

TABLE OF CONTENTS

2 MODEL DESIGNATION

3 TIPS FOR SAVING ENERGY

4 IMPORTANT SAFETY INSTRUCTIONS

9 INSTALLATION PLACES

10 THE INDOOR UNIT INSTALLATION

11 Indoor Unit Drain Piping

12 Wiring Connection

14 REMOTE CONTROLLER INSTALLATION

16 Wired remote controller installation

17 INSTALLATION OF DECORATIVE PANEL (ACCESSORY)

19 TEST RUNNING

20 OPTIONAL OPERATION

20 Installer Setting - Test Run Mode

21 Installer Setting - Setting Address of Central Control

22 Installer Setting - Thermistor

23 Installer Setting - Ceiling Height Selection

24 Installer Setting - Group Setting

25 Installer Setting - Dry Contact Mode Setting

26 Installer Setting - Celsius / Fahrenheit Switching

27 Installer Setting - Optional Function Setting

28 Installer Setting - Remote controller Mode Lock

29 HOW TO SET E.S.P?

INSTALLATION PLACES

- There should not be any heat source or steam near the unit.
- There should not be any obstacles to prevent the air circulation.
- A place where air circulation in the room will be good.
- A place where drainage can be easily obtained.
- A place where noise prevention is taken into consideration.
- Do not install the unit near the door way.
- Ensure the spaces indicated by arrows from the wall, ceiling, or other obstacles.
- The indoor unit must keep the maintenance space.

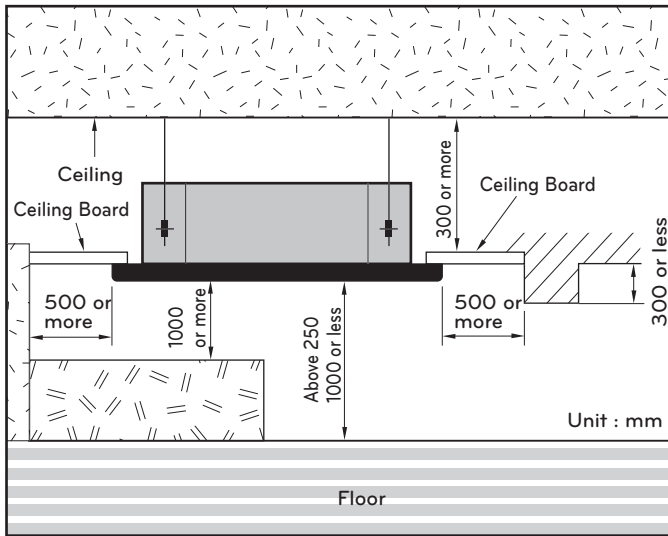

* Please use an annexed sheet or the corrugated cardboard on the bottom of packing as installation sheet.



Annexed sheet

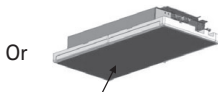

Packing corrugated cardboard on the bottom

* When using the bottom sheet, please use it after separating the installation sheet from packing of the product floor by using a knife etc as a picture below.

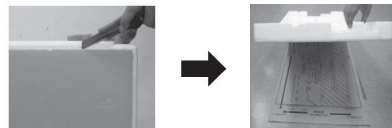

THE INDOOR UNIT INSTALLATION

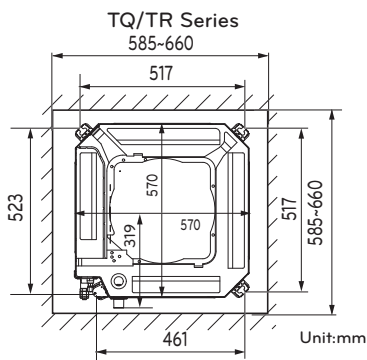
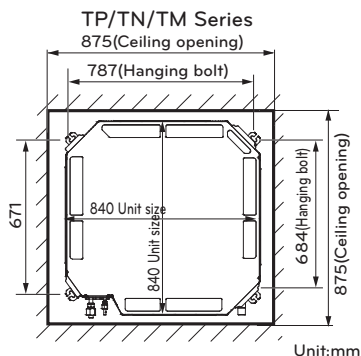
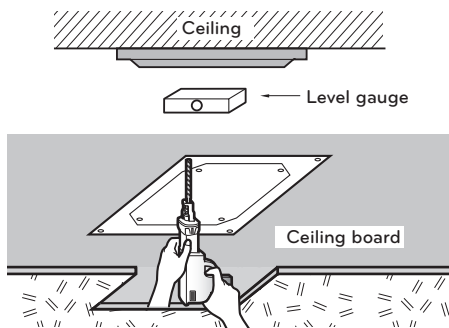

- Select and mark the position for fixing bolts and piping hole.
- Decide the position for fixing bolts slightly tilted to the drain direction after considering the direction of drain hose.
- Drill the hole for anchor bolt on the wall.

! CAUTION

- This air-conditioner uses a drain pump.
- Install the unit horizontally using a level gauge.
- During the installation, care should be taken not to damage electric wires.

! NOTE

Avoid the following installation location.

- 1 Such places as restaurants and kitchen where considerable amount of oil steam and flour is generated. These may cause heat exchange efficiency reduction, or water drops, drain pump mal-function. In these cases, take the following actions;
 - Make sure that ventilation fan is enough to cover all noxious gases from this place.
 - Ensure enough distance from the cooking room to install the air conditioner in such a place where it may not suck oily steam.

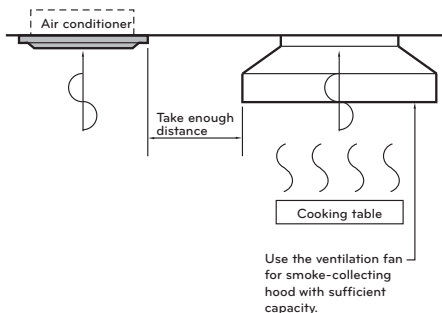

- 2 Avoid installing air conditioner in such places where cooking oil or iron powder is generated.
- 3 Avoid places where inflammable gas is generated.
- 4 Avoid place where noxious gas is generated.
- 5 Avoid places near high frequency generators.

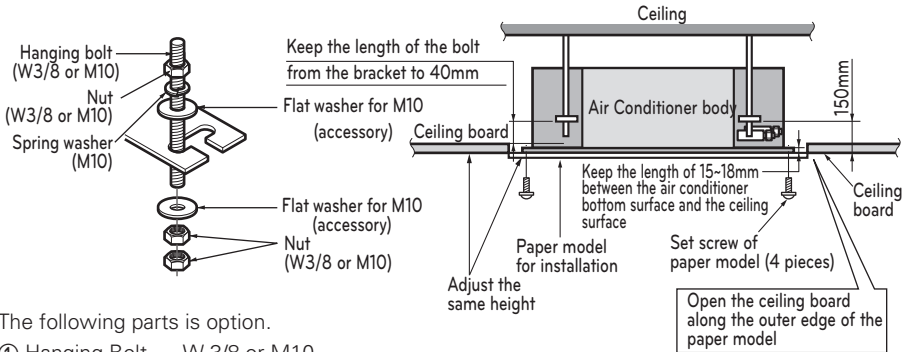

The following parts is option.

- ① Hanging Bolt - W 3/8 or M10
- ② Nut - W 3/8 or M10
- ③ Spring Washer - M10
- ④ Plate Washer - M10

Drill the piping hole on the wall slightly tilted to the outdoor side using a $\varnothing 70$ hole-core drill.

CAUTION

Tighten the nut and bolt to prevent unit falling.

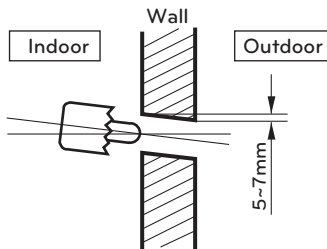

Indoor Unit Drain Piping

- Drain piping must have down-slope (1/50 to 1/100): be sure not to provide up-and-down slope to prevent reversal flow.
- During drain piping connection, be careful not to exert extra force on the drain port on the indoor unit.
- The outside diameter of the drain connection on the indoor unit is 32mm.

Piping material: Polyvinyl chloride pipe VP-25 and pipe fittings

- Be sure to execute heat insulation on the drain piping.
- Install the drain raising pipes at a right angle to the indoor unit and no more than 300mm from the unit.

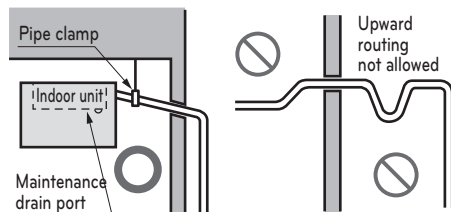

CAUTION

The connecting cable connected to the indoor and outdoor unit should be complied with the following specifications (This equipment shall be provided with a cord set complying with the national regulation).

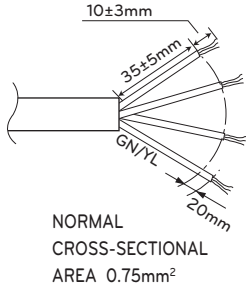

If the supply cord is damaged, it must be replaced by a special cord or assembly available from the manufacturer of its service agent.

CAUTION

The Power cord connected to the unit should be selected according to the following specifications.

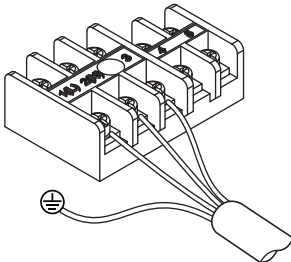

Precautions when laying power wiring

Use round pressure terminals for connections to the power terminal block.

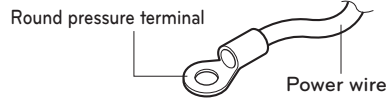

When none are available, follow the instructions below.

- Do not connect wiring of different thicknesses to the power terminal block. (Slack in the power wiring may cause abnormal heat.)
- When connecting wiring which is the same thickness, do as shown in the figure below.

Connect same thickness wiring to both sides.

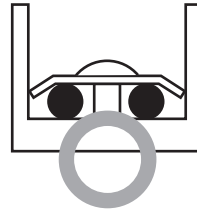

It is forbidden to connect two to one side.

It is forbidden to connect wiring of different thicknesses.

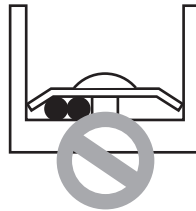

- For wiring, use the designated power wire and connect firmly, then secure to prevent outside pressure being exerted on the terminal block.
- Use an appropriate screwdriver for tightening the terminal screws. A screwdriver with a small head will strip the head and make proper tightening impossible.
- Over-tightening the terminal screws may break them.

REMOTE CONTROLLER INSTALLATION

Please fix tightly using provided screw after placing remote controller setup board on the place where you like to setup.

- Please set it up not to bend because poor setup could take place if setup board bends.
Please set up remote controller board fit to the reclamation box if there is a reclamation box.
- Install the product so as not to make a gap with the wall side and to prevent shaking after the installation.

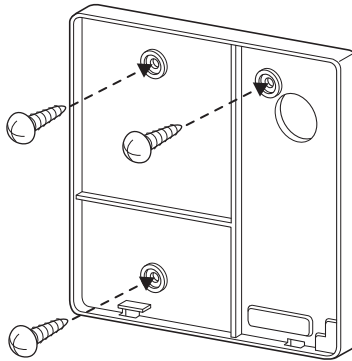

Can set up Wired remote controller cable into three directions.

- Setup direction: the surface of wall reclamation, upper, right
- If setting up remote controller cable into upper and right side, please set up after removing remote controller cable guide groove.
- * Remove guide groove with long nose.

- ① Reclamation to the surface of the wall
- ② Upper part guide groove
- ③ Right part guide groove

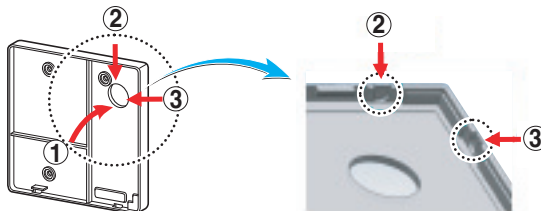

<Wire guide grooves>

Please fix remote controller upper part into the setup board attached to the surface of the wall, as the picture below, and then, connect with setup board by pressing lower part.

- Please connect not to make a gap at the remote controller and setup board's upper and lower, right and left part.
- Before assembly with the installation board, arrange the Cable not to interfere with circuit parts.

<Connecting order>

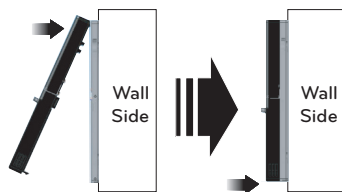

<Separating order>

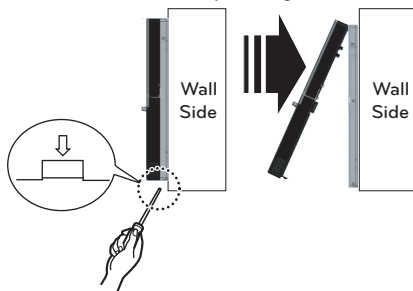

When separating remote controller from setup board, as the picture below, after inserting into the lower separating hole using screw driver and then, spinning clockwise, remote controller is separated.

- There are two separating holes. Please individually separate one at a time.
- Please be careful not to damage the inside components when separating.

Please connect indoor unit and remote controller using connection cable.

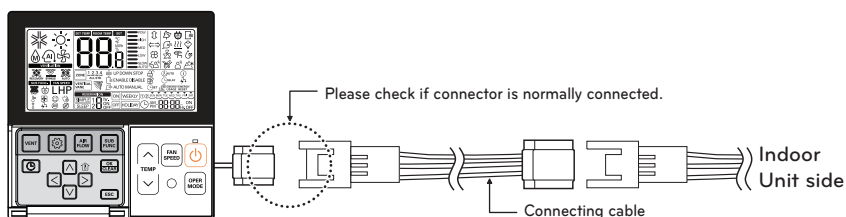

Please use extension cable if the distance between wired remote controller and indoor unit is more than 10m.

⚠ CAUTION

When installing the wired remote controller, do not bury it in the wall. (It can cause damage in the temperature sensor.)

Do not install the cable to be 50m or above. (It can cause communication error.)

- When installing the extension cable, check the connecting direction of the connector of the remote controller side and the product side for correct installation.
- If you install the extension cable in the opposite direction, the connector will not be connected.
- Specification of extension cable: 2547 1007 22# 2 core 3 shield 5 or above.

Wired remote controller installation

Since the room temperature sensor is in the remote controller, the remote controller box should be installed in a place away from direct sunlight, high humidity and direct supply of cold air to maintain proper space temperature. Install the remote controller about 5ft(1.5m) above the floor in an area with good air circulation at an average temperature.

Do not install the remote controller where it can be affected by:

- Drafts, or dead spots behind doors and in corners.
- Hot or cold air from ducts.
- Radiant heat from sun or appliances.
- Concealed pipes and chimneys.
- Uncontrolled areas such as an outside wall behind the remote controller.
- This remote controller is equipped with a seven segment LED display. For proper display of the remote controller LED's, the remote controller should be installed properly as shown in Fig.1. (The standard height is 1.2~1.5 m from floor level.)

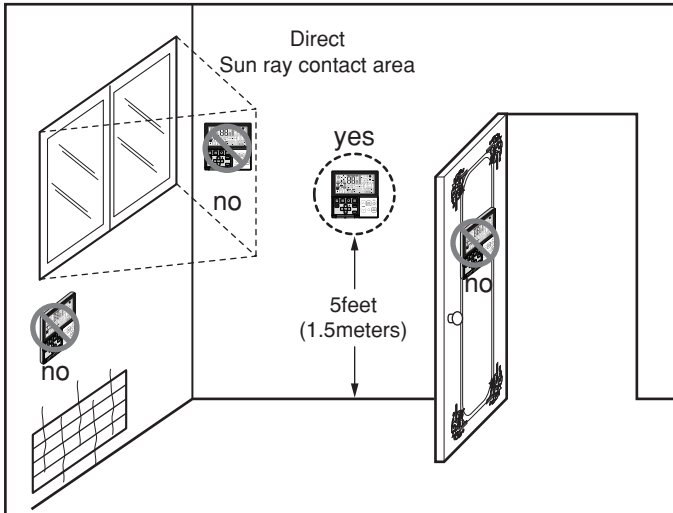

INSTALLATION OF DECORATIVE PANEL(Accessory)

The decorative panel has its installation direction.
Before installing the decorative panel, always remove the paper template.

- 1 Remove the packing and take out air inlet grille from front panel.

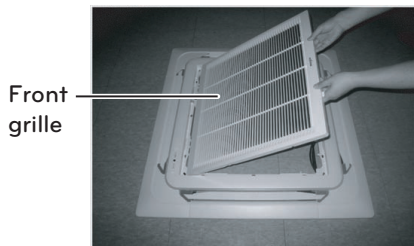

- 2 Remove the Corner covers of the panel.

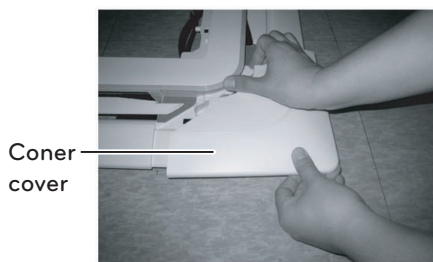

- 3 Fit the panel on the unit by inserting hooks as shown in picture.

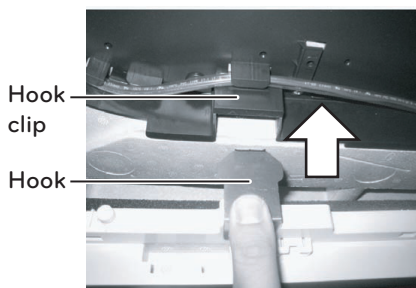

- 4 Insert two screws on diagonal corners of panel. Do not tighten the bolts completely. (The fixing screws are included in the indoor unit box.)
 Check the alignment of panel with the ceiling. Height can be adjusted using hanging bolts as shown in picture. Insert the other two screws and tighten all screws completely.

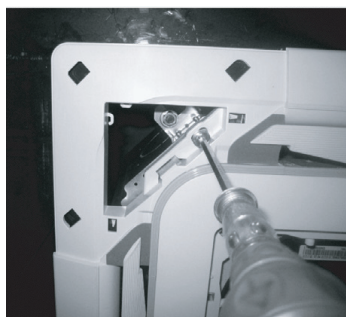

- 5 Fit the corner covers.

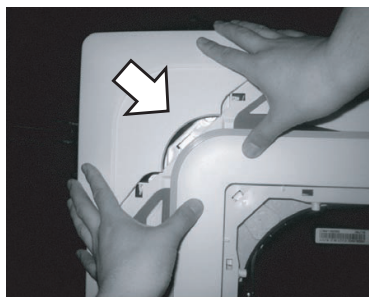

18 INSTALLATION OF DECORATIVE PANEL(ACESSORY)

6 Open two screws of control panel cover.

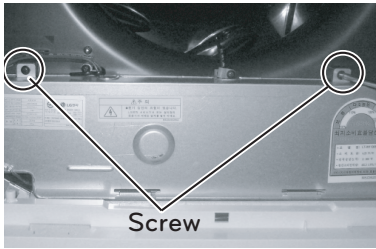

9 Install the air inlet grille and Filter on the panel.

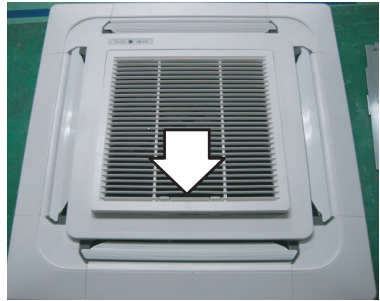

7 Connect one display connector and two vane control connectors of front panel to indoor unit PCB.

The position marking on PCB is as:
 Display connector : CN-DISPLAY
 Vane control connector: CN-VANE 1,2

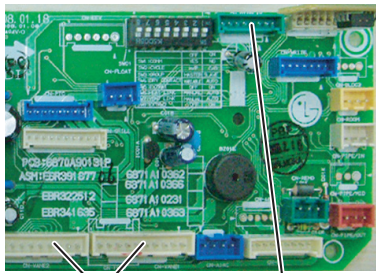

CN-VANE 1,2 CN-DISPLAY

CAUTION

Install certainly the decorative panel.
 Cool air leakage causes sweating. ☞
 Water drops fall.

Good example

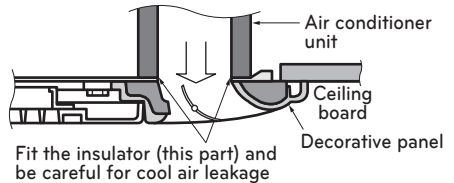

8 Close the cover for control box.

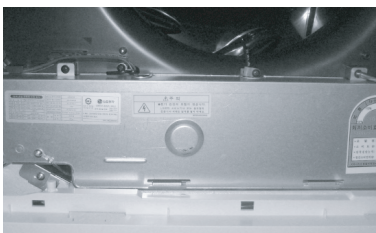

Bad example

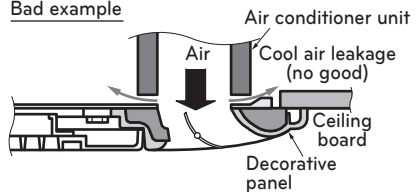

TEST RUNNING

PRECAUTIONS IN TEST RUN

- The initial power supply must provide at least 90% of the rated voltage. Otherwise, the air conditioner should not be operated.



CAUTION

- For test run, carry out the cooling operation firstly even during heating season. If heating operation is carried out firstly, it leads to the trouble of compressor. Then attention must be paid.
- Carry out the test run more than 5 minutes without fail. (Test run will be cancelled 18 minutes later automatically)

- To cancel the test run, press any button.

CHECK THE FOLLOWING ITEMS WHEN INSTALLATION IS COMPLETED

- After completing work, be sure to measure and record trial run properties, and store measured data, etc.
- Measuring items are room temperature, outside temperature, suction temperature, blow out temperature, wind velocity, wind volume, voltage, current, presence of abnormal vibration and noise, operating pressure, piping temperature, compressive pressure.
- As to the structure and appearance, check following items.
 - * Is the circulation of air adequate?
 - * Is the draining smooth?
 - * Is the heat insulation complete (refrigerant and drain piping)?
 - * Is there any leakage of refrigerant?
 - * Is the remote controller switch operated?
 - * Is there any faulty wiring?
 - * Are not terminal screws loosened?

M4.....118N.cm{12kgf.cm}
 M5.....196N.cm{20kgf.cm}
 M6.....245N.cm{25kgf.cm}
 M8.....588N.cm{60kgf.cm}

Connection of power supply

- Connect the power supply cord to the independent power supply. Circuit breaker is required.
- Operate the unit for 15 minutes or more.

Evaluation of the performance

- Measure the temperature of the intake and discharge air.
- Ensure the difference between the intake temperature and the discharge one is more than 8°C (Cooling) or reversely (Heating).

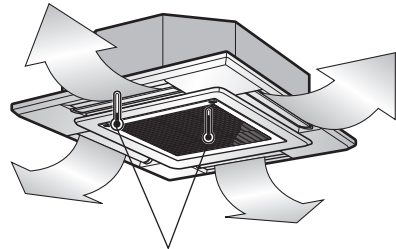

Thermometer

OPTIONAL OPERATION

Installer Setting - Test Run Mode

After installing the product, you must run a Test Run mode.

For details related to this operation, refer to the product manual.

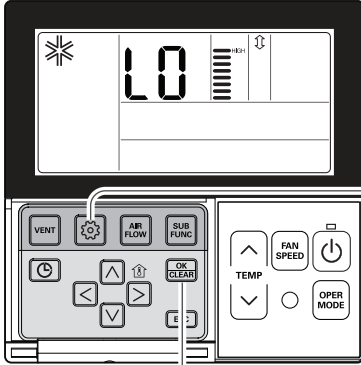

1 If pressing  button long for 3 seconds, it enters into remote controller setter setup mode.

- If pressing once shortly, it enters into user setup mode. Please press more than 3 seconds for sure.
- Please cancel the right and left of wind direction for RAC product.

 Function Code Set

2 Setup figure '01' blinks at the lower part of indication window.

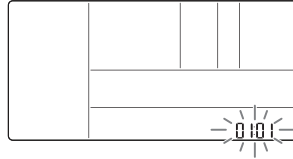

3 Press  button to start.

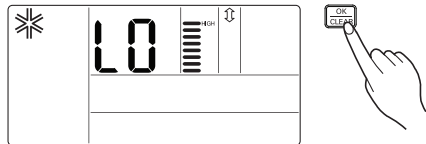

4 During the test run, pressing the below button will exit the test run.

- Select operation, temperature up/down, wind flow control, wind direction, start/stop button.

Installer Setting - Setting Address of Central Control

It's the function to use for connecting central control.

Please refer to central controller manual for the details

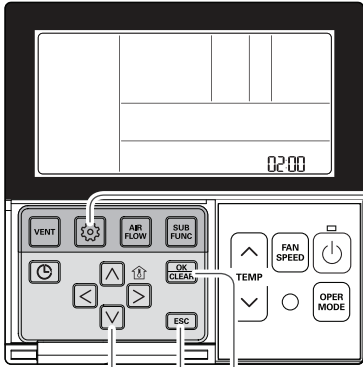

1 If pressing  button long for 3 seconds, it enters into remote controller setter setup mode.
- If pressing once shortly, it enters into user setup mode. Please press more than 3 seconds for sure.



2 If entering into address setup mode by using  button, it indicates as picture below.

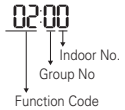
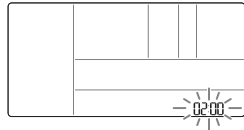

3 Set Group No. by pressing  button.(0~F)

02:F0

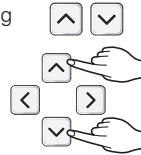

4 Move to Indoor No. setting option by pressing   button.

02:F0

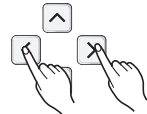

5 Set Indoor No. by pressing  button.

02:F5

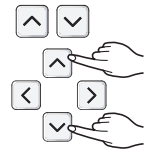

6 Press  button to save.

02:F5



7 Pressing  button will exit settings mode.
* After setup, it automatically gets out of setup mode if there is no button input for 25 seconds.
* When exiting without pressing set button, the manipulated value is not reflected.

Installer Setting - Thermistor

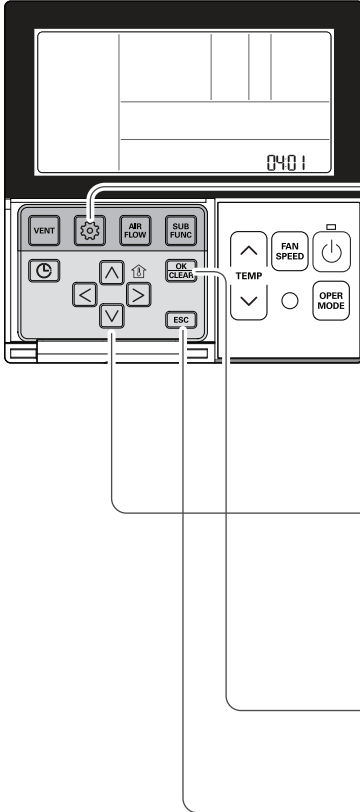

- 1** If pressing button long for 3 seconds, it enters into remote controller setter setup mode.
- If pressing once shortly, it enters into user setup mode. Please press more than 3 seconds for sure.



- 2** If moving to room temperature perception sensor selection menu by pressing button, it indicates as picture below.

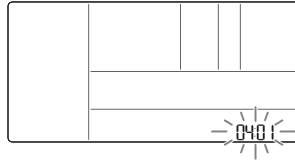

- 3** Set Thermistor value by pressing button. (01: Remote Controller, 02: Indoor, 03: 2TH)

0401
 ↓ ↓
 Function Code Thermistor setting

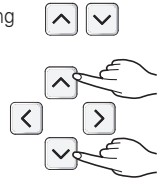

- 4** Press button to save.

0401



- 5** Pressing button will exit settings mode.
 * After setup, it automatically gets out of setup mode if there is no button input for 25 seconds.
 * When exiting without pressing set button, the manipulated value is not reflected.

<Thermistor Table>

Temperature sensor selection		Function	
01	Remote controller	Operation in remote controller temperature sensor	
02	Indoor unit	Operation in indoor unit temperature sensor	
03	2TH	Cooling	Operation of higher temperature by comparing indoor unit's and wired remote controller's temperature. (There are products that operate at a lower temperature.)
		Heating	Operation of lower temperature by comparing indoor unit's and wired remote controller's temperature.

* The function of 2TH has different operation characteristics according to the product.

Installer Setting - Ceiling Height Selection

This function is to adjust FAN Airflow rate according to ceilingheight (only cassette model)

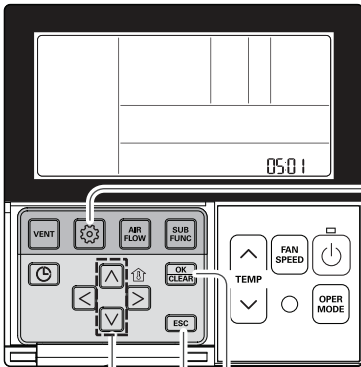

1 If pressing button long for 3 seconds, it enters into remote controller setter setup mode.
- If pressing once shortly, it enters into user setup mode. Please press more than 3 seconds for sure.



2 If moving to ceiling height selection menu by pressing button, it indicates as picture below.

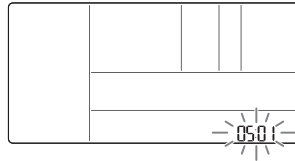

3 Select ceiling height value by pressing button. (01:Low, 02:Standard, 03:High, 04Very high)

0501

Function Code Thermistor setting

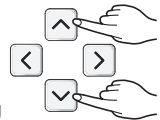

4 Press button to save.

0501



5 Pressing button will exit settings mode.
* After setup, it automatically gets out of setup mode if there is no button input for 25 seconds.
* When exiting without pressing set button, the manipulated value is not reflected.

<Ceiling Height Selection Table>

Ceiling Height Level		Description
01	Low	Decrease the indoor airflow rate 1 step from standard level
02	Standard	Set the indoor airflow rate as standard level
03	High	Increase indoor airflow rate 1 step from standard level
04	Super high	Increase indoor airflow rate 2 steps from standard level

* Ceiling height setting is available only for some products.

* Ceiling height of 'Super high' function may not exist depending on the indoor unit.

* Refer to the product manual for more details.

Installer Setting - Group Setting

It is a function for settings in group control, or 2-remote controller control.

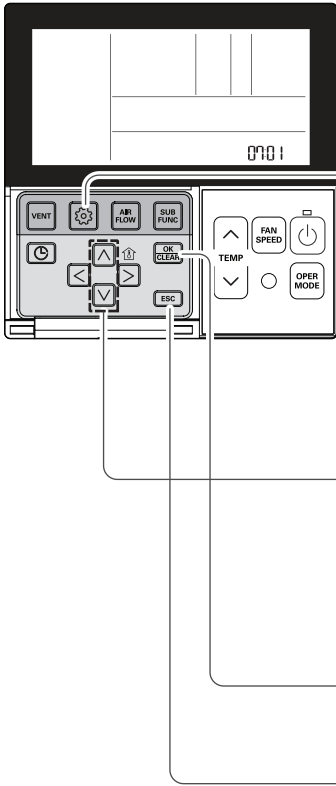

1 If pressing button long for 3 seconds, it enters into remote controller setter setup mode.
- If pressing once shortly, it enters into user setup mode. Please press more than 3 seconds for sure.



2 If pressing button repeatedly, it moves to master/slave selection menu as picture below.

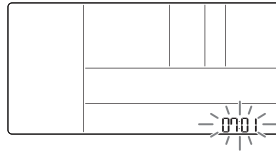

3 Select Master/ Slave by pressing button.
(00: Slave, 01: Master)

07:01
Function Code Master/Slave value

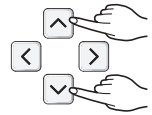

4 Press button to save.

07:01



5 Pressing button will exit settings mode.
* After setup, it automatically gets out of setup mode if there is no button input for 25 seconds.
* When exiting without pressing set button, the manipulated value is not reflected.

Remote controller	Function
Master	Indoor unit operates based on master remote controller at group control. (Master is set when delivering from the warehouse.)
Slave	Setup all remote controllers except one master remote controller to slave at group control

* Refer to the 'group control' part for details

- When controlling in groups, basic operation settings, airflow strength weak/medium/strong, lock setting of the remote controller, time settings, and other functions may be restricted.

Installer Setting - Dry Contact Mode Setting

Dry contact function is the function that is possible to use only when dry contact equipment is separately purchased/setup.

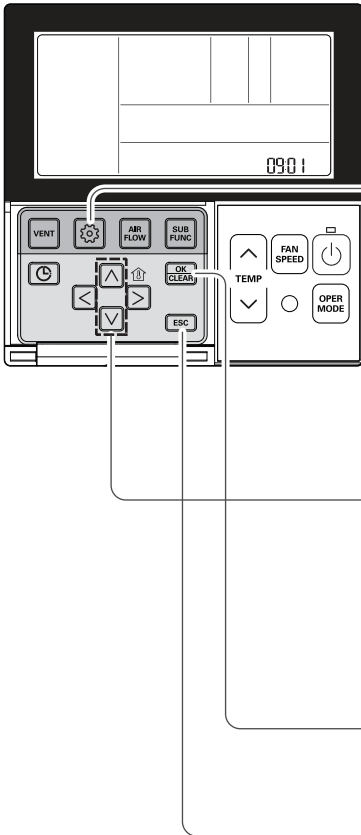

1 If pressing button long for 3 seconds, it enters into remote controller setter setup mode.
- If pressing once shortly, it enters into user setup mode. Please press more than 3 seconds for sure.



2 If pressing button repeatedly, it moves to remote controller dry contact mode setup menu as picture below.



3 Select Dry contact setting by pressing button.
(00 : Automatic, 01 : manual)



4 Press button to save.

09:01



5 Pressing button will exit settings mode.
* After setup, it automatically gets out of setup mode if there is no button input for 25 seconds.
* When exiting without pressing set button, the manipulated value is not reflected.

What is Dry Contact?



Like hotel card key and body perception sensor, it is the signal of the point of contact when using air-conditioner by interlocking.

- Please refer to dry contact manual for more details.

Installer Setting - Celsius / Fahrenheit Switching

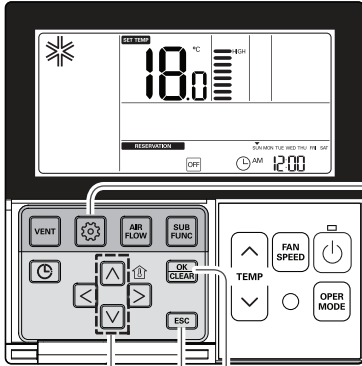
This function is used for switching the display between Celsius and Fahrenheit.
(Optimized only for U.S.A)





- 1 If pressing  button long for 3 seconds, it enters into remote controller setter setup mode.
- If pressing once shortly, it enters into user setup mode.
Please press more than 3 seconds for sure. 

- 2 Repeat pressing  button to select Function code 12.

12:00
↓ ↓
Function Code conversion mode value

Ex) Fahrengit Setting

- 3 Select Temperature unit mode by pressing   button.
(00: Celsius, 01: Fahrenheit)

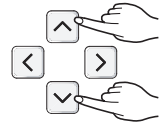

12:01



- 4 Press  button to save or release.

12:01





- 5 Press  button to exit or system will automatically exit after 25 seconds without any input. 

* Whenever press   button in Fahrenheit mode, the temperature will increase/drop 2 degrees.

Installer Setting - Optional Function Setting

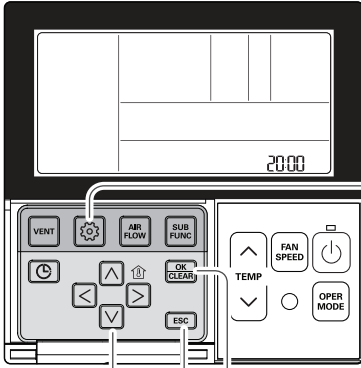
Setting feature for indoor unit when air cleaning / heater / humidifier / Up/down grill / Ventilation KIT / Auxiliary Heater is newly installed, or installed unit is removed.





1 If pressing  button long for 3 seconds, it enters into remote controller setter setup mode.
- If pressing once shortly, it enters into user setup mode. Please press more than 3 seconds for sure.

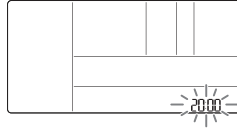

2 If pressing  button repeatedly, it moves to the selected option function code as picture below.



Function	Code
Plasma purification	20
Electric heater	21
Dehumidifier	22
Elevation grill	23
Ventilation kit	24
Auxiliary heater	25

3 Select existing condition of each mode by pressing   button.
(00: not installed,
01 : installed)

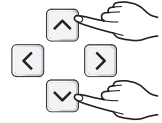

2000

Function Code Existing condition

4 Press  button to save.



5 Pressing  button will exit settings mode.
* After setup, it automatically gets out of setup mode if there is no button input for 25 seconds.
* When exiting without pressing set button, the manipulated value is not reflected.

Installer Setting - Remote controller Mode Lock

This function is used to limit 'operation-mode' selection setting.

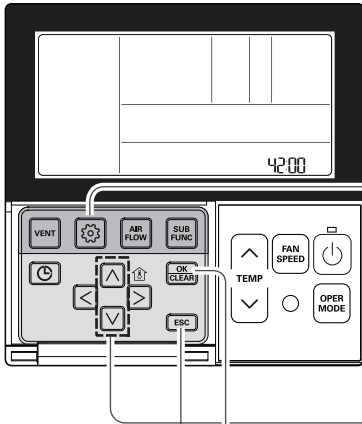



- 1** Press and hold  button for more than 3 seconds to enter the installer settings mode.



- 2** Move to the installer code number 42 in the menu using  button.



- 3** Select the remote control master/slave using   button.

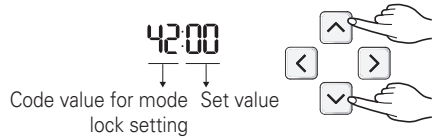

code	Description
42:00	Doesn't limit operation mode setting.
42:01	User can setting to cooling mode only.
42:02	User can setting to heating mode only.

- 4** Press  button to save the setting.

- 5** Press  button to exit.

* It can limit only wired remote controller button. other controllers can change operation mode. (for example wireless remote controller and central controller)

HOW TO SET E.S.P.?

This is the function that decides the strength of the wind for each wind level and because this function is to make the installation easier.

- If you set ESP incorrectly, the air conditioner may malfunction.
- This setting must be carried out by a certificated-technician.

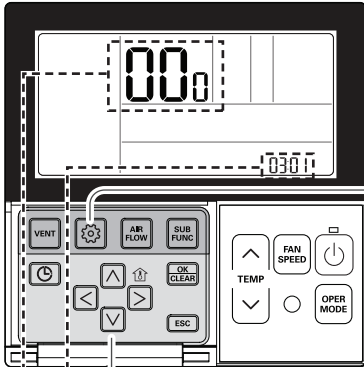

Function code,
ESP code
ESP value

- 1 If pressing button long for 3 seconds, it enters into remote controller setter setup mode.
- If pressing once shortly, it enters into user setup mode. Please press more than 3 seconds for sure.

- 2 If entering into ESP setup mode by using button, it indicates as the picture below.

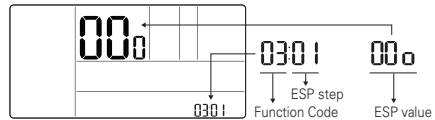

- 3 Select ESP fan step by pressing button. (01: very low, 02: low, 03: medium, 04: high, 05: power)

0301

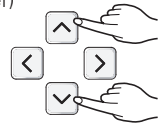

- 4 Move to ESP value setting by pressing button.
(It is 000 when delivering from the warehouse.)

0301 000

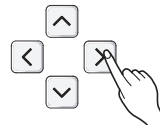

- 5 Press button to setup ESP value.

(It is possible to setup ESP value from 1 to 255, and 1 is the smallest and 255 is the biggest.)

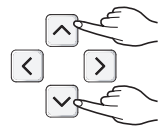

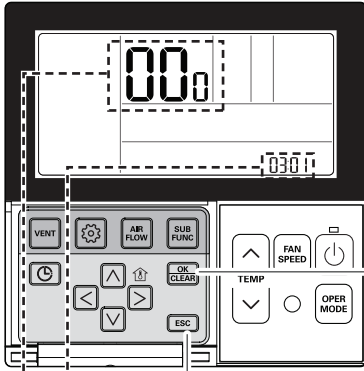

- When setting ESP value on the product without very weak wind or power wind function, it may not work.



Function code,
ESP code

ESP value

6 Select ESP fan step again by using   button and setup ESP value, as No. 4 and 5, that corresponds each wind flow

7 Press  button to save.



8 Press  button to exit.
 * After setup, it automatically gets out of setup mode if there is no button input for 25 seconds.
 * When exiting without pressing set button, the manipulated value is not reflected.

- Please be careful not to change the ESP value for each fan step.
- It does not work to setup ESP value for very low/power step for some products.
- ESP value is available for specific range belongs to the product.



Manufacturer :

LG Electronics Inc.

84, Wanam-ro, Seongsan-gu, Changwon-si, Gyeongsangnam-do, KOREA

UK Importer : LG Electronics U.K. Ltd

Velocity 2, Brooklands Drive, Weybridge, KT13 0SL

Eco design requirement

- The information for Eco design is available on the following free access website.
<https://www.lg.com/global/support/cedoc/cedoc>