

Please read this manual carefully before operating your set and retain it for future reference.

Veuillez lire ce guide de configuration rapide attentivement avant d'utiliser votre produit et conservez-le pour pouvoir vous y reporter ultérieurement.

Lea atentamente este manual antes de poner en funcionamiento el equipo y consérvelo para futuras consultas.



* M F L 0 5 7 9 5 5 3 2 *

(2506-REV00)

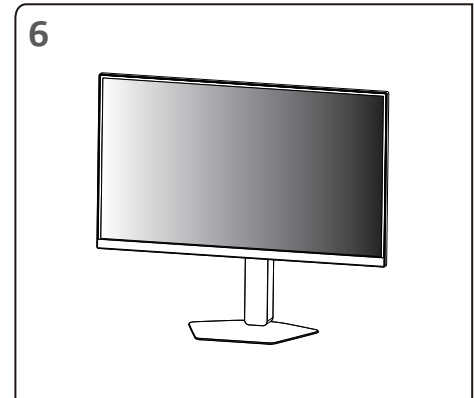
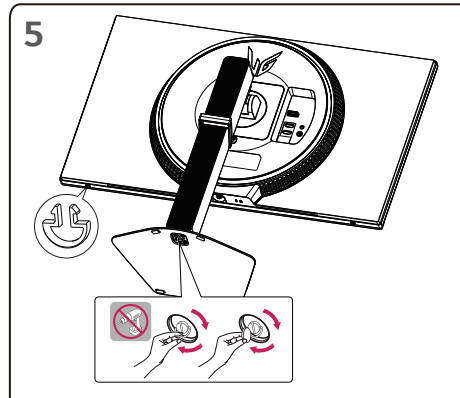
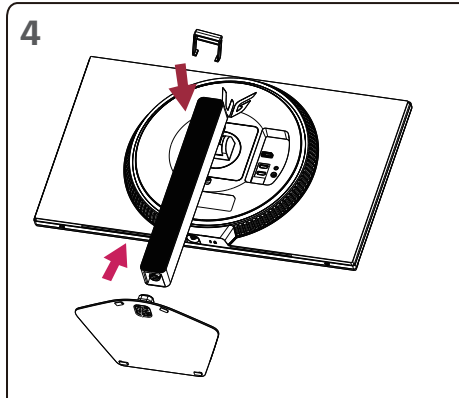
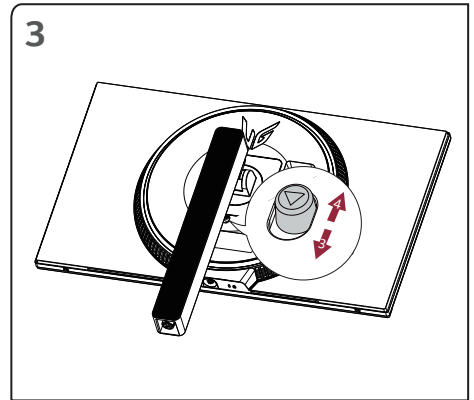
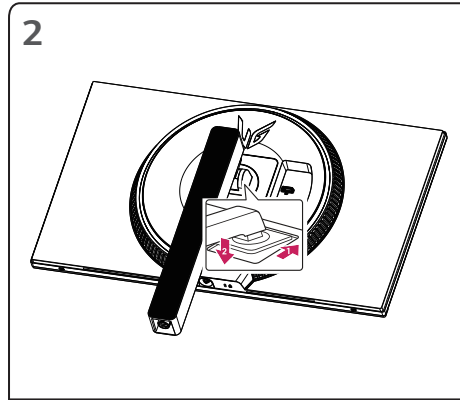
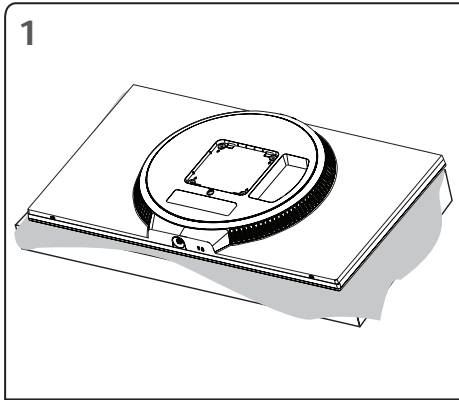

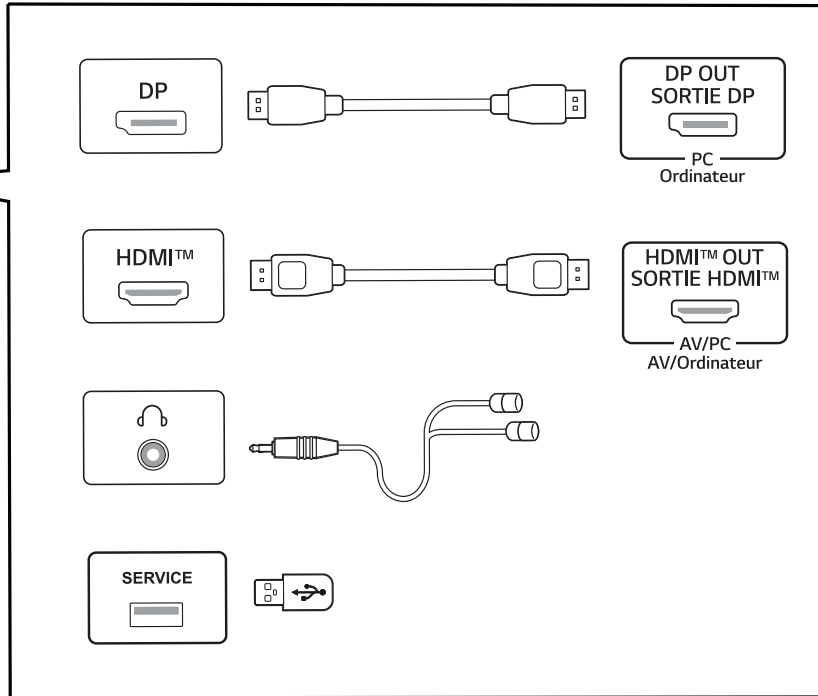
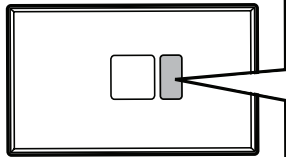



a

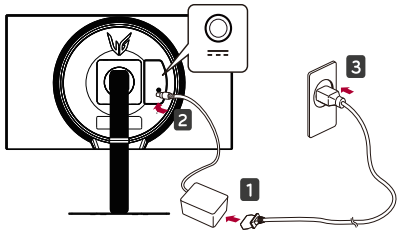

b

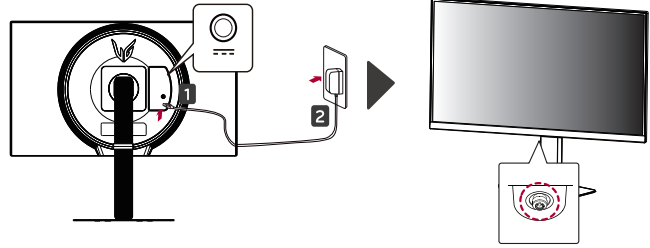



English	Dimensions (Width x Height x Depth)		Weight		Recommend Resolution	Vertical Frequency
	With Stand	Without Stand	With Stand	Without Stand		
	614.2 x 540.7 x 220 (mm) 24.1 x 21.2 x 8.6 (inches)	614.2 x 364.8 x 51.7 (mm) 24.1 x 14.3 x 2.0 (inches)	6.5 kg 14.3(lbs)	4.0 kg 8.8(lbs)	1920 x 1080	240 Hz
Français	Dimensions (largeur x hauteur x profondeur)		Poids		Résolution recommandée	Fréquence verticale
	Avec socle	Sans socle	Avec socle	Sans socle		
	614,2 x 540,7 x 220 (mm) 24,1 x 21,2 x 8,6 (po)	614,2 x 364,8 x 51,7 (mm) 24,1 x 14,3 x 2,0 (po)	6,5 kg 14,3(lb)	4,0 kg 8,8(lb)	1 920 x 1 080	240 Hz
Español	Dimensiones (anchura x altura x profundidad)		Peso		Resolución recomendada	Frecuencia vertical
	Soporte incluido	Soporte no incluido	Soporte incluido	Soporte no incluido		
	614,2 x 540,7 x 220 (mm)	614,2 x 364,8 x 51,7 (mm)	6,5 kg	4,0 kg	1 920 x 1 080 píxeles	240 Hz
	Alimentación	19 V \equiv 2,0 A				
Especificaciones de Adaptador de ca/cc	Salida	19 V \equiv 2,1 A				
	Entrada	100-240 V~ 50/60 Hz 1,2 A				

**English****ARBITRATION NOTICE (USA) / États-Unis seulement**

By using this product, you agree that all disputes between you and LG arising out of or relating in any way to this product (including but not limited to warranty disputes) shall be resolved through binding arbitration on an individual basis, unless the laws of your state or territory do not permit that, or, in other jurisdictions, if you choose to opt out.

Additional information regarding the terms of the arbitration agreement (including details on the procedure for resolving disputes) is available at www.lg.com/us/arbitration (USA) and/or your owner's manual or warranty.

Español**AVISO DE ARBITRAJE (EE. UU.)**

Al utilizar este producto, usted acepta que todas las disputas entre usted y LG que surjan de este producto o se relacionen de alguna manera con él (incluidas, entre otras, las disputas de garantía) se resolverán mediante arbitraje vinculante de forma individual, a menos que las leyes de su estado o territorio no lo permitan, o en otras jurisdicciones, si decide optar por no participar.

Los sitios web www.lg.com/us/arbitration (EE. UU.) y/o el manual del propietario o la garantía contienen información adicional sobre los términos del acuerdo de arbitraje (incluidos detalles sobre el procedimiento para resolver disputas).

