



OWNER'S MANUAL

# MICROWAVE OVEN

Please read this owner's manual thoroughly before operating.

MS253 \*\*\*\* MS233 \*\*\*\* MS423 \*\*\*\*\* MS363 \*\*\*\*\*  
(optional, please check model specification)



MFL69675705\_02

[www.lg.com](http://www.lg.com)

Copyright © 2018-2019 LG Electronics Inc. All Rights Reserved

## How the Microwave Function Works

Microwaves are a form of energy similar to radio, television waves, and ordinary daylight. Normally, microwaves spread outwards as they travel through the atmosphere and disappear without effect.

This oven, however, has a magnetron that is designed to make use of the energy in microwaves. Electricity, supplied to the magnetron tube, is used to create microwave energy.

These microwaves enter the cooking area through openings inside the oven. A tray is located inside the oven. Microwaves cannot pass through metal walls of the oven, but they can penetrate such materials as glass, porcelain and paper, the materials out of which microwave-safe cooking dishes are constructed.

Microwaves do not heat cookware, though cooking vessels will eventually get hot from the heat generated by the food.

## A very safe appliance

**Your Microwave oven, is one of the safest of all home appliances. When the door is opened, the oven automatically stops producing microwaves. Microwave energy is converted completely to heat when it enters food, leaving no "left over" energy to harm you when you eat your food.**

# CONTENTS

---

## 3 IMPORTANT SAFETY INSTRUCTIONS

---

## 8 BEFORE USE

---

- 8 Unpacking & Installing
- 10 Control Panel
- 10 Display Picto
- 11 Setting Clock
- 11 Quick Start
- 11 More/Less
- 11 Energy Saving

---

## 12 HOW TO USE

---

- 12 Timed Cooking
- 12 Microwave Power Levels
- 13 Child Lock
- 13 Reheat
- 13 Reheat Menu Instructions
- 14 Popular Menu
- 14 Popular Menu Instructions
- 18 Soften
- 18 Soften Menu Instructions
- 19 Melt
- 19 Melt Menu Instructions
- 20 Proof
- 20 Proof Menu Instructions
- 21 Keep Warm
- 22 Inverter Defrost
- 22 Inverter Defrost Menu Instructions

---

## 23 MICROWAVE-SAFE UTENSILS

---

## 24 FOOD CHARACTERISTICS & MICROWAVE COOKING

---

---

## 26 TO CLEAN YOUR OVEN

---

## 26 USING THE SMART DIAGNOSIS™ FUNCTION

---

---

## 27 QUESTIONS & ANSWERS

---

---

## 28 TECHNICAL SPECIFICATIONS

---

# IMPORTANT SAFETY INSTRUCTIONS

## READ CAREFULLY AND KEEP FOR FUTURE REFERENCE

Read and follow all instructions before using your oven to prevent the risk of fire, electric shock, personal injury, or damage when using the oven. This guide does not cover all possible conditions that may occur.

Always contact your service agent or manufacturer about problems that you do not understand.

### WARNING

This is the safety alert symbol. This symbol alerts you to potential hazards that can kill or hurt you and others. All safety messages will follow the safety alert symbol and either the word "WARNING" or "CAUTION". These word means:

#### WARNING

This symbol will alert you to hazards or unsafe practices which could cause serious bodily harm or death.

#### CAUTION

This symbol will alert you to hazards or unsafe practices which could cause bodily injury or property damage.

### WARNING

- 1 **Do not attempt to tamper with, or make any adjustments or repairs to the door, door seals, control panel, safety interlock switches or any other part of the oven which would involve the removal of any cover protecting against exposure to microwave energy. Do not operate the oven if the door seals and adjacent parts of the microwave oven are faulty. Repairs should only be undertaken by a qualified service technician.**
  - Unlike other appliances, the microwave oven is a high-voltage and a high electrical-current piece of equipment. Improper use or repair could result in harmful exposure to excessive microwave energy or in electric shock.
- 2 **Do not use the oven for the purpose of dehumidification. (ex. Operating the microwave oven with wet newspapers, clothes, toys, electric devices, pet or child etc.)**
  - It can be the cause of serious damage to safety such as a fire, a burn or a sudden death due to an electric shock.
- 3 **This appliance is not intended for use by persons (including children) with reduced physical, sensory or mental capabilities, or lack of experience and knowledge, unless they have been given supervision or instruction concerning use of the appliance by a person responsible for their safety. (Young) Children should be supervised to ensure that they do not play with the appliance.**
  - Improper use may cause damage such as a fire, electric shock or burn.
- 4 **Accessible parts may become hot during use. Young children should be kept away.**
  - They may get a burn.
- 5 **Liquids and other foods must not be heated in sealed containers since they are liable to explode. Remove the plastic wrapping from food before cooking or defrosting. Note though that in some cases food should be covered with plastic film, for heating or cooking.**
  - They could burst.
- 6 **Be certain to use proper accessories on each operation mode .**
  - Improper use could result in damage to your oven and accessories, or could make spark and a fire.
- 7 **The children should not allow to play with accessories or hang down from the door handle.**
  - They may get hurt.

- 8 **I**t is hazardous for anyone other than a competent person to carry out any service or repair operation that involves the removal of a cover which gives protection against exposure to microwave energy.
- 9 **W**hen the appliance is operated in the combination mode, children should only use the oven under adult supervision due to the temperatures generated.
- 10 **D**o not operate your oven if it is damaged. It is particularly important that the oven door closes properly and that there is no damage to the: (1) door(bent), (2) hinges and latches (broken or loosened), (3) door seals and sealing surfaces.
  - It could result in harmful exposure to excessive microwave energy.
- 11 **I**f the door or door seals are damaged, the oven must not be operated until it has been repaired by a competent person.
- 12 **T**he appliance is supplied from a cord extension set or an electrical portable outlet device, the cord extension set on electrical portable outlet device must be positioned so that it is not subject to splashing or ingress of moisture.
- 13 **O**nly allow children to use the oven without supervision when adequate instructions have been given so that the child is able to use the oven in a safe way and understands the hazards of improper use.
- 14 **T**he appliance and its accessible parts become hot during use. Care should be taken to avoid touching heating elements. Children less than 8 years of age shall be kept away unless continuously supervised.
- 15 **D**uring use the appliance becomes hot. Care should be taken to avoid touching heating elements inside the oven.
- 16 **D**o not use harsh abrasive cleaners or sharp metal scrapers to clean the oven door glass since they can scratch the surface, which may result in shattering of the glass

## CAUTION

- 1 **Y**ou cannot operate your oven with the door open due to the safety interlocks built into the door mechanism. **I**t is important not to tamper with the safety interlocks.
  - It could result in harmful exposure to excessive microwave energy. (Safety interlocks automatically switch off any cooking activity when the door is opened.)
- 2 **D**o not place any object (such as kitchen towels, napkins, etc.) between the oven front face and the door or allow food or cleaner residue to accumulate on sealing surfaces.
  - It could result in harmful exposure to excessive microwave energy.
- 3 **P**lease ensure cooking times are correctly set, small amounts of food require shorter cooking or heating time.
  - Over cooking may result in the food catching on fire and subsequent damage to your oven.
- 4 **W**hen heating liquids, e.g. soups, sauces and beverages in your microwave oven,
  - \* **A**void using straight sided containers with narrow necks.
  - \* **D**o not overheat.
  - \* **S**tir the liquid before placing the container in the oven and again halfway through the heating time.
  - \* **A**fter heating, let it stand in the oven for a short time; stir or shake it again carefully and check the temperature of it before consuming to avoid burns (especially, contents of feeding bottles and baby food jars).
  - Be careful when handling the container. Microwave heating of beverages can result in delayed eruptive boiling, therefore care must be taken when handling the container.
- 5 **A**n exhaust outlet is located on the top, bottom or side of the oven. **D**on't block the outlet.
  - It could result in damage to your oven and poor cooking results.

- 6 **Do not operate the oven when empty.** It is best to leave a glass of water in the oven when not in use.  
**The water will safely absorb all microwave energy, if the oven is accidentally started.**
  - Improper use could result in damage to your oven.
- 7 **Do not cook food wrapped in paper towels, unless your cook book contains instructions for the food you are cooking. And do not use newspaper in place of paper towels for cooking.**
  - Improper use can cause an explosion or a fire.
- 8 **Do not use wooden containers and ceramic containers that have metallic (e.g. gold or silver) inlays. Always remove metal twist ties. Only use utensils that are suitable for use in microwave ovens.**
- 9 **Do not use recycled paper products.**
  - They may contain impurities which may cause sparks and/or fires when used in cooking.
- 10 **Do not rinse the tray and rack by placing it in water just after cooking. This may cause breakage or damage.**
  - Improper use could result in damage to your oven.
- 11 **Be certain to place the oven so the front of the door is 8 cm or more behind the edge of the surface on which it is placed, to avoid accidental tipping of the appliance.**
  - Improper use could result in bodily injury and oven damage.
- 12 **Before cooking, pierce the skin of potatoes, apples or any such fruit or vegetables.**
  - They could burst.
- 13 **Do not cook eggs in their shell. Eggs in their shell and whole hard-boiled eggs should not be heated in microwave ovens since they may explode, even after microwave heating has ended.**
  - Pressure will build up inside the egg which will burst.
- 14 **Do not attempt deep fat frying in your oven.**
  - This could result in a sudden boil over of the hot liquid.
- 15 **If smoke is observed (or emitted), switch off or unplug the appliance and keep the door closed in order to stifle any flame.**
  - It can cause serious damage such as a fire or electric shock.
- 16 **When heating food in plastic or paper containers, keep an eye on the oven due to the possibility of ignition .**
  - Your food may be poured due to the possibility of container deterioration, which also can cause a fire.
- 17 **The temperature of accessible surfaces may be high when the appliance is operating. Do not touch the oven door, outer cabinet, rear cabinet, oven cavity, accessories and dishes during grill mode, convection mode and auto cook operations, before clearing make sure they are not hot.**
  - As they will become hot, there is the danger of a burn unless wearing thick culinary gloves.
- 18 **The oven should be cleaned regularly and any food deposits should be removed.**
  - Failure to maintain the oven in a clean condition could lead to deterioration of the surface that could adversely affect the life of the appliance and possibly result in a hazardous situation.

**19 Only use the temperature probe recommended for this oven.**

- You can not ascertain that the temperature is accurate with an unsuitable temperature probe.
- This model doesn't provide a temperature probe.

**20 This appliance is intended to be used in household and similar applications such as:**

- Staff kitchen areas in shops, offices and other working environments;
- Farm houses;
- By clients in hotels, motels and other residential environments;
- Bed and breakfast type environments.

**21 This appliance can be used by children aged from 8 years and above and persons with reduced physical, sensory or mental capabilities or lack of experience and knowledge if they have been given supervision or instruction concerning use of the appliance in a safe way and understand the hazards involved. Children shall not play with the appliance. Cleaning and user maintenance shall not be made by children unless they are aged from 8 years and above and supervised.****22 The microwave oven is intended for heating food and beverages. Drying of food or clothing and heating of warming pads, slippers, sponges, damp cloth and similar may lead to risk of injury, ignition or fire.****23 The appliance is not intended to be operated by means of an external timer or separate remote-control system.****24 Follow exact directions given by each manufacturer for their popcorn product. Do not leave the oven unattended while the corn is being popped. If corn fails to pop after the suggested times, discontinue cooking. Never use a brown paper bag for popping corn. Never attempt to pop leftover kernels.**

- Overcooking could result in the corn catching a fire.

**25 This appliance must be earthed.**

The wires in the mains lead are coloured in accordance with the following codes

**BLUE** ~ Neutral

**BROWN** ~ Live

**GREEN & YELLOW** ~ Earth

As the colours of the wires in the mains lead of this appliance may not correspond with the coloured markings identifying the terminals in your plug proceed as follows:

The wire which is coloured **BLUE** must be connected to the terminal which is marked with the letter **N** or coloured **BLACK**.

The wire which is coloured **BROWN** must be connected to the terminal which is marked with the letter **L** or coloured **RED**.

The wire which is coloured **GREEN & YELLOW** or **GREEN** must be connected to the terminal which is marked with the letter **G** or .

If the supply cord is damaged, it must be replaced by the manufacturer, its service agent or similarly qualified persons in order to avoid a hazard.

- Improper use may cause serious electric damage.

**26 Only use utensils that are suitable for use in microwave ovens.**

- 27 **T**his oven should not be used for commercial catering purposes.
- Improper use could result in damage to your oven.
- 28 **T**he microwave oven must not be placed in a cabinet.
- The microwave oven is intended to be used freestanding.
- 29 **T**he connection may be achieved by having the plug accessible or by incorporating a switch in the fixed wiring in accordance with the wiring rules.
- Using improper plug or switch can cause an electric shock or a fire.
- 30 **T**he door or the outer surface may get hot when the appliance is operating.
- 31 **K**eeP the appliance and its cord out of reach of children less than 8 years.
- 32 **T**he contents of feeding bottles and baby food jars shall be stirred or shaken and the temperature checked before consumption, in order to avoid burns.
- 33 **K**eeP the inside and outside of the oven clean. **T**he details of how to clean your oven pls reference above content " **T**o **C**lean **Y**our **O**ven ".
- 34 **A**ccording to the installation requirements set, otherwise the impact of heat, prone to danger.
- 35 **S**tream cleaner is not to be used.
- 36  **C**autiOn, hot surface
- W**hen the symbol is used, It means that the surfaces are liable to get hot during use.
- 37 **D**o not place an object(a book, a box, etc.) on the product. **T**he product may overheat or catch fire or the object may fall, causing injury to persons.
- 38 **M**etallic containers for food and beverages are not allowed during microwave cooking.
- T**his requirement is not applicable if the manufacturer specifies size and shape of metallic containers suitable for microwave cooking.

# BEFORE USE

## UNPACKING & INSTALLING

By following the basic steps on these two pages you will be able to quickly check that your oven is operating correctly. Please pay particular attention to the guidelines on where to install your oven. When unpacking your oven make sure you remove all accessories and packing materials. Check to make sure that your oven has not been damaged during shipping.

1 Unpack your oven and place it on a flat level surface.

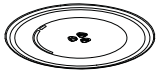

**GLASS TRAY**



**ROTATING RING**



**TURNTABLE SHAFT**

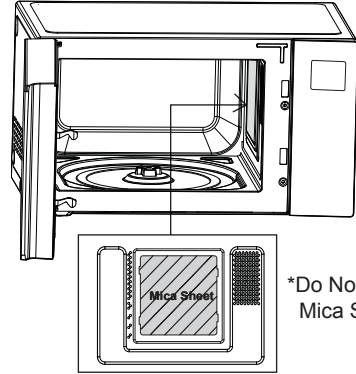

### ! NOTE

- Do not remove the cavity Mica Sheet (silver plate) inside of oven. The Mica Sheet is there to protect the microwave components from food spatters.

2 Place the oven on the level location of your choice with more than 85cm height but make sure there is at least 20 cm of space on the top and 20 cm at the rear & left & right for proper ventilation. The front of the oven should be at least 8 cm from the edge of the surface to prevent tipping.

An exhaust outlet is located on bottom or side of the oven. Blocking the outlet can damage the oven.

If you use the microwave oven in an enclosed space or cupboard, The air flow for cooling the product could be worse. It may result in lower performance and reduced service life. If possible, please use the microwave oven in the counter top condition.

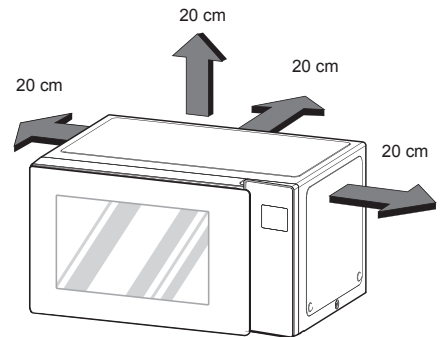

### ! NOTE

- THIS OVEN SHOULD NOT BE USED FOR COMMERCIAL CATERING PURPOSES.

3 Plug your oven into a standard household socket. Make sure your oven is the only appliance connected to the socket. **If your oven does not operate properly, unplug it from the electrical socket and then plug it back in.**

4 Open your oven door by pulling the door handle. Place the rotating ring inside the oven and place the glass tray on top.

5 Fill a **microwave safe container** with 300 ml (1/2 pint) of water. Place on the glass tray and close the oven door. If you have any doubts about what type of container to use please refer to Microwave-safe utensils.

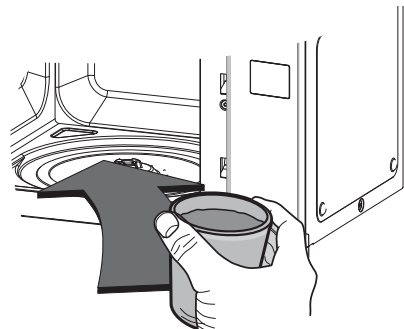

- 6 Press the **STOP / Cancel** button, and press the **START** button one time to set 30 seconds of cooking time.



- 7 The **DISPLAY** will count down from 30 seconds. When it reaches 0 it will sound BEEPS. Open the oven door and test the temperature of the water. If your oven is operating the water should be warm. **Be careful when removing the container it may be hot.**



### YOUR OVEN IS NOW INSTALLED

- 8 The contents of feeding bottles and baby food jars shall be stirred or shaken and the temperature checked before consumption in order to avoid burns.

- 9 Button recognition may be hampered in the following circumstances:
- Only the outside area of the button is pressed.
  - The button is pushed using a nail or the tip of the finger.

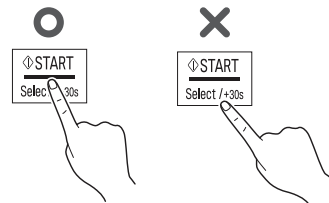

### ! NOTE

Do not use rubber gloves or disposable gloves.  
When wiping the touch control panel with a wet towel, remove moisture from the touch control panel when finished.

- 10 The setting of the cooking time should be shorter than common microwave ovens (700 W, 800 W) due to the relatively high output power of the product. Excessive heating with the product may cause moisture on the door.

## CONTROL PANEL

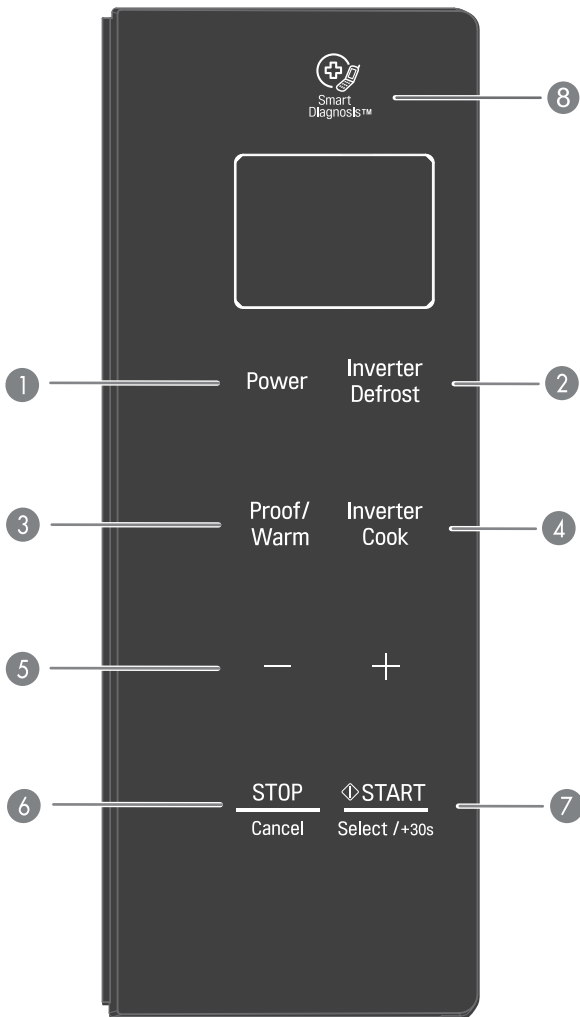

Part	
<b>1 POWER</b>	See page 12 "Timed Cooking"
<b>2 INVERTER DEFROST</b>	See page 22 "Inverter Defrost"
<b>3 PROOF / WARM</b>	See page 20 "Proof" See page 21 "Keep Warm"
<b>4 INVERTER COOK</b>	Inverter Cook allows you to cook most of your favorite food by selecting the food type and the weight of the food. See page 13 "Reheat" See page 14 "Popular Menu" See page 18 "Soften" See page 19 "Melt"
<b>5 MORE / LESS</b>	<ul style="list-style-type: none"> <li>• Choose the cooking menu.</li> <li>• Set cooking time and weight.</li> <li>• While cooking with auto and manual function, you can increase or decrease the cooking time at any point by pressing the button (except defrost mode).</li> </ul>
<b>6 STOP / CANCEL</b>	<ul style="list-style-type: none"> <li>• Stop over and clear all entries except time of day.</li> </ul>
<b>7 START</b>	<ul style="list-style-type: none"> <li>• In order to start cooking which is selected, press button one time.</li> <li>• The quick start feature allows you to set 30 seconds intervals of HIGH power cooking with a press of the START button.</li> </ul>
<b>8 SMART DIAGNOSIS</b>	Hold the mouthpiece of a phone up to this icon when directed to by service centre personnel, to help diagnose problems with the microwave oven when calling for service.

## DISPLAY PICTO

Icon	
	When operate Microwave, Show up the icon on the display.
	When operate Inverter Cook / Steam Cook, Show up the icon on the display.
	When operate Inverter Defrost, Show up the icon on the display.
	When you can set More/Less, Show up the icon on the display.
	When you can Cook Start, Show up the icon on the display.
	When you can set Output Power, Show up the icon on the display.
	When you can set Weight, Show up the icon on the display.

## SETTING CLOCK

When your oven is plugged in for the first time or when power resumes after a power interruption, the numbers in the display reset to '12H'.

### Example: To set 11:11

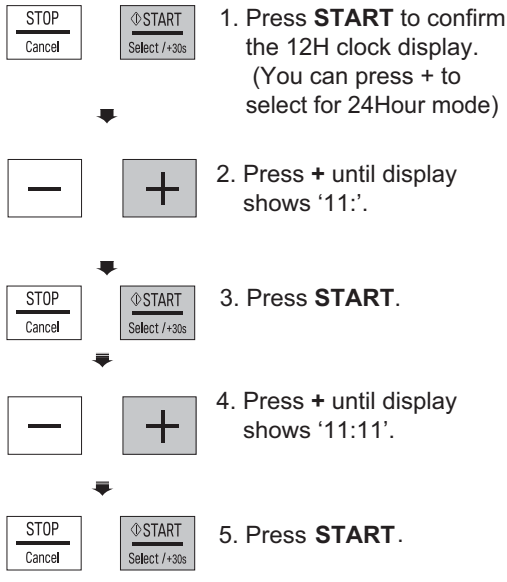

### NOTE

- If you want to set the clock again or change options, you will need to unplug the power cord and reconnect.
- If you don't want to use clock mode, Press STOP/CANCEL button, after plugging in your oven.

## QUICK START

The QUICK START feature allows you to set 30 seconds intervals of HIGH power cooking with a touch of the START.

### Example: Set 2 minutes of cooking on high power

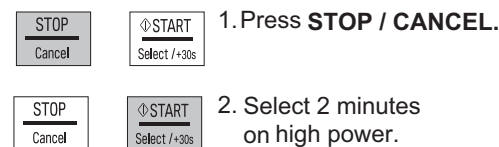

Press the **START** button four times

The oven will start before you have finished the fourth press.

During QUICK START cooking, you can extend the cooking time up to 99 minutes 59 seconds by repeatedly pressing the **START** button.

## MORE/LESS

By using the — or + buttons, TIMED COOK program can be adjusted to cook food for a longer or shorter time. Pressing + will increase 10 seconds to the cooking time each time you press it. Pressing — will decrease 10 seconds of cooking time each time you press it. The max time possible will be 99 minutes 59 seconds.

### Example: To adjust the Inverter Cook (ex. Dinner Plate 1 Serve) cooking time for a longer time, or for a shorter time

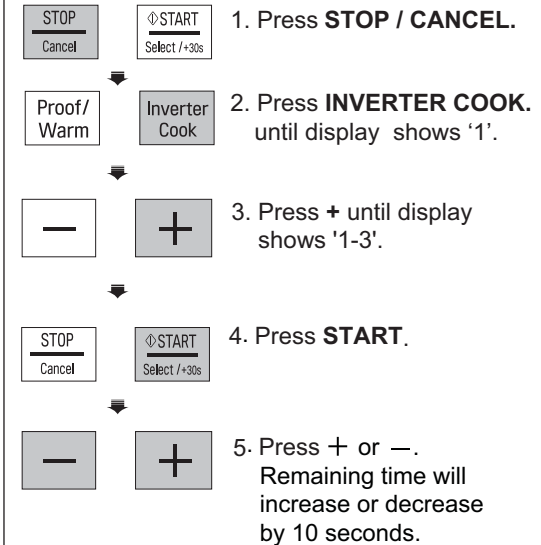

## ENERGY SAVING

Energy saving means save energy by turning off the display. This feature only operates when the Microwave Oven standby and the display will go out.

### NOTE

- When using clock mode, the display will remain on.

## HOW TO USE

### TIMED COOKING (MANUAL COOKING)

This function allows you to cook food for a desired time. There are 5 power levels available. The example below shows how to set 800 W / 1000 W power level for the desired time.

**Example: To cook food on 800 W / 1000 W Power for 5 minutes 30 seconds**

1. Press **STOP / CANCEL**.
2. Press **POWER** until display shows '800 W / 1000 W'. (1st time 1000 W / 1200 W appears in the display. This is to tell you that the oven is set on 1000 W / 1200 W power unless a different power setting is chosen.)
3. Enter 5 minutes 30 seconds by pressing **+** shows '5:30'.
4. Press **START**.

When cooking is complete, Tip will sound. The word End shows in the display window. 'End' remains in the display and Tip will sound every minute until the door is opened, or any button is pressed.

#### NOTE

- If you do not select the power level, the oven will operate at power HIGH. To set HI-POWER cooking, skip step 2 above.

## MICROWAVE POWER LEVELS

Your microwave oven is equipped with five power levels to give you maximum flexibility and control over cooking. The adjacent table will give you some idea of which foods are prepared at each of the various power levels.

- The adjacent chart shows the power level settings for your oven.

### MICROWAVE POWER LEVEL CHART

Power Level		Use
MS253**** MS233****	MS423**** MS363****	
High 1000 W	High 1200 W	<ul style="list-style-type: none"> <li>• Boiling water.</li> <li>• Browning ground beef.</li> <li>• Making candy.</li> <li>• Cooking poultry pieces, fish &amp; vegetables.</li> <li>• Cooking tender cuts of meat.</li> </ul>
800 W	1000 W	<ul style="list-style-type: none"> <li>• Reheating rice, pasta &amp; vegetables.</li> <li>• Reheating prepared foods quickly.</li> <li>• Reheating sandwiches.</li> </ul>
600 W	700 W	<ul style="list-style-type: none"> <li>• Cooking egg, milk and cheese dishes.</li> <li>• Cooking cakes and breads.</li> <li>• Melting chocolate.</li> <li>• Cooking veal.</li> <li>• Cooking whole fish.</li> <li>• Cooking puddings and custard.</li> </ul>
400 W	400 W	<ul style="list-style-type: none"> <li>• Thawing meat, poultry and seafood.</li> <li>• Cooking less tender cuts of meat.</li> </ul>
200 W	200 W	<ul style="list-style-type: none"> <li>• Taking chill out of fruit.</li> <li>• Keeping casseroles and main dishes warm.</li> <li>• Softening butter and cream cheese.</li> </ul>

## CHILD LOCK

This is a unique safety feature that prevents unwanted oven operations. Once the CHILD LOCK is set, no cooking can take place.

### Example: To set the CHILD LOCK

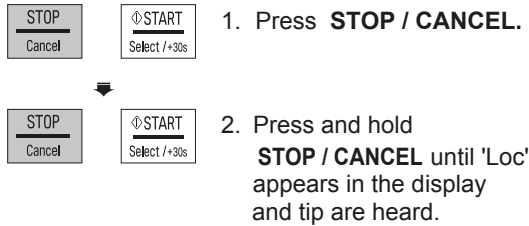
- 
1. Press **STOP / CANCEL**.
  2. Press and hold **STOP / CANCEL** until 'Loc' appears in the display and tip are heard.

If the time of day was already set, the time of day will appear on the display window after 1 second.

If the CHILD LOCK was already set and you touch another pad, the word Loc shows in the display. You can cancel the CHILD LOCK according to below procedure.

### Example: To cancel the CHILD LOCK

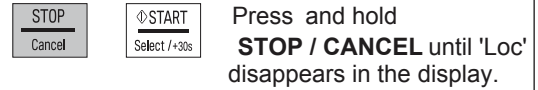
- 
- Press and hold **STOP / CANCEL** until 'Loc' disappears in the display.

After the CHILD LOCK is turned off, the oven will operate normally.

## REHEAT

Your oven's menu has been preprogrammed to automatically reheat food. Tell the oven what you want and how many items there are. Then let your microwave oven reheat your selections.

### Example: To reheat 0.3 kg Pizza

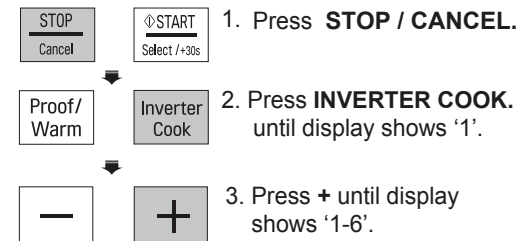
- 
1. Press **STOP / CANCEL**.
  2. Press **INVERTER COOK** until display shows '1'.
  3. Press **+** until display shows '1-6'.

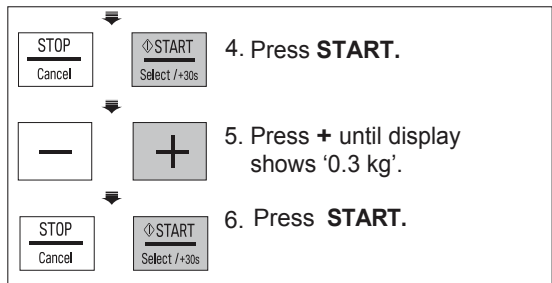
- 
4. Press **START**.
  5. Press **+** until display shows '0.3 kg'.
  6. Press **START**.

## REHEAT MENU INSTRUCTIONS

Code	Menu	Weight Limit	Initial Temperature	Instructions	Utensil
1-1	<b>Beverage</b>	1 - 2 cups (1 cup / 200 ml)	Room	1. Place food on a microwave-safe cup. 2. Place food in the oven. Choose the menu and weight, press START.	Microwave-safe cup
1-2	<b>Casserole</b>	0.25 - 1.0 kg (250 g / 1 serving)	Refrigerated	1. Place food on a microwave-safe bowl. Cover with plastic wrap and vent. 2. Place food in the oven. Choose the menu and weight, press START. 3. After cooking, stand covered for 3 minutes.	Microwave-safe bowl
1-3	<b>Dinner Plate</b>	1	Refrigerated	1. Place food (0.4 - 0.5 kg of meat, chicken, mashed potato, vegetable etc.) on a microwave-safe dish. Cover with plastic wrap and vent. 2. Place food in the oven. Choose the menu, press START. 3. After cooking, stand covered for 3 minutes.	Microwave-safe dish
1-4	<b>Muffin</b>	1 - 4 ea (75 - 80 g / 1 muffin)	Frozen	1. Place food on a microwave-safe dish. 2. Place food in the oven. Choose the menu and weight, press START.	Microwave-safe dish

Code	Menu	Weight Limit	Initial Temperature	Instructions	Utensil
1-5	Pie	0.2 - 0.6 kg (150 - 200 g / piece)	Refrigerated	1. Cut leftover pie into pieces. 2. Place food on a microwave-safe dish. 3. Place food in the oven. Choose the menu and weight, press START.	Microwave-safe dish
1-6	Pizza	0.2 - 0.5 kg	Refrigerated	1. Place food on a microwave-safe dish. 2. Place food in the oven. Choose the menu and weight, press START.	Microwave-safe dish
1-7	Rice	0.1 - 0.3 kg	Refrigerated	1. Place food on a microwave-safe bowl. Cover with plastic wrap and vent. 2. Place food in the oven. Choose the menu and weight, press START. 3. After cooking, stand covered for 3 minutes.	Microwave-safe bowl
1-8	Soup	0.25 - 1.0 kg (250 g / 1 serving)	Room	1. Place food on a microwave-safe bowl. Cover with plastic wrap and vent. 2. Place food in the oven. Choose the menu and weight, press START. 3. After cooking, stand covered for 3 minutes.	Microwave-safe bowl

## POPULAR MENU

Your oven's menu has been preprogrammed to automatically cook food. Tell the oven what you want and how many items there are. Then let your microwave oven cook your selections.

**Example: To cook 0.3 kg Dum Aloo**

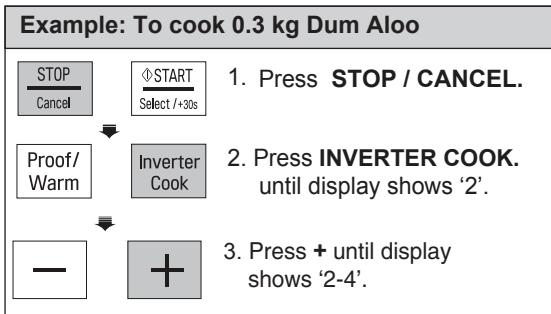

1. Press **STOP / CANCEL**.
2. Press **INVERTER COOK** until display shows '2'.
3. Press **+** until display shows '2-4'.

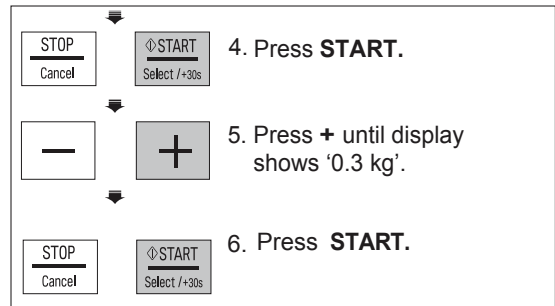

4. Press **START**.
5. Press **+** until display shows '0.3 kg'.
6. Press **START**.

## POPULAR MENU INSTRUCTIONS

Code	Menu	Weight Limit	Initial Temperature	Instructions	Utensil
2-1	Chicken Clear Soup	1.0 kg	Refrigerated	<div style="border: 1px solid black; padding: 5px; margin-bottom: 10px;"> <p><b>Ingredients</b></p> <p>300 g chicken legs                      ½ carrot, peeled and large cut                      1 potato, peeled and large cut                      ½ onion, large cut                      2 celeries, cut 1 inch                      3 cups chicken stock                      ½ teaspoon salt                      ¼ teaspoon pepper powder</p> </div> <ol style="list-style-type: none"> <li>1. Clean chicken legs, cut to large pieces and drain.</li> <li>2. In a microwave-safe bowl, put the all ingredients.</li> <li>3. Place food in the oven. Choose the menu, press START.</li> </ol>	Microwave-safe bowl

Code	Menu	Weight Limit	Initial Temperature	Instructions	Utensil
2-2	Curry Chicken	1.5 kg	Room	<p><b>Ingredients</b>            400 g chicken breasts, cut into chunks /            ¼ cup olive oil / 2 onions, chopped            4 garlic cloves, crushed /            1 ginger root, peeled /            1 cinnamon stick / 2 dried red chilies /            1 teaspoon turmeric powder /            400 g tomato sauce /            ½ cup water or stock / ½ cup plain yogurt /            1 tablespoon lemon juice /            Salt and pepper to taste</p> <ol style="list-style-type: none"> <li>1. Add all ingredients in a deep and large microwave-safe bowl and mix well. Cover with plastic wrap and vent.</li> <li>2. Place food in the oven. Choose the menu, press START.</li> <li>3. Stir at least twice during cooking.</li> </ol>	Microwave-safe bowl
2-3	Dolma	1.0 kg	Room	<p><b>Ingredients</b>            1 pot of grape leaves            200 g cooked rice            500 g ground beef            1 onion, chopped            Salt and pepper to taste            ½ cup water</p> <ol style="list-style-type: none"> <li>1. Add cooked rice, ground beef, onion, salt and pepper in a bowl and mix well.</li> <li>2. Place grape leaves on a flat surface and place 1 ½ spoonfuls of the rice mixture in the center of the leaf. Wrap rice mixture with leaf.</li> <li>3. Put all wrapped leaves in rows into a deep and large microwave-safe bowl and add water. Cover with plastic wrap and vent.</li> <li>4. Place food in the oven. Choose the menu, press START.</li> <li>5. After cooking, serve with sour cream or as desired.</li> </ol>	Microwave-safe bowl

Code	Menu	Weight Limit	Initial Temperature	Instructions	Utensil																																								
2-4	Dum Aloo	0.1 - 0.3 kg	Room	<p><b>Ingredients</b></p> <table border="1" data-bbox="621 278 1098 643"> <thead> <tr> <th></th> <th>0.1 kg</th> <th>0.2 kg</th> <th>0.3 kg</th> </tr> </thead> <tbody> <tr> <td>Aloo(small &amp; pricked)</td> <td>100 g</td> <td>200 g</td> <td>300 g</td> </tr> <tr> <td>Oil</td> <td>2 tbsps</td> <td>3 tbsps</td> <td>3 tbsps</td> </tr> <tr> <td>Cumin, pepper, cloves</td> <td></td> <td></td> <td></td> </tr> <tr> <td>Onion paste</td> <td>1 tbsps</td> <td>1 ½ tbsps</td> <td>1 ½ tbsps</td> </tr> <tr> <td>Ginger garlic paste</td> <td>1 tsp</td> <td>1 ½ tpsps</td> <td>1 ½ tpsps</td> </tr> <tr> <td>Tomato puree</td> <td>1 tbsps</td> <td>2 tbsps</td> <td>3 tbsps</td> </tr> <tr> <td>Curd</td> <td>½ cup</td> <td>1 cup</td> <td>1 cup</td> </tr> <tr> <td>Turmeric powder, red chili powder, salt,</td> <td colspan="3">To taste</td> </tr> <tr> <td>Coriander leaves</td> <td colspan="3">To garnish</td> </tr> </tbody> </table> <ol data-bbox="614 653 1122 929" style="list-style-type: none"> <li>In a microwave-safe bowl, put small pricked potatoes with oil(½ the amount mentioned per weight) and cover.</li> <li>Choose the menu and weight, press START.</li> <li>When BEEP, add oil(remaining half amount) cumin, pepper, cloves, onion paste, ginger garlic paste, tomato puree. And then press START to continue cooking.</li> <li>When BEEP, add a curd, turmeric powder, red chili powder, salt and coriander leaves. And then press start to continue cooking.</li> <li>After cooking, stand for 3 minutes. Garnish with coriander leaves.</li> </ol>		0.1 kg	0.2 kg	0.3 kg	Aloo(small & pricked)	100 g	200 g	300 g	Oil	2 tbsps	3 tbsps	3 tbsps	Cumin, pepper, cloves				Onion paste	1 tbsps	1 ½ tbsps	1 ½ tbsps	Ginger garlic paste	1 tsp	1 ½ tpsps	1 ½ tpsps	Tomato puree	1 tbsps	2 tbsps	3 tbsps	Curd	½ cup	1 cup	1 cup	Turmeric powder, red chili powder, salt,	To taste			Coriander leaves	To garnish			Microwave-safe bowl
	0.1 kg	0.2 kg	0.3 kg																																										
Aloo(small & pricked)	100 g	200 g	300 g																																										
Oil	2 tbsps	3 tbsps	3 tbsps																																										
Cumin, pepper, cloves																																													
Onion paste	1 tbsps	1 ½ tbsps	1 ½ tbsps																																										
Ginger garlic paste	1 tsp	1 ½ tpsps	1 ½ tpsps																																										
Tomato puree	1 tbsps	2 tbsps	3 tbsps																																										
Curd	½ cup	1 cup	1 cup																																										
Turmeric powder, red chili powder, salt,	To taste																																												
Coriander leaves	To garnish																																												
2-5	Fish ball and Thai Herbs Spicy Soup	1.0 kg	Room	<p><b>Ingredients</b></p> <p data-bbox="642 1006 1085 1286">200 g featherback fish, minced 2 tablespoons curry paste 4 Thai eggplants, quarter 1 each red and yellow chili spur pepper, sliced 2 bunches fresh pepper corn ¼ cup krachai, thin sliced 5 kaffir lime leaves, teared ¼ cup holy basil 2 teaspoons fish sauce 1 teaspoon coconut sugar 3 cups water</p> <ol data-bbox="614 1306 1071 1450" style="list-style-type: none"> <li>Squeeze the featherback fish with a touch of salt and water, until it becomes sticky. Set aside.</li> <li>In a large microwave-safe bowl, put the fish ball and all ingredients.</li> <li>Place food in the oven. Choose the menu, press START.</li> </ol>	Microwave-safe bowl																																								

Code	Menu	Weight Limit	Initial Temperature	Instructions	Utensil
2-6	Stewed Pork belly	1.2 kg	Room	<p><b>Ingredients</b></p> <p>300 g pork belly(less fat)  4 star anises  3 cinnamon sticks, cut 1 inch  5 garlics, crushed  2 teaspoons pepper corn  2 coriander roots, crushed  4 cups pork stock  2 tablespoons coconut sugar  2 tablespoons soy sauce  2 tablespoons dark soy sauce  2 tablespoons seasoning sauce  Cheesecloth for wrap the spices</p> <p>1.Clean pork belly, cut into the pieces about 3 cm pieces.  2. In a large microwave-safe bowl, put the pork belly and all ingredients.  3. Place food in the oven. Choose the menu, press START.</p>	Microwave-safe bowl
2-7	Stir-fried Squid with Curry Powder	0.6 kg	Room	<p><b>Ingredients</b></p> <p>300 g squids  ½ onion, sliced  2 red spur peppers, sliced  2 Chinese celeries, cut 2 inches  2 spring onions, cut 2 inches  2 tablespoons curry powder  1 egg  3 tablespoons unsweetened condensed milk  2 tablespoons oyster sauce  2 teaspoons sugar  2 tablespoons chili paste  2 tablespoons cooking oil</p> <p>1. Remove the head, tentacles and ink-sac from the squid. Pull off and discard the mottled skin. Slice flesh to stripe and cut into cubes, drain.  2. Mix all the ingredients except vegetables and oil.  3. In a microwave-safe bowl, put the mixture, vegetables, oil and squids.  4. Place food in the oven. Choose the menu, press START. Stir at least twice during cooking.</p>	Microwave-safe dish
2-8	Veg. Biryani	1.0 kg	Room	<p><b>Ingredients</b></p> <p>1 ½ cups basmati rice / 400 g water /  2 cups chopped onions /1 tomato, chopped /  1 cup vegetables(carrot, beans, peas, potato),  chopped / 2 green chillies, chopped  1 teaspoon ginger garlic paste /  1 ½ teaspoon red chili powder /  1 teaspoon coriander powder /  1 teaspoon cumin powder /  1 tablespoon biryani masala /  1 cinnamon / 2 cardamoms  2 cloves / 2 small bay leaves  1 teaspoon fennel seeds /  A bunch of finely chopped coriander leaves  (cilantro) and mint leaves /  1 tablespoon oil /  2 tablespoons ghee or clarified butter /  Salt to taste</p> <p>1.Cook all vegetables and spices in a lightly oiled frying pan until lightly browned.  2.Place the cooked vegetable mixture into a deep and large microwave-safe bowl and add rice and water. Cover with plastic wrap and vent.  3.Place food in the oven. Choose the menu, press START. Stir at least twice during cooking.</p>	Microwave-safe bowl

## SOFTEN

The oven uses low power to soften foods (butter, cream cheese and ice cream) See the following table.

**Example: To Soften 0.2 kg Cream Cheese.**

1. Press **STOP / CANCEL**.

2. Press **INVERTER COOK** until display show '3'.

3. Press **+** until display show '3-2'.

4. Press **START**.

5. Press **+** until display show '0.2 kg'.

6. Press **START**.

## SOFTEN MENU INSTRUCTIONS

Code	Menu	Weight Limit	Initial Temperature	Instructions	Utensil
3-1	<b>Butter</b>	1 - 3 ea (100 - 150 g / each)	Refrigerated	1. Unwrap and place on a microwave-safe dish. 2. Place food in the oven. Choose the menu and weight, press START. 3. Butter will be at room temperature and ready for use in a recipe.	Microwave-safe dish
3-2	<b>Cream Cheese</b>	0.1 - 0.3 kg	Refrigerated	1. Unwrap and place on a microwave-safe dish. 2. Place food in the oven. Choose the menu and weight, press START. 3. Cream cheese will be at room temperature and ready for use in a recipe.	Microwave-safe dish
3-3	<b>Ice Cream</b>	2 / 4 cups	Frozen	1. Remove lid and cover. 2. Place food in the oven. Choose the menu and weight, press START. 3. Ice cream will be soft enough to make scooping easier.	

# MELT

The oven uses low power to melt foods (butter, cheese and chocolate). See the following table.

**Example: To Melt 0.2 kg Chocolate**

1. Press **STOP / CANCEL**.

2. Press **INVERTER COOK** until display show '4'.

3. Press **+** until display show '4-3'.

4. Press **START**.

5. Press **+** until display show '0.2 kg'.

6. Press **START**.

## MELT MENU INSTRUCTIONS

Code	Menu	Weight Limit	Initial Temperature	Instructions	Utensil
4-1	<b>Butter</b>	1 - 3 ea (100 - 150 g / each)	Refrigerated	1. Place on a microwave-safe bowl. 2. Place food in the oven. Choose the menu and weight, press <b>START</b> . 3. After cooking, stir to complete melting.	Microwave-safe bowl
4-2	<b>Cheese</b>	0.2 - 0.4 kg	Refrigerated	1. Use processed cheese food only. Unwrap and cut into cubes. 2. Place on a microwave-safe bowl. 3. Place food in the oven. Choose the menu and weight, press <b>START</b> . 4. After cooking, stir to complete melting.	Microwave-safe bowl
4-3	<b>Chocolate</b>	0.1 - 0.3 kg	Room	1. Chocolate chips or squares of baking chocolate may be used. 2. Unwrap and place on a microwave-safe bowl. 3. Place food in the oven. Choose the menu and weight, press <b>START</b> . 4. After cooking, stir to complete melting.	Microwave-safe bowl

## PROOF

This feature allows you to cook Yogurt by pressing Proof/Warm button.

**Example: To Cook 0.6 kg Yogurt.**

1. Press **STOP / CANCEL**.

2. Press **PROOF / WARM** until display shows "1"

3. Press **START**.  
'5h00' will show in the display.

## PROOF MENU INSTRUCTIONS

Code	Menu	Weight Limit	Initial Temperature	Instructions	Utensil												
1	Yogurt	0.6 kg	Lukewarm	<p><b>Ingredients</b></p> <p>500 ml pasteurized whole milk 100 g natural plain yogurt</p> <ol style="list-style-type: none"> <li>Thoroughly wash the proper sized microwave-safe bowl with hot water.</li> <li>Pour 500 ml milk into the bowl.</li> <li>Heat it about 1 minute 30 seconds - 2 minutes 30 seconds on high microwave power until 40 - 50 °C temperature.</li> <li>Add 100 ml yogurt into the bowl and stir well.</li> <li>Cover with plastic wrap or lid and place food in the oven. Choose the menu, press START.</li> <li>After proofing, stand in the refrigerator for about 5 hours.</li> <li>Taste nice with jam, sugar or fruits.</li> </ol> <p>Note :</p> <ul style="list-style-type: none"> <li>The following types of milk and yogurt may be used :</li> </ul> <table border="1"> <thead> <tr> <th colspan="2">Do use</th> <th colspan="2">Do not use</th> </tr> <tr> <th>Milk</th> <th>Yogurt</th> <th>Milk</th> <th>Yogurt</th> </tr> </thead> <tbody> <tr> <td>· Pasteurized whole milk</td> <td>· Natural plain yogurt</td> <td>· 2 %, 1 % or fat-free milk · High calcium milk · Soy milk · Leftover milk · Expired milk</td> <td>· Leftover yogurt · Expired yogurt</td> </tr> </tbody> </table> <ul style="list-style-type: none"> <li>Thoroughly wash all utensils with hot water and dry before proofing yogurt.</li> <li>Make sure that the milk is lukewarm(40 - 50 °C) before proofing.</li> <li>Don't shake or mix yogurt during proofing as this will affect the firmness of the yogurt.</li> <li>If the amount of ingredients are greater than suggested, increase the proofing time.</li> </ul>	Do use		Do not use		Milk	Yogurt	Milk	Yogurt	· Pasteurized whole milk	· Natural plain yogurt	· 2 %, 1 % or fat-free milk · High calcium milk · Soy milk · Leftover milk · Expired milk	· Leftover yogurt · Expired yogurt	Microwave-safe bowl
Do use		Do not use															
Milk	Yogurt	Milk	Yogurt														
· Pasteurized whole milk	· Natural plain yogurt	· 2 %, 1 % or fat-free milk · High calcium milk · Soy milk · Leftover milk · Expired milk	· Leftover yogurt · Expired yogurt														

## KEEP WARM

The Keep Warm function will keep hot, cooked food at serving temperature. Always start with hot food. Use microwave-safe utensils.

### Example: Keep warm manually To warm food at high level in 90 minutes

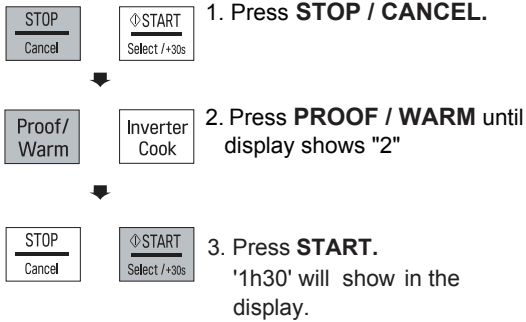

#### Notes :

Crisp foods (pastry, pies, turnovers, etc) should be uncovered during keep warm. Moist foods should be covered with plastic wrap or microwave-safe lid. The amount of keep warm food is suitable for 1-3 servings.

## INVERTER DEFROST

Four defrost sequences are preset in the oven. The INVERTER DEFROST feature provides you with the best defrosting method for frozen foods. The cooking guide will show you which defrost sequence is recommended for the food you are defrosting.

For added convenience, the INVERTER DEFROST includes a built-in beep mechanism that reminds you to check, turn over, separate, or rearrange to get the best defrost results. Four defrosting levels are provided.

(MEAT / POULTRY / FISH / BREAD)

**Example: To defrost 1.2 kg of meat**

1. Press **STOP / CANCEL**.

2. Press **INVERTER DEFROST** until display shows 'dEF1'.

3. Press **+** until display shows '1.2 kg'.

4. Press **START**.

### NOTE:

When you press the **START** button, the display changes to defrost time count down. The oven will beep once during the DEFROST cycle.

At beep, open the door and remove any portions that have thawed and turn.

Return frozen portions to the oven and press **START** to resume the defrost cycle.

- Remove fish, meat, and poultry from its original wrapping paper or plastic package. Otherwise, the wrap will hold steam and juice close to the foods, which can cause the outer surface of the foods to cook.
- Place foods in a shallow container or on a microwave roasting rack to catch drippings.
- Food should still be somewhat icy in the center when removed from the oven.
- The length of defrosting time varies according to how solidly the food is frozen.
- The shape of the package affects how quickly food will defrost. Shallow packages will defrost more quickly than a deep block.
- Depending on the shape of the food can be defrosted more or less.

## INVERTER DEFROST MENU INSTRUCTIONS

Category	Food to be Defrosted
<b>MEAT</b> (dEF1) 0.1 - 4.0 kg	<b>Beef</b> Ground beef, Round steak, Cubes for stew, Tenderloin steak, Pot roast, Rib roast, Rump roast, Chuck roast, Hamburger patty Remove any defrosted portion of ground beef at the beeps.
	<b>Lamb</b> Chops, Rolled roast <b>Pork</b> Chops, Hot dogs, Spareribs, Country-style ribs, Rolled roast, Sausage <b>Veal</b> Cutlets (0.5 kg, 20 mm thick) Turn food over at beep. After defrosting, let stand for 5 - 15 minutes.
<b>POULTRY</b> (dEF2) 0.1 - 4.0 kg	<b>Poultry</b> Whole, Cut-up, Breast (boneless). Rinse chicken cavity with tap water and let stand for 60 minutes for better performance.
	<b>Cornish Hens</b> Whole <b>Turkey</b> Breast Turn food over at beep. After defrosting, rinse with cold water after 30 minutes, let stand for 60 minutes.
<b>FISH</b> (dEF3) 0.1 - 4.0 kg	<b>Fish</b> Fillets, Whole Steaks <b>Shellfish</b> Crab meat, Lobster tails, Shrimp, Scallops Turn food over at beep. Separate portions if needed. After defrosting, let stand for 5 - 10 minutes.
	<b>BREAD</b> (dEF4) 0.1 - 0.5 kg Sliced bread, Buns, Baguette, etc. Separate slices and place between paper towel or flat plate. Turn food over at beep. After defrosting, let stand for 1 - 2 minutes.

# MICROWAVE-SAFE UTENSILS

## Never use metal or metal trimmed utensils in using microwave function

Microwaves cannot penetrate metal. They will bounce off any metal object in the oven and cause arcing, an alarming phenomenon that resembles lightning. Most heat resistant non metallic cooking utensils are safe for use in your oven. However, some may contain materials that render them unsuitable as microwave cookware. If you have any doubts about a particular utensil, there's a simple way to find out if it can be used in the microwave.

Place the utensil in question next to a glass bowl filled with water in using microwave function. Microwave at power HIGH for 1 minute. If the water heats up but the utensil remains cool to the touch, the utensil is microwave-safe. However, if the water does not change temperature but the utensil becomes warm, microwaves are being absorbed by the utensil and it is not safe for use in using microwave function. You probably have many items on hand in your kitchen right now that can be used as cooking equipment in the microwave. Just read through the following checklist.

## Dinner plates

Many kinds of dinnerware are microwave-safe. If in doubt consult the manufacturer's literature or perform the microwave test. Do not heat dinner plates that use any painted on decorative as they will arc if the paint has metallic content.

## Glassware

Glassware that is heat-resistant is microwave-safe. This would include all brands of oven tempered glass cookware. However, do not use delicate glassware, such as tumblers or wine glasses, as these might shatter as the food warms.

## Plastic storage containers

These can be used to hold foods that are to be quickly reheated. However, they should not be used to hold foods that will need considerable time in the oven as hot foods will eventually warp or melt plastic containers.

## Paper

Paper plates and containers are convenient and safe to use in using microwave function, provided that the cooking time is short and foods to be cooked are low in fat and moisture. Paper towels are also very useful for wrapping foods and for lining baking trays in which greasy foods such as bacon are cooked. In general, avoid coloured paper products as the colour may run. Some recycled paper products may contain impurities which could cause arcing or fires when used in the microwave.

## Plastic cooking bags

Provided they are made specially for cooking, cooking bags are microwave safe. However, be sure to make a slit in the bag so that steam can escape. Never use ordinary plastic bags for cooking in using microwave function, as they will melt and rupture.

## Plastic microwave cookware

A variety of shapes and sizes of microwave cookware are available. For the most part, you can probably use items you already have on hand rather than investing in new kitchen equipment.

## Pottery, stoneware and ceramic

Containers made of these materials are usually fine for use in using microwave function, but they should be tested to be sure.



### CAUTION

- Some items with high lead or iron content are not suitable as cooking utensils.
- Utensils should be checked to ensure that they are suitable for use in the microwave.

# FOOD CHARACTERISTICS & MICROWAVE COOKING

## Keeping an eye on things

Always watch your food while it cooks. Your microwave function is equipped with a light that turns on automatically when the oven is in operation so that you can see inside and check the progress of your food. Directions given in recipes to elevate, stir, and the like should be thought of as the minimum steps recommended. If the food seems to be cooking unevenly, simply make the necessary adjustments you think appropriate to correct the problem.

## Factors affecting microwave cooking times

Many factors affect cooking times. The temperature of ingredients used in a recipe makes a big difference in cooking times. For example, a cake made with ice-cold butter, milk, and eggs will take considerably longer to bake than one made with ingredients that are at room temperature. Some of the recipes, particularly those for bread, cake, and custards, recommend that food be removed from the oven when they are slightly undercooked.

This is not a mistake. When allowed to stand, usually covered, these foods will continue to cook outside of the oven as the heat trapped within the outer portions of the food gradually travels inward. If the food is left in the oven until it is cooked all the way through, the outer portions will become overcooked or even burnt. You will become increasingly skillful in estimating both cooking and standing times for various foods.

## Density of food

Light, porous food such as cakes and breads cook more quickly than heavy, dense foods such as roasts and casseroles. You must take care when microwaving porous food so that the outer edges do not become dry and brittle.

## Height of food

The upper portion of tall foods, particularly roasts, will cook more quickly than the lower portion. Therefore, it is wise to turn tall food several during cooking.

## Moisture content of food

Since the heat generated from microwaves causes moisture to evaporate, relatively dry food such as roasts and some vegetables should either be sprinkled with water prior to cooking or covered to retain moisture.

## Bone and fat content of food

Bones conduct heat and fat cooks more quickly than meat. Care must be taken when cooking bony or fatty cuts of meat in order to prevent unevenly or overcooked meat.

## Quantity of food

The number of microwaves in your oven remains constant regardless of how much food is being cooked. Therefore, the more food you place in the oven, the longer the cooking time. Remember to decrease cooking times by at least one third when halving a recipe.

## Shape of food

Microwaves penetrate only about 2 cm into food, the interior portion of thick foods are cooked as the heat generated on the outside travels inward. Only the outer edge of food is cooked by microwave energy; the rest is cooked by conduction. The worst possible shape for a food that is to be microwaved is a thick square.

The corners will burn long before the centre is even warm. Round thin foods and ring shaped foods cook most successfully in the microwave.

## Covering

A cover traps heat and steam which causes food to cook more quickly. Use a lid or microwave cling film with a corner folded back to prevent splitting.

# FOOD CHARACTERISTICS & MICROWAVE COOKING

## Browning

Meats and poultry that are cooked fifteen minutes or longer will brown lightly in their own fat. Foods that are cooked for a shorter period of time may be brushed with a browning sauce such as Worcestershire sauce, soy sauce or barbecue sauce to achieve an appetizing colour. Since relatively small amounts of browning sauces are added to food, the original flavour of the recipe is not altered.

## Covering with greaseproof paper

It is a looser cover than a lid or cling film, the food may dry out slightly. But because it makes a looser cover than a lid or clingfilm, it allows the food to dry out slightly.

## Arranging and spacing

Individual foods such as baked potatoes, small cakes and hors d'oeuvres will heat more evenly if placed in the oven an equal distance apart, preferably in a circular pattern. Never stack foods on top of one another.

## Stirring

Stirring is one of the most important of all microwaving techniques. In conventional cooking, food is stirred for the purpose of blending. Microwaved food, however, is stirred in order to spread and redistribute heat. Always stir from the outside towards the centre as the outside of the food heats first.

## Turning over

Large, tall foods such as roasts and whole chickens should be turned so that the top and bottom will cook evenly. It is also a good idea to turn cut up chicken and chops.

## Placing thicker portions facing outwards

Since microwaves are attracted to the outside portion of food, it makes sense to place thicker portions of meat, poultry and fish to the outer edge of the baking dish. This way, thicker portions will receive the most microwave energy and the food will cook evenly.

## Shielding

Strips of aluminium foil (which block microwaves) can be placed over the corners or edges of square and rectangular foods to prevent those portions from overcooking. Never use too much foil and make sure the foil is secured to the dish or it may cause 'arcing' in the oven especially if the foil passes too closely to the walls of the oven during rotation.

## Elevating

Thick or dense foods can be elevated so that microwaves can be absorbed by the underside and centre of the foods.

## Piercing

Foods enclosed in a shell, skin or membrane are likely to burst in the oven unless they are pierced prior to cooking. Such foods include yolks and whites of eggs, clams and oysters and whole vegetables and fruits.

## Testing if cooked

Food cooks so quickly in a oven, it is necessary to test it frequently. Some foods are left in the microwave until completely cooked, but most foods, including meats and poultry, are removed from the oven while still slightly undercooked and allowed to finish cooking during standing time. The internal temperature of foods will rise between 5°F (3°C) and 150°F (80°C) during standing time.

## Standing time

Foods are often allowed to stand for 3 to 10 minutes after being removed from the oven. Usually the foods are covered during standing time to retain heat unless they are supposed to be dry in texture (some cakes and biscuits, for example). Standing allows foods to finish cooking and also helps flavour blend and develop.

## TO CLEAN YOUR OVEN

### 1 Keep the inside of the oven clean

Food spatters or spilled liquids stick to oven walls and between the seal and door surfaces. It is best to wipe up spillovers with a damp cloth right away. Crumbs and spillovers will absorb microwave energy and lengthen cooking times and may even damage the oven. Use a damp cloth to wipe out crumbs that fall between the door and the frame. It is important to keep this area clean to assure a tight seal. Remove greasy spatters with a soapy cloth then rinse and dry. Do not use harsh detergent or abrasive cleaners. The metal tray can be washed by hand or in the dishwasher.

### 2 Keep the outside of the oven clean

Disconnect the mains plug from the power outlet before cleaning the oven to eliminate the possibility of electric shock. Clean the outside of your oven with soap and water then with clean water and dry with a soft cloth or paper towel. To prevent damage to the operating parts inside the oven, the water should not be allowed to seep into the ventilation openings. To clean control panel, open the door to prevent the oven from accidentally starting, and wipe a damp cloth followed immediately by a dry cloth. Press STOP after cleaning.

3 If steam accumulates inside or around the outside of the oven door, wipe the panels with a soft cloth. Steam or condensation build up inside the door is normal if foods are heated for a long period on higher power levels, this is not a malfunction, the condensation will eventually evaporate. Try covering the food or vary the heating levels and time to reduce any condensation forming in the door, this may also occur when the oven is operated under high humidity conditions and in no way indicates a malfunction of the unit.

4 The door and door seals should be kept clean. Use only warm, soapy water, rinse then dry thoroughly. DO NOT USE ABRASIVE MATERIALS, SUCH AS CLEANING POWDERS OR STEEL AND PLASTIC PADS. Metal parts will be easier to maintain if wiped frequently with a damp cloth.

## USING THE SMART DIAGNOSIS™ FUNCTION

Use this function if you need an accurate diagnosis by an LG Electronics service centre when the product malfunctions or fails. Use this function only to contact the service representative, not during normal operation

1. When instructed to do so by the call centre, hold the mouthpiece of your phone over the Smart Diagnosis™ logo on the controller.

#### ! NOTE

- Do not touch any other buttons.

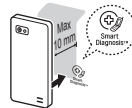

2. With the door closed, press and continue to hold the STOP/Clear button for 3 seconds so that 'Loc' appears on the display. Continue to hold the STOP/Clear button for a further 5 seconds until '5' appears in the display, (so, the STOP/Clear button will need to be held for 8 seconds continuously). A tone will then emit from behind the Smart Diagnosis symbol.

3. Keep the phone in place until the tone transmission has finished. The display will count down the time.

4. Once the countdown is over and the tones have stopped, resume your conversation with the call center agent, who will then be able to assist you in using the information transmitted for analysis.

#### ! NOTE

- For best results, do not move the phone while the tones are being transmitted.
- If the call center agent is not able to get an accurate recording of the data, you may be asked to try again.

## QUESTIONS & ANSWERS

FAQ	Answer
What's wrong when the oven light will not glow?	There may be several reasons why the oven light will not glow. Either the light bulb has blown or the electric circuit has failed.
Does microwave energy pass through the viewing screen in the door?	No. The holes, or ports, are made to allow light to pass; they do not let microwave energy through.
Why does the BEEP tone sound when a button on the control panel is touched?	The BEEP tone sounds to assure that the setting is being properly entered.
Will the microwave function be damaged if it operates empty?	Yes. Never run it empty.
Why do eggs sometimes pop?	When baking, frying, or poaching eggs, the yolk may pop due to steam build up inside the yolk membrane. To prevent this, simply pierce the yolk before cooking. Never microwave eggs in the shell.
Why is standing time recommended after microwave cooking is over?	After microwave cooking is finished, food keeps on cooking during standing time. This standing time finishes cooking evenly throughout the food. The amount of standing time depends on the density of the food.
Why doesn't my oven always cook as fast as the cooking guide says?	Check your cooking guide again to make sure you've followed directions correctly, and to see what might cause variations in cooking time. Cooking guide times and heat settings are suggestions, chosen to help prevent overcooking, the most common problem in getting used to this oven. Variations in the size, shape, weight and dimensions of the food require longer cooking time. Use your own judgment along with the cooking guide suggestions to test food conditions, just as you would do with a conventional cooker.
Why appears the word 'Cool' or remaining cooking time in the display with fan noise after microwave cooking is over?	After cooking is complete, the fan may operate to cool the oven. The display will show 'Cool'. If you open the door or press once STOP/CLEAR before the cooking time is complete, the remaining cooking time will show on the display. This is not a malfunction.

When operating the microwave oven, If you use a product such as radio, TV, wireless LAN, Bluetooth, medical equipment, wireless equipment etc Using the same frequency as the microwave oven, the product may receive interference from these products. This interference does not indicate a problem of the microwave or the product and is not a malfunction. Therefore, it is safe to use. However, medical equipment may receive interference as well, so use caution when using medical equipment near the product.

## TECHNICAL SPECIFICATIONS

MS253***	
Power Input	230 V~ 50 Hz / 220 V~ 50 Hz
Microwave Output Power.	Max. 1000 W* (IEC60705 rating standard)
Microwave Frequency	2450 MHz
Outside Dimension	476 mm(W) X 272 mm(H) X 368 mm(D)
Microwave	1150 W

MS233***	
Power Input	230 V~ 50 Hz / 220 V~ 50 Hz
Microwave Output Power.	Max. 1000 W* (IEC60705 rating standard)
Microwave Frequency	2450 MHz
Outside Dimension	476 mm(W) X 272 mm(H) X 346 mm(D)
Microwave	1150 W

\* In 1000 W and 800 W, output power will gradually be reduced to avoid overheating.

MS423**** MS363****	
Power Input	230 V~ 50 Hz / 220 V~ 50 Hz
Microwave Output Power.	Max. 1200 W* (IEC60705 rating standard)
Microwave Frequency	2450 MHz
Outside Dimension	544 mm(W) X 307 mm(H) X 439 mm(D)
Microwave	1350 W

\* In 1200 W and 1000 W, output power will gradually be reduced to avoid overheating.

Microwave Frequency : 2450 MHz +/- 50 MHz (Group 2 / Class B)

Group 2 equipment: group 2 contains all ISM RF equipment in which radio-frequency energy in the frequency range 9 kHz to 400 GHz is intentionally generated and used or only used, in the form of electromagnetic radiation, inductive and /or capacitive coupling, for the treatment of material or inspection/analysis purposes.

Class B equipment is equipment suitable for use in domestic establishments and in establishments directly connected to a low voltage power supply network which supplies buildings used for domestic purposes.

You can download a owner's manual at <http://www.lg.com>

