

**FOYDALANUVCHI
QO'LLANMASI
IPS LED Monitor
(LED Monitor*)**

*** LG LED monitorlari LED Orqa yoritgichlik LCD monitordir.**

Iltimos, ishlatishdan oldin ushbu qo'llanmani batafsil o'rganib chiqing va kelajakda ma'lumotlar uchun foydalanish maqsadida saqlab qo'ying.

IPS LED Monitor (LED Monitor) Rusumlar ro'yxati

29WK500

34WK500

MUNDARIJA

3 LITSENZIYA

4 YIG'ISH VA TAYYORLASH

- 4 Mahsulot komponentlari
- 5 Qo'llab-quvvatlanadigan drayverlar va dasturiy ta'minot
- 6 Komponent va Tugma Ta'rifi
- 6 - Joystik tugmasidan foydalanish
- 7 Kirish Ulagichi
- 8 Monitorni joyidan qo'zg'ash va ko'tarish
- 9 Monitorni o'rnatish
- 9 - Tirgak asosini montajlash
- 10 Monitorni o'rnatish
- 10 - Tirgak asosini montajlash
- 12 - Stol ustiga o'rnatish
- 13 - Burchaklarni sozlash
- 15 - Kensington qulfidan foydalanish
- 16 - Tayanch korpusini ajratish
- 16 - Devorga mahkamlash uchun plastinani o'rnatish
- 16 - Devorga o'rnatish

18 MONITORDAN FOYDALANISH

- 18 Shaxsiy kompyuterga ulash
- 18 - HDMI ulanish
- 18 AV qurilmalarga ulash
- 18 - HDMI ulanish
- 19 Tashqi qurilmalar uchun ulanish
- 19 - Quloqliklarni ulash

20 FOYDALANUVCHI SOZLANMALARI

- 20 Asosiy menyuni faollashtirish
- 20 - Asosiy menyu funksiyalari
- 21 Foydalanuvchi sozlanmalari
- 21 - Menyu sozlanmalari

25 NOSOZLIKLARNI TUZATISH

27 XUSUSIYATLAR

- 27 29WK500
- 29 34WK500
- 30 Standart qo'llab-quvvatlash holati (Preset Mode, PC)
- 30 HDMI
- 30 HDMI Sinxronizatsiyasi (Video)
- 31 Quvvat LED

LITSENZIYA

Har bir model turli litsenziyalarga egadir. Litsenziya haqida qo'shimcha ma'lumot olish uchun www.lg.com saytiga tashrif buyuring.



The terms HDMI and HDMI High-Definition Multimedia Interface, and the HDMI Logo are trademarks or registered trademarks of HDMI Licensing Administrator, Inc. in the United States and other countries.

Quyidagi tarkib faqat Evropa bozorida sotib olingan monitorga qo'llaniladi va quvvatni iste'mol qiluvchi qurilmalar bilan bog'lik Yo'riqnomaga oid (Direktivaga)::

* Agar displeyga hech qanday sozlamalar o'rnatilmagan bo'lsa ushbu monitor ulangandan keyin avtomatik ravishda 4 soatdan keyin o'chiriladi.

* Sozlamalarni o'chirish uchun, OSD Menu sahifasida «Avtomatik kutish» rejimida «O'chirish» parametrini o'zgarting.

YIG'ISH VA TAYYORLASH

Mahsulot komponentlari

Iltimos, mahsulotni ishlatishdan oldin barcha komponentlar qutida mavjudligini tekshiring. Yetishmayotgan qismlari mavjud bo'lsa, siz mahsulotni sotib olgan chakana do'konga murojaat qiling. Mahsulot va qismlar bu yerda ko'rsatilgandan boshqacha ko'rinishda bo'lishi mumkinligini unutmang.



CD(yo'riqnom) /
Karta



Quvvat Kabeli

(Mamlakatlarga qarab)



AC-DC Adapteri

yoki



AC-DC Adapteri
(Mamlakatlarga qarab)

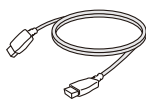

HDMI kabeli

29WK500



Tayanch ustuni

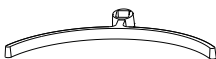

Tayanch asos



Vint qalpog'i



2 dona vint

34WK500

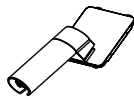

Tayanch ustuni

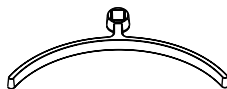

Tayanch asos



EHTIYOT BO'LING

- Mahsulot ish faoliyatini xavfsizligini ta'minlash uchun tasdiqlanmagan qismlardan va aksessuarlardan foydalanmang.
- Mahsulot tasdiqlanmagan qismlarni va aksessuarlarni foydalanish oqibatida zarar yoki shikast, kafolat bilan qamramaydi.
- Taqdim qilingan komponentlardan foydalanish tavsiya qilinadi.
- Agar siz LG tomonidan tasdiqlanmagan umumiy kabellardan foydalansangiz, ekran ko'rsatmasligi yoki tasvirlarda xalaqitlar mavjud bo'lishi mumkin.



ESLATMA

- Qismlari bu erda ko'rsatilgandan boshqacha ko'rinishda bo'lishi mumkin.
- Oldindan ogohlantirmasdan, ushbu qo'llanmada, barcha ma'lumot va xususiyatlari mahsulot ish faoliyatini yaxshilash uchun o'zgarishi mumkin.
- Qo'shimcha aksessuarlarni sotib olish uchun, elektronika do'konlariga yoki onlayn xarid qilish sahifasiga tashrif buyuring yoki mahsulot sotib olgan chakana do'konga murojaat qiling.

Qo'llab-quvvatlanadigan drayverlar va dasturiy ta'minot

So'nggi versiyasini LGE veb-saytidan (www.lg.com) yuklab olishingiz va o'rnatishingiz mumkin.

Drayverlar va dasturiy ta'minot	O'rnatish ustuvorligi	29WK500/34WK500
Monitor drayveri	Tavsiya etiladi	0
OnScreen Control	Tavsiya etiladi	0
Dual Controller	Ixtiyoriy	0

Komponent va Tugma Ta'rifi

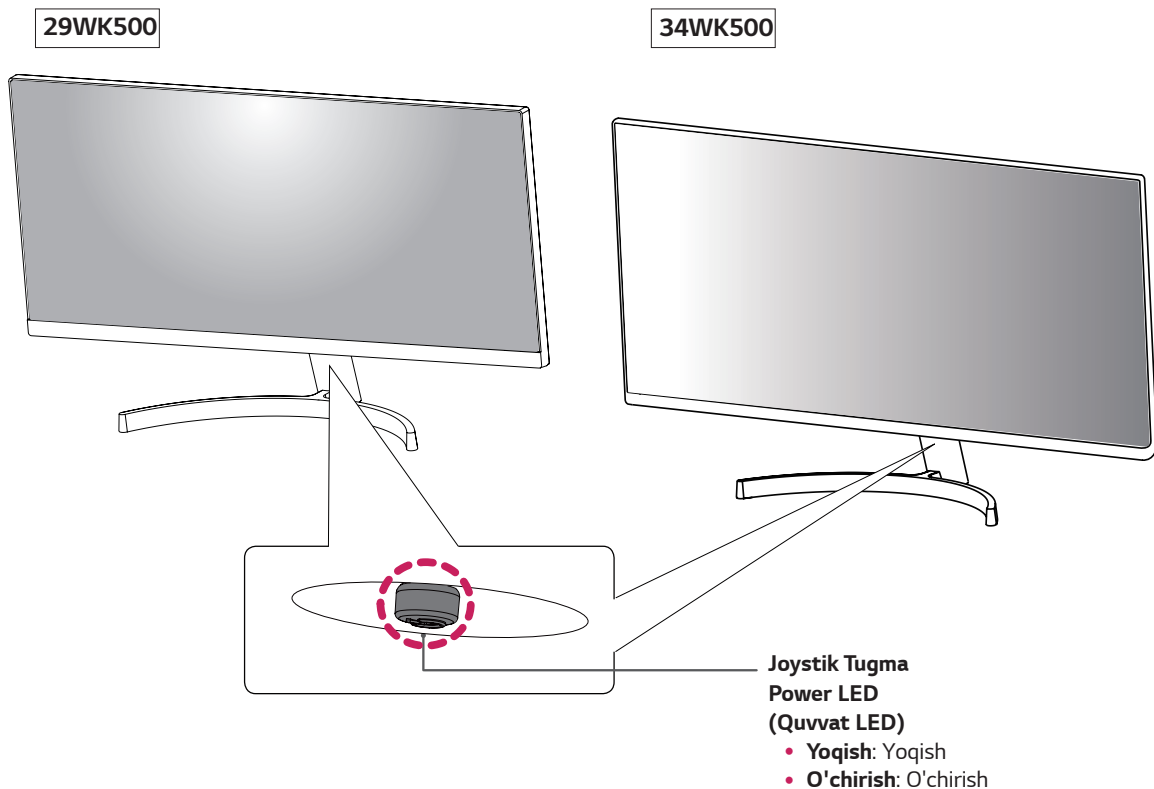

Joystik tugmasidan foydalanish

Siz monitorning funksiyalaridan joystik tugmasini bosib yoki barmoqlaringiz bilan o'ngga/chapga yo'naltirish yordamida osongina boshqarishingiz mumkin.

Asosiy parametrlar

		Yoqish	Monitorni yoqish uchun barmog'ingiz bilan joystikni bir marta bos-ing.
		O'chirish	Monitorni o'chirish uchun barmog'ingiz bilan joystikni bosib, ushlab turing.
		Ovoz balandligi Boshqaruv	Joystikni o'ngga/chapga yo'naltirish yordamida ovoz balandligini boshqarishingiz mumkin.

! ESLATMA

- Joystik Tugma monitorning pastki qismida joylashgan.

Kirish Ulagichi

29WK500

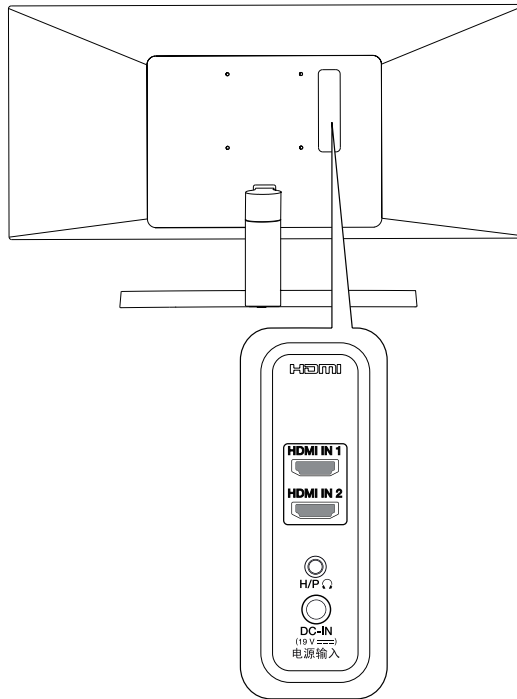

34WK500

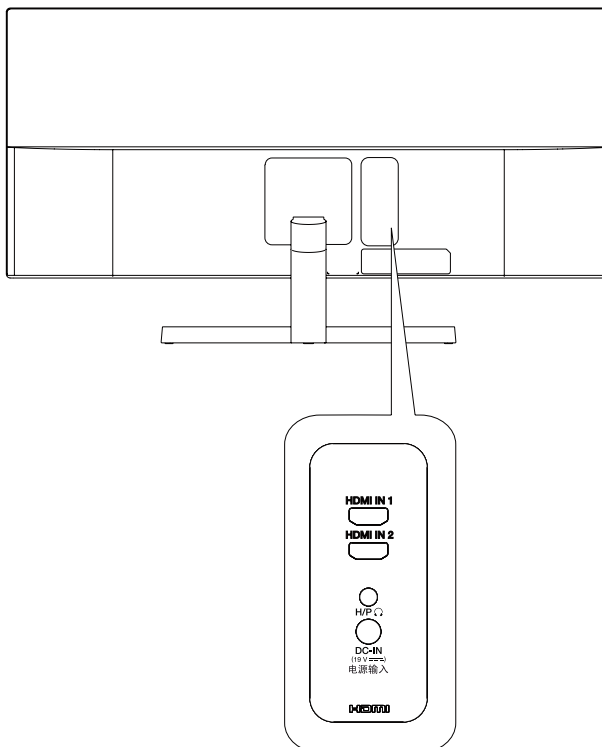

Monitorni joyidan qo'zg'ash va ko'tarish

Monitorni joyidan qo'zg'ashda yoki ko'targanda, monitorning shikastlanishini yoki putur yetishini oldini olish uchun va ko'chirish paytida uning shakli va hajmiga nisbatan havfsizligini ta'minlash uchun ushbu yoriqnomalarni o'qib chiqing.

- Monitorni ko'chirishdan oldin uni asl qutida yoki upakovka materialda o'rash tavsiya etiladi.
- Monitorni joyidan qo'zg'ash va ko'tarishdan oldin, quvvat simlarini va barcha kabellarni elektr ta'minotidan ajratib oling.
- Monitor ramkasining yoqori va pastki qismlarini mahkam ushlang. Ekraning o'zidan ushlamang.

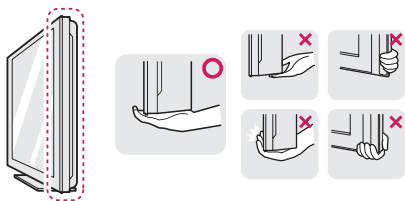

- Monitorni ko'targanda, ekran yuzi shikastlanmasligi uchun siz tomonga qarab turmasligi kerak.



- Monitorni ko'chirganda uning kuch bilan urilishiga yoki vibratsiyalanishiga yo'l qo'ymang.
- Monitorni ko'chirganda, uni vertikal holda ko'taring, monitorni hech qachon yonbosh holda yoqming yoki yonbosh tomonga engashtirmang.

⚠ EHTIYOT BO'LING

- Imkon boricha, monitor ekraniga tegmang. Ushbu holat ekran shikastlanishiga yoki tasvirlar yaratishda qo'llaniladigan piksellarning zararlanishiga olib kelishi mumkin.

29WK500



34WK500

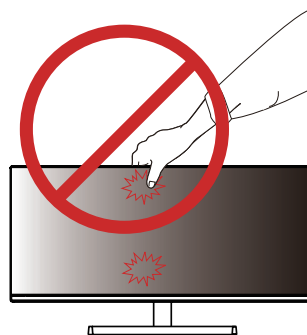

- Agar siz monitor panelini tirgaksiz foydalansangiz, uning joystick tugmasi monitorni yiqilishiga yoki noturg'un holga kelishiga sabab bo'ladi, natijada insonga yoki monitorga jarohat yetishi mumkin, bu esa joystickni shikastlanishiga sabab bo'lishi mumkin.

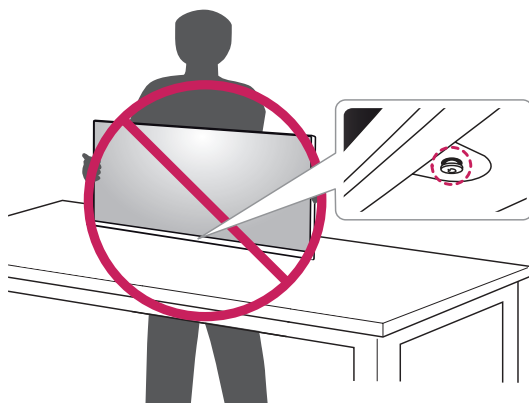

Monitorni o'rnatish

Tirgak asosini montajlash

29WK500

1

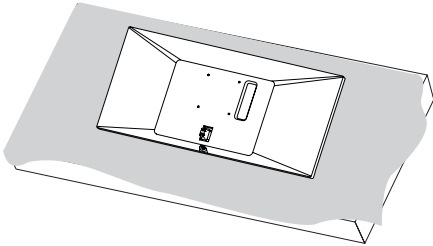

EHTIYOT BO'LING

- Ekranni chiziqlardan himoya qilish uchun, sirtini yumshoq mato bilan qoplang.

2

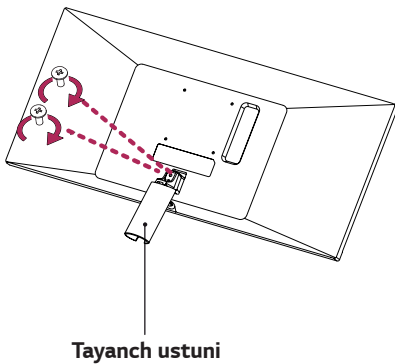

3

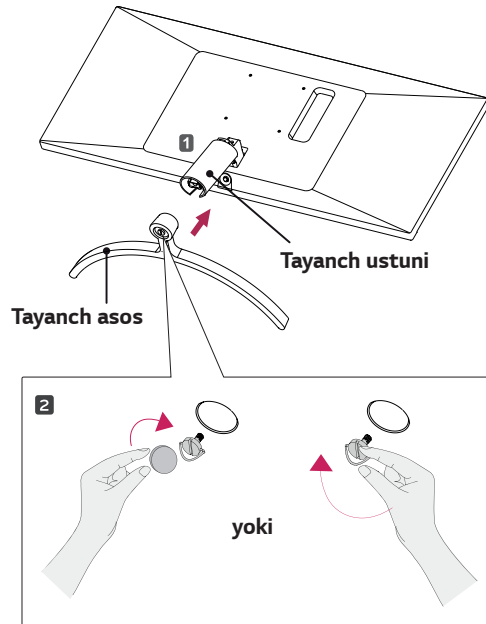

4

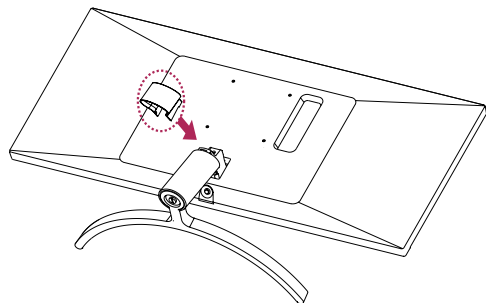

EHTIYOT BO'LING

Vintlarni mustahkamlashda ortiqcha kuch monitorga zarar yetkazishi mumkin. Bu tarzda etkazilgan zarar mahsulot kafolat bilan qoplanmaydi.



EHTIYOT BO'LING

Bu sizning oyog'ingizga jarohat yetkazishi mumkin, shuning uchun ehtiyot bo'ling.



ESLATMA

- Ehtiyot bo'ling, qo'ygichidan tushib ketrsa oyog'ingiz lat yeyishi mumkin.

Monitorni o'rnatish

Tirgak asosini montajlash

34WK500

1

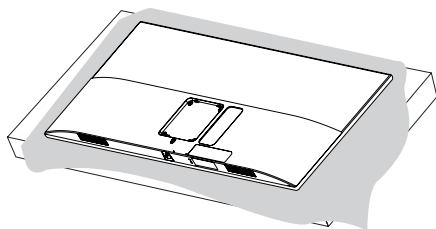

2

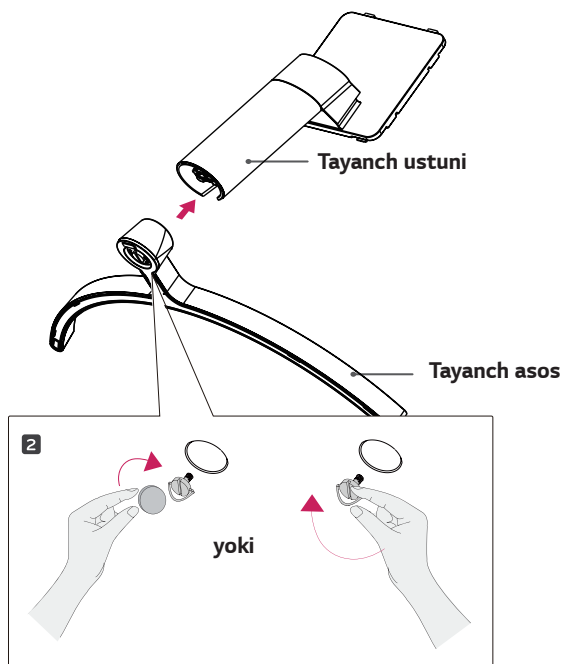

3

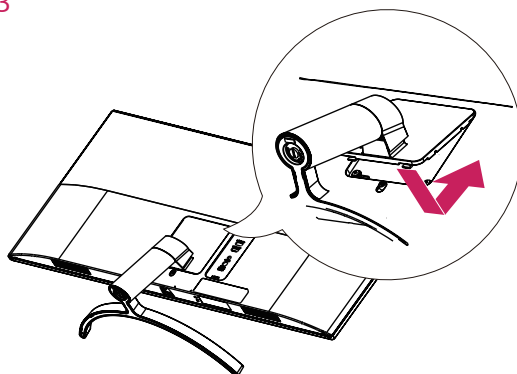

4

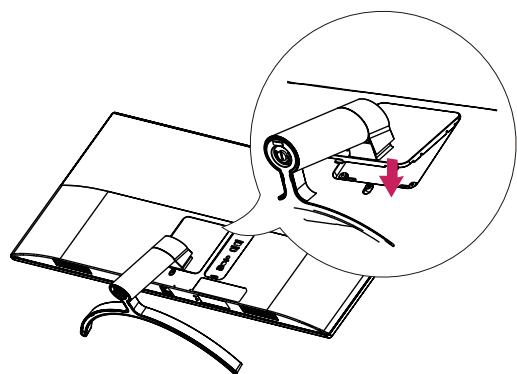

! ESLATMA

- Tugmasi ustiga yetib borgunga qadar tayanchni bosing.

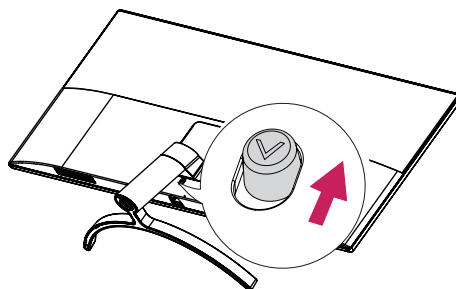



EHTIYOT BO'LING

- Ushbu hujjatda keltirilgan rasmlardagi oddiy jarayonlar,ni ifodalaydi, shuning uchun mahsulot aslidan boshqacha bo'lishi mumkin.
- Xech qachon monitorni teskari qaratib, ya'ni asos taglikdan ushlamang.Buning oqibatida monitor qulab tushadi va zarar yetkazishi mumkin.
- MOnitorni siljitayotganingizda yoki ko'tarayotganingizda,monitor ekraniga qo'lingzni tekkizmang, Bu monitorni shikastlanishiga sabab bo'ladi.
- Mahsulotni yig'ish paytida burama mix qismlariga begona moddalarni (moylar, moylash materiallari, va hokazolar) qo'llamang. (Bunday qilish mahsulotga shikast yetkazishi mumkin.)
- Vintni mahkamlashda ortiqcha kuch qo'llansa, monitorga shikast olib kelishi mumkin. Bu tarzda yetkazilgan zarar mahsulot kafolat tomonidan qoplanib berilmaydi.



ESLATMA

- Ehtiyot bo'ling, qo'ygichidan tushib ketsa oyog'ingiz lat yeyishi mumkin.

Stol ustiga o'rnatish

- 1 Monitorni ko'tarib, stol ustiga o'zingizga mos keladigan joyga joylashtiring.

Yetarli darajada shamollatish uchun devorga kamida 100 mm uzoqlikda joylashtiring.

29WK500

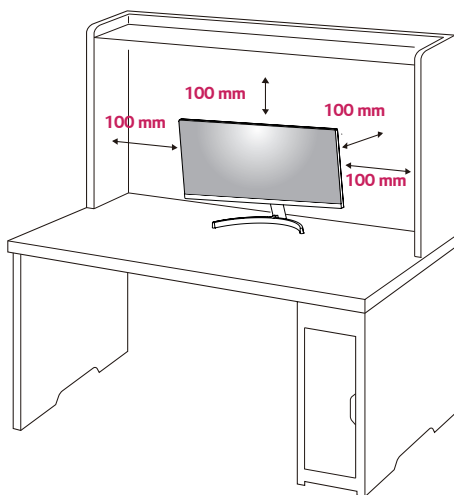

34WK500

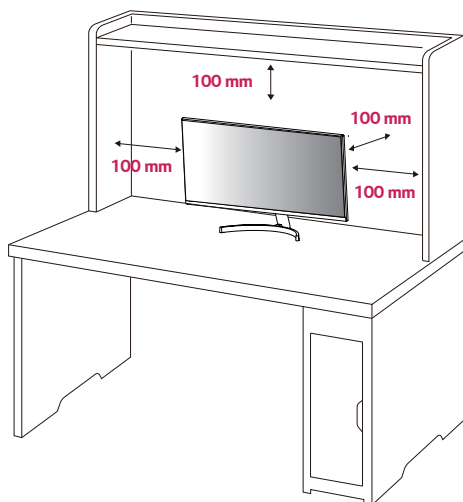

- 2 Elektr shnurini devordagi rozetkaga ulang.

29WK500

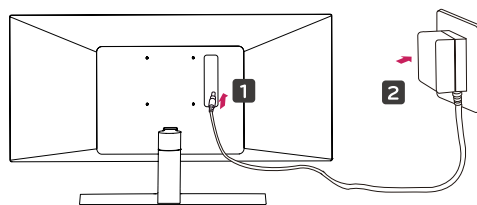

yoki

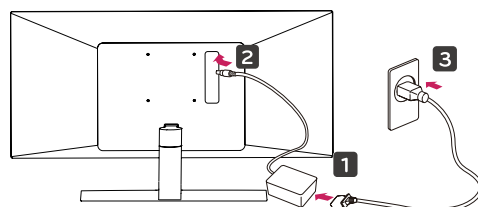

34WK500

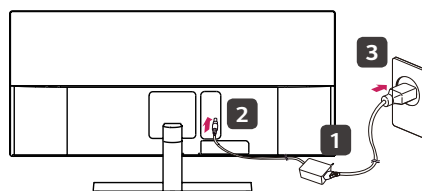

yoki

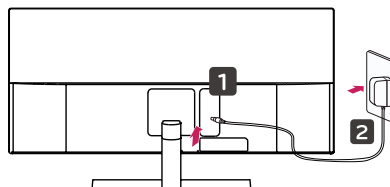

- 3 Monitor ochish uchun monitor tubiga joystick tug-masini bosing.



EHTIYOT BO'LING

- Oldingi harakat yoki monitor yuklamasdan quvvat simini ajratib oling. Elektr tok zarbasining xavfi bor.

Elektr manbaiga ulash shnurini ulashdagi ehtiyot choralari

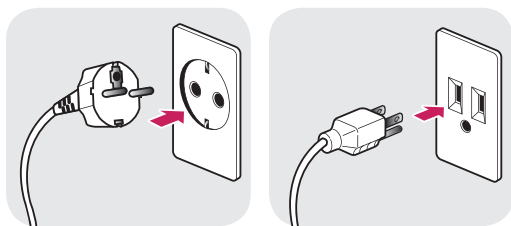

100-240 V ~

- Mahsulot to'plami bilan berilgan elektr manbaiga ulash shnuridan foydalaning va uni yerga ulangan rozetkaga ulang.
- Agar sizga boshqa elektr manbaiga ulash shnuri kerak bo'lsa, mahalliy dilerga yoki sizga yaqin joylashgan chakana savdo do'koniga murojaat qiling.

Burchaklarni sozlash

- 1 Monitorni tik holatda asos taglikka joylashtiring.
- 2 Ekran burchaklarini sozlang. Ekran burchaklari ko'rishga qulay bo'lishi uchun oldinga va orqaga sozlanadi.

29WK500

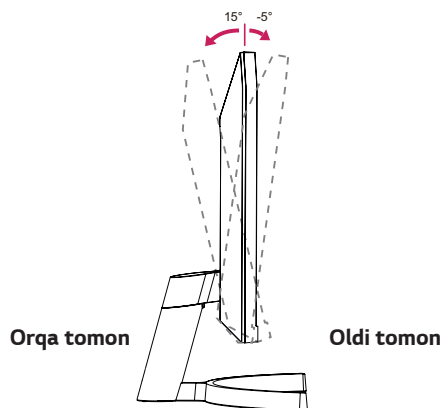

34WK500

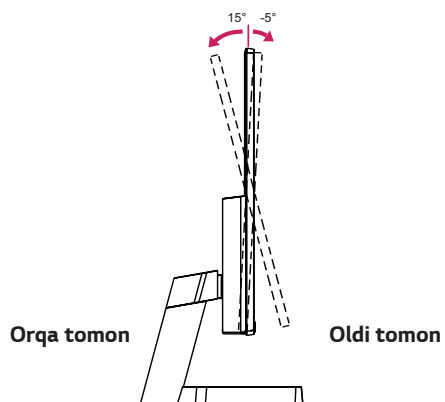



OGOHLANTIRISH

- Ekranni sozlash paytida quyida ko'rsatilgandek, monitorning ramkaning pastki qismini tutmang, barmoqlarni yaralanishini oldini olish uchun.

29WK500

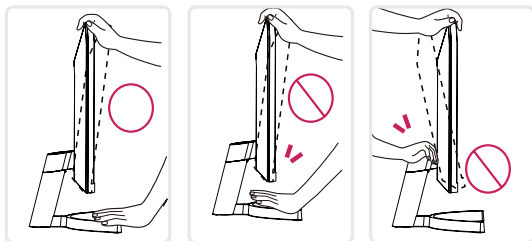

34WK500

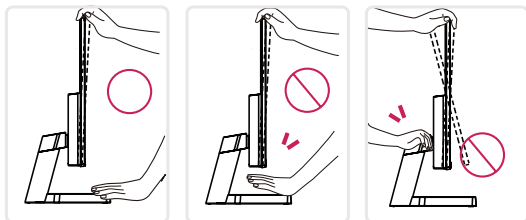

- Monitor burchaklarini sozlashda ekranni yuzasini bosmaslikka va ushlamaslikka harakat qiling.

29WK500

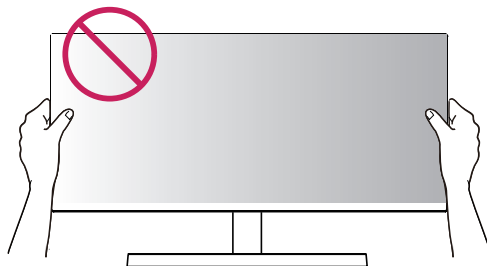

34WK500

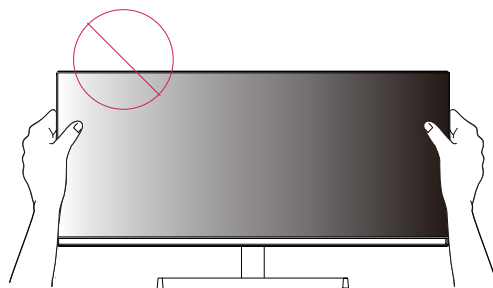

Kensington qulfidan foydalanish

Kensington xavfsizlik tizimi ulagichi monitor to'plamidir orqasida joylashgan.

O'rnatish va foydalanish haqida qo'shimcha ma'lumot olish uchun, Kensington himoyasi foydalanuvchi qo'llanmasiga murojaat qiling yoki <http://www.kensington.com> da saytimizga tashrif buyuring.

Monitor majmui va bir stol o'rtasida Kensington xavfsizlik tizimi kabelini ulang.

29WK500

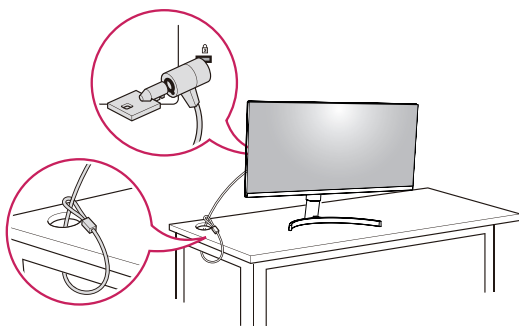

34WK500

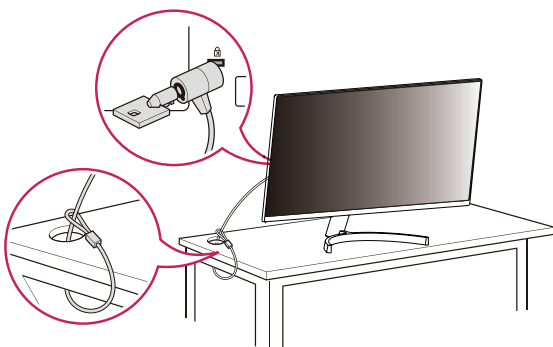

! ESLATMA

- Monitor boshining chap yoki o'ng tomoni bir oz ko'tarish yoki pastga bosish (3° gacha) mumkin. Monitor boshini gorizontol darajasini sozlang.

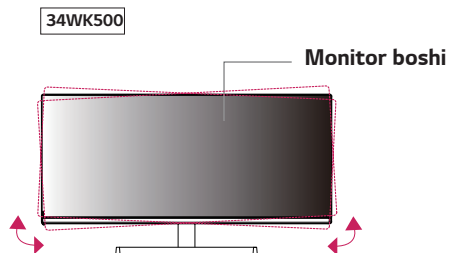

! ESLATMA

- Kensington himoyasi foydalanish ixtiyoriy. Aksessuarlarni mahalliy elektronika do'konida xarid qilish mumkin.

Tayanch korpusini ajratish

34WK500

- 1 Ekran tomonini pastga qaratib joylashtiring. Ekranni tiralishlardan saqlash uchun yuzasini yumshoq mato bilan o'rab qo'ying.
- 2 Monitorning orqa tomoning quyi markazidagi tugmani bosish orqali tayanchni monitordan bo'shatib oling.

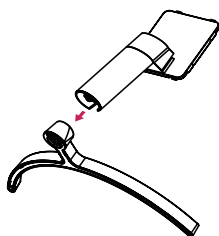
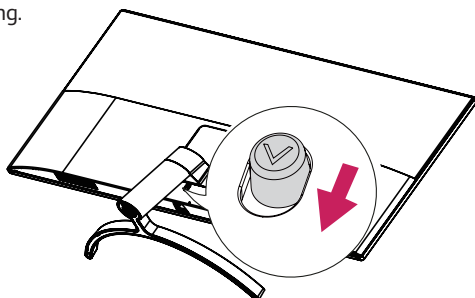

Devorga mahkamlash uchun plastinani o'rnatish

Bu monitor standart devor spetsifikatsiyasi plastinka yoki mos keluvchi qurilmani ulashni qo'llab-quvvatlaydi.

- 1 Ekran yuzini yerga qaratib joylashtiring. Ekrani shiramlardan himoyalash uchun uning yuzini yumshoq mato bilan o'rang.
- 2 Devor plastinasini ham monitor ustiga joylashtiring va vint teshiklariga yotqizing.
- 3 4 ta vintni otyortka yordamida monitorga mahkamlang.

ESLATMA

- Devor plastinasi alohida sotiladi.
- O'rnatish haqida qo'shimcha ma'lumot olish uchun, devorga plastinka o'rnatish qo'llanmasiga qarang.
- Devor plastinasini sozlashda ortiqcha kuch ishlatishdan ehtiyot bo'ling, bu monitor ekranini shikastlanishiga olib kelishi mumkin..

Devorga o'rnatish

Devordan kamida 100 mm uzoqlikda monitor o'rnatish va yetarli shamollatish uchun monitorning har tarafidan bo'sh joy taxminan 100 mm qoldiring. Batafsil o'rnatish ko'rsatmalar mahalliy chakana do'konidan olinishi mumkin. O'rnatish va qiya devor o'rnatish tirsak sozlash qo'llanmasiga murojaat qiling.

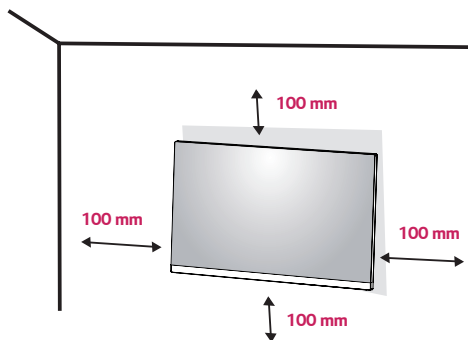

Devorga monitor o'rnatish uchun, monitor orqasiga devorga o'rnatish braketi (ixtiyoriy) mahkamlansin. Devorga o'rnatish braketi monitor va devorni xavfsiz mahkamlab turishiga ishonch hosil qiling.

- 1 Agar siz standartga muvofiq bo'lmagan vintlarni ishlatasangiz, monitor ichki tomondan zararlanishi mumkin.
- 2 Agar siz noto'g'ri vintni ishlatasangiz, monitor zararlanishi mumkin va o'rnatilgan joydan tushib ketishi mumkin. Ushbu vaziyatda, LG Electronics mahsulot kafolatini qoplaymaydi.

29WK500

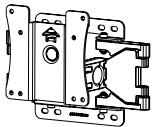
Devorga o'rnatish (A x B)	100 x 100
Standart vint	M4 x L10
Vintlar soni	4
Devorga o'rnatish plastinasi (ixtiyoriy)	LSW 149 

34WK500

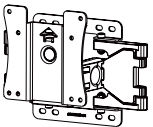
Devorga o'rnatish (A x B)	100 x 100
Standart vint	M4 x L10
Vintlar soni	4
Devorga o'rnatish plastinasi (ixtiyoriy)	LSW 149 

- Devorga o'rnatish (A x B)

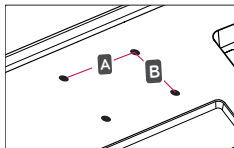

EHTIYOT BO'LING

- Elektr halokati oldini olish uchun monitor o'rnatishdan oldin elektr simini ajratib oling.
- Shipga yoki egilgan devorga monitor o'rnatish pastga tushib ketib, jarohat olib kelishi mumkin. Haqiqiy LG devor o'rnatish braketidan foydalaning. Qo'shimcha ma'lumot olish uchun, iltimos, mahalliy chakana do'kon yoki malakali o'rnatuvchiga murojaat qiling.
- Vintni mahkamlashda ortiqcha kuch qo'llansa, monitorga shikast olib kelishi mumkin. Bu tarzda yetkazilgan zarar mahsulot kafolat tomonidan qoplanib berilmaydi.
- VESA standartidagi muvofiq devor o'rnatishda tirsak va vintlardek foydalaning. Foydalanishda noto'g'ri qismlariga va noto'g'ri foydalanish oqibatidagi zararni mahsulot kafolati qoplamaydi.
- Orqa Panelning tashqi yuzasidagi vint uzunligi 8 mm bo'lishi kerak.

ESLATMA

- Vesa standartlariga muvofiq vintlardan foydalaning.
- Devor plastinasi to'plami o'rnatish yo'riqnomasi va kerakli qismlardan iborat.
- Devor plastinkasi breketlari ixtiyoriy. Ularni max-allaiy do'konlardan ham xarid qilish mumkin.
- Vintlarni uzunligi har bir devor plastinasi breketi uchun turlicha bo'lishi mumkin. Shuning uchun foydalanishdan oldin, kerakli uzunligini tekshiring.
- Qo'shimcha ma'lumotni devor breketi qo'llanmasidan o'qing.

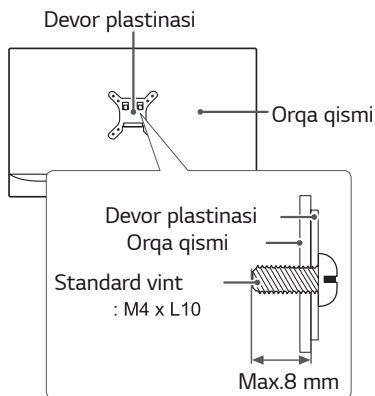

MONITORDAN FOYDALANISH

Shaxsiy kompyuterga ulash

- Bu monitor Plug & Play funkctiyasiga ega.
*Plug & Play: bu xususiyat sizlarga kompyuteringizga xech qanday qo'shimcha drayver o'rnatmasdan yoki qayta sozlamasdan qurilma ulash imkonini beradi.

HDMI ulanish

Raqamli video va audio signallar kompyuterdan va PC va A/V qurilmalardan Monitorga o'tkazib beradi. Quyida tasvirlangan kabi HDMI kabeli bilan monitorni kompyuteringiz va PC va A/V qurilmasiga ulang. Menyu tugmasini bosib va keyin kiritish menyudan kiritish-ni tanlang.

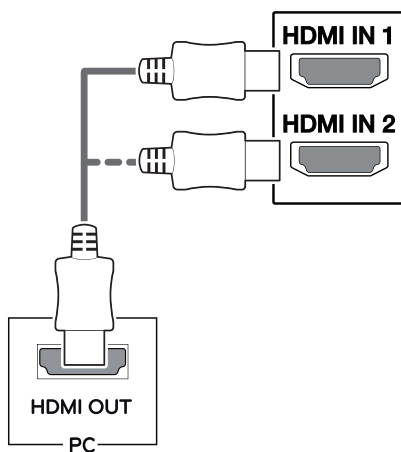

! ESLATMA

- Agar siz shaxsiy kompyuteringizdagi HDMI-ni ishlatsangiz, ushbu vaziyatda mos kelmaslik muammosi kelib chiqishi mumkin.
- HDMI belgisi bilan ta'minlangan sertifikatlangan kabelni ishlating. Agar sertifikatlanmagan HDMI kabelni ishlatsangiz, ekran displeyi ishlamasligi mumkin yoki ulanish xatosi paydo bo'lishi mumkin.
- Tavsiya etilgan kabel turlari:
 - Yuqori tezlikdagi HDMI®/™ kabeli
 - Yuqori tezlikdagi HDMI®/™ kabeli Ethernet tarmog'i bilan

AV qurilmalarga ulash

HDMI ulanish

Raqamli video va audio signallar kompyuterdan va PC va A/V qurilmalardan Monitorga o'tkazib beradi. Quyida tasvirlangan kabi HDMI kabeli bilan monitorni kompyuteringiz va PC va A/V qurilmasiga ulang. Menyu tugmasini bosib va keyin kiritish menyudan kiritish-ni tanlang.

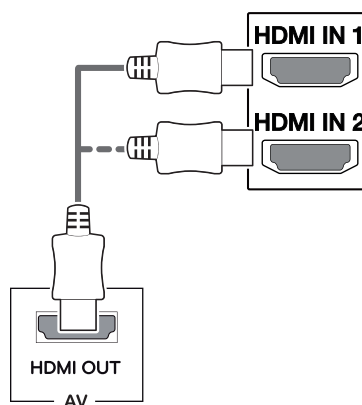

! ESLATMA

- HDMI belgisi bilan ta'minlangan sertifikatlangan kabelni ishlating. Agar sertifikatlanmagan HDMI kabelni ishlatsangiz, ekran displeyi ishlamasligi mumkin yoki ulanish xatosi paydo bo'lishi mumkin.
- Tavsiya etilgan kabel turlari:
 - Yuqori tezlikdagi HDMI®/™ kabeli
 - Yuqori tezlikdagi HDMI®/™ kabeli Ethernet tarmog'i bilan

Tashqi qurilmalar uchun ulanish

Quloqliklarni ulash

Pereferiklarni monitorga quloqliklar orqali ulang. Ularni ko'rsatilgandek ulang.

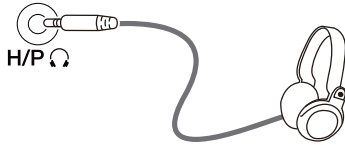

(alohida sotiladi)

! ESLATMA

- Periferik qurilmalar alohida sotiladi.
- Siz ochiladigan naushnik foydalanayotgan bo'lsangiz, u monitorga boshqa tashqi qurilmani ulashda muammo olib kelishi mumkin. Shuning uchun, mos quloqliklardan foydalanish tavsiya etiladi.



egilgan



To'g'ri

- Audio parametrlariga qarab, kompyuter va tashqi qurilma, quloqliklar va dinamik vazifalari cheklangan bo'lishi mumkin.

FOYDALANUVCHI SOZLANMALARI

Asosiy menyuni faollashtirish

- 1 Monitor pastki qismida joylashgan Joystik Tugmani bosing.
- 2 Parametrlarini o'rnatish uchun Joystikni yuqoriga / pastga (▲/▼) va chapga / unga (◀/▶) bosing.
- 3 Asosiy menyuni sahfisini yopish uchun Joystikni bir marta bosing.

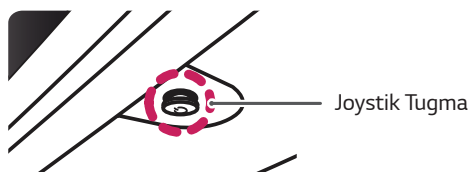

Tugma	Menu holati	Ta'rif
	Asosiy menyuni o'chirilgan	Asosiy menyuni sahfisini o'chiradi.
	Asosiy menyuni yoqilgan	Asosiy menyudan chiqish. (Tugmasini bosing va ushlab turib monitorni o'chiring. Siz bu yo'l bilan har qanday vaqtda monitorni o'chirishingiz mumkin, shuningdek OSD yoqilgan holatda ham)
	◀ Asosiy menyuni o'chirilgan	Monitoring ovoz balandligi darajasini sozlaydi.
	◀ Asosiy menyuni yoqilgan	Input (Kirish) xususiyatiga kiradi.
	▶ Asosiy menyuni o'chirilgan	Monitoring ovoz balandligi darajasini sozlaydi.
	▶ Asosiy menyuni yoqilgan	Settings (Sozlamalar) xususiyatlariga kiradi.
	▲ Asosiy menyuni o'chirilgan	Joriy kiritish bo'yicha ma'lumotlarni namoyish qiladi.
	▲ Asosiy menyuni yoqilgan	Monitorni o'chiradi.
	▼ Asosiy menyuni o'chirilgan	Joriy kiritish bo'yicha ma'lumotlarni namoyish qiladi.
	▼ Asosiy menyuni yoqilgan	Game Mode (O'yin rejimi) xususiyatiga kiradi.

Asosiy menyuni funktsiyalari



Asosiy Menyuni	Ta'rif
Input (Kirish)	Kiritish rejimini o'rnatadi.
Power Off (O'chirish)	Monitorni o'chiradi.
Settings (Sozlamalar)	Ekran sozlamalarini o'rnatadi.
Game Mode (O'yin rejimi)	O'yin uchun o'yin rejimini o'rnatadi.
Exit (Chiqish)	Asosiy menyuni sahfisidan chiqish.

Foydalanuvchi sozlanmalari

Menyu sozlanmalari

- OSD menu (display menyusi)ni ko'rish uchun monitor tagidagi joystick button (joystik tugmasi)ni bosing va so'ng, **Settings (Sozlamalar)** ga kiring.
- Joystikni yuqoriga/pastga/chapga/o'ngga bosib variantlarni belgilang.
- Yuqori menyuga qaytish yoki boshqa menyu elementlarini o'rnatish uchun joystikni ◀ ga o'tkazing yoki (⊙ / Ok)-ni bosing.
- Agar siz OSD menu (display menyusi)dan chiqmoqchi bo'lsangiz, toki chiqib ketmaguncha, joystikni ◀ ga bosing.
 - Menyuga kirganda, ekranining tagidagi o'ng tomonida tugmadan qanday foydalanish mumkinligi haqida yo'riqnomalar paydo bo'ladi.



EHTIYOT BO'LING

- Monitoringizdagi OSD (Ekrandagi display) ushbu qo'llanmada ko'rsatilganidan bir oz farq qilishi mumkin.



Quick Settings



Input



Picture





General

Har bir variant quyida tasvirlanadi.

Settings (Sozlamalar) > Quick Settings (Menyu > Tezkor Sozlamalar)	Ta'rif
Brightness(Ravshanlik)	Ranglar qaramaqa qarshiligi va yorug'ligini sozlang.
Contrast(Kontrast)	
Volume(Ovoz)	Ovozni sozlang. ESLATMA <ul style="list-style-type: none"> Siz Ovoz balandligi menyusida joystik tugmasini ▼ ga yo'naltirib, Mute/ Unmute (Ovozni o'chirish/ Ovozni yoqish)ni sozlashingiz mumkin.

Settings (Sozlamalar) > Input	Ta'rif
Input List	Kirish rejimini tanlaydi.
Aspect Ratio	Ekran tomonlarining nisbatini sozlaydi.
Full Wide	Video signal kiritishidan qat'i nazar, keng-ekranda video ko'rsatadi.
Original (Asl)	Kiruvchi video signaldagi tomonlar nisbatiga mos video ko'rsatadi.
Cinema1 (Kino1)	Ekranni tomonlar nisbati 21:9 gacha kengaytiradi. (1080p)
Cinema2 (Kino2)	Ekranni tomonlar nisbati 21:9 gacha kengaytiradi, shuningdek, subtitrlar tagidagi qora teng burchaklarni ham. (1080p)
	ESLATMA <ul style="list-style-type: none"> Display tavsiya qilingandek o'lchamda ko'rsatishi mumkin. (2560 x 1080). Bu FreeSync (FreeSync) rejimida Cinema1(kinoteatr 1), Cinema2(kinoteatr 2) yo'q, (Picture (Tasvir) → Game Adjust (o'yin moslashtirish) → FreeSync (FreeSync), orqali FreeSync On (FreeSync yoqish) yoki Off (O'chirish)deb sozlang)

Settings (Sozlamalar) > Picture(Rasm)	Ta'rif		
Picture mode (Rasm Rejimi)	Custom	Foydalanuvchiga har bir elementni moslashtirish imkonini beradi. Asosiy menyu rang rejimi sozlanadi.	
	Reader (O'qish)	Ekranni hujjatlarni ko'rish uchun optimal qilib o'zgartiradi. OSD menyusida ekranni yorug'roq qilsangiz bo'ladi.	
	Photo (Fotosurat)	Ekranni sur'at uchun optimal qiladi.	
	Cinema (Kino)	Ekranni video uchun optimal qiladi.	
	Color Weakness	Bu usul qizil rang bilan yashil rangni ajrataolmaydigan foydalanuvchilarga mo'ljallangan. Bu usul rang ajrataolmaydigan foydalanuvchilarga yuqoridagi ikkita rangni bir-biridan oson ajratish imkonini beradi.	
	FPS Game 1	Bu usul FPS o'yinlari uchun optimal qilingan.	
	FPS Game 2	Bunda FPS Game 1 (FPS 1 o'yin) ko'ra Qora rangni muvofiqlashtirish ko'rsatgichlari ko'proq. Bu juda qorong'u FPS o'yinlariga mos keladi.	
	RTS Game	Bu usul RTS Game (RTS O'yin)ga mos keladigan qilib optimallashtirilgan.	
	Custom (Game)	Bu usulda foydalanuvchi turli elementlarni, shuningdek, o'yinga bog'liq tanlashlarni ham o'zi xohlagandek o'zgartirishi mumkin.	
	 ESLATMA <ul style="list-style-type: none"> Tasvir rejimi o'zgargan bo'lsaekranda mitillash mumkin yoki kompyuter ekranning qarori ta'sir ko'rsatishi mumkin. 		
Picture Adjust (Rasm Rostlash)	Brightness	Ekranning yorqinligini sozlash.	
	Contrast	Ekranning kontrastini sozlash.	
	Sharpness (Aniqlik Kiritish)	Ekran o'tkirligini sozlang	
	SUPER RESOLUTION+	High (Yuqori)	Foydalanuvchi tasvir billurdek tiniq bo'lishini xohlaganda tasvir sifatini optimal qilib ko'rsatadi. Bu usul video yoki o'yin sifati high (Yuqori) bo'lganda ishlaydi.
		Middle (O'rtacha)	Ko'rish qulay bo'lishi uchun foydalanuvchi tasvir ko'rinishi low (Past) bilan high (Yuqori) o'rtasida bo'lishini xohlaganda tasvir sifatini optimal qilib ko'rsatadi. Bu usul UCC yoki SD videoda ishlaydi.
		Low (Past)	Foydalanuvchi tasvir tekis va tabiiy bo'lishini xohlaganda tasvir sifatini optimal qilib ko'rsatadi. Bu usul sekin harakatlanadigan yoki qimir-lamaydigan ko'rinishga ishlatiladi.
		Off (O'chirish rejimi)	Bu usulni har kungi ko'rishga ishlatasiz. Bu usulda SUPER RESOLUTION+ (O'TA DONADORLIK+) o'chirilgan bo'ladi.
	 ESLATMA <ul style="list-style-type: none"> Bu past-sonli qarori rasmlar aniq oshirish uchun bir funktsiya bo'ladi, bu normal matn yoki ish stoli ifodalaydi uchun vazifasini foydalanish tavsiya etilmaydi. Shunday qilib, zaruratsiz yuqori aniqlik olib kelishi mumkin. 		
	Black Level (Qora Rang Darajasi)	Siljish darajasini o'rnatish uchun (faqat HDMI kiritish uchun)	
		<ul style="list-style-type: none"> Siljish: video signal uchun ma'lumot sifatida, bu monitor tasvirlay oladigan eng to'q rang hisoblanadi. 	
High (Yuqori)		Ekraning hozirgi keskinlik darajasini saqlab turadi.	
DFC	Low (Past)	Ekandagi joriy kontrast nisbatining qora darajalarni kamaytiradi va oq darajalarni ko'paytiradi.	
	On (Yoqilgan)	Ekranga ko'ra ravshanlikni avtomatik ravishda sozlaydi.	
	Off (O'chirilgan)	DFC xususiyatini o'chiradi.	

Game Adjust	Response Time (Javob Vaqti)	Ekran tezligiga asoslanib ko'rsatilayotgan tasvirlar uchun javob berish vaqtini o'rnatadi. Odatdagi muhit uchun Fast (Tez) dan foydalanish tavsiya etiladi. Tez harakatlanuvchi tasvir uchun Faster (Tezroq) variantidan foydalanish tavsiya etiladi. Faster (Tezroq) ga o'rnatish qoldiq tasvir holatiga sabab bo'lishi mumkin.	
		Faster (Tezroq)	Javob berish vaqtini Faster (Tezroq) holatiga o'rnatadi.
		Fast (Tez)	Javob berish vaqtini Fast (Tez) holatiga o'rnatadi.
		Normal (Odatdagi)	Javob berish vaqtini Normal (Odatdagi) holatiga o'rnatadi.
		Off (O'chirilgan)	Javob berish vaqti yaxshilash xususiyatidan foydalanilmaydi.
FreeSync	Kelayotgan tik signal qaytarilishini chiqayotgan signalniki bilan sinxronlashtirib tasvirni yaxlit va tabiiy qiladi.		
	 EHTIYOT BO'LING <ul style="list-style-type: none"> Mos keladigan interfeys: HDMI. Mos keladigan Video karta: AMDning FreeSync video kartasi kerak bo'ladi. Mos keladigan turi: Video kartani oxirgi ishlatgich dasturga mos qilib yangilab oling. Boshqa ma'lumot bilan talablar http://www.amd.com/FreeSync manzilidagi AMD web sahifasida berilgan. 		
	On (Yoqilgan)	FreeSync funksiyasi yoqilgan.	
	Off (O'chirish)	FreeSync funksiyasi o'chirilgan.	
Black Stabilizer (Qora Stabilizator)	Siz qorong'i sahnada yaxshi ko'rinishga ega bo'lishi uchun qora kontrastini nazorat qilishingiz mumkin. Black Stabilizer(Qora Stabilizator) ekranda past kul rang darajasi yoritadi. (Siz osonlik bilan oyindagi qorong'u joylarda moslamalarni ajrata olasiz.) Black Stabilizer(Qora Stabilizator) qiymatini kamaytirish past kul rang darajasi maydoni qorayib va ekranda dinamik kontrastini oshiradi.		
	Cross Hair	Crosshair First Person Shooter (FPS) o'yinlari uchun ekran markaziga bir belgi beradi. Foydalanuvchilar to'rt xil cross hair (Plus belgi) belgisidan o'z o'yin muhitiga mos cross hair (Plus belgi) ni tanlashi mumkin. <ul style="list-style-type: none"> Ekran o'chirilganda yoki energiya tejash rejimi holatida bo'lganda, cross hair (Plus belgi) xususiyati avtomatik ravishda O'chadi. 	
Color Adjust (Rang Sozlang)	Gamma (Gamma)	Mode 1, Mode 2, Mode 3	Gamma qiymati qanchalik baland bo'lsa, tasvir shunchalik qoraroq bo'ladi. Shu kabi gamma qiymati qanchalik past bo'lsa, tasvir shunchalik yorug'roq bo'ladi.
		Mode 4	Agar gamma sozlashi o'zgartirish kerak bo'lmasa, Mode 4-ni tanlang.
	Color Temp (Rang harorati)	Custom (Urf-odat)	Foydalanuvchi o'ziga mos qilib uni qizil, yashil yoki ko'kka o'zgartirib qo'yishi mumkin.
		Warm (Iliq)	Ekran rangini qizg'ish tusga sozlaydi.
		Medium (O'rta)	Ekran rangini qizil bilan ko'k o'rtasi tusiga sozlaydi.
		Cool (Salqin)	Ekran rangini ko'kimgitir tusga sozlaydi.
	Red (Qizil)	Siz tasvir rangini Red (Qizil) , Green (Yashil) va Blue (Ko'k) ranglardan foydalanib o'rnatishingiz mumkin.	
	Green (Yashil)		
	Blue (Ko'k)		
	Six Color (Oltita rang)	Oltita rangning (Red, Green, Blue, Cyan, Magenta, Yellow) tusi va to'yinganligini boshqarib foydalanuvchining ranglar bo'yicha talablariga javob beradi va so'ng, sozlanmalarni saqlaydi.	
Hue (Tus)		Ekran ranglarining tusini sozlaydi.	
Saturation (To'yinganlik)		Ekran ranglarining to'yinganligini sozlaydi. Qiymati qanchalik kam bo'lsa, ranglar shunchalik kam to'yingan va yorug'roq bo'ladi. Qiymati qanchalik yuqori bo'lsa, ranglar shunchalik ko'p to'yingan va to'qroq bo'ladi.	
Picture Reset	Do you want to Picture reset your settings?		
	No	Cancel	
	Yes	Reset	

Settings (Sozlamalar) > General (Umumiy)	Ta'rif	
Language (Til)	Ekran menyusini istagan tilga o'rnatadi.	
SMART ENERGY SAVING (AQILLI ENERGIYA TEJASH)	High (Yuqori)	Samaradorligi yuqori bo'lgan SMART ENERGY SAVING funksiyasi yordamida quvvatni saqlaydi.
	Low (Past)	Samaradorligi past bo'lgan SMART ENERGY SAVING funksiyasi yordamida quvvatni saqlaydi.
	Off (O'chirish)	SMART ENERGY SAVING funksiyasini o'chiradi.
Power LED (Quvvat LED)	Monitor oldidagi ta'minot indikatorini yoqadi yoki.	
	On (Yoqilgan)	Ta'minot indikatorini yoqiladi.
	Off (O'chirish)	Ta'minot indikatorini o'chiriladi.
Automatic Standby (Avtomatik Kutish)	Ma'lum vaqtgacha ekranda harakat bo'lmasa monitorni o'zi o'chiradigan xususiyat. Taymerni o'zi o'chiradigan xususiyatga o'tkazib qo'yishingiz mumkin. (4 soatda, 6 soatda va 8 soatda ochiradi)	
Buzzer (Zummer)	Bu xususiyat monitor On (Yoqish) -ga o'rnatilganda Zummerdan hosil qilinadigan tovushni o'rnatishingizga imkon beradi.	
	On (Yoqilgan)	Monitoring Buzzer (Zummer) -ini yoqadi.
	Off (O'chirilgan)	Monitoring Buzzer (Zummer) -ini o'chiradi.
OSD Lock (OSD Qulf)	Bu xususiyati menyuni ko'rinishi bilan uni o'zgartirish imkoniyatini o'chiradi.	
	On (Yoqilgan)	Ekran menyusini berkitadi.
	Off (O'chirish)	Ekran menyusini chiqaradi.
	 ESLATMA <ul style="list-style-type: none"> Brightness (Ravshanlik), Contrast (Kontrast), Volume (Ovoz), Input (Kiritishi), OSD Lock (OSD Qulf), Information (Ma'lumot) dan tashqari barcha funksiyalar o'chirib qo'yilgan. 	
Information (Ma'lumot)	Ekranda haqida Model (Model), Serial Number (Seriya raqami), Total Power On Time (Quvvat yoqilgan umumiy vaqti), Resolution (Ravshanligi) haqidagi ma'lumotlar ko'rsatiladi.	
Reset (Qayta tiklash)	Do you want to reset your settings? (Siz sozlanmalarni qayta o'rnatmoqchimisiz?)	
	No	Tanlovni bekor qiling.
	Yes	Dastlab o'rnatilgan sozlanmalarni tiklaydi.

ESLATMA

- Ma'lumotni Saqlash Panelga bog'liq bo'ladi. Shuning uchun bu ko'rsatgichlar har bitta paneldan va panel sotuvchisidan farq qilishi kerak. **SMART ENERGY SAVING High (Yuqori)** yoki **Low (Past)** qiymatini tanlasangiz, monitor yoritgichi manbaga qarab pastroq yoki yuqoriroq bo'ladi.

NOSOZLIKLARNI TUZATISH

Displayda hech narsa ko'rsatilmayapti.

Monitoring elektr manbaiga ulash shnuri ulanganmi?	<ul style="list-style-type: none"> Quvvat manbaiga ulash shnurining rozetkaga to'g'ri ulanganligini tekshiring.
Quvvat LED ko'rsatkichi yoqilganmi?	<ul style="list-style-type: none"> Quvvat manbaiga ulash shnuri ulanishini tekshiring va quvvat tugmasini bosing.
Quvvat yoqilganligi va quvvat LED ko'rsatkichi oq rangda ko'rinayaptimi?	<ul style="list-style-type: none"> Ulangan kirish signali yoqilganligini tekshiring (Settings (Sozlamalar) - Input (Kiritish)).
Quvvat LED ko'rsatkichi miltillayaptimi?	<ul style="list-style-type: none"> Agar monitor elektr energiyani tejash rejimida bo'lsa, displeyni yoqish uchun sichqonchani qimirlating yoki klaviaturada bironta tugmasini bosing. Kompyuter yoqilganligini tekshiring.
" OUT OF RANGE " (DOI-RADAN TASHQARIDA) xabari ko'rsatilmoqdami?	<ul style="list-style-type: none"> Bunday vaziyat kompyuterdan (video kartadan) kelgan signallar monitoring gorizontali yoki vertikal chastotalar doirasidan tashqarida bo'lganda yuzaga keladi. Iltimos, tegishli chastotani belgilash uchun ushbu qo'llanmaning "Product Specification" (Mahsulot xususiyati) bo'limini ko'ring.
" No Signal " (Signal Yo'q) xabari ko'rsatilmoqdami?	<ul style="list-style-type: none"> Bunday xabar kompyuter bilan monitor o'rtasidagi signal kabeli ulanmagan yoki unda signal yo'qligida ko'rsatiladi. Kabelni tekshiring va uni qayta ulang.

"OSD Locked" (Display qulflangan) xabari ko'rsatilmoqda.

Menu (Menyu) tugmasini bosganda ba'zi funksiyalar mavjud emasmi?	<ul style="list-style-type: none"> Display qulflangan. Settings (Sozlamalar) > General (Umumiy) ga o'ting va OSD Lock (OSD Qulfi) ni Off (O'chirish) ga o'rnatib.
--	--

Ekran tasvirni saqlamoqda.

Monitor o'chirilganda tasvir saqlanib qolmoqdami?	<ul style="list-style-type: none"> Harakatsiz tasvirlarni uzoq vaqt davomida aks ettirish tasvirning saqlanishi natijasida ekranning shikastlanishiga olib kelishi mumkin. Monitoring ishlatish muddati davomiyligini cho'zish uchun ekran qo'riqchisidan foydalaning.
---	--

Display ekrani mustahkam emas va tebranib turadi / Monitorida namoyish etilgan tasvirlar soyali izlar qoldirmoqda.

Piksellar sonini to'g'ri tanlaganmi-siz?	<ul style="list-style-type: none"> Agar tanlangan piksellar soni HDMI 1080i 60/50 Hz (tutashgan) bo'lsa, ekran miltillab ishlashi mumkin. Piksellar sonini 1080P yoki talab etilganga o'zgartiring.
--	--



ESLATMA

- Vertical Frequency (Vertikal chastota):** Tasvirni ko'rsatish uchun fluoressent lampa kabi, ekran bir soniyada ko'p marotaba yangilanishi kerak. Bir soniyada ekran yangilanishining soni vertikal chastota yoki yangilash tezligi deb ataladi va Hz (Gers) bilan ifodalanadi.
- Horizontal Frequency (Gorizontali chastota):** Bitta gorizontali chiziqni ko'rsatishga ketgan vaqtni gorizontali davr deb atashadi. Agar 1-ni gorizontali oraliqqa bo'lsak, natijada bir soniyada gorizontali chiziq soni kelib chiqadi. Buni gorizontali chastota deb atashadi va u kHz (Gers) bilan ifodalanadi.

**ESLATMA**

- Video kartaning tiniqligi yoki chastotasi monitorga ruxsat etilgani bilan bir xil ekanini tekshirib ko'ring va Ishlatish Paneli > Display > to'g'rilashda tavsiya qilingan (optimal) tiniqlikka o'tkazib qo'ying.
- Video karta tavsiya etilgan (optimal) tiniqlikka o'tkazilmasa yozuvlar xiralashishi, ekran so'nishi, display yuzasi qisqarishi yoki display og'ib ko'rsatishi mumkin.
- Kompyuter yoki operatsion tizimga qarab to'g'rilash usuli har xil bo'lishi, video kartaning ishlashiga qarab esa ba'zi tiniqlashtirish usullari ishlamasligi mumkin. Shunday bo'lganda kompyuter ishlab chiqaruvchi yoki video karta ishlab chiqaruvchi bilan bog'lanib yordam so'rang.
- Ba'zi video kartalar 2560 × 1080 tiniqlikni ko'tarmasligi mumkin. Agar tiniqlik chiqarilmasa video karta ishlab chiqaruvchi bilan bog'laning.

Display rangi buzilgan.	
Namoyish rangsizdek ko'rinmoqdami (16 rang)?	<ul style="list-style-type: none"> • Rangni 24 bit (true color) yoki undan yuqorisiga o'rnatning. Windows-da, Control Panel > Display > Settings > Color Quality (Boshqaruv paneli > Display > Sozlanmalar > Rang sifati)ga o'ting.
Display rangi mustahkam emas va oq-qora rangda ko'rsatilmoqdami?	<ul style="list-style-type: none"> • Signal kabeli to'g'ri ulanganligini tekshiring. Kabelni qayta ulang yoki kompyuterdagi videokartani qayta o'rnatib ko'ring.
Ekranida dog'lar mavjudmi?	<ul style="list-style-type: none"> • Monitoridan foydalanganda (qizil, yashil, ko'k, oq yoki qora) nuqtali dog'lar paydo bo'lishi mumkin. LCD (Suyuq Kristalli Display) ekrani uchun bu oddiy holdir. Bu xato ham emas, monitorning ishlashiga ham tegishli emasdir.

Siz «Tan olinmagan monitor, Plug and Play (VESA DDC) monitor aniqlandi» kabi habarni ko'riyabsizmi?

Display drayverini o'rnatdingizmi?	<ul style="list-style-type: none"> • Display drayverini veb-saytimizdan albatta o'rnatib oling: http://www.lg.com. • Videokarta Plug and Play funksiyasiga to'g'ri kelishiga ishonch hosil qiling.
------------------------------------	--

Quloqqa taqqich porti yoki ovoz chiqargichdan ovoz chiqmayapti.

DisplayPort yoki HDM ulagich ishlatilganda tasvir ko'rinib, ovoz eshitilmayaptimi?	<ul style="list-style-type: none"> • Monitoridagi tugmani ishlatib ovozni ko'tarishga harakat qilib ko'ring. • Kompyuter ovoz chiqishini ishlatilayotgan monitorga o'tkazib qo'ying. Microsoft Windows da Ishlatish Paneli > Qismlar va Ovoz > Ovoz > ga o'ting va birlamchi ovoz chiqishini monitorga o'tkazib qo'ying.
--	---

XUSUSIYATLAR

29WK500

LCD Ekran	Tur	TFT (Nozik kino tranzistor) LCD (Suyuq Kristalli Display) ekran
	Piksel qadami	0,2628 mm x 0,2628 mm
Piksellar soni	Maksimum o'lcham	2560 x 1080 @ 75 Hz
	Tavsiya qilingan o'lcham	2560 x 1080 @ 60 Hz
Video Signal	Gorizontaal chastota	30 kHz dan 90 kHz-gacha
	Vertikal chastota	56 Hz dan 75 Hz-gacha
Kirish ulagichi	HDMI IN1, HDMI IN2, H/P	
Kuchlanish	19 V --- 1,6 A Yoki 19 V --- 1,3 A	
Quvvat iste'moli (Typ.)	Rejimda: 25 W Typ. (Chiqishdagi sharti) * Uyqu rejimi ≤ 0,5 W ** O'chgan rejim ≤ 0,3 W	
AC/DC Adapteri	Turi ADS-40SG-19-3 19032G, SHENZHEN HONOR ELECTRONIC mahsuloti Yoki turi ADS-40FSG-19 19032GPG-1, SHENZHEN HONOR ELECTRONIC mahsuloti Yoki turi ADS-40FSG-19 19032GPBR-1, SHENZHEN HONOR ELECTRONIC mahsuloti Yoki turi ADS-40FSG-19 19032GPI-1, SHENZHEN HONOR ELECTRONIC mahsuloti Yoki turi ADS-40FSG-19 19032GPCU-1, SHENZHEN HONOR ELECTRONIC mahsuloti Yoki turi ADS-32FSG-19 19032EPCU-1L, SHENZHEN HONOR ELECTRONIC mahsuloti Yoki turi LCAP21A, LIEN CHANG ELECTRONIC ENTERPRISE mahsuloti Yoki turi LCAP26A-A, LIEN CHANG ELECTRONIC ENTERPRISE mahsuloti Yoki turi LCAP26A-E, LIEN CHANG ELECTRONIC ENTERPRISE mahsuloti Yoki turi LCAP26A-I, LIEN CHANG ELECTRONIC ENTERPRISE mahsuloti Yoki turi LCAP26A-B, LIEN CHANG ELECTRONIC ENTERPRISE mahsuloti Yoki turi LCAP51A, LIEN CHANG ELECTRONIC ENTERPRISE mahsuloti Yoki turi PA-1031-23, Lite-On Technology Corporation mahsuloti chiqish: 19 V --- 1,7 A	
	Turi ADS-40SG-19-3 19025G, SHENZHEN HONOR ELECTRONIC mahsuloti Yoki turi ADS-40FSG-19 19025GPG-1, SHENZHEN HONOR ELECTRONIC mahsuloti Yoki turi ADS-40FSG-19 19025GPBR-1, SHENZHEN HONOR ELECTRONIC mahsuloti Yoki turi ADS-40FSG-19 19025GPI-1, SHENZHEN HONOR ELECTRONIC mahsuloti Yoki turi ADS-40FSG-19 19025GPCU-1, SHENZHEN HONOR ELECTRONIC mahsuloti Yoki turi ADS-40FSG-19 19025GPB-2, SHENZHEN HONOR ELECTRONIC mahsuloti Yoki turi ADS-25FSG-19 19025EPCU-1L, SHENZHEN HONOR ELECTRONIC mahsuloti Yoki turi LCAP21, LIEN CHANG ELECTRONIC ENTERPRISE mahsuloti Yoki turi LCAP26-A, LIEN CHANG ELECTRONIC ENTERPRISE mahsuloti Yoki turi LCAP26-E, LIEN CHANG ELECTRONIC ENTERPRISE mahsuloti Yoki turi LCAP26-I, LIEN CHANG ELECTRONIC ENTERPRISE mahsuloti Yoki turi LCAP26-B, LIEN CHANG ELECTRONIC ENTERPRISE mahsuloti Yoki turi LCAP51, LIEN CHANG ELECTRONIC ENTERPRISE mahsuloti Yoki turi WA-24C19FS, Asian Power Devices Inc. mahsuloti Yoki turi WA-24C19FN, Asian Power Devices Inc. mahsuloti Yoki turi DA-24B19, Asian Power Devices Inc. mahsuloti chiqish: 19 V --- 1,3 A	

Ekologik holati	Foydalanish holati	Harorat: 0°C dan 40°C gacha ; namlik: < 80%
	Saqlash holati	Harorat: -20°C dan 60°C gacha ; namlik: < 85%
O'lchov	Monitor o'lchami (Eniga x Bo'lyiga x chuqurligi)	
	Ustun bilan(Stend)	698,1 mm x 410,9 mm x 209,4 mm
	Tayanchsiz	698,1 mm x 317,5 mm x 76,9 mm
Og'irligi (Upakovkasiz)	Ustun bilan(Stend)	4,9 kg
	Tayanchsiz	4,4 kg

Xususiyatlari ogohlantirmagan holda o'zgarishi mumkin

Quvvat iste'moli darajasi monitor sozlamalariga va ishlash muhitiga ko'ra farqlanishi mumkin.

* "Ishlayapty" holatida elektr iste'mol qilishi LGE sinash standartlariga muvofiq o'lchanadi (Ko'rinishi to'liq oq, Donadorligi esa oxirida bo'ladi).

** Bir necha daqiqalarda (ko'pi bilan 5 daqiqa) monitor Uyqu rejimiga o'tadi.

XUSUSIYATLAR

34WK500

LCD Ekran	Tur	TFT (Nozik kino tranzistor) LCD (Suyuq Kristalli Display) ekran
	Piksel qadami	0,312 mm x 0,310 mm
Piksellar soni	Maksimum o'lcham	2560 x 1080 @ 75 Hz
	Tavsiya qilingan o'lcham	2560 x 1080 @ 60 Hz
Video Signal	Gorizontal chastota	30 kHz dan 90 kHz-gacha
	Vertikal chastota	56 Hz dan 75 Hz-gacha
Kirish ulagichi	HDMI IN1, HDMI IN2, H/P	
Kuchlanish	19 V --- 2,0 A Yoki 19 V --- 1,6 A	
Quvvat iste'moli (Typ.)	Rejimda: 35 W Typ. (Chiqishdagi sharti) * Uyqu rejimi ≤ 0,5 W ** O'chgan rejim ≤ 0,3 W	
AC/DC Adapteri	Turi ADS-45SN-19-3 19040G, SHENZHEN HONOR ELECTRONIC mahsuloti Yoki turi LCAP21C, LIEN CHANG ELECTRONIC ENTERPRISE mahsuloti Yoki turi LCAP26B-E, LIEN CHANG ELECTRONIC ENTERPRISE mahsuloti Yoki turi LCAP26B-A, LIEN CHANG ELECTRONIC ENTERPRISE mahsuloti chiqish: 19 V --- 2,1 A	
	Turi ADS-40SG-19-3 19032G, SHENZHEN HONOR ELECTRONIC mahsuloti Yoki turi ADS-40FSG-19 19032GPG-1, SHENZHEN HONOR ELECTRONIC mahsuloti Yoki turi ADS-40FSG-19 19032GPBR-1, SHENZHEN HONOR ELECTRONIC mahsuloti Yoki turi ADS-40FSG-19 19032GPI-1, SHENZHEN HONOR ELECTRONIC mahsuloti Yoki turi ADS-40FSG-19 19032GPCU-1, SHENZHEN HONOR ELECTRONIC mahsuloti Yoki turi ADS-32FSG-19 19032EPCU-1L, SHENZHEN HONOR ELECTRONIC mahsuloti Yoki turi LCAP21A, LIEN CHANG ELECTRONIC ENTERPRISE mahsuloti Yoki turi LCAP26A-A, LIEN CHANG ELECTRONIC ENTERPRISE mahsuloti Yoki turi LCAP26A-E, LIEN CHANG ELECTRONIC ENTERPRISE mahsuloti Yoki turi LCAP26A-I, LIEN CHANG ELECTRONIC ENTERPRISE mahsuloti Yoki turi LCAP26A-B, LIEN CHANG ELECTRONIC ENTERPRISE mahsuloti Yoki turi LCAP51A, LIEN CHANG ELECTRONIC ENTERPRISE mahsuloti chiqish: 19 V --- 1,7 A	
Ekologik holati	Foydalanish holati	Harorat: 0°C dan 40°C gacha ; namlik: < 80%
	Saqlash holati	Harorat: -20°C dan 60°C gacha ; namlik: < 85%
O'lchov	Monitor o'lchami (Eniga x Bo'yiga x chuqurligi)	
	Ustun bilan(Stend)	828,5 mm x 460,7 mm x 209,4 mm
	Tayanchsiz	828,5 mm x 370,2 mm x 41,5 mm
Og'irligi (Upakovkasiz)	Ustun bilan(Stend)	6,9 kg
	Tayanchsiz	6,1 kg

Xususiyatlari ogohlantirmagan holda o'zgarishi mumkin

Quvvat iste'moli darajasi monitor sozlamalariga va ishlash muhitiga ko'ra farqlanishi mumkin.

* "Ishlayapty" holatida elektr iste'mol qilishi LGE sinash standartlariga muvofiq o'lchanadi (Ko'rinishi to'liq oq, Donadorligi esa oxirida bo'ladi).

** Bir necha daqiqalarda (ko'pi bilan 5 daqiqa) monitor Uyqu rejimiga o'tadi.

Standart qo'llab-quvvatlash holati (Preset Mode, PC)

HDMI

O'lchamlar(HDMI)	Gorizontal chastota (kHz)	Vertikal chastota (Hz)	Ikki qutblilik (H/V)	Izohlar
720 x 400	31,468	70,08	-/+	
640 x 480	31,469	59,94	-/-	
640 x 480	37,5	75	-/-	
800 x 600	37,879	60,317	+/+	
800 x 600	46,875	75	+/+	
1024 x 768	48,363	60	-/-	
1024 x 768	60,123	75,029	+/+	
1152 x 864	67,5	60	+/+	
1280 x 720	45	60	+/+	
1280 x 1024	63,981	60,02	+/+	
1280 x 1024	79,976	75,025	+/+	
1600 x 900	60	60	+/+	
1680 x 1050	65,29	59,954	-/+	
1920 x 1080	67,5	60	+/-	
1920 x 1080	83,89	74,97	+/-	
2560 x 1080	66,7	60	-/+	
2560 x 1080	83,92	74,99	+/-	

HDMI Sinxronizatsiyasi (Video)

Fabrika dastlabki rejimi (Ilk o'lchamlar rejim)	Gorizontal chastota (kHz)	Vertikal chastota (Hz)	Izohlar
480p	31,5	60	
576P	31,25	50	
720p	37,5	50	
720p	45,0	60	
1080p	56,25	50	
1080p	66,7	60	

Quvvat LED

Rejim	LED Rang
Rejimda	Oq(Bir necha soniya uchun)
Uyqu rejimida	O'chirish
O'chgan rejimida	O'chirish



Ushbu jihoz maishiy texnika uchun (B Daraja) EMC talablariga to'g'ri keladi va uyda ishlatishga mo'ljallangan. Mahsulot modeli va seriya raqami mahsulotning orqa paneli va yon tomonlaridan birida joylashgan. Servis xizmati ko'rsatish zarur bo'ladigan hollar uchun ularni quyidagiga yozib oling.

RUSUMI _____

SERIYASI _____