

INSTALLATION MANUAL

AIR CONDITIONER

Please read this installation manual completely before installing the product.
Installation work must be performed in accordance with the national wiring standards
by authorized personnel only.
Please retain this installation manual for future reference after reading it thoroughly.

MULTI V™ III

ARUN Series



IMPORTANT!

Please read this instruction sheet completely before installing the product.

This air conditioning system meets strict safety and operating standards. As the installer or service person, it is an important part of your job to install or service the system so it operates safely and efficiently.



WARNING

- Installation or repairs made by unqualified persons can result in hazards to you and others. Installation of all field wiring and components **MUST** conform with local building codes or, in the absence of local codes, with the National Electrical Code 70 and the National Building Construction and Safety Code or Canadian Electrical code and National Building Code of Canada.
- The information contained in the manual is intended for use by a qualified service technician familiar with safety procedures and equipped with the proper tools and test instruments.
- Failure to carefully read and follow all instructions in this manual can result in equipment malfunction, property damage, personal injury and/or death.

CAUTION: Improper installation, adjustment, alteration, service or maintenance can void the warranty. The weight of the condensing unit requires caution and proper handling procedures when lifting or moving to avoid personal injury. Use care to avoid contact with sharp or pointed edges.

Safety Precautions

- Always wear safety eye wear and work gloves when installing equipment.
- Never assume electrical power is disconnected. Check with meter and equipment.
- Keep hands out of fan areas when power is connected to equipment.
- R-410A causes frostbite burns.
- R-410A is toxic when burned.

NOTE TO INSTALLING DEALER: The Owners Instructions and Warranty are to be given to the owner or prominently displayed near the indoor Furnace/Air Handler Unit.



Special warnings

When wiring:

Electrical shock can cause severe personal injury or death. Only a qualified, experienced electrician should attempt to wire this system.

- Do not supply power to the unit until all wiring and tubing are completed or reconnected and checked.
- Highly dangerous electrical voltages are used in this system. Carefully refer to the wiring diagram and these instructions when wiring. Improper connections and inadequate grounding can cause accidental injury or death.
- Ground the unit following local electrical codes.
- Connect all wiring tightly. Loose wiring may cause overheating at connection points and a possible fire hazard.
- The choice of materials and installations must comply with the applicable local/national or international standards.

When transporting:

Be careful when picking up and moving the indoor and outdoor units. Get a partner to help, and bend your knees when lifting to reduce strain on your back. Sharp edges or thin aluminum fins on the air conditioner can cut your finger.

When installing...

... **in a wall:** Make sure the wall is strong enough to hold the unit's weight.

It may be necessary to construct a strong wood or metal frame to provide added support.

... **in a room:** Properly insulate any tubing run inside a room to prevent "sweating" that can cause dripping and water damage to wall and floors.

... **in moist or uneven locations:** Use a raised concrete pad or concrete blocks provide a solid, level foundation for the outdoor unit. This prevents water damage and abnormal vibration.

... **in an area with high winds:** Securely anchor the outdoor unit down with bolts and a metal frame. Provide a suitable air baffle.

... **in a snowy area(for Heat Pump Model):** Install the outdoor unit on a raised platform that is higher than drifting snow. Provide snow vents.

When connecting refrigerant tubing

- Keep all tubing runs as short as possible.
- Use the flare method for connecting tubing.
- Check carefully for leaks before starting the test run.

When servicing

- Turn the power OFF at the main power box(mains) before opening the unit to check or repair electrical parts and wiring.
- Keep your fingers and clothing away from any moving parts.
- Clean up the site after you finish, remembering to check that no metal scraps or bits of wiring have been left inside the unit being serviced.

TABLE OF CONTENTS

Safety Precautions	4
Installation Process.....	8
Outdoor units Information	9
Alternative Refrigerant R410A	14
Select the Best Location.....	14
Installation Space	15
Lifting method.....	17
Installation.....	18
Refrigerant piping installation.....	23
Pipe connections between indoor and outdoor unit.....	27
Electrical Wiring	53
Test Run.....	80
New Function	100
Caution For Refrigerant Leak	108
Installation guide at the seaside	110

Safety Precautions



To prevent injury to the user or other people and property damage, the following instructions must be followed.

■ Incorrect operation due to ignoring instruction will cause harm or damage. The seriousness is classified by the following indications.

 **WARNING** This symbol indicates the possibility of death or serious injury.

 **CAUTION** This symbol indicates the possibility of injury or damage to properties only.

■ Meanings of symbols used in this manual are as shown below.

	Be sure not to do.
	Be sure to follow the instruction.

WARNING

Installation

- Have all electric work done by a licensed electrician according to "Electric Facility Engineering Standard" and "Interior Wire Regulations" and the instructions given in this manual and always use a special circuit.
 - If the power source capacity is inadequate or electric work is performed improperly, electric shock or fire may result.
- Ask the dealer or an authorized technician to install the air conditioner.
 - Improper installation by the user may result in water leakage, electric shock, or fire.
- Always ground the product.
 - There is risk of fire or electric shock.
- Always install a dedicated circuit and breaker.
 - Improper wiring or installation may cause fire or electric shock.
- For re-installation of the installed product, always contact a dealer or an Authorized Service Center.
 - There is risk of fire, electric shock, explosion, or injury.
- Do not install, remove, or re-install the unit by yourself (customer).
 - There is risk of fire, electric shock, explosion, or injury.
- Do not store or use flammable gas or combustibles near the air conditioner.
 - There is risk of fire or failure of product.
- Use the correctly rated breaker or fuse.
 - There is risk of fire or electric shock.
- Prepare for strong wind or earthquake and install the unit at the specified place.
 - Improper installation may cause the unit to topple and result in injury.
- Do not install the product on a defective installation stand.
 - It may cause injury, accident, or damage to the product.
- When installing and moving the air conditioner to another site, do not charge it with a different refrigerant from the refrigerant specified on the unit.
 - If a different refrigerant or air is mixed with the original refrigerant, the refrigerant cycle may malfunction and the unit may be damaged.

- Do not reconstruct to change the settings of the protection devices.
 - If the pressure switch, thermal switch, or other protection device is shorted and operated forcibly, or parts other than those specified by LGE are used, fire or explosion may result.
- Ventilate before operating air conditioner when gas leaked out.
 - It may cause explosion, fire, and burn.
- Securely install the cover of control box and the panel.
 - If the cover and panel are not installed securely, dust or water may enter the outdoor unit and fire or electric shock may result.
- If the air conditioner is installed in a small room, measures must be taken to prevent the refrigerant concentration from exceeding the safety limit when the refrigerant leaks.
 - Consult the dealer regarding the appropriate measures to prevent the safety limit from being exceeded. Should the refrigerant leak and cause the safety limit to be exceeded, hazards due to lack of oxygen in the room could result.
- Use a vacuum pump or Inert (nitrogen) gas when doing leakage test or air purge. Do not compress air or Oxygen and Do not use Flammable gases. Otherwise, it may cause fire or explosion.
 - There is the risk of death, injury, fire or explosion.

Operation

- Do not damage or use an unspecified power cord.
 - There is risk of fire, electric shock, explosion, or injury.
- Use a dedicated outlet for this appliance.
 - There is risk of fire or electrical shock.
- Be cautious that water could not enter the product.
 - There is risk of fire, electric shock, or product damage.
- Do not touch the power switch with wet hands.
 - There is risk of fire, electric shock, explosion, or injury.
- When the product is soaked (flooded or submerged), contact an Authorized Service Center.
 - There is risk of fire or electric shock.
- Be cautious not to touch the sharp edges when installing.
 - It may cause injury.
- Take care to ensure that nobody could step on or fall onto the outdoor unit.
 - This could result in personal injury and product damage.
- Do not open the inlet grille of the product during operation. (Do not touch the electrostatic filter, if the unit is so equipped.)
 - There is risk of physical injury, electric shock, or product failure.



CAUTION

Installation

- Always check for gas (refrigerant) leakage after installation or repair of product.
 - Low refrigerant levels may cause failure of product.
- Do not install the product where the noise or hot air from the outdoor unit could damage the neighborhoods.
 - It may cause a problem for your neighbors.
- Keep level even when installing the product.
 - To avoid vibration or water leakage.
- Do not install the unit where combustible gas may leak.
 - If the gas leaks and accumulates around the unit, an explosion may result.
- Use power cables of sufficient current carrying capacity and rating.
 - Cables that are too small may leak, generate heat, and cause a fire.
- Do not use the product for special purposes, such as preserving foods, works of art, etc. It is a consumer air conditioner, not a precision refrigeration system.
 - There is risk of damage or loss of property.
- Keep the unit away from children. The heat exchanger is very sharp.
 - It can cause the injury, such as cutting the finger. Also the damaged fin may result in degradation of capacity.
- When installing the unit in a hospital, communication station, or similar place, provide sufficient protection against noise.
 - The inverter equipment, private power generator, high-frequency medical equipment, or radio communication equipment may cause the air conditioner to operate erroneously, or fail to operate. On the other hand, the air conditioner may affect such equipment by creating noise that disturbs medical treatment or image broadcasting.
- Do not install the product where it is exposed to sea wind (salt spray) directly.
 - It may cause corrosion on the product. Corrosion, particularly on the condenser and evaporator fins, could cause product malfunction or inefficient operation.

Operation

- Do not use the air conditioner in special environments.
 - Oil, steam, sulfuric smoke, etc. can significantly reduce the performance of the air conditioner or damage its parts.
- Do not block the inlet or outlet.
 - It may cause failure of appliance or accident.
- Make the connections securely so that the outside force of the cable may not be applied to the terminals.
 - Inadequate connection and fastening may generate heat and cause a fire.
- Be sure the installation area does not deteriorate with age.
 - If the base collapses, the air conditioner could fall with it, causing property damage, product failure, or personal injury.

- Install and insulate the drain hose to ensure that water is drained away properly based on the installation manual.
 - A bad connection may cause water leakage.
- Be very careful about product transportation.
 - Only one person should not carry the product if it weighs more than 44lbs (20kg).
 - Some products use PP bands for packaging. Do not use any PP bands for a means of transportation. It is dangerous.
 - Do not touch the heat exchanger fins. Doing so may cut your fingers.
 - When transporting the outdoor unit, suspending it at the specified positions on the unit base. Also support the outdoor unit at four points so that it cannot slip sideways.
- Safely dispose of the packing materials.
 - Packing materials, such as nails and other metal or wooden parts, may cause stabs or other injuries.
 - Tear apart and throw away plastic packaging bags so that children may not play with them. If children play with a plastic bag which was not torn apart, they face the risk of suffocation.
- Turn on the power at least 6 hours before starting operation.
 - Starting operation immediately after turning on the main power switch can result in severe damage to internal parts. Keep the power switch turned on during the operational season.
- Do not touch any of the refrigerant piping during and after operation.
 - It can cause a burn or frostbite.
- Do not operate the air conditioner with the panels or guards removed.
 - Rotating, hot, or high-voltage parts can cause injuries.
- Do not directly turn off the main power switch after stopping operation.
 - Wait at least 5 minutes before turning off the main power switch. Otherwise it may result in water leakage or other problems.
- Auto-addressing should be done in condition of connecting the power of all indoor and outdoor units. Auto-addressing should also be done in case of changing the indoor unit PCB.
- Use a firm stool or ladder when cleaning or maintaining the air conditioner.
 - Be careful and avoid personal injury.
- Do not insert hands or other objects through the air inlet or outlet while the air conditioner is plugged in.
 - There are sharp and moving parts that could cause personal injury.

Installation Process

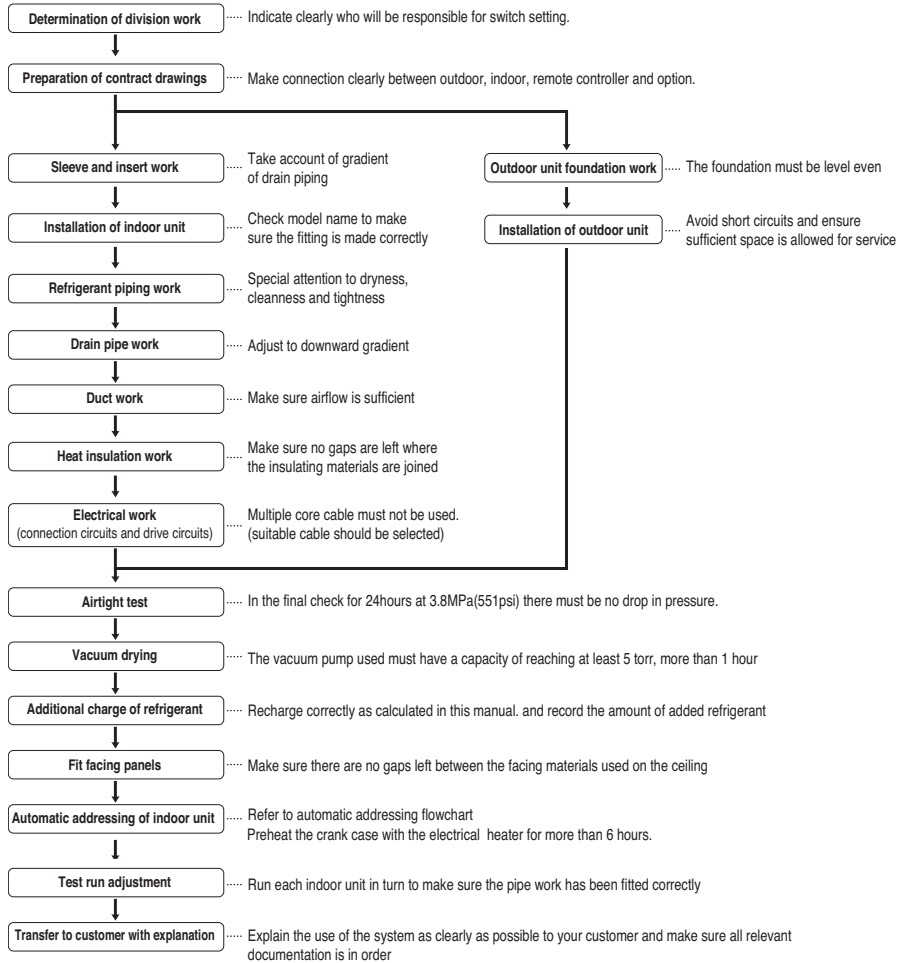

⚠ CAUTION

- The above list indicates the order in which the individual work operations are normally carried out but this order may be varied where local conditions warrants such change.
- The wall thickness of the piping should comply with the relevant local and national regulations for the designed pressure 3.8MPa(551psi).
- Since R410A is a mixed refrigerant, the required additional refrigerant must be charged in its liquid state.(If the refrigerant is charged in its gaseous state, its composition changes and the system will not work properly.)

Outdoor units Information

⚠ CAUTION

■ Combination Ratio(50~130%)

Outdoor Number	Connection Capacity
Single outdoor unit	130%
Double outdoor units	130%
Triple outdoor units	130%

Notes: * We can guarantee the operation only within 130% Combination.

Power Supply: Outdoor Unit (3Ø, 208/230V, 60Hz)

■ Heat pump

Unit		1 Outdoor Unit		
System	HP	8	10	12
	Ton	6	8	10
Model		ARUN072BT3	ARUN096BT3	ARUN121BT3
		ARUN072BT3	ARUN096BT3	ARUN121BT3
Product Charge	kg	5.5	9.4	9.4
	lbs	12.1	20.7	20.7
Max. Connectable No. of Indoor Units		13	16	20
Net Weight	kg	190 x 1	280 x 1	280 x 1
	lbs	418 x 1	617 x 1	617 x 1
Dimensions (WxHxD)	mm	(920×1,680×760)×1	(1,240×1,680×760)×1	(1,240×1,680×760)×1
	inch	(36.2×66.1×29.9)×1	(48.8×66.1×29.9)×1	(48.8×66.1×29.9)×1
Connecting Pipes	Liquid Pipes[mm(inch)]	9.52(3/8)	9.52(3/8)	12.7(1/2)
	Gas Pipes[mm(inch)]	19.05(3/4)	22.2(7/8)	28.58(1 1/8)

Unit		1 Outdoor Unit	2 Outdoor Unit	
System	HP	14	18	20
	Ton	12	14	16
Model		ARUN144BT3	ARUN168BT3	ARUN192BT3
		ARUN144BT3	ARUN072BT3 ARUN096BT3	ARUN072BT3 ARUN121BT3
Product Charge	kg	9.4	14.9	14.9
	lbs	20.7	32.8	32.8
Max. Connectable No. of Indoor Units		23	26	29
Net Weight	kg	280 x 1	(190 x 1) + (280 x 1)	(190 x 1) + (280 x 1)
	lbs	617 x 1	(418 x 1) + (617 x 1)	(418 x 1) + (617 x 1)
Dimensions (WxHxD)	mm	(1,240×1,680×760)×1	(920×1,680×760)×1 (1,240×1,680×760)×1	(920×1,680×760)×1 (1,240×1,680×760)×1
	inch	(48.8×66.1×29.9)×1	(36.2×66.1×29.9)×1 (48.8×66.1×29.9)×1	(36.2×66.1×29.9)×1 (48.8×66.1×29.9)×1
Connecting Pipes	Liquid Pipes[mm(inch)]	12.7(1/2)	15.88(5/8)	15.88(5/8)
	Gas Pipes[mm(inch)]	28.58(1 1/8)	28.58(1 1/8)	28.58(1 1/8)

Outdoor units Information

Unit		2 Outdoor Unit		
System	HP	22	24	26
	Ton	18	20	22
Model		ARUN216BT3	ARUN240BT3	ARUN264BT3
		ARUN072BT3	ARUN096BT3	ARUN121BT3
		ARUN144BT3	ARUN144BT3	ARUN144BT3
Product Charge	kg	14.9	19	19
	lbs	32.8	41	41
Max. Connectable No. of Indoor Units		32	35	39
Net Weight	kg	(190 × 1) + (280 × 1)	280 × 2	280 × 2
	lbs	(418 × 1) + (617 × 1)	617 × 2	617 × 2
Dimensions (WxHxD)	mm	(920×1,680×760)×1 (1,240×1,680×760)×1	(1,240×1,680×760)×2	(1,240×1,680×760)×2
	inch	(36.2×66.1×29.9)×1 (48.8×66.1×29.9)×1	(48.8×66.1×29.9)×2	(48.8×66.1×29.9)×2
Connecting Pipes	Liquid Pipes[mm(inch)]	15.88(5/8)	15.88(5/8)	19.05(3/4)
	Gas Pipes[mm(inch)]	28.58(1 1/8)	34.9(1 3/8)	34.9(1 3/8)

Unit		2 Outdoor Unit	3 Outdoor Unit	
System	HP	28	32	34
	Ton	24	26	28
Model		ARUN288BT3	ARUN312BT3	ARUN336BT3
		ARUN144BT3	ARUN072BT3	ARUN072BT3
		ARUN144BT3	ARUN096BT3	ARUN121BT3
			ARUN144BT3	ARUN144BT3
Product Charge	kg	19	24.3	24.3
	lbs	41	53.5	53.5
Max. Connectable No. of Indoor Units		42	45	49
Net Weight	kg	280 × 2	(190 × 1) + (280 × 2)	(190 × 1) + (280 × 2)
	lbs	617 × 2	(418 × 1) + (617 × 2)	(418 × 1) + (617 × 2)
Dimensions (WxHxD)	mm	(1,240×1,680×760)×2	(920×1,680×760)×1 (1,240×1,680×760)×2	(920×1,680×760)×1 (1,240×1,680×760)×2
	inch	(48.8×66.1×29.9)×2	(36.2×66.1×29.9)×1 (48.8×66.1×29.9)×2	(36.2×66.1×29.9)×1 (48.8×66.1×29.9)×2
Connecting Pipes	Liquid Pipes[mm(inch)]	19.05(3/4)	19.05(3/4)	19.05(3/4)
	Gas Pipes[mm(inch)]	34.9(1 3/8)	34.9(1 3/8)	34.9(1 3/8)

Unit		1 Outdoor Unit	2 Outdoor Unit	
System	HP	36	38	40
	Ton	30	32	34
Model		ARUN360BT3	ARUN384BT3	ARUN408BT3
		ARUN072BT3	ARUN096BT3	ARUN121BT3
		ARUN144BT3	ARUN144BT3	ARUN144BT3
		ARUN144BT3	ARUN144BT3	ARUN144BT3
Product Charge	kg	24.3	28.2	28.2
	lbs	53.5	62.1	62.1
Max. Connectable No. of Indoor Units		52	55	58
Net Weight	kg	(190 × 1) + (280 × 2)	280 × 3	280 × 3
	lbs	(418 × 1) + (617 × 2)	617 × 3	617 × 3
Dimensions (WxHxD)	mm	(920×1,680×760)×1 (1,240×1,680×760)×2	(1,240×1,680×760)×3	(1,240×1,680×760)×3
	inch	(36.2×66.1×29.9)×1 (48.8×66.1×29.9)×2	(48.8×66.1×29.9)×3	(48.8×66.1×29.9)×3
Connecting Pipes	Liquid Pipes[mm(inch)]	19.05(3/4)	19.05(3/4)	19.05(3/4)
	Gas Pipes[mm(inch)]	41.3(1 5/8)	41.3(1 5/8)	41.3(1 5/8)

Unit		3 Outdoor Unit	
System	HP	42	
	Ton	36	
Model	ARUN432BT3		
	ARUN144BT3		
	ARUN144BT3		
	ARUN144BT3		
Product Charge	kg	28.2	
	lbs	62.1	
Max. Connectable No. of Indoor Units		61	
Net Weight	kg	280 × 3	
	lbs	617 × 3	
Dimensions (WxHxD)	mm	(1,240×1,680×760)×3	
	inch	(48.8×66.1×29.9)×3	
Connecting Pipes	Liquid Pipes[mm(inch)]	19.05(3/4)	
	Gas Pipes[mm(inch)]	41.3(1 5/8)	

Power Supply: Outdoor Unit (3Ø, 460V, 60Hz)

Unit		1 Outdoor Unit			
System	HP	8	10	12	
	Ton	6	8	10	
Model	ARUN072DT3		ARUN096DT3	ARUN120DT3	
	ARUN072DT3		ARUN096DT3	ARUN120DT3	
Product Charge	kg	5.5	9.4	9.4	
	lbs	12.1	20.7	20.7	
Max. Connectable No. of Indoor Units		13	16	20	
Net Weight	kg	190 × 1	270 × 1	270 × 1	
	lbs	418 × 1	595 × 1	595 × 1	
Dimensions (WxHxD)	mm	(920×1,680×760)×1	(1,240×1,680×760)×1	(1,240×1,680×760)×1	
	inch	(36.2×66.1×29.9)×1	(48.8×66.1×29.9)×1	(48.8×66.1×29.9)×1	
Connecting Pipes	Liquid Pipes[mm(inch)]	9.52(3/8)	9.52(3/8)	12.7(1/2)	
	Gas Pipes[mm(inch)]	19.05(3/4)	22.2(7/8)	28.58(1 1/8)	

Unit		1 Outdoor Unit		2 Outdoor Unit	
System	HP	14		18	20
	Ton	12		14	16
Model	ARUN144DT3		ARUN168DT3	ARUN192DT3	
	ARUN144DT3		ARUN072DT3	ARUN072DT3	
			ARUN096DT3	ARUN120DT3	
Product Charge	kg	9.4		14.9	14.9
	lbs	20.7		32.8	32.8
Max. Connectable No. of Indoor Units		23		26	29
Net Weight	kg	270 × 1		(190 × 1) + (270 × 1)	(190 × 1) + (270 × 1)
	lbs	595 × 1		(418 × 1) + (595 × 1)	(418 × 1) + (595 × 1)
Dimensions (WxHxD)	mm	(1,240×1,680×760)×1		(920×1,680×760)×1 (1,240×1,680×760)×1	(920×1,680×760)×1 (1,240×1,680×760)×1
	inch	(48.8×66.1×29.9)×1		(36.2×66.1×29.9)×1 (48.8×66.1×29.9)×1	(36.2×66.1×29.9)×1 (48.8×66.1×29.9)×1
Connecting Pipes	Liquid Pipes[mm(inch)]	12.7(1/2)		15.88(5/8)	15.88(5/8)
	Gas Pipes[mm(inch)]	28.58(1 1/8)		28.58(1 1/8)	28.58(1 1/8)

Outdoor Units Information

Unit		2 Outdoor Unit		
System	HP	22	24	26
	Ton	18	20	22
Model		ARUN216DT3	ARUN240DT3	ARUN264DT3
		ARUN072DT3	ARUN096DT3	ARUN120DT3
		ARUN144DT3	ARUN144DT3	ARUN144DT3
Product Charge	kg	14.9	19	19
	lbs	32.8	41	41
Max. Connectable No. of Indoor Units		32	35	39
Net Weight	kg	(190 × 1) + (270 × 1)	270 × 2	270 × 2
	lbs	(418 × 1) + (595 × 1)	595 × 2	595 × 2
Dimensions (WxHxD)	mm	(920×1,680×760)×1 (1,240×1,680×760)×1	(1,240×1,680×760)×2	(1,240×1,680×760)×2
	inch	(36.2×66.1×29.9)×1 (48.8×66.1×29.9)×1	(48.8×66.1×29.9)×2	(48.8×66.1×29.9)×2
Connecting Pipes	Liquid Pipes[mm(inch)]	15.88(5/8)	15.88(5/8)	19.05(3/4)
	Gas Pipes[mm(inch)]	28.58(1 1/8)	34.9(1 3/8)	34.9(1 3/8)

Unit		2 Outdoor Unit	3 Outdoor Unit	
System	HP	28	32	34
	Ton	24	26	28
Model		ARUN288DT3	ARUN312DT3	ARUN336DT3
		ARUN144DT3	ARUN072DT3	ARUN072DT3
		ARUN144DT3	ARUN096DT3	ARUN120DT3
Product Charge	kg	19	24.3	24.3
	lbs	41	53.5	53.5
Max. Connectable No. of Indoor Units		42	45	49
Net Weight	kg	270 × 2	(190 × 1) + (270 × 2)	(190 × 1) + (270 × 2)
	lbs	595 × 2	(418 × 1) + (595 × 2)	(418 × 1) + (595 × 2)
Dimensions (WxHxD)	mm	(1,240×1,680×760)×2	(920×1,680×760)×1 (1,240×1,680×760)×2	(920×1,680×760)×1 (1,240×1,680×760)×2
	inch	(48.8×66.1×29.9)×2	(36.2×66.1×29.9)×1 (48.8×66.1×29.9)×2	(36.2×66.1×29.9)×1 (48.8×66.1×29.9)×2
Connecting Pipes	Liquid Pipes[mm(inch)]	19.05(3/4)	19.05(3/4)	19.05(3/4)
	Gas Pipes[mm(inch)]	34.9(1 3/8)	34.9(1 3/8)	34.9(1 3/8)

Unit		3 Outdoor Unit		
System	HP	36	38	40
	Ton	30	32	34
Model		ARUN360DT3	ARUN384DT3	ARUN408DT3
		ARUN072DT3	ARUN096DT3	ARUN120DT3
		ARUN144DT3	ARUN144DT3	ARUN144DT3
		ARUN144DT3	ARUN144DT3	ARUN144DT3
Product Charge	kg	24.3	28.2	28.2
	lbs	53.5	62.1	62.1
Max. Connectable No. of Indoor Units		52	55	58
Net Weight	kg	(190 × 1) + (270 × 2)	270 × 3	270 × 3
	lbs	(418 × 1) + (595 × 2)	595 × 3	595 × 3
Dimensions (WxHxD)	mm	(920×1,680×760)×1 (1,240×1,680×760)×2	(1,240×1,680×760)×3	(1,240×1,680×760)×3
	inch	(36.2×66.1×29.9)×1 (48.8×66.1×29.9)×2	(48.8×66.1×29.9)×3	(48.8×66.1×29.9)×3
Connecting Pipes	Liquid Pipes[mm(inch)]	19.05(3/4)	19.05(3/4)	19.05(3/4)
	Gas Pipes[mm(inch)]	41.3(1 5/8)	41.3(1 5/8)	41.3(1 5/8)

Unit		3 Outdoor Unit
System	HP	42
	Ton	36
Model		ARUN432DT3
		ARUN144DT3
		ARUN144DT3
		ARUN144DT3
Product Charge	kg	28.2
	lbs	62.1
Max. Connectable No. of Indoor Units		61
Net Weight	kg	270 × 3
	lbs	595 × 3
Dimensions (W×H×D)	mm	(1,240×1,680×760)×3
	inch	(48.8×66.1×29.9)×3
Connecting Pipes	Liquid Pipes[mm(inch)]	19.05(3/4)
	Gas Pipes[mm(inch)]	41.3(1 5/8)

Alternative Refrigerant R410A

- The refrigerant R410A has the property of higher operating pressure in comparison with R22. Therefore, all materials have the characteristics of higher resisting pressure than R22 ones and this characteristic should be also considered during the installation.
R410A is an azeotrope of R32 and R125 mixed at 50:50, so the ozone depletion potential (ODP) of R410A is 0.



CAUTION:

- The wall thickness of the piping should comply with the relevant local and national regulations for the designed pressure 3.8MPa(551.1psi).
- Since R410A is a mixed refrigerant, the required additional refrigerant must be charged in its liquid state. If the refrigerant is charged in its gaseous state, its composition changes and the system will not work properly.
- Do not place the refrigerant container under the direct rays of the sun to prevent it from exploding.
- For high-pressure refrigerant, any unapproved pipe must not be used.
- Do not heat pipes more than necessary to prevent them from softening.
- Be careful not to install wrongly to minimize economic loss because it is expensive in comparison with R22.

Select the Best Location

Select space for installing outdoor unit, which will meet the following conditions:

- No direct thermal radiation from other heat sources
- No possibility of annoying neighbors by noise from unit
- No exposition to strong wind
- With strength which bears weight of unit
- Note that drain flows out of unit when heating
- With space for air passage and service work shown next
- Because of the possibility of fire, do not install unit to the space where generation, inflow, stagnation, and leakage of combustible gas is expected.
- Avoid unit installation in a place where acidic solution and spray (sulfur) are often used.
- Do not use unit under any special environment where oil, steam and sulfuric gas exist.
- It is recommended to fence round the outdoor unit in order to prevent any person or animal from accessing the outdoor unit.
- If installation site is area of heavy snowfall, then the following directions should be observed.
 - Make the foundation as high as possible.
 - Fit a snow protection hood.
- Select installation location considering following conditions to avoid bad condition when additionally performing defrost operation.
 1. Install the outdoor unit at a place well ventilated and having a lot of sunshine in case of installing the product at a place With a high humidity in winter (near beach, coast, lake, etc.)
(Ex : Rooftop where there is always sunshine.)

Installation Space

Individual Installation

- During the installation of the unit, consider service, inlet, and outlet and acquire the minimum space as shown in the figures below.

Category	Installation Space	Case 1 (10mm ≤ Space A, C ≤ 49mm)	Case 2 (Space A, C ≥ 49mm)
4 sides are walls		A ≥ 10(13/32") B ≥ 300(11-13/16") C ≥ 10(13/32") D ≥ 500(19-11/16")	A ≥ 50(1-31/32") B ≥ 100(3-15/16") C ≥ 50(1-31/32") D ≥ 500(19-11/16")
		A ≥ 10(13/32") B ≥ 300(11-13/16") C ≥ 10(13/32") D ≥ 500(19-11/16") E ≥ 20(25/32")	A ≥ 50(1-31/32") B ≥ 100(3-15/16") C ≥ 50(1-31/32") D ≥ 500(19-11/16") E ≥ 100(3-15/16")
		A ≥ 10(13/32") B ≥ 300(11-13/16") C ≥ 10(13/32") D ≥ 500(19-11/16") E ≥ 20(25/32") F ≥ 600(23-5/8")	A ≥ 50(1-31/32") B ≥ 100(3-15/16") C ≥ 50(1-31/32") D ≥ 500(19-11/16") E ≥ 100(3-15/16") F ≥ 500(19-11/16")
		A ≥ 10(13/32") B ≥ 300(11-13/16") C ≥ 10(13/32") D ≥ 300(11-13/16") E ≥ 20(25/32") F ≥ 500(19-11/16")	A ≥ 50(1-31/32") B ≥ 100(3-15/16") C ≥ 50(1-31/32") D ≥ 100(3-15/16") E ≥ 100(3-15/16") F ≥ 500(19-11/16")
Only 2 sides are walls		A ≥ 10(13/32") B ≥ 300(11-13/16")	
		A ≥ 200(7-7/8") B ≥ 300(11-13/16") E ≥ 400(15-3/4")	
Limitations on the height of the wall (Refer to 4 side walls)		<ul style="list-style-type: none"> The height of the wall on the front side must be 1500mm(59-1/16 inch) or less. The height of the wall on the inlet side must be 500mm(19-11/16 inch) or less. There is no limit to the wall on the side. If the height of the walls on the front and the inlet are higher than the limit, there must be additional space on the front and the side. <ul style="list-style-type: none"> - Additional Space on the inlet side by 1/2 of h1. - Additional Space on the front side by 1/2 of h2 - h2 = A(Actual height) - 59-1/16 - h1 = B(Actual height) - 19-11/16 	

Seasonal wind and cautions in winter

- Sufficient measures are required in a snow area or severe cold area in winter so that product can be operated well.
- Get ready for seasonal wind or snow in winter even in other areas.
- Install a suction and discharge duct not to let in snow or rain.
- Install the outdoor unit not to come in contact with snow directly. If snow piles up and freezes on the air suction hole, the system may malfunction. If it is installed at snowy area, attach the hood to the system.
- Install the outdoor unit at the higher installation console by 500mm(19-11/16inch) inch than the average snowfall (annual average snowfall) if it is installed at the area with much snowfall.
- Where snow accumulated on the upper part of the Outdoor Unit by more than 100mm(3-15/16inch), always remove snow for operation.

- | |
|--------------------------------------------------------------------------------------------------------------------------------------------------------------------------------------------------------------------------------------------------------------------------------------------------------------------------------------------------------------------|
| <ol style="list-style-type: none">1. The height of H frame must be more than 2 times the snowfall and its width shall not exceed the width of the product. (If width of the frame is wider than that of the product, snow may accumulate)2. Don't install the suction hole and discharge hole of the Outdoor Unit facing the seasonal wind. |
|--------------------------------------------------------------------------------------------------------------------------------------------------------------------------------------------------------------------------------------------------------------------------------------------------------------------------------------------------------------------|

Lifting method

- When carrying the suspended, unit pass the ropes under the unit and use the two suspension points each at the front and rear.
- Always lift the unit with ropes attached at four points so that impact is not applied to the unit.
- Attach the ropes to the unit at an angle of 40° or less.

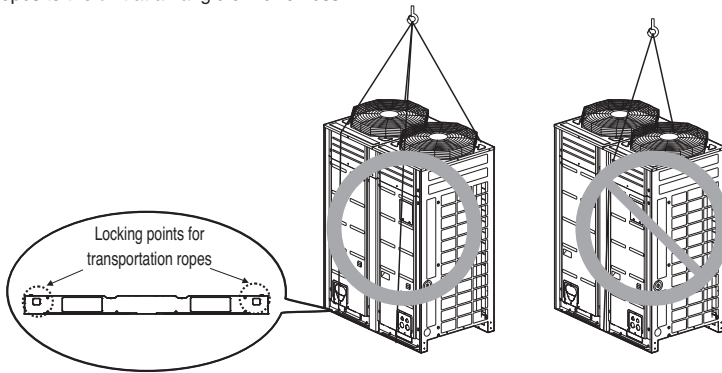

Weight per Capacity

Chassis	Capacity [HP(Ton)]	Weight [kg(lbs)]	
		3Ø 208/230V	3Ø 460V
UX2	8 (6)	190 (418)	190 (418)
	10 (8)	280 (617)	270 (595)
UX3	12 (10)	280 (617)	270 (595)
	14 (12)	280 (617)	270 (595)

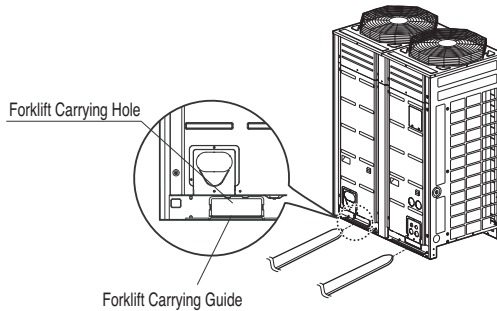

⚠ CAUTION

Be very careful while carrying the product.

- Do not have only one person carry product if it is more than 20kg(44lbs).
- PP bands are used to pack some products. Do not use them as a mean for transportation because they are dangerous.
- Do not touch heat exchanger fins with your bare hands. Otherwise you may get a cut in your hands.
- Tear plastic packaging bag and scrap it so that children cannot play with it. Otherwise plastic packaging bag may suffocate children to death.
- When carrying in Outdoor Unit, be sure to support it at four points. Carrying in and lifting with 3-point support may make Outdoor Unit unstable, resulting in a fall.
- Use 2 belts of at least 3m(26.2ft) long.
- Place extra cloth or boards in the locations where the casing comes in contact with the sling to prevent damage.
- Hoist the unit making sure it is being lifted at its center of gravity.

Installation

- Install at places where it can endure the weight and vibration/noise of the outdoor unit.
- The outdoor unit supports at the bottom shall have width of at least 100mm(3-15/16 inch) under the units legs before being fixed.
- The outdoor unit supports should have minimum height of 200mm(7-7/8 inch).
- Anchor bolts (M10) must be inserted at least 75mm(2-15/16 inch).

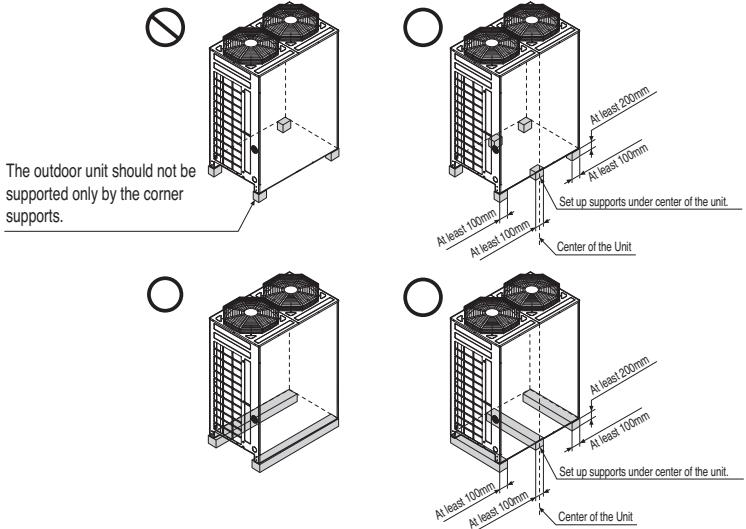

The location of the Anchor bolts

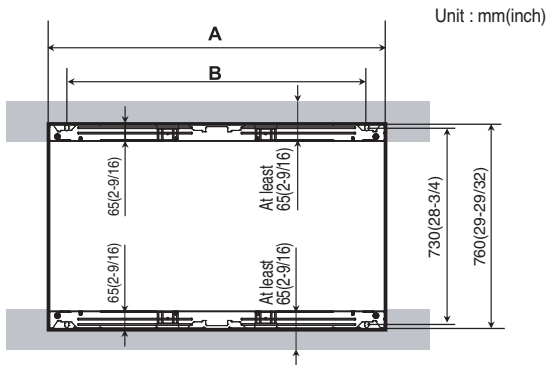

Chassis	Outdoor unit capacity	A [mm(inch)]	B [mm(inch)]
	H/R		
UX2	8HP	920(36-7/32)	792(31-3/16)
UX3	10~14HP	1240(48-13/16)	1102(43-3/8)

Foundation for Installation

- Fix the unit tightly with bolts as shown below so that unit will not fall down due to earthquake or gust.
- Use the H-beam support as a base support
- Noise and vibration may occur from the floor or wall since vibration is transferred through the installation part depending on installation status. Thus, use anti-vibration materials (cushion pad) fully (The base pad shall be more than 200mm(7-7/8 inch).

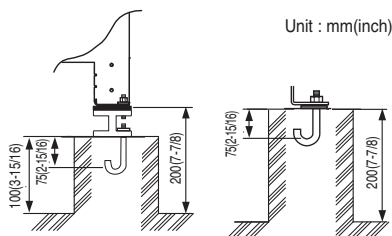
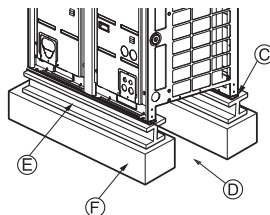
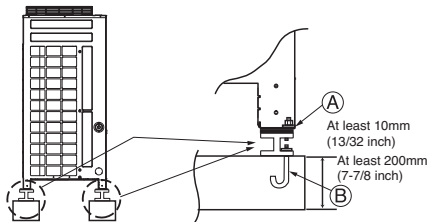

- Ⓐ The corner part must be fixed firmly. Otherwise, the support for the installation may be bent.
- Ⓑ Get and use M10 Anchor bolt.
- Ⓒ Put Cushion Pad between the outdoor unit and ground support for the vibration protection in wide area.
- Ⓓ Space for pipes and wiring (Pipes and wirings for bottom side)
- Ⓔ H-beam support
- Ⓕ Concrete support

! WARNING

- Install where it can sufficiently support the weight of the outdoor unit.
If the support strength is not enough, the outdoor unit may drop and hurt people.
- Install where the outdoor unit may not fall in strong wind or earthquake.
- If there is a fault in the supporting conditions, the outdoor unit may fall and hurt people.
- Please take extra cautions on the supporting strength of the ground, liquid outlet treatment (treatment of the liquid flowing out of the outdoor unit in operation), and the passages of the pipe and wiring, when making the ground support.
- Do not use tube or pipe for liquid outlet in the Base pan. Use drainage instead for liquid outlet. The tube or pipe may freeze and the liquid may not be drained.

! WARNING

- Be sure to remove the MDF (wood support) of the bottom side of the outdoor unit Base Pan before fixing the bolt. It may cause the unstable state of the outdoor settlement, and may cause freezing of the heat exchanger resulting in abnormal operations.
- Be sure to remove the MDF (wood support) of the bottom side of the outdoor unit before welding. Not removing MDF causes hazard of fire during welding.

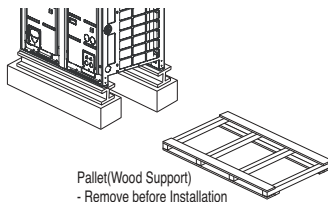

Preparation of Piping

Main cause of gas leakage is defect in flaring work. Carry out correct flaring work in the following procedure.

1) Cut the pipes and the cable.

- Use the accessory piping kit or the pipes purchased locally.
- Measure the distance between the indoor and the outdoor unit.
- Cut the pipes a little longer than measured distance.

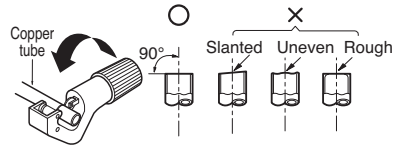

2) Burrs removal

- Completely remove all burrs from the cut cross section of pipe/tube.
- Put the end of the copper tube/pipe to downward direction as you remove burrs in order to avoid to let burrs drop in the tubing.

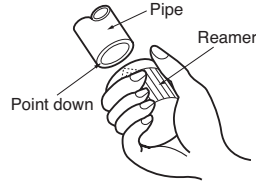

3) Flaring work

- Carry out flaring work using flaring tool as shown below.

Pipe diameter Inch (mm)	A inch (mm)	
	Wing nut type	Clutch type
Ø1/4 (Ø6.35)	0.04~0.07 (1.1~1.8)	0~0.02 (0~0.5)
Ø3/8 (Ø9.52)		
Ø1/2 (Ø12.7)		
Ø5/8 (Ø15.88)		

- For below models, carry out flaring work using flaring tool as shown below.

Applicable Indoor unit models:

ARNU093TN★2, ARNU123TN★2, ARNU153TN★2,
ARNU183TM★2, ARNU243TM★2, ARNU153BG★2,
ARNU183BG★2, ARNU243BG★2

Pipe [inch]		"A" [inch(mm)]	
Gas	Liquid	Gas	Liquid
5/8	3/8	0.03~0.04	0.02~0.03
		(0.8~1.0)	(0.5~0.8)

- Firmly hold copper tube in a bar (or die) as indicated dimension in the table above.

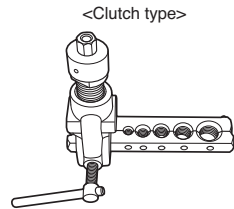
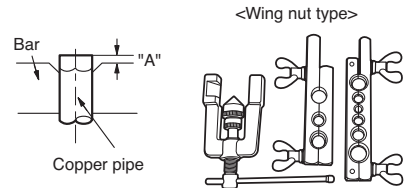

4) Check

- Compare the flared work with figure below.
- If flare is noted to be defective, cut off the flared section and do flaring work again.

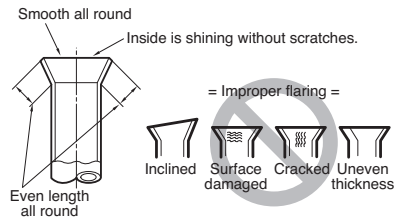

FLARE SHAPE and FLARE NUT TIGHTENING TORQUE

Precautions when connecting pipes

- See the following table for flare part machining dimensions.
- When connecting the flare nuts, apply refrigerant oil to the inside and outside of the flares and turn them three or four times at first. (Use ester oil or ether oil.)
- See the following table for tightening torque.(Applying too much torque may cause the flares to crack.)
- After all the piping has been connected, use nitrogen to perform a gas leak check.

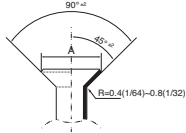
Pipe size [inch(mm)]	Tightening torque [lbf-in(Ncm)]	A [inch(mm)]	flare shape
Ø3/8(9.52)	289.4(3270)-353.1(3990)	0.5(12.8)-0.52(13.2)	
Ø1/2(12.7)	438.1(4950)-533.7(6030)	0.64(16.2)-0.65(16.6)	
Ø5/8(15.88)	547.0(6180)-667.3(7540)	0.76(19.3)-0.78(19.7)	

CAUTION

- Always use a charge hose for service port connection.
- After tightening the cap, check that no refrigerant leaks are present.
- When loosening a flare nut, always use two wrenches in combination. When connecting the piping, always use a spanner and torque wrench in combination to tighten the flare nut.
- When connecting a flare nut, coat the flare(inner and outer faces) with oil for R410A(PVE) and hand tighten the nut 3 to 4 turns as the initial tightening.

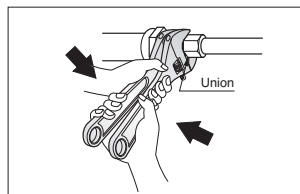

Opening shutoff valve

1. Remove the cap and turn the valve counter clockwise with the hexagon wrench.
2. Turn it until the shaft stops.

Do not apply excessive force to the shutoff valve. Doing so may break the valve body, as the valve is not a backseat type. Always use the special tool.

3. Make sure to tighten the cap securely.

Closing shutoff valve

1. Remove the cap and turn the valve clockwise with the hexagon wrench.
2. Securely tighten the valve until the shaft contacts the main body seal.
3. Make sure to tighten the cap securely.

* For the tightening torque, refer to the table on the below.

Tightening torque

Shutoff valve size	Tightening torque(Turn clockwise to close) [N·m(lbf·ft)]				
	Shaft(valve body)		Cap(Valve lid)	Service port	Flare nut
Ø6.35(1/4)	5.4(4.0) ~ 6.6(4.9)	Hexagonal wrench 4mm (5/8inch)	13.5(10.0) ~ 16.5(12.2)	11.5(8.5) ~ 13.9(10.3)	14(10.3) ~ 17(12.5)
Ø9.52(3/8)			18(13.3) ~ 22(16.2)		33(24.3) ~ 39(28.8)
Ø12.7(1/2)			23(17.0) ~ 27(19.9)		50(36.9) ~ 60(44.3)
Ø15.88(5/8)	27(19.9) ~ 33(24.3)	Hexagonal wrench 8mm(5/16inch)	36(26.6) ~ 44(32.5)		62(45.7) ~ 75(55.3)
Ø19.05(3/4)					93(68.6) ~ 119(87.8)
Ø22.2(7/8)					-
Ø28(1 1/8)					

HEAT INSULATION

1. Use the heat insulation material for the refrigerant piping which has an excellent heat-resistance (over 248°F(120°C)).
2. Precautions in high humidity circumstance:

This air conditioner has been tested according to the "ISO Conditions with Mist" and confirmed that there is not any default. However, if it is operated for a long time in high humid atmosphere (dew point temperature: more than 73°F(23°C)), water drops are liable to fall. In this case, add heat insulation material according to the following procedure:

- EPDM (Ethylene Propylene Diene Methylene), NBR (Nitrile Butadiene Rubber) – over 248°F(120°C) the heat-resistance temperature.
- Add the insulation over 10mm (13/32inch) thickness at high humidity environment.

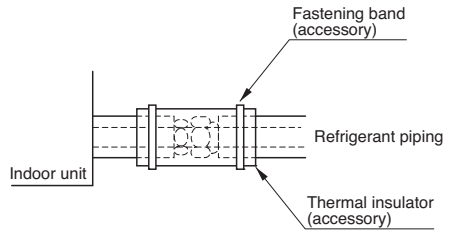

Refrigerant piping installation

Precautions on Pipe connection / Valve operation

Pipe connection is done by connecting from the end of the pipe to the branching pipes, and the refrigerant pipe coming out of the outdoor unit is divided at the end to connect to each indoor unit. Flare connection for the indoor unit, and welding connection for the outdoor pipe and the branching parts.

- Use hexagonal wrench to open/close the valve.

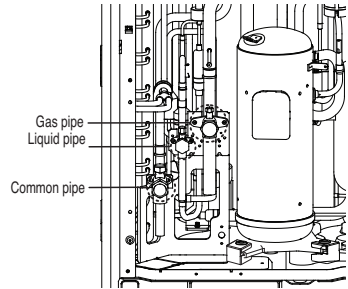

! WARNING

- Always careful not to leak the refrigerant during welding.
- The refrigerant generates poisonous gas harmful to human body if combusted.
- Do not perform welding in a closed space.
- Be sure to close the cap of the service port to prevent gas leakage after the work.

! CAUTION

Please block the pipe knock outs of the front and side panels after installing the pipes.
(Animals or foreign objects may be brought in to damage the cables.)

High Low Pressure Common Pipe Connections

1. For High Low Pressure Common Pipe, use provided elbows to connect between the outdoor units using pipes.
2. During the cutting of the pipes, remove burr, foreign substances before connecting. Otherwise, the unit may not operate because of the sludge inside the pipe.
3. Apply Nitrogen Gas of pressure until 551.1psi(38.7kgf/cm²) for work area leakage test.
4. After the degree of a vacuum reaches 0.097psi(5torr), continue the vacuuming work for more than 1 hour.
5. Open the side pole with hexagonal wrench.

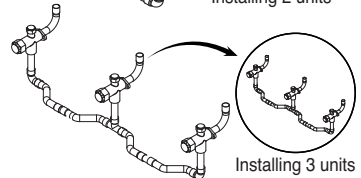
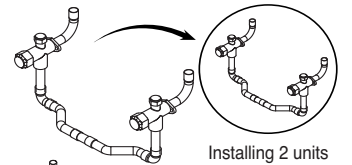

※ When connecting to high low pressure common pipe, connect pipes using connecting elbows.

Detach knock outs according the usages.

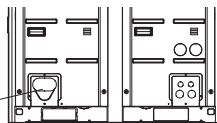

Installing on the front side

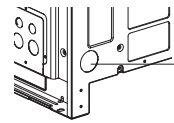

Installing on the side(Limited to high low pressure common pipe)

Detach knock outs according the usages.

Connection of Outdoor units

2 outdoor units

[Unit: inch(mm)]

Outdoor units		Model	Gas pipe	Liquid pipe
2 Unit		© ARCNN21		
3 Unit		ⓑ ARCNN31		

For more information, refer accessory installation manual.

Common pipes

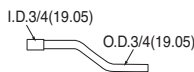
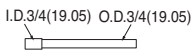

Field Supply (Not provided by LG)

■ Y branch



- (A) To outdoor unit
- (B) To branch piping or indoor unit

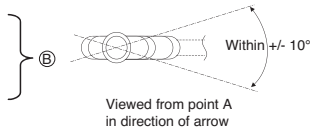

Facing downwards

Facing upwards

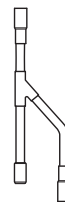

Within ± 3°

Within ± 3°

Caution

- Use the following materials for refrigerant piping.
 - Material: Seamless phosphorous deoxidized copper pipe
 - Wall thickness : Comply with the relevant local and national regulations for the designed pressure 3.8Mpa(551.1psi). We recommend the following table as the minimum wall thickness.

Outer diameter [mm(inch)]	6.35 (1/4)	9.52 (3/8)	12.7 (1/2)	15.88 (5/8)	19.05 (3/4)	22.2 (7/8)	25.4 (1)	28.58 (1-1/8)	31.8 (1-1/4)	34.9 (1-3/8)	38.1 (1-1/2)	41.3 (1-5/8)	
Minimum thickness [mm(inch)]	0.8 (0.0315)	0.8 (0.0315)	0.8 (0.0315)	0.99 (0.039)	0.99 (0.039)	0.99 (0.039)	0.99 (0.039)	0.99 (0.039)	0.99 (0.039)	1.1 (0.043)	1.21 (0.048)	1.35 (0.053)	1.43 (0.056)

- Commercially available piping often contains dust and other materials. Always blow it clean with a dry inert gas.
- Use care to prevent dust, water or other contaminants from entering the piping during installation.
- Reduce the number of bending portions as much as possible, and make bending radius as big as possible.
- Always use the branch piping set shown below, which are sold separately.

Y branch	Header		
	4 branch	7 branch	10 branch
ARBLN01621, ARBLN03321, ARBLN07121, ARBLN14521	ARBL054	ARBL057	ARBL1010
	ARBL104	ARBL107	ARBL2010

- If the diameters of the branch piping of the designated refrigerant piping differs, use a pipe cutter to cut the connecting section and then use an adapter for connecting different diameters to connect the piping.
- Always observe the restrictions on the refrigerant piping (such as rated length, difference in height, and piping diameter). Failure to do so can result in equipment failure or a decline in heating/cooling performance.
- A second branch cannot be made after a header. (These are shown by ⊗.)

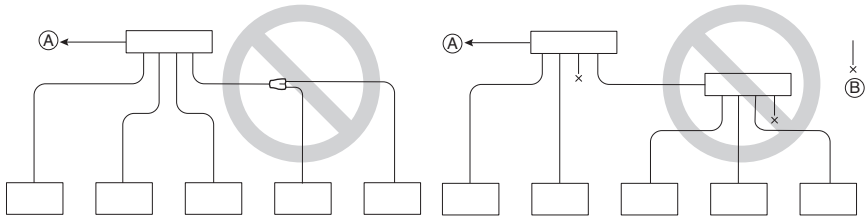

(A) To Outdoor Unit
 (B) Sealed Piping

- The Multi V will stop due to an abnormality like excessive or insufficient refrigerant. At such a time, always properly charge the unit. When servicing, always check the notes concerning both the piping length and the amount of additional refrigerant.
- Never perform a pump down. This will not only damage the compressor but also deteriorate the performance.
- Never use refrigerant to perform an air purge. Always evacuate air by using a vacuum pump.

12. Always insulate the piping properly. Insufficient insulation will result in a decline in heating/cooling performance, drip of condensate and other such problems.
13. When connecting the refrigerant piping, make sure the service valves of the Outdoor Unit is completely closed (the factory setting) and do not operate it until the refrigerant piping for the Outdoor and Indoor Units has been connected, a refrigerant leakage test has been performed and the evacuation process has been completed.
14. Always use a non-oxidizing brazing material for brazing the parts and do not use flux. If not, oxidized film can cause clogging or damage to the compressor unit and flux can harm the copper piping or refrigerant oil.



WARNING

When installing and moving the air conditioner to another site, be sure to make recharge refrigerant after perfect evacuation.

- If a different refrigerant or air is mixed with the original refrigerant, the refrigerant cycle may malfunction and the unit may be damaged.
- After selecting diameter of the refrigerant pipe to suit total capacity of the indoor unit connected after branching, use an appropriate branch pipe set according to the pipe diameter of the indoor unit and the installation pipe drawing.

Pipe connections between indoor and outdoor unit

- Pipe connections can be done on the front side or on the side according to the installation environments.
- Be sure to let 2.8psi(0.2kgf/cm²) Nitrogen flow in the pipe when welding.
- If Nitrogen was not flown during welding, many oxidized membranes may form inside the pipe and disturb the normal operations of valves and condensers.

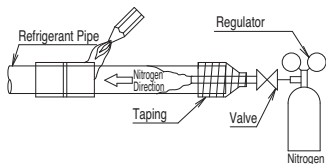
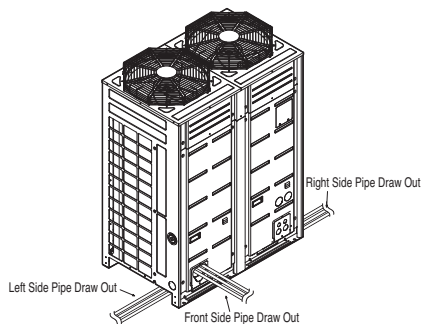

Preparation Work

- Use Knock Outs of Base Pan of the outdoor unit for Left/Right or Bottom pipe drawing outs.

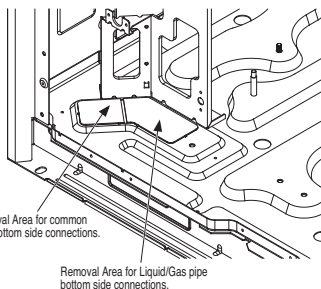

CAUTION

- Do not give damage to the pipe/base during the Knock Out work.
- Proceed to pipe work after removing burr after Knock Out work.
- Perform sleeve work to prevent damage to the wire when connecting wires using Knock Outs.

CAUTION

- Remove the brackets on the inverter condenser legs that were fixed to protect the unit during the transportation. (If bracket is not removed, abnormal noise or vibration may occur.)

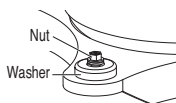
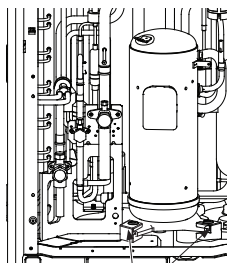

1. Open the front panel.
2. Remove Brackets
3. Fix with only nut and washer as shown in the figure.

■ Remove leakage prevention cap

- Remove the leakage prevention cap attached to the outdoor unit service valve before pipe work.
- Proceed the leakage prevention cap removal as follows:
 1. Verify whether the liquid/gas/common pipes are locked.
 2. Extract remaining refrigerant or air inside using the service port.
 3. Remove the leakage prevention cap

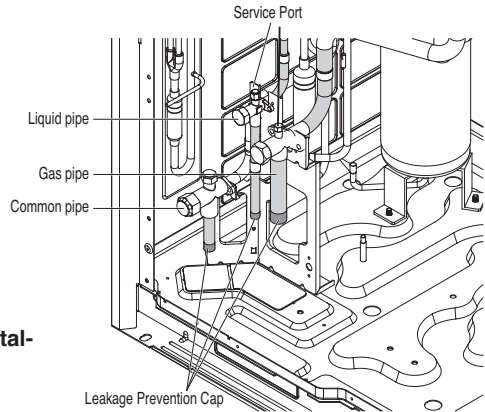

■ Method of pipe cap work during the installation of single outdoor unit

1. Remove rubber cap inserted in the common pipe.
2. Wrap the common pipe service valve with wet towel.
3. Insert the pipe cap provided into the common pipe.
4. Place high/low pressure flare nut cap under the pipe cap so that the pipe cap does not move.
5. Weld the pipe cap.
 - ✦ If not wrapped with a wet towel, there may be damages inside the valve.
 - ✦ If the unit is operated without pipe cap work, there may be abnormality in the cycle caused by refrigerant leakage.

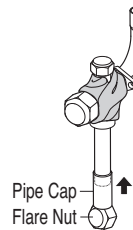

Pipe Drawing Out during Single / Series connection

■ Method of drawing out pipes on the front side

- Proceed with the pipe work as shown in the below figure for front side pipe drawing out.

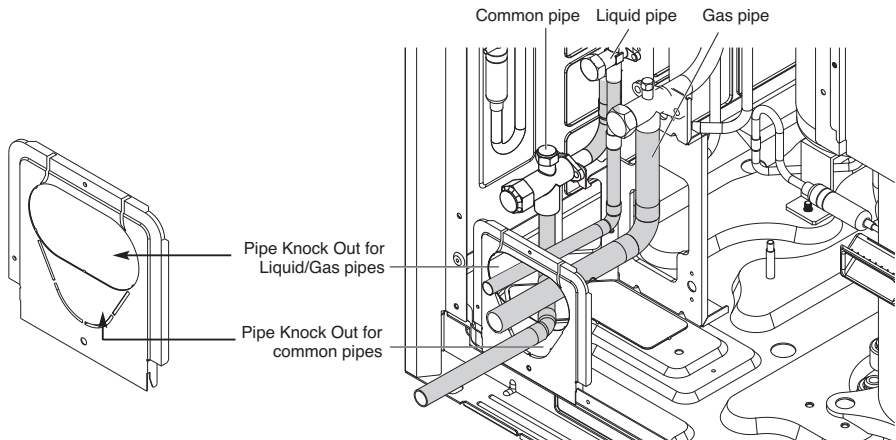

■ Method of drawing out pipes on the bottom side

① Drawing out common pipe through side panel

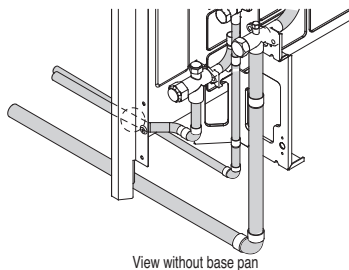
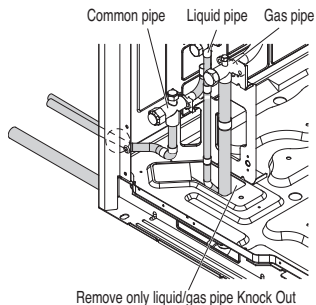

② Drawing out common pipe through bottom pipe

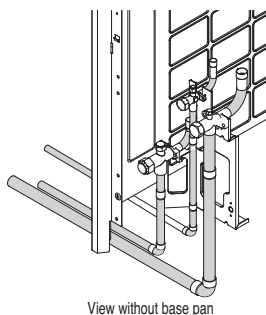
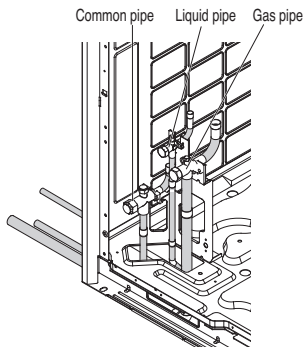

■ Figure of Sides when drawing out through bottom pipe

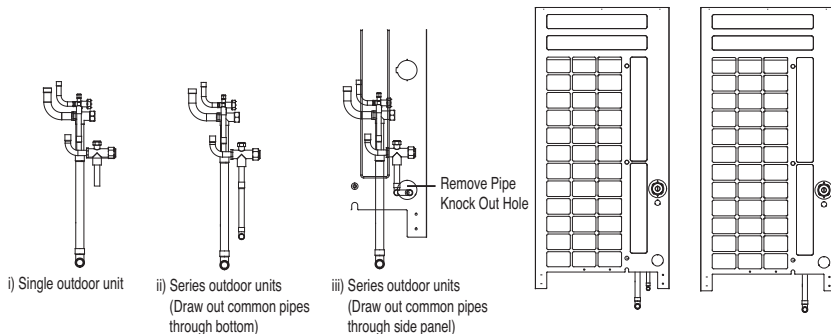

Refrigerant piping system

◆ Y branch method

1 Outdoor Units

Example : 5 Indoor Units connected

- Ⓐ : Outdoor Unit
- Ⓑ : 1st branch (Y branch)
- Ⓒ : Indoor Units

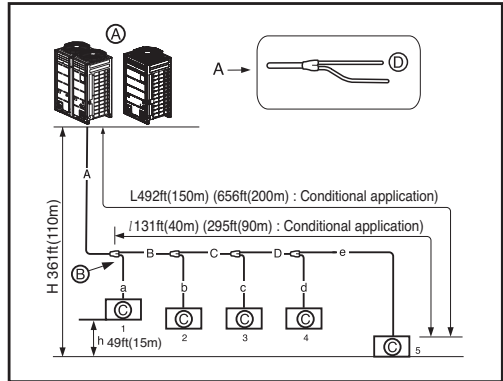

2 Outdoor Units

Example : 5 Indoor Units connected

- Ⓐ : Outdoor Unit
- Ⓑ : 1st branch (Y branch)
- Ⓒ : Indoor Units
- Ⓓ : Downward Indoor Unit
- Ⓔ : Connection branch pipe between Outdoor units: ARCNN21

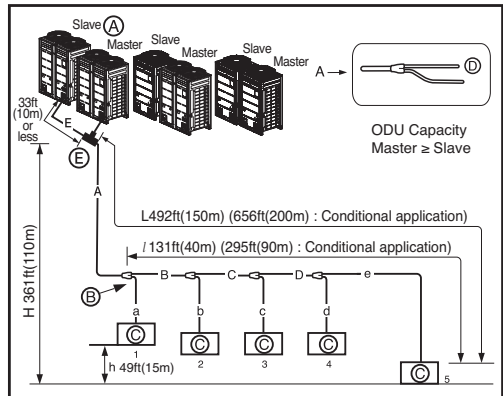

Piping length from outdoor branch to outdoor unit $\leq 33\text{ft}(10\text{m})$, equivalent length: max $43\text{ft}(13\text{m})$ (for 12ton(14HP) or more)

Additional Application

To satisfy below condition to make 131ft(40m) ~ 295ft(90m) of pipe length after first branch.

- 1) Diameter of pipes between first branch and the last branch should be increased by one step, except pipe diameter B,C,D is same as Diameter A

$\varnothing 1/4(6.35\text{mm}) \rightarrow \varnothing 3/8(9.52\text{mm}) \rightarrow \varnothing 1/2(12.7\text{mm}) \rightarrow \varnothing 5/8(15.88\text{mm}) \rightarrow \varnothing 3/4(19.05\text{mm}) \rightarrow \varnothing 7/8(22.2\text{mm}) \rightarrow \varnothing 1(25.4)^*$
 $\varnothing 1-1/8(28.58\text{mm}) \rightarrow \varnothing 1-1/4(31.8\text{mm})^* \rightarrow \varnothing 1-3/8(34.9\text{mm}) \rightarrow \varnothing 1-1/2(38.1\text{mm})^*$

* : It is not necessary to size up.

※ If the step up size is not available, you can not select the next higher size available.

- 2) While calculating whole refrigerant pipe length, pipe B,C,D length should be calculated twice.

$A+Bx2+Cx2+Dx2+a+b+c+d+e \leq 3281\text{ft}(1000\text{m})$

- 3) Length of pipe from each indoor unit to the closest branch (a,b,c,d,e) $\leq 131\text{ft}(40\text{m})$

- 4) [Length of pipe from outdoor unit to the farthest indoor unit 5 (A+B+C+D+e)]

- [Length of pipe from outdoor unit to the closest indoor unit 1 (A+a)] $\leq 131\text{ft}(40\text{m})$

3 Outdoor Units

Example : 5 Indoor Units connected

- (A) : Outdoor Unit
- (B) : 1st branch (Y branch)
- (C) : Indoor Units
- (D) : Downward Indoor Unit
- (E) : Connection branch pipe between Outdoor units: ARCNN31
- (F) : Connection branch pipe between Outdoor units: ARCNN21

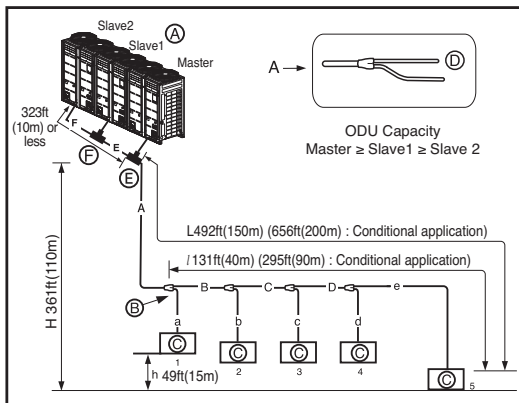

Piping length from outdoor branch to outdoor unit \leq 33ft(10m), equivalent length : max. 43ft(13m)(for 12ton(14HP) or more)

Additional Application

To satisfy below condition to make 131ft(40m) ~ 295ft(90m) of pipe length after first branch.

- 1) Diameter of pipes between first branch and the last branch should be increased by one step, except pipe diameter B,C,D is same as Diameter A

$\varnothing 1/4(6.35\text{mm}) \rightarrow \varnothing 3/8(9.52\text{mm}) \rightarrow \varnothing 1/2(12.7\text{mm}) \rightarrow \varnothing 5/8(15.88\text{mm}) \rightarrow \varnothing 3/4(19.05\text{mm}) \rightarrow \varnothing 7/8(22.2\text{mm}) \rightarrow \varnothing 1(25.4)^*$
 $\varnothing 1-1/8(28.58\text{mm}) \rightarrow \varnothing 1-1/4(31.8\text{mm})^*, \varnothing 1-3/8(34.9\text{mm}) \rightarrow \varnothing 1-1/2(38.1\text{mm})^*$

* : It is not necessary to size up.

* If the step up size is not available, you can not select the next higher size available.

- 2) While calculating whole refrigerant pipe length, pipe B,C,D length should be calculated twice.
 $A+Bx2+Cx2+Dx2+a+b+c+d+e \leq 3281\text{ft}(1000\text{m})$
- 3) Length of pipe from each indoor unit to the closest branch (a,b,c,d,e) \leq 131ft(40m)
- 4) [Length of pipe from outdoor unit to the farthest indoor unit 5 (A+B+C+D+e)]
 - [Length of pipe from outdoor unit to the closest indoor unit 1 (A+a)] \leq 131ft(40m)

▷ Refrigerant pipe diameter from branch to branch (B,C,D)

Downward Indoor Unit total capacity [kW(Btu/h)]	Liquid pipe [inch(mm)]	Gas pipe [inch(mm)]
≤ 5.6(19,100)	1/4(Ø6.35)	1/2(Ø12.7)
< 16.0(54,600)	3/8(Ø9.52)	5/8(Ø15.88)
≤ 22.4(76,400)	3/8(Ø9.52)	3/4(Ø19.05)
< 33.6(114,700)	3/8(Ø9.52)	7/8(Ø22.2)
< 50.4(172,000)	1/2(Ø12.7)	1 ¹ / ₈ (Ø28.58)
< 67.2(229,400)	5/8(Ø15.88)	1 ¹ / ₈ (Ø28.58)
< 72.8(248,500)	5/8(Ø15.88)	1 ³ / ₈ (Ø34.9)
< 100.8(344,000)	3/4(Ø19.05)	1 ³ / ₈ (Ø34.9)
< 173.6(592,500)	3/4(Ø19.05)	1 ⁵ / ₈ (Ø41.3)
< 184.8(630,700)	7/8(Ø22.2)	1 ³ / ₄ (Ø44.5)
< 224.0(764,400)	7/8(Ø22.2)	2(Ø53.98)

▷ Total pipe length = A+B+C+D+a+b+c+d+e ≤ 3281ft(1000m)

L	Longest pipe length	Equivalent pipe length
	A+B+C+D+e ≤ 492ft(656ft**(200m))	*A+B+C+D+e ≤ 574ft(656ft**(200m))
l	Longest pipe length after 1st branch	
	B+C+D+e ≤ 131ft**(40m)	
H	Difference in height(Outdoor Unit ↔ Indoor Unit)	
	H ≤ 361ft(110m)	
h	Difference in height (Indoor Unit ↔ Indoor Unit)	
	h ≤ 49ft(15m)	
h1	Difference in height (Outdoor Unit ↔ Outdoor Unit)	
	h1 ≤ 16.4ft(5m)	

- * : Assume equivalent piping length of Y branch to be 1.6ft(0.5m), that of header to be 3.3ft(1m), calculation purpose.
- ** : To apply Conditional Application



WARNING

If overall equivalent pipe length is greater than or equal to 295ft(90m) from ODU to the longest IDU, The diameter of the main pipe (Gas and Liquid pipes) must be increased as follow.

▷ Refrigerant pipe diameter from outdoor unit to first branch. (A)

Outdoor unit Total capacity [kW (Btu/h)]	Standard Pipe Diameter		Conditional application (more than 90m from ODU to IDU)	
	Liquid pipe [mm (inch)]	Gas pipe [mm (inch)]	Liquid pipe [mm (inch)]	Gas pipe [mm (inch)]
16.0~22.4(54,600~76,400) 28.0(95,900)	Φ9.52(3/8)	Φ19.05(3/4)	Φ12.7(1/2)	Φ22.2(7/8)
		Φ22.2(7/8)		Φ25.4(1)
33.6~44.8(172,000~152,900)	Φ12.7(1/2)	Φ28.58(1 1/8)	Φ15.88(5/8)	Φ28.58(1 1/8)
50.4~61.6(172,000~210,600) 67.2(229,400)				Φ15.88(5/8)
72.8~95.2(248,500~324,900)	Φ19.05(3/4)	Φ34.9(1 3/8)	Φ19.05(3/4)	Φ34.9(1 3/8)
100.8~168.0(344,000~573,300)				Φ19.05(3/4)
173.6~179.2(592,500~611,600)	Φ22.2(7/8)	Φ41.3(1 5/8)	Φ22.2(7/8)	Φ41.3(1 5/8)
184.8~224.0(630,700~764,400)		Φ44.5(1 3/4)		Φ25.4(1)
		Φ53.98(2)		

*: If the step up size is not available, you can not select the next higher size available.

◆ Header Method

1 Outdoor Unit

Example : 6 Indoor Units connected

- Ⓐ : Outdoor Unit
- Ⓑ : 1st branch
- Ⓒ : Indoor Units
- Ⓓ : Sealed piping

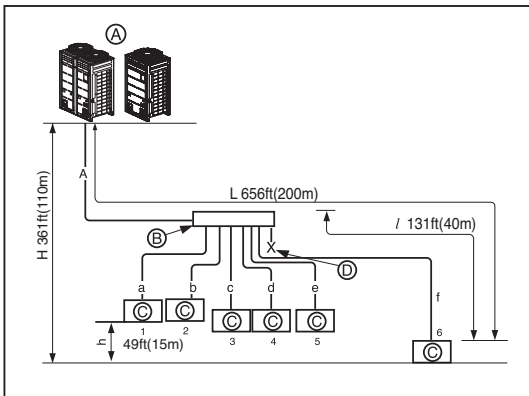

2 Outdoor Units

Example : 6 Indoor Units connected

- Ⓐ : Outdoor Unit
- Ⓑ : Header branch
- Ⓒ : Indoor Units
- Ⓓ : Sealing
- Ⓔ : Connection branch pipe between Outdoor units: ARCNN21

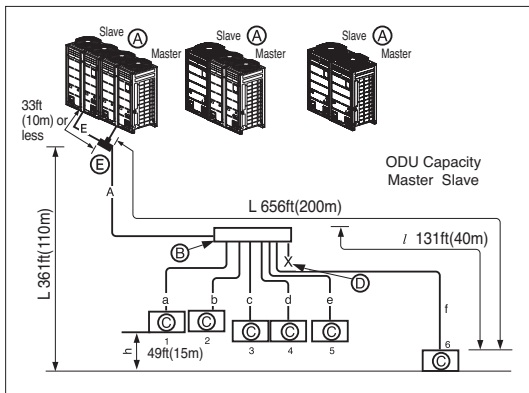

3 Outdoor Units

Example : 6 Indoor Units connected

- (A) : Outdoor Unit
- (B) : Header branch
- (C) : Indoor Units
- (D) : Sealing
- (E) : Connection branch pipe between Outdoor units: ARCNN31
- (F) : Connection branch pipe between Outdoor units: ARCNN21

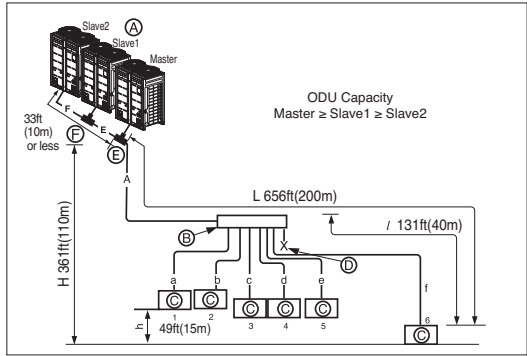

Branch pipe can not be used after header

∩ Total pipe length = A+a+b+c+d+e+f ≤ 3280.8ft(1000m)

L	Longest pipe length	* Equivalent pipe length
	A+f ≤ 656ft(200m)	A+f ≤ 738ft(225m)
l	Longest pipe length after 1st branch	
	f ≤ 131ft(40m)	
H	Difference in height (Outdoor Unit ↔ Indoor Unit)	
	H ≤ 361ft(110m)	
h	Difference in height (Indoor Unit ↔ Indoor Unit)	
	h ≤ 49ft(15m)	
h1	Difference in height (Outdoor Unit ↔ Outdoor Unit)	
	h1 ≤ 16ft(5m)	

⚠ WARNING

Pipe length after header branching (a~f)
It is recommended that difference in length of the pipes connected to the Indoor Units is minimized.
Performance difference between Indoor Units may occur.

- * * : Assume equivalent piping length of Y branch to be 1.6ft(0.5m), that of header to be 3.3ft(1m), calculation purpose
- It is recommended that indoor unit is installed at lower position than the header.
- Piping length from outdoor branch to outdoor unit ≤ 33ft(10m), equivalent length : max 43ft(13m) (for 12ton(14HP) or more)

⚠ WARNING

If overall equivalent pipe length is greater than or equal to 295ft(90m) from ODU to the longest IDU, The diameter of the main pipe (Gas and Liquid pipes) must be increased as follow.

∩ Refrigerant pipe diameter from outdoor unit to first branch. (A)

Outdoor unit Total capacity [kW (Btu/h)]	Standard Pipe Diameter		Conditional application (more than 90m from ODU to IDU)	
	Liquid pipe [mm (inch)]	Gas pipe [mm (inch)]	Liquid pipe [mm (inch)]	Gas pipe [mm (inch)]
16.0~22.4(54,600~76,400) 28.0(95,900)	Φ9.52(3/8)	Φ19.05(3/4)	Φ12.7(1/2)	Φ22.2(7/8)
		Φ22.2(7/8)		Φ25.4(1)
33.6~44.8(172,000~152,900)	Φ12.7(1/2)	Φ28.58(1 1/8)	Φ15.88(5/8)	Φ28.58(1 1/8)
50.4~61.6(172,000~210,600) 67.2(229,400)				Φ31.8(1 1/4)
72.8~95.2(248,500~324,900)	Φ15.88(5/8)	Φ34.9(1 3/8)	Φ19.05(3/4)	Φ34.9(1 3/8)
100.8~168.0(344,000~573,300)				Φ38.1(1 1/2)
173.6~179.2(592,500~611,600)	Φ19.05(3/4)	Φ41.3(1 5/8)	Φ22.2(7/8)	Φ41.3(1 5/8)
184.8~224.0(630,700~764,400)		Φ44.5(1 3/4)		Φ25.4(1)
	Φ22.2(7/8)	Φ53.98(2)		

* If the step up size is not available, you can not select the next higher size available.

◆ Combination of Y branch/header method

1 Outdoor Units

Example : 5 Indoor Units connected

- Ⓐ : Outdoor Unit
- Ⓑ : 1st branch (Y branch)
- Ⓒ : Y branch
- Ⓓ : Indoor Unit
- Ⓔ : Header
- Ⓕ : Sealed piping

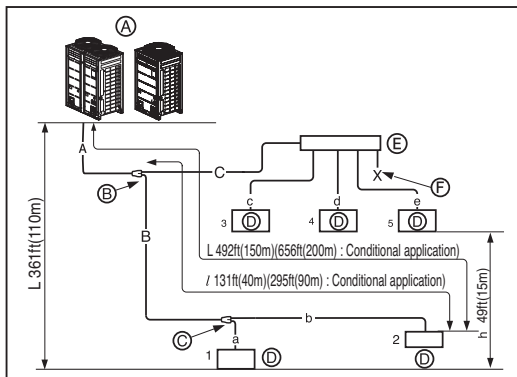

Branch pipe can not be used after header

2 Outdoor Units

Example : 5 Indoor Units connected

- Ⓐ : Outdoor Unit
- Ⓑ : 1st branch
- Ⓒ : Y branch
- Ⓓ : Indoor Unit
- Ⓔ : Connection branch pipe between Outdoor units: ARCNN21
- Ⓕ : Header
- Ⓖ : Sealed piping

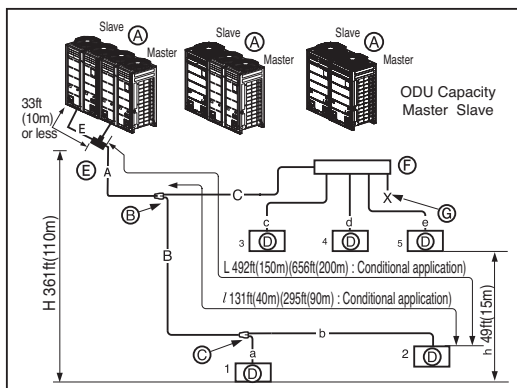

Branch pipe can not be used after header

3 Outdoor Units

Example : 5 Indoor Units connected

- (A) : Outdoor Unit
- (B) : 1st branch(Y branch)
- (C) : Y branch
- (D) : Indoor Unit
- (E) : Connection branch pipe between Outdoor units:
ARCNN31
- (F) : Connection branch pipe between Outdoor units:
ARCNN21
- (G) : Header
- (H) : Sealing

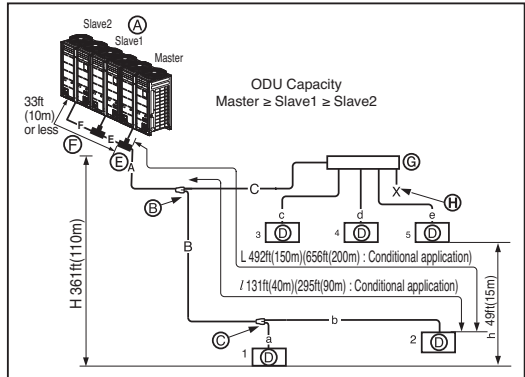

Branch pipe can not be used after header

▷ Refrigerant pipe diameter from branch to branch (B,C)

Downward Indoor Unit total capacity [kW(Btu/h)]	Liquid pipe [inch(mm)]	Gas pipe [inch(mm)]
≤ 5.6(19,100)	Ø6.35(1/4)	Ø12.7(1/2)
< 16.0(54,600)	Ø9.52(3/8)	Ø15.88(5/8)
≤ 22.4(76,400)	Ø9.52(3/8)	Ø19.05(3/4)
< 33.6(114,700)	Ø9.52(3/8)	Ø22.2(7/8)
< 50.4(172,000)	Ø12.7(1/2)	Ø28.58(1 1/8)
< 67.2(229,400)	Ø15.88(5/8)	Ø28.58(1 1/8)
< 72.8(248,500)	Ø15.88(5/8)	Ø34.9(1 3/8)
< 100.8(344,000)	Ø19.05(3/4)	Ø34.9(1 3/8)
< 173.6(592,500)	Ø19.05(3/4)	Ø41.3(1 5/8)
< 184.8(630,700)	Ø22.2(7/8)	Ø44.5(1 5/8)
< 224.0(764,400)	Ø22.2(7/8)	Ø53.98(2)

▷ Total pipe length = A+B+C+a+b+c+d+e ≤ 3280.8ft(1000m)

L	Longest pipe length	* Equivalent pipe length
	A+B+b ≤ 492ft(656ft(200m)**)	A+B+b ≤ 574ft(738ft(225m)**)
l	Longest pipe length after 1st branch	
	B+b ≤ 131ft(40m)(295ft(90m)**)	
H	Difference in height(Outdoor Unit ↔ Indoor Unit)	
	H ≤ 361ft(110m)	
h	Difference in height (Indoor Unit ↔ Indoor Unit)	
	h ≤ 49ft(15m)	
h1	Difference in height (Outdoor Unit ↔ Outdoor Unit)	
	h1 ≤ 16ft(5m)	

- * : Assume equivalent pipe length of Y branch to be 1.6ft(0.5m), that of header to be 3.3ft(1m), calculation purpose
- It is recommended that indoor unit is installed at lower position than the header.



WARNING

If overall equivalent pipe length is greater than or equal to 295ft(90m) from ODU to the longest IDU, The diameter of the main pipe (Gas and Liquid pipes) must be increased as follow.

▷ Refrigerant pipe diameter from outdoor unit to first branch. (A)

Outdoor unit Total capacity [kW (Btu/h)]	Standard Pipe Diameter		Conditional application (more than 90m from ODU to IDU)	
	Liquid pipe [mm (inch)]	Gas pipe [mm (inch)]	Liquid pipe [mm (inch)]	Gas pipe [mm (inch)]
16.0~22.4(54,600~76,400)	Ø9.52(3/8)	Ø19.05(3/4)	Ø12.7(1/2)	Ø22.2(7/8)
28.0(95,900)		Ø22.2(7/8)		Ø25.4(1)
33.6~44.8(172,000~152,900)	Ø12.7(1/2)	Ø28.58(1 1/8)	Ø15.88(5/8)	Ø28.58(1 1/8)
50.4~61.6(172,000~210,600)	Ø15.88(5/8)		Ø34.9(1 3/8)	Ø19.05(3/4)
67.2(229,400)		Ø19.05(3/4)	Ø41.3(1 5/8)	Ø22.2(7/8)
72.8~95.2(248,500~324,900)	Ø22.2(7/8)	Ø44.5(1 3/4)		
100.8~168.0(344,000~573,300)		Ø15.88(5/8)	Ø53.98(2)	Ø41.3(1 5/8)
173.6~179.2(592,500~611,600)	Ø22.2(7/8)	Ø53.98(2)	Ø25.4(1)	Ø53.98(2)
184.8~224.0(630,700~764,400)				

* If available on site, it use this size. Otherwise it can't be increased.

◆ Outdoor unit Connection



WARNING

• In case of pipe diameter B connected after first branch is bigger than the main pipe diameter A, B should be of the same size with A.

Ex) In case indoor unit combination ratio 120% is connected to 70kW outdoor unit.

1) Outdoor unit main pipe diameter A : Ø34.9(1-3/8, gas pipe), Ø15.88(5/8, liquid pipe)

2) Pipe diameter B after first branch according to 120% indoor unit combination(84kW) : Ø34.9(1-3/8, gas pipe), Ø19.05(3/4, liquid pipe)

Therefore, pipe diameter B connected after first branch would be Ø34.9(1-3/8, gas pipe) / Ø15.88(5/8, liquid pipe) which is same with main pipe diameter.

[Example]

Instead of using indoor unit total capacity, use outdoor unit model name in order to choose main pipe diameter by downward.

Do not let the connection pipe from branch to branch exceed the main pipe diameter chosen by outdoor unit model name.

EX) Where connecting the indoor units to the 22 HP (61.6kW) outdoor unit to 120% of its system capacity (73.8 kW) and branching 7k Btu/h(2.2kW) indoor unit at the 1st branch

Main pipe diameter(22 HP outdoor unit): Ø28.58(1-1/8, Gas pipe) Ø15.88(5/8, Liquid pipe)

Pipe diameter between 1st and 2nd branch (71.7kW indoor units):

Ø34.9(1-3/8, Gas pipe) Ø19.05(3/4, Liquid pipe) in conformity with downward indoor units.

Since the main pipe diameter of 22HP outdoor unit is Ø28.58(1-1/8, Gas pipe) and Ø15.88(5/8, Liquid pipe), Ø28.58 (1-1/8, Gas pipe) and Ø15.88(5/8, Liquid pipe) is used as the main pipe and the connection pipe between 1st and 2nd branch.

* High/Low Pressure Common Pipe: Ø19.05(3/4) ; 14HP or more

◆ Indoor Unit Connection

▷ Indoor Unit connecting pipe from branch (a,b,c,d,e,f)

Indoor Unit capacity [kW(Btu/h)]	Liquid pipe [mm(inch)]	Gas pipe [mm(inch)]
≤ 5.6(19,100)	Ø6.35(1/4)	Ø12.7(1/2)
< 16.0(54,600)	Ø9.52(3/8)	Ø15.88(5/8)
≤ 22.4(76,400)	Ø9.52(3/8)	Ø19.05(3/4)

* ARNU093TN*2, ARNU123TN*2, ARNU153TN*2, ARNU183TM*2, ARNU243TM*2 : Liquid pipe Ø9.52(3/8), Gas pipe Ø15.88(5/8)

ARNU153BG*2, ARNU183BG*2, ARNU243BG*2 : Liquid pipe Ø9.52(3/8), Gas pipe Ø15.88(5/8)

◆ Pipe Connection Method/Precautions for Series connections between Outdoor units

- Separate Y branch joints are needed for series connections between outdoor units.
- Please refer to the below connection examples to install pipe connections between outdoor units.

■ Pipe connection between outdoor units (General Case)

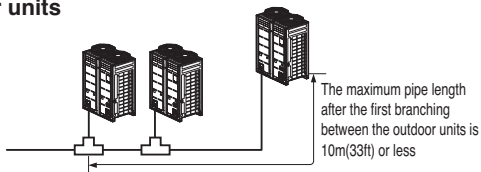

■ Pipes between outdoor units are 2m(6.6ft) or less

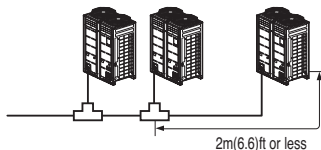

■ Pipes between outdoor units are 2m(6.6ft) or longer

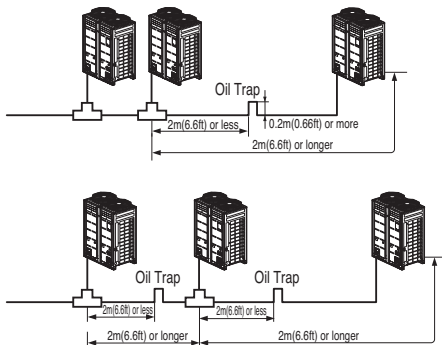

- If the distance between the outdoor units becomes more than 2m(6.6ft), apply Oil Traps between the gas pipes.
- If the outdoor unit is located lower than the main pipe, apply Oil Trap.

■ Examples of Wrong Pipe Connections

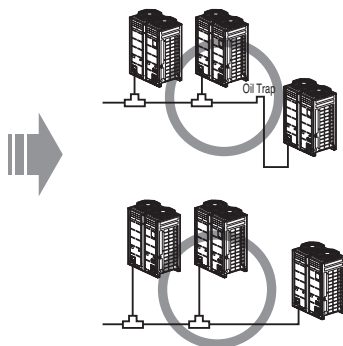
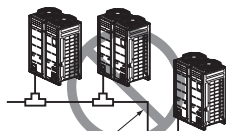
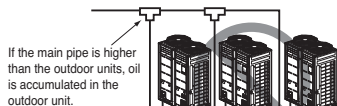

Pipe connections between indoor and outdoor unit

- The pipes between the outdoor units must maintain level or give an inclination to prevent a back flow toward the slave outdoor unit. Otherwise, the unit may not operate properly.

(Example 1)

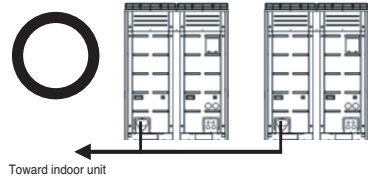
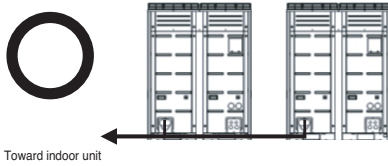

(Example 2)

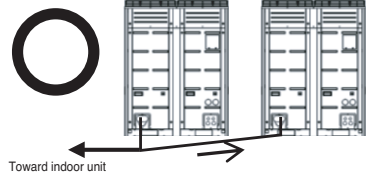
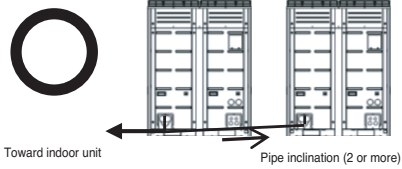

(Example 3)

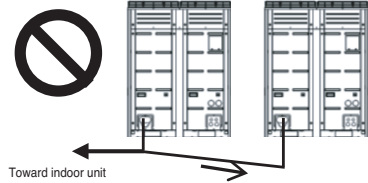
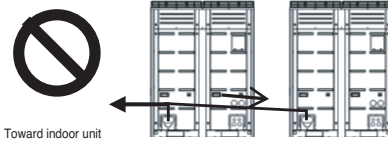

- Apply Oil Trap only to gas pipe as shown below when the length of the pipe between the outdoor units is over 2m(6.6ft). Otherwise, the unit may not operate properly.

(Example 1)

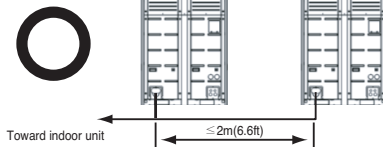

(Example 2)

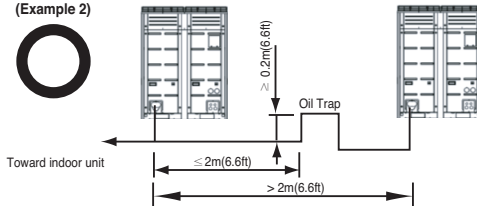

- * Install oil trap if the ODU is at lower level than main piping.

- When connecting the pipes between the outdoor units, the accumulation of oil in the slave outdoor unit should be avoided. Otherwise, the unit may not operate properly.

(Example 1)

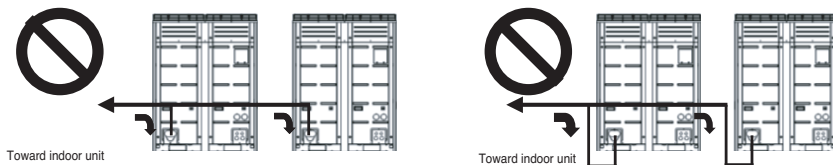

(Example 2)

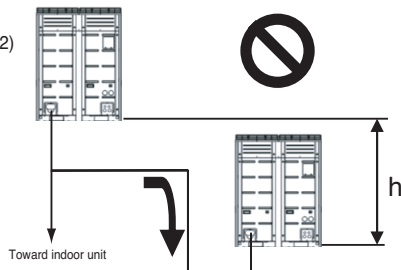

(Example 3)

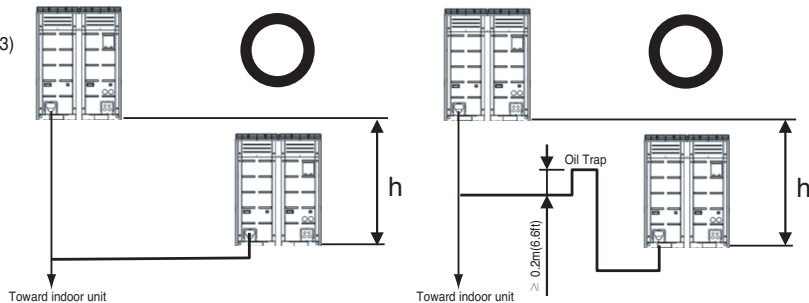

* The level difference between two outdoor units, h is allowed up to 5m(16.4ft).

◆ The amount of Refrigerant

The calculation of the additional charge should take into account the length of pipe and CF(correction Factor) value of indoor unit.

Additional charge(kg)	=	Total liquid pipe :Ø25.4 mm (1.0 inch)	x	0.323(lbs/ft)
	+	Total liquid pipe :Ø22.2 mm (7/8 inch)	x	0.238(lbs/ft)
	+	Total liquid pipe :Ø19.05 mm (3/4 inch)	x	0.179(lbs/ft)
	+	Total liquid pipe :Ø15.88 mm (5/8 inch)	x	0.116(lbs/ft)
	+	Total liquid pipe :Ø12.7 mm (1/2 inch)	x	0.079(lbs/ft)
	+	Total liquid pipe :Ø9.52 mm (3/8 inch)	x	0.041(lbs/ft)
	+	Total liquid pipe :Ø6.35 mm(1/4 inch)	x	0.015(lbs/ft)
	+	CF value of indoor unit		

CF value of indoor unit

(Unit: lbs)

Capacity(Btu/h(kW))	5k	7k	9k	12k	15k	18k	24k	28k	36k	42k	48k	76k	96k
Ceiling Concealed Duct (Low Static)	-	0.37	0.37	0.37	0.37	0.82	0.82	-	-	-	-	-	-
Ceiling Concealed Duct (High Static)	-	0.57	0.57	0.57	0.57	0.57	0.57	0.97	0.97	0.97	1.37	2.20	2.20
Wall Mounted	-	0.53	0.53	0.53	0.53	0.62	0.62	-	-	-	-	-	-
1Way Ceiling Cassette	-	0.44	0.44	0.44	-	0.64	0.64	-	-	-	-	-	-
2Way Ceiling Cassette	-	-	-	-	-	0.35	0.35	-	-	-	-	-	-
4Way Ceiling Cassette	0.40	0.40	0.55	0.55	0.71	0.71	1.06	1.06	1.41	1.41	1.41	-	-
ARTCOOL Gallery	-	0.22	0.22	0.22	-	-	-	-	-	-	-	-	-
Floor Standing	-	0.37	0.37	0.37	0.37	0.82	0.82	-	-	-	-	-	-
Ceiling & Floor	-	-	0.22	0.22	-	-	-	-	-	-	-	-	-
Ceiling Suspended	-	0.77	0.77	-	1.19	-	1.65	-	-	-	-	-	-
Console	-	0.37	0.37	0.37	0.37	-	-	-	-	-	-	-	-
Fresh Air Intake Unit	-	-	-	-	-	-	-	-	-	-	1.37	2.20	2.20
Heat recovery ventilator(DX)	-	-	-	0.44	-	0.44	0.44	-	-	-	-	-	-
Hydro kit	-	-	-	-	-	-	-	-	-	-	-	-	3.53
Vertical AHU	-	-	-	-	-	1.04	1.04	-	1.57	2.00	2.00	2.00	2.00



CAUTION

Use only 2-series of indoor unit. Ex) ARNU****2

: Use only ARNU153BGA2, ARNU183BGA2, ARNU243BGA2

##: Use only ARNU093TN*2, ARNU123TN*2, ARNU153TN*2, ARNU183TM*2, ARNU243TM*2

! WARNING

- ▶ Regulation for refrigerant leakage
 - : the amount of refrigerant leakage should satisfy the following equation for human safety.

$$\frac{\text{Total amount of refrigerant in the system}}{\text{Volume of the room at which Indoor Unit of the least capacity is installed}} \leq 0.44(\text{kg/m}^3)(0.028(\text{lbs/ft}^3))$$

☐ If the above equation can not be satisfied, then follow the following steps.

- Selection of air conditioning system: select one of the next
 1. Installation of effective opening part
 2. Reconfirmation of Outdoor Unit capacity and piping length
 3. Reduction of the amount of refrigerant
 4. Installation of 2 or more security device (alarm for gas leakage)
- Change Indoor Unit type
 - : installation position should be over 6.6ft from the floor (Wall mounted type → Cassette type)
- Adoption of ventilation system
 - : choose ordinary ventilation system or building ventilation system
- Limitation in piping work
 - : Prepare for earthquake and thermal stress

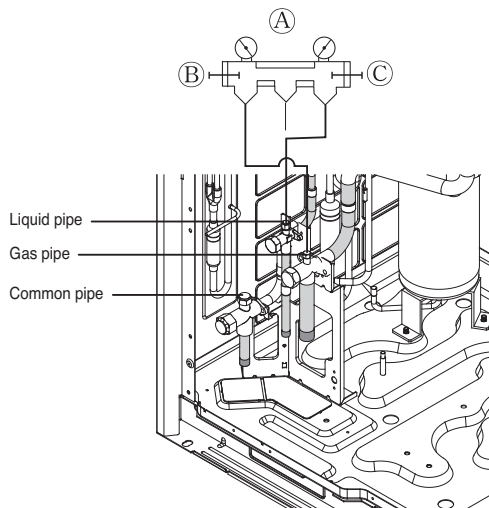
Refrigerant Charging

- Ⓐ Manifold Gauge
- Ⓑ Low pressure side Handle
- Ⓒ High pressure side Handle

- Add exact amount of refrigerant calculated by the installation pipe diameter length and the indoor combination.
- If the refrigerant amount is not exact, it may not operate properly.
- If additionally bottled refrigerant amount is over $\pm 10\%$, condenser burning or insufficient indoor unit performance may be caused.

! WARNING

- Pipe to be vacuumed : gas pipe, water pipe, common pipe
- If the refrigerant amount is not exact, it may not operate properly.
- If additionally bottled refrigerant amount is over $\pm 10\%$, condenser burning or insufficient indoor unit performance may be caused.

Distribution Method

1. Line Distribution

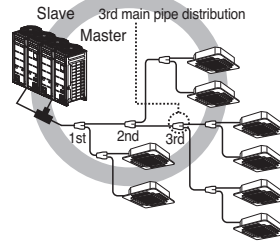
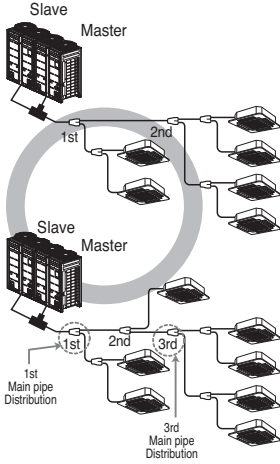

2. Vertical Distribution

Ensure that the branch pipes are attached vertically.

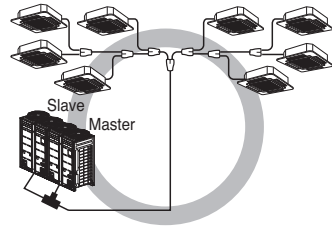
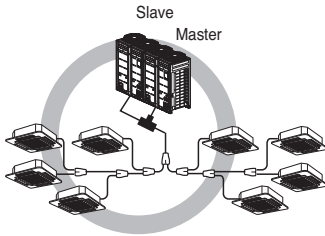

3. The others

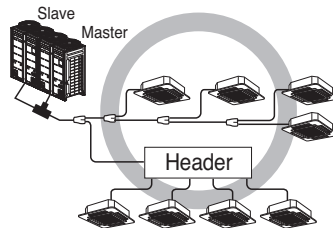
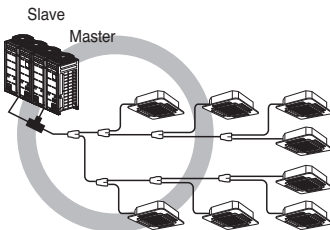

Branch pipe Fitting

■ Y branch

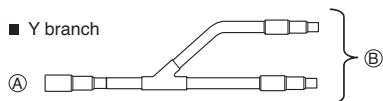

- Ⓐ To Outdoor Unit
- Ⓑ To Branch Piping or Indoor Unit

- Ensure that the branch pipes are attached horizontally or vertically (see the diagram below.)

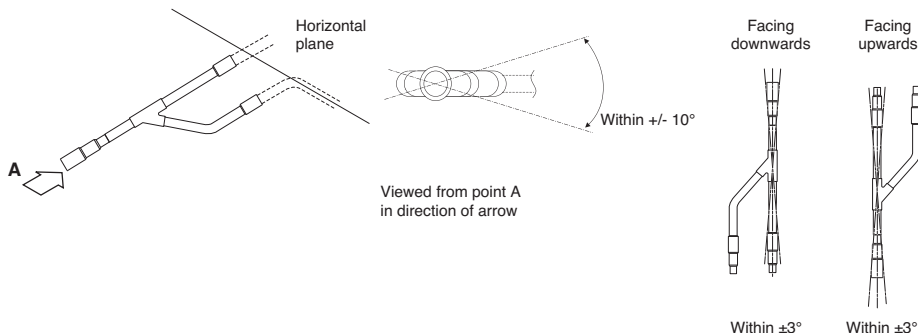

- There is no limitation on the joint mounting configuration.
- If the diameter of the refrigerant piping selected by the procedures described is different from the size of the joint, the connecting section should be cut with a pipe cutter.
- Branch pipe should be insulated with the insulator in each kit.

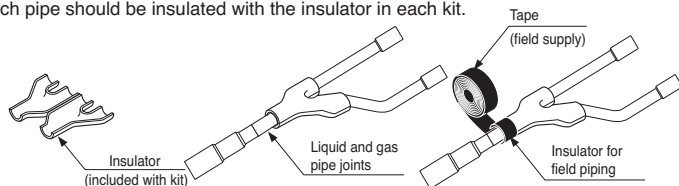

■ Header

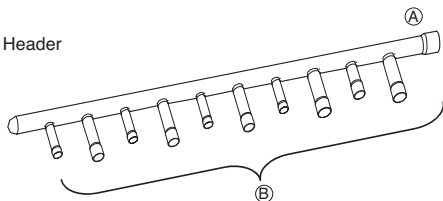

- Ⓐ To outdoor unit
- Ⓑ To indoor unit
- The indoor unit having larger capacity must be installed closer to Ⓐ than smaller one.
- If the diameter of the refrigerant piping selected by the procedures described is different from the size of the joint, the connecting section should be cut with a pipe cutter.

Ⓒ Pipe cutter

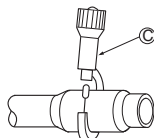

- When the number of pipes to be connected is smaller than the number of header branches, install a cap to the unconnected branches.

- When the number of indoor units to be connected to the branch pipes is less than the number of branch pipes available for connection then cap pipes should be fitted to the surplus branches.

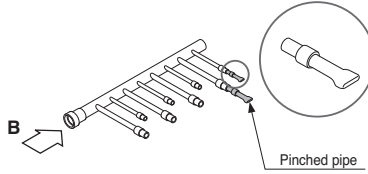

- Fit branch pipe lie in a horizontal plane.

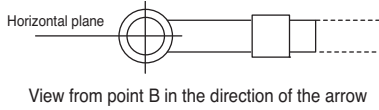

- Header should be insulated with the insulator in each kit.

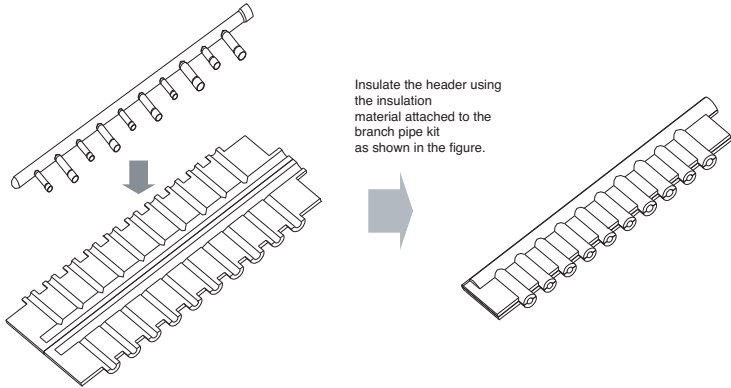

- Joints between branch and pipe should be sealed with the tape included in each kit.

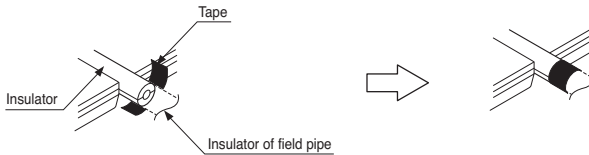

- Any cap pipe should be insulated using the insulator provided with each kit and then taped as described above.

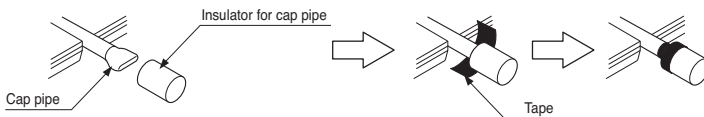

◆ Y branch pipe

[Unit:mm(inch)]

Models	Gas pipe	Liquid pipe
ARBLN01621	<p>Diagram showing a Y-branch gas pipe configuration. The main horizontal pipe has a diameter of $\phi 15.88(5/8)$. The branch pipe has a diameter of $\phi 12.7(1/2)$. The main pipe length is 281(11-1/16) mm, and the total length including the branch is 292(11-1/2) mm. The vertical distance from the main pipe to the branch is 74(2-9/32) mm. Detailed views of the pipe ends are provided: $\phi 19.05(3/4)$ with length 70(2-3/4) mm, and $\phi 15.88(5/8)$.</p>	<p>Diagram showing a Y-branch liquid pipe configuration. The main horizontal pipe has a diameter of $\phi 6.35(1/4)$. The branch pipe has a diameter of $\phi 9.52(3/8)$. The main pipe length is 281(11-1/16) mm, and the total length including the branch is 292(11-1/2) mm. The vertical distance from the main pipe to the branch is 74(2-9/32) mm. Detailed views of the pipe ends are provided: $\phi 12.7(1/2)$ with length 70(2-3/4) mm, and $\phi 9.52(3/8)$.</p>
ARBLN03321	<p>Diagram showing a Y-branch gas pipe configuration. The main horizontal pipe has a diameter of $\phi 15.88(5/8)$. The branch pipe has a diameter of $\phi 19.05(3/4)$. The main pipe length is 390(15-11/32) mm, and the total length including the branch is 413(16-1/4) mm. The vertical distance from the main pipe to the branch is 83(3-9/32) mm. Detailed views of the pipe ends are provided: $\phi 19.05(3/4)$ with length 70(2-3/4) mm, $\phi 25.4(1)$ with length 90(3-5/32) mm, $\phi 19.05(3/4)$ with length 110(4-11/32) mm, and $\phi 25.4(1)$.</p>	<p>Diagram showing a Y-branch liquid pipe configuration. The main horizontal pipe has a diameter of $\phi 6.35(1/4)$. The branch pipe has a diameter of $\phi 9.52(3/8)$. The main pipe length is 321(12-5/8) mm, and the total length including the branch is 332(13-1/16) mm. The vertical distance from the main pipe to the branch is 74(2-9/32) mm. Detailed views of the pipe ends are provided: $\phi 12.7(1/2)$ with length 110(4-11/32) mm, and $\phi 9.52(3/8)$ with length 70(2-3/4) mm.</p>
ARBLN07121	<p>Diagram showing a Y-branch gas pipe configuration. The main horizontal pipe has a diameter of $\phi 15.88(5/8)$. The branch pipe has a diameter of $\phi 19.05(3/4)$. The main pipe length is 376(14-13/16) mm, and the total length including the branch is 404(15-23/32) mm. The vertical distance from the main pipe to the branch is 96(3-25/32) mm. Detailed views of the pipe ends are provided: $\phi 22.2(7/8)$ with length 120(4-23/32) mm, $\phi 31.8(1-1/4)$ with length 90(3-17/32) mm, $\phi 19.05(3/4)$ with length 120(4-23/32) mm, and $\phi 28.58(1-1/8)$.</p>	<p>Diagram showing a Y-branch liquid pipe configuration. The main horizontal pipe has a diameter of $\phi 15.88(5/8)$. The branch pipe has a diameter of $\phi 19.05(3/4)$. The main pipe length is 371(14-19/32) mm, and the total length including the branch is 394(15-1/2) mm. The vertical distance from the main pipe to the branch is 83(3-9/32) mm. Detailed views of the pipe ends are provided: $\phi 12.7(1/2)$ with length 110(4-11/32) mm, and $\phi 9.52(3/8)$ with length 70(2-3/4) mm.</p>
ARBLN14521	<p>Diagram showing a Y-branch gas pipe configuration. The main horizontal pipe has a diameter of $\phi 15.88(5/8)$. The branch pipe has a diameter of $\phi 19.05(3/4)$. The main pipe length is 471(18-17/32) mm, and the total length including the branch is 517(20-11/32) mm. The vertical distance from the main pipe to the branch is 125(4-29/32) mm. Detailed views of the pipe ends are provided: $\phi 19.05(3/4)$ with length 120(4-23/32) mm, $\phi 22.2(7/8)$ with length 90(3-17/32) mm, $\phi 38.1(1-1/2)$ with length 130(5-1/8) mm, $\phi 41.3(1-5/8)$ with length 120(4-23/32) mm, $\phi 12.7(1/2)$ with length 70(2-3/4) mm, $\phi 28.58(1-1/8)$ with length 120(4-23/32) mm, and $\phi 19.05(3/4)$.</p>	<p>Diagram showing a Y-branch liquid pipe configuration. The main horizontal pipe has a diameter of $\phi 15.88(5/8)$. The branch pipe has a diameter of $\phi 19.05(3/4)$. The main pipe length is 416(16-3/8) mm, and the total length including the branch is 441(17-15/32) mm. The vertical distance from the main pipe to the branch is 96(3-25/32) mm. Detailed views of the pipe ends are provided: $\phi 12.7(1/2)$ with length 110(4-11/32) mm, $\phi 19.05(3/4)$ with length 90(3-5/32) mm, $\phi 22.2(7/8)$ with length 110(4-11/32) mm, and $\phi 9.52(3/8)$ with length 70(2-3/4) mm.</p>

◆ Header

[Unit:mm(inch)]

Models	Gas pipe	Liquid pipe
4 branch ARBL054		
7 branch ARBL057		
4 branch ARBL104		
7 branch ARBL107		
10 branch ARBL1010		
10 branch ARBL2010		

Leak Test and Vacuum drying

(1) Leak test

Leak test should be made by pressurizing nitrogen gas to 3.8Mpa(551.1psi). If the pressure does not drop for 24 hours, the system passes the test. If the pressure drops, check where the nitrogen leaks. For the test method, refer to the following figure. (Make a test with the service valves closed. Be also sure to pressurize liquid pipe, gas pipe and high/low pressure common pipe)

The test result can be judged good if the pressure has not be reduced after leaving for about one day after completion of nitrogen gas pressurization.

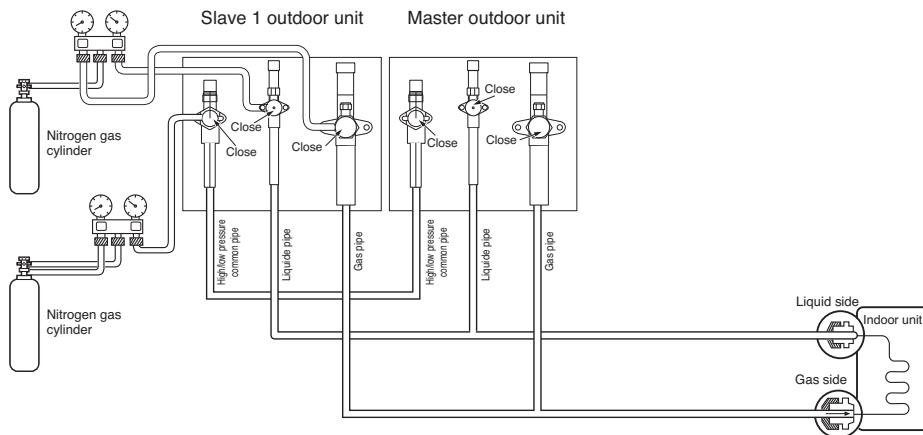

Note:

If the ambient temperature differs between the time when pressure is applied and when the pressure drop is checked, apply the following correction factor

There is a pressure change of approximately 0.01Mpa(1.5psi) for each 1°C of temperature difference.

Correction= (Temp. at the time of pressurization – Temp. at the time of check) X 0.1

For example: Temperature at the time of pressurization 3.8MPa(551psi) is 27 °C

24 hour later: 3.73MPa(541psi), 20°C

In this case the pressure drop of 0.07MPa(10psi) is because of temperature drop

And hence there is no leakage in pipe occurred.

Caution:

To prevent the nitrogen from entering the refrigeration system in the liquid state, the top of the cylinder must be at higher position than the bottom when you pressurize the system.

Usually the cylinder is used in a vertical standing position.

(2) Vacuum

Vacuum drying should be made from the service port provided on the outdoor unit's service valve to the vacuum pump commonly used for liquid pipe, gas pipe and high/low pressure common pipe. (Make Vacuum from liquid pipe, gas pipe and high/low pressure common pipe with the service valve closed.)

* Never perform air purging using refrigerant.

• Vacuum drying: Use a vacuum pump that can evacuate to -100.7kPa (-14.6psi , 5Torr , -755mmHg).

1. Evacuate the system from the liquid and gas pipes with a vacuum pump for over 2 hrs and bring the system to -100.7kPa (-14.6psi).

After maintaining system under that condition for over 1 hr, confirm the vacuum gauge rises. The system may contain moisture or leak.

2. Following should be executed if there is a possibility of moisture remaining inside the pipe.

(Rainwater may enter the pipe during work in the rainy season or over a long period of time)

After evacuating the system for 2 hrs, give pressure to the system to 0.05MPa (7.3psi) (vacuum break) with nitrogen gas and then evacuate it again with the vacuum pump for 1hr to -100.7kPa (-14.6psi) (vacuum break and its drying). If the system cannot be evacuated to -100.7kPa (-14.6psi) within 2 hrs, repeat the steps of vacuum break and its drying.

Finally, check if the vacuum gauge does not rise or not, after maintaining the system in vacuum for 1 hr.

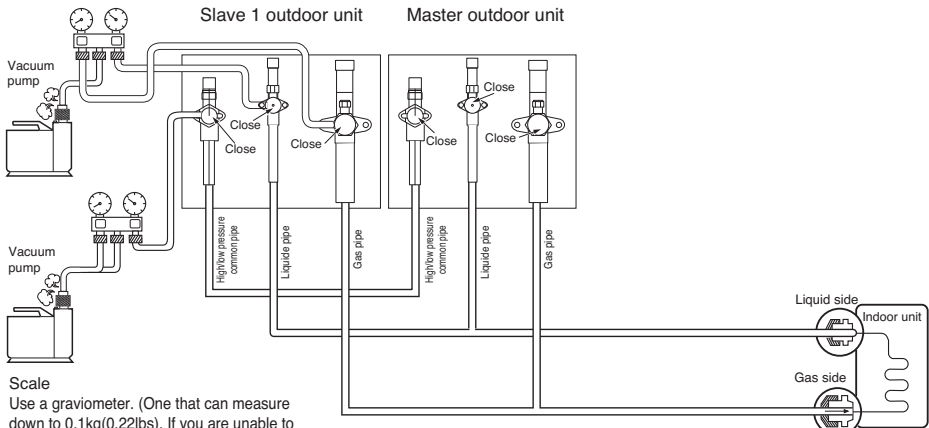

Scale

Use a gravimeter. (One that can measure down to 0.1kg (0.22lbs)). If you are unable to prepare such a high-precision gravimeter you may use a charge cylinder.

Note : Always add an appropriate amount of refrigerant. (For the refrigerant additional charge)

Too much or too little refrigerant will cause trouble.

To use the Vacuum Mode

(If the Vacuum mode is set, all valves of Indoor units and Outdoor units will be opened.)



WARNING

When Installing or moving the air conditioner to another site, recharge after perfect evacuation.

- If a different refrigerant or air is mixed with the original refrigerant, the refrigerant cycle may malfunction and the unit may be damaged.

Vacuum Mode

This function is used for creating vacuum in the system after compressor replacement, ODU parts replacement or IDU addition/replacement.

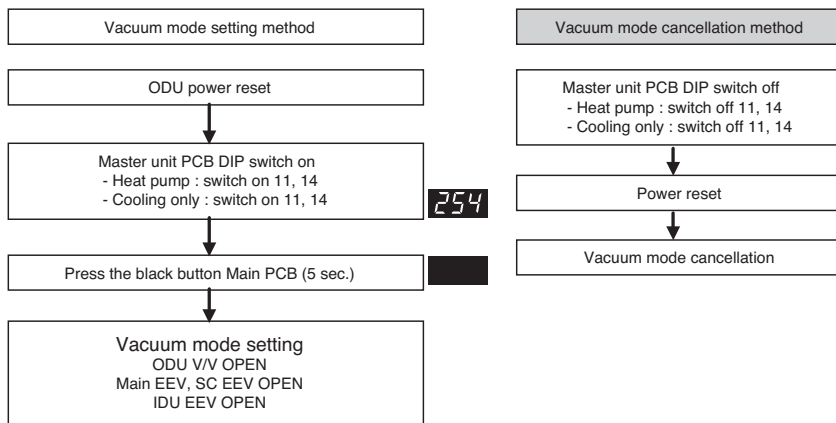

DIP Switch Settings

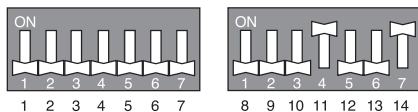

Warning : Please reset Main PCB before starting this function



CAUTION

ODU operation stops during vacuum mode. Compressor can't operate.

Thermal insulation of refrigerant piping

Be sure to give insulation work to refrigerant piping by covering liquid pipe and gas pipe separately with enough thickness heat-resistant polyethylene, so that no gap is observed in the joint between indoor unit and insulating material, and insulating materials themselves. When insulation work is insufficient, there is a possibility of condensation drip, etc. Pay special attention to insulation work to ceiling plenum.

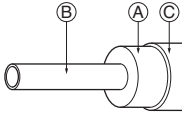

- (A) Heat insulation material
- (B) Pipe
- (C) Outer covering
(Wind the connection part and cutting part of heat insulation material with a finishing tape.)

Heat insulation material	Adhesive + Heat - resistant polyethylene foam + Adhesive tape	
	Indoor	Vinyl tape
Outer covering	Floor exposed	Water-proof hemp cloth + Bronze asphalt
	Outdoor	Water-proof hemp cloth + Zinc plate + Oily paint

Note:
When using polyethylene cover as covering material, asphalt roofing shall not be required.

Bad example	<ul style="list-style-type: none"> Do not insulate gas or low pressure pipe and liquid or high pressure pipe together. <ul style="list-style-type: none"> (A) Liquid pipe (B) Gas pipe (C) Power lines (D) Finishing tape (E) Insulating material (F) Transmission lines 	<ul style="list-style-type: none"> Be sure to fully insulate connecting portion. <p>(A) These parts are not insulated.</p>
	<ul style="list-style-type: none"> Good example <ul style="list-style-type: none"> (A) Liquid pipe (B) Gas pipe (C) Power lines (D) Insulating material (E) Transmission lines <p>Power lines Transmission lines</p> <p>Separation</p>	

Penetrations

Inner wall (concealed)

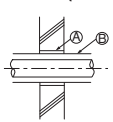

Outer wall

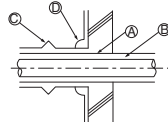

Outer wall (exposed)

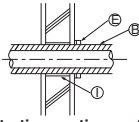

Floor (fireproofing)

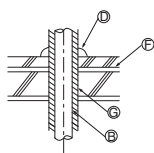

Roof pipe shaft

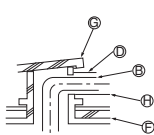

Penetrating portion on fire limit and boundary wall

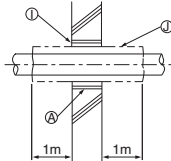

- (A) Sleeve
- (B) Heat insulating material
- (C) Laggings
- (D) Caulking material
- (E) Band
- (F) Waterproofing layer
- (G) Sleeve with edge
- (H) Laggings material
- (I) Mortar or other incombustible caulking
- (J) Incombustible heat insulation material

When filling a gap with mortar, cover the penetration part with steel plate so that the insulation material will not be caved in. For this part, use incombustible materials for both insulation and covering. (Vinyl covering should not be used.)

Electrical Wiring

Caution

1. Follow ordinance of your governmental organization for technical standard related to electrical equipment, wiring regulations and guidance of each electric power company.

WARNING

Be sure to have authorized electrical engineers do the electric work using special circuits in accordance with regulations and this installation manual. If power supply circuit has a lack of capacity or electric work deficiency, it may cause an electric shock or fire.

2. Install the Outdoor Unit transmission line away from the power source wiring so that it is not affected by electric noise from the power source. (Do not run it through the same conduit.)
3. Be sure to provide designated grounding work to Outdoor Unit.

CAUTION

Be sure to correct the outdoor unit to earth. Do not connect earth line to any gas pipe, liquid pipe, lightning rod or telephone earth line. If earth is incomplete, it may cause an electric shock.

4. Give some allowance to wiring for electrical part box of Indoor and Outdoor Units, because the box is sometimes removed at the time of service work.
5. Never connect the main power source to terminal block of transmission line. If connected, electrical parts will be burnt out.
6. Use 2-core shield cable for transmission line. (○ mark in the figure below) If transmission lines of different systems are wired with the same multicore cable, the resultant poor transmitting and receiving will cause erroneous operations. (⊗ mark in the figure below)
7. Only the transmission line specified should be connected to the terminal block for Outdoor Unit transmission.

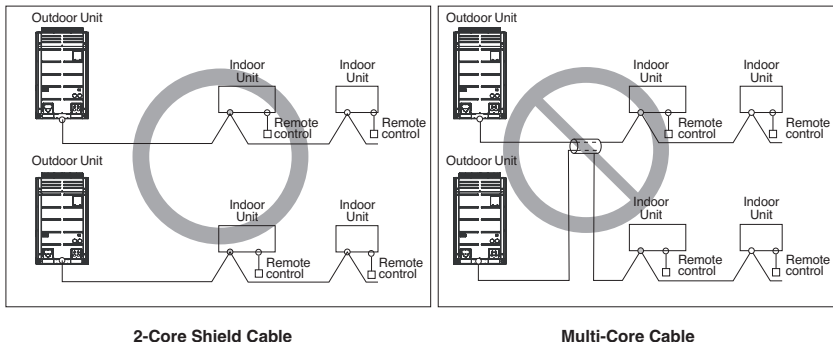

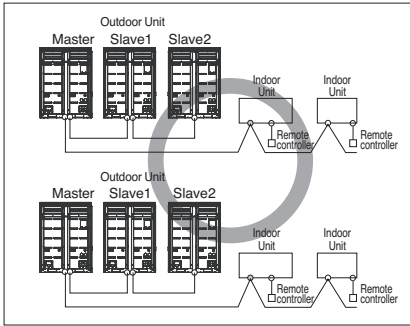

2-Core Shield Cable

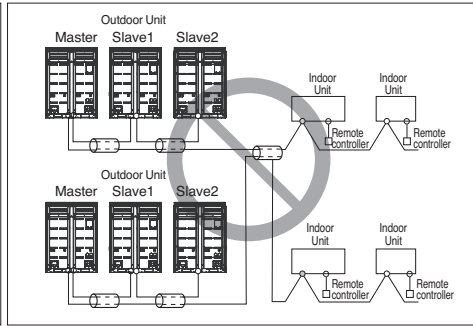

Multi-Core Cable

CAUTION

- Use the 2-core shield cables for transmission lines. Never use them together with power cables.
- The conductive shielding layer of cable should be grounded to the metal part of both units.
- Never use multi-core cable
- As this unit is equipped with an inverter, to install a phase leading capacitor not only will deteriorate power factor improvement effect, but also may cause capacitor abnormal heating. Therefore, never install a phase leading capacitor.
- Make sure that the power unbalance ratio is not greater than 2%. If it is greater the units lifespan will be reduced.

◆ Precautions when laying power and ground wiring

Use round pressure terminals for connections to the power terminal block.

When laying ground wiring, you must use round pressure terminals.

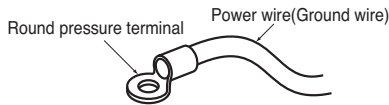

When none are available, follow the instructions below.

- Do not connect wiring of different thicknesses to the power terminal block. (Slack in the power wiring may cause abnormal heat.)

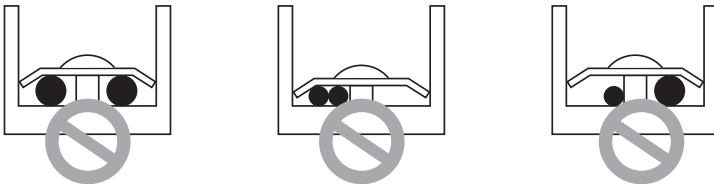

- For wiring, use the designated power wire and connect firmly, then secure to prevent outside pressure being exerted on the terminal block.
- Use an appropriate screwdriver for tightening the terminal screws. A screwdriver with a small head will strip the head and make proper tightening impossible.
- Over-tightening the terminal screws may break them.

Control box and connecting position of wiring

- Remove all of the screws at front panel and remove the panel by pulling it forward.

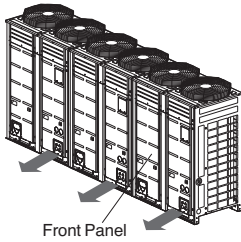

- Connect transmission line between main and sub outdoor unit through the terminal block.
- Connect transmission lines between outdoor unit and indoor units through the terminal block.
- When the central control system is connected to the outdoor unit, a dedicated PCB must be connected between them.
- When connecting transmission line between outdoor unit and indoor units with shielded wire, connect the shield ground to the earth screw.

⚠ WARNING

The temperature sensor for outdoor air should not be exposed to direct sunlight.

- Provide an appropriate cover to intercept direct sunlight.

■ 3Ø 208/230V

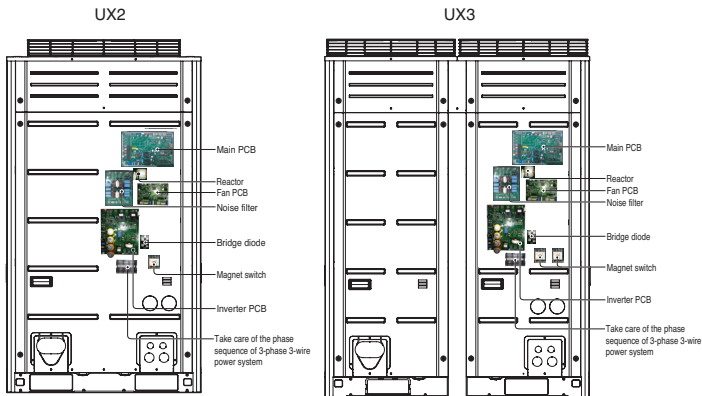

■ 3Ø 460V

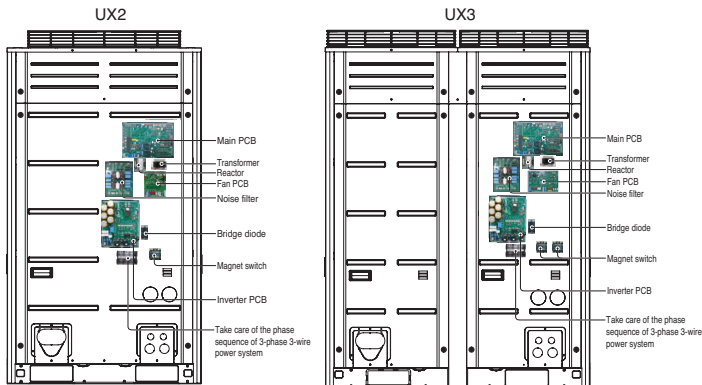

Transmission and Power Lines

1) Communication cable

- Type : shielding wire
- Use wires of size : over 1.0~1.5mm²
- Maximum allowable line length: under 1,000m(3,281ft)

2) Remote control cable

- Type : 3-core cable(shielding wire)

3) Central control cable

Product type	Wire type	Diameter
ACP&AC Manager	(2-shielding wire,2-core wire)	1.0~1.5mm ²
AC Smart	(2-shielding wire,2-core wire)	1.0~1.5mm ²
Simple central controller	(2-shielding wire,2-core wire)	1.0~1.5mm ²

4) Separation of communication and power lines

- If communication and power lines are run alongside each other then there is a strong likelihood of operational faults developing due to interference in the signal wiring caused by electrostatic and electromagnetic coupling.
- The tables below indicates our recommendation as to appropriate spacing of communication and power lines where these are to be run side by side

Current capacity of power line		Spacing
100V or more	10A	300m(11-13/16inch)
	50A	500m(19-11/16inch)
	100A	1,000m(39-3/8inch)
	Exceed 100A	1,500m(59-1/16inch)

Note:

1. The figures are based on assumed length of parallel cabling up to 100m(328ft). For length in excess of 100m(328ft) the figures will have to be recalculated in direct proportion to the additional length of line involved.
 2. If the power supply waveform continues to exhibit some distortion the recommended spacing in the table should be increased.
- If the lines are laid inside conduits then the following point must also be taken into account when grouping various lines together for introduction into the conduits
 - Power lines(including power supply to air conditioner) and signal lines must not be laid inside the same
 - In the same way, when grouping the lines power and signal lines should not be bunched together.



CAUTION

- If apparatus is not properly earthed then there is always a risk of electric shocks, the earthing job of the apparatus must be carried out by a qualified person.

Wiring of main power supply and equipment capacity

1. Use a separate power supply for the Outdoor Unit and Indoor Unit.
2. Bear in mind ambient conditions (ambient temperature, direct sunlight, rain water, etc.) when proceeding with the wiring and connections.
3. The wire size is the minimum value for metal conduit wiring. The power cord size should be 1 rank thicker taking into account the line voltage drops. Make sure the power-supply voltage does not drop more than 10%.
4. Specific wiring requirements should adhere to the wiring regulations of the region.
5. Power supply cords of parts of appliances for outdoor use should not be lighter than polychloroprene sheathed flexible cord.
6. Don't install an individual switch or electrical outlet to disconnect each of indoor unit separately from the power supply.



WARNING

- Follow ordinance of your governmental organization for technical standard related to electrical equipment, wiring regulations and guidance of each electric power company.
- Make sure to use specified wires for connections so that no external force is imparted to terminal connections. If connections are not fixed firmly, it may cause heating or fire.
- Make sure to use the appropriate type of overcurrent protection switch. Note that generated overcurrent may include some amount of direct current.



CAUTION

- Some installation site may require attachment of an earth leakage breaker. If no earth leakage breaker is installed, it may cause an electric shock.
- Do not use anything other than breaker and fuse with correct capacity. Using fuse and wire or copper wire with too large capacity may cause a malfunction of unit or fire.

Field Wiring(3Ø, 208/230V)

1. 60Hz

◆ Example Connection of Transmission Cable

■ 1 Outdoor Unit - 3Ø, 208/230V

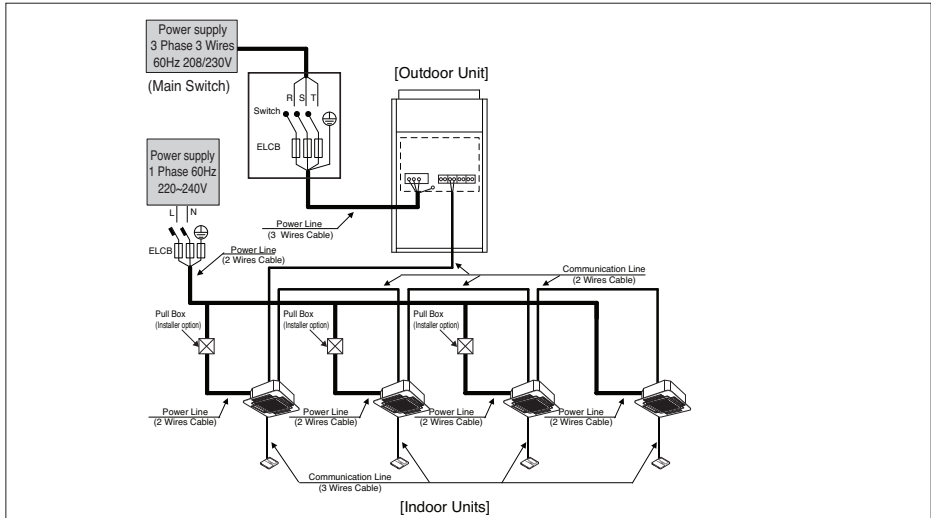

⚠ WARNING

- Indoor Unit ground Lines are required for preventing electrical shock accident during current leakage, Communication disorder by noise effect and motor current leakage (without connection to pipe).
 - Don't install an individual switch or electrical outlet to disconnect each of indoor unit separately from the power supply.
 - Install the main switch that can interrupt all the power sources in an integrated manner because this system consists of the equipment utilizing the multiple power sources.
 - If there exists the possibility of reversed phase, lose phase, momentary blackout or the power goes on and off while the product is operating, attach a reversed phase protection circuit locally.
- Running the product in reversed phase may break the compressor and other parts.

[Heat Pump]

Between Indoor and Master Outdoor unit

SODU	IDU	INTERNET	DRY1	DRY2	GND	12V	Master Outdoor Unit
B	A	B	A	B	A		

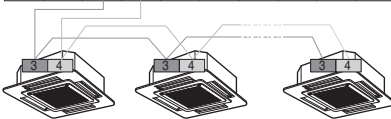

The GND terminal at the main PCB is a '-' terminal for day contact, it is not the point to make ground connection.

Note

- 1) Field Wiring diagram is to be used as a guideline only. Wiring should comply with applicable local and national codes
- 2) ELCB must have function to prevent electrical short and over current at the same time .
- 3) Use copper wires only.
- 4) Unit must be grounded in compliance with the applicable local and national codes.
- 5) ELCB and fuse/breaker must install to the power line

■ 2 Outdoor Units - 3Ø, 208/230V

■ Do not install the power source connected in series between the units.

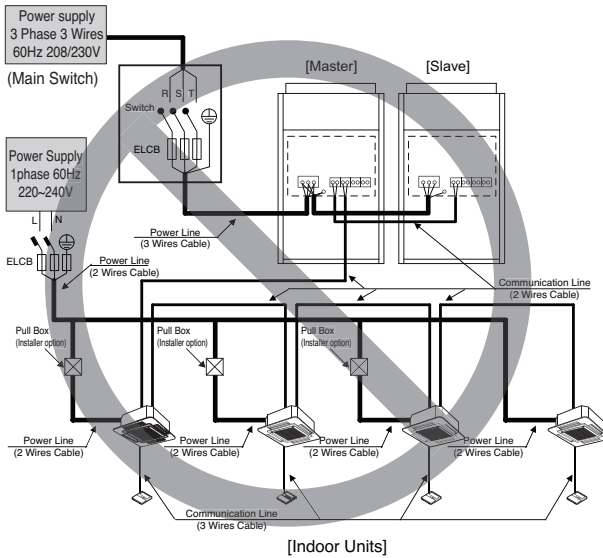

■ Be sure that the power source is supplied to Each outdoor unit individually.

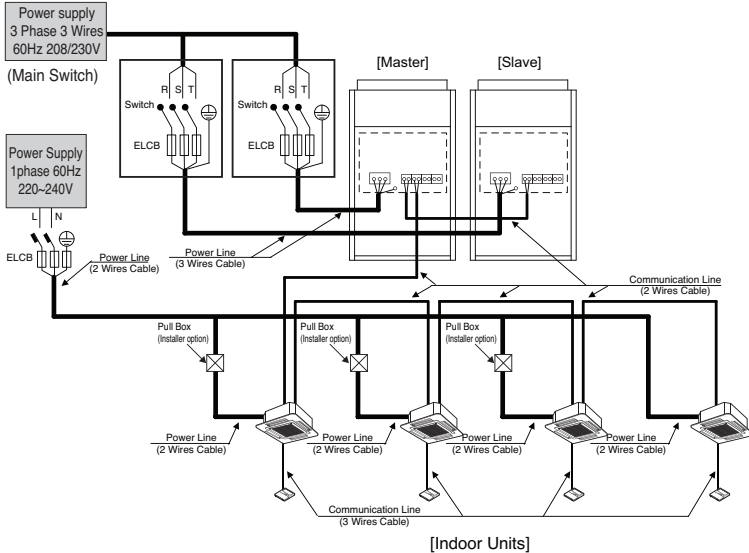

Note

- 1) Field Wiring diagram is to be used as a guideline only. Wiring should comply with applicable local and national codes
- 2) ELCB must have function to prevent electrical short and over current at the same time .
- 3) Use copper wires only.
- 4) Unit must be grounded in compliance with the applicable local and national codes.
- 5) ELCB and fuse/breaker must install to the power line



WARNING

- Indoor Unit ground Lines are required for preventing electrical shock accident during current leakage, Communication disorder by noise effect and motor current leakage (without connection to pipe).
- Don't install an individual switch or electrical outlet to disconnect each of indoor unit separately from the power supply.
- Install the main switch that can interrupt all the power sources in an integrated manner because this system consists of the equipment utilizing the multiple power sources.
- If there exists the possibility of reversed phase, lose phase, momentary blackout or the power goes on and off while the product is operating, attach a reversed phase protection circuit locally.
Running the product in reversed phase may break the compressor and other parts.

[Heat Pump]

Between Indoor and Master Outdoor unit

SODU		IDU		INTERNET	DRY1	DRY2	GND	12V
B	A	B	A	B	A			

Master
Outdoor Unit

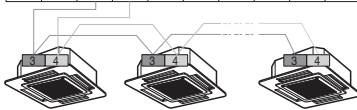

SODU		IDU		INTERNET	DRY1	DRY2	GND	12V
B	A	B	A	B	A			

Master
Outdoor Unit

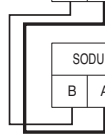

SODU		IDU		INTERNET	DRY1	DRY2	GND	12V
B	A	B	A	B	A			

Slave
Outdoor Unit

The GND terminal at the main PCB is a '-' terminal for dry contact.
It is not the point to make ground connection.

- Make sure that terminal number of master and slave outdoor units are matched.(A-A,B-B)

■ 3 Outdoor Units - 3Ø, 208/230V

■ Do not install the power source connected in series between the units.

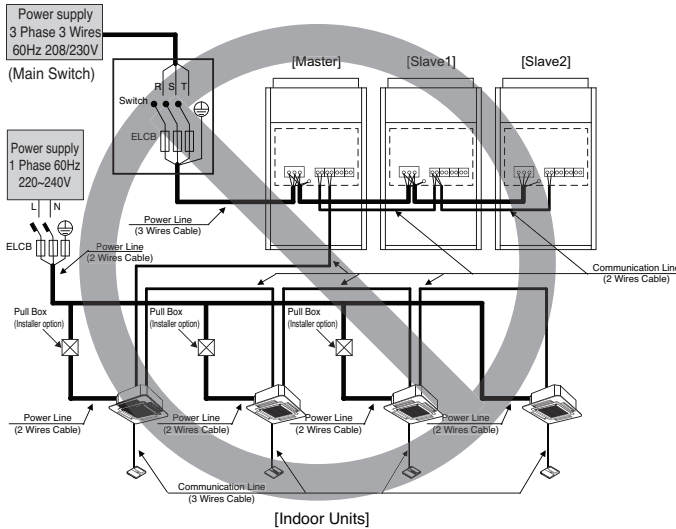

■ Be sure that the power source is supplied to Each outdoor unit individually.

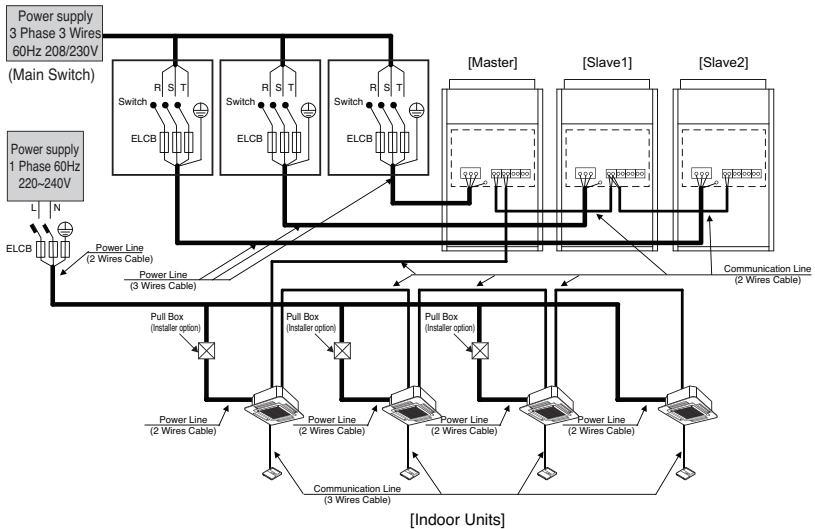

Note

- 1) Field Wiring diagram is to be used as a guideline only. Wiring should comply with applicable local and national codes
- 2) ELCB must have function to prevent electrical short and over current at the same time .
- 3) Use copper wires only.
- 4) Unit must be grounded in compliance with the applicable local and national codes.
- 5) ELCB and fuse/breaker must install to the power line

⚠ WARNING

- Indoor Unit ground Lines are required for preventing electrical shock accident during current leakage, Communication disorder by noise effect and motor current leakage (without connection to pipe).
- Don't install an individual switch or electrical outlet to disconnect each of indoor unit separately from the power supply.
- Install the main switch that can interrupt all the power sources in an integrated manner because this system consists of the equipment utilizing the multiple power sources.
- If there exists the possibility of reversed phase, lose phase, momentary blackout or the power goes on and off while the product is operating, attach a reversed phase protection circuit locally.
Running the product in reversed phase may break the compressor and other parts.

[Heat Pump]

Between Indoor and Master Outdoor unit

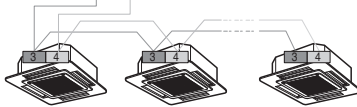
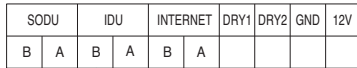

The GND terminal at the main PCB is a '⌋' terminal for dry contact.
It is not the point to make ground connection.

- Make sure that terminal number of master and slave outdoor units are matched.(A-A,B-B)

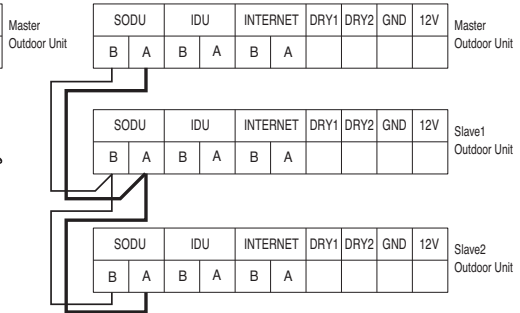

Field Wiring(3Ø, 460V)

1. 60Hz

◆ Example Connection of Communication Cable

■ 1 Outdoor Unit - 3Ø, 460V

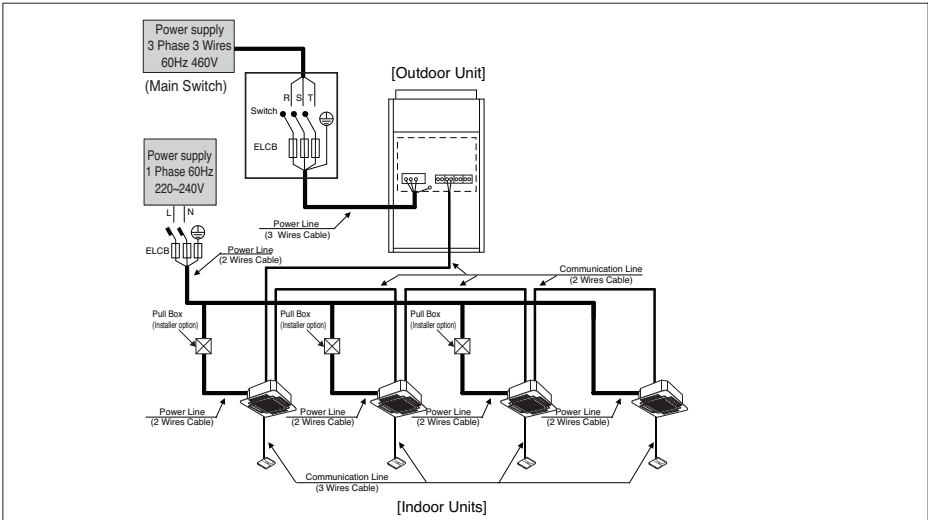

⚠ WARNING

- Indoor Unit ground Lines are required for preventing electrical shock accident during current leakage, Communication disorder by noise effect and motor current leakage (without connection to pipe).
- Don't install an individual switch or electrical outlet to disconnect each of indoor unit separately from the power supply.
- Install the main switch that can interrupt all the power sources in an integrated manner because this system consists of the equipment utilizing the multiple power sources.
- If there exists the possibility of reversed phase, lose phase, momentary blackout or the power goes on and off while the product is operating, attach a reversed phase protection circuit locally.
Running the product in reversed phase may break the compressor and other parts.

[Heat Pump]

Between Indoor and Master Outdoor unit

SODU	IDU	INTERNET	DRY1	DRY2	GND	12V	Master Outdoor Unit
B	A	B	A	B	A		

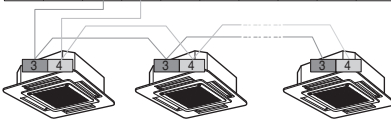

The GND terminal at the main PCB is a '-' terminal for day contact, it is not the point to make ground connection.

Note

- 1) Field Wiring diagram is to be used as a guideline only. Wiring should comply with applicable local and national codes
- 2) ELCB must have function to prevent electrical short and over current at the same time .
- 3) Use copper wires only.
- 4) Unit must be grounded in compliance with the applicable local and national codes.
- 5) ELCB and fuse/breaker must install to the power line

■ 2 Outdoor Units - 3Ø, 460V

■ When the power source is connected in series between the units.

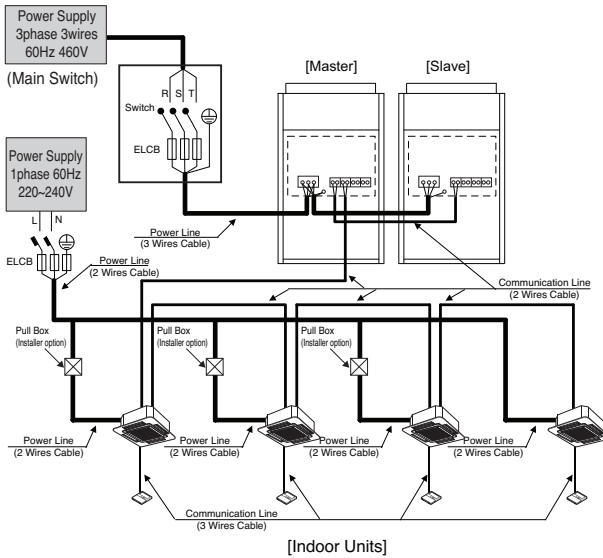

■ Be sure that the power source is supplied to Each outdoor unit individually.

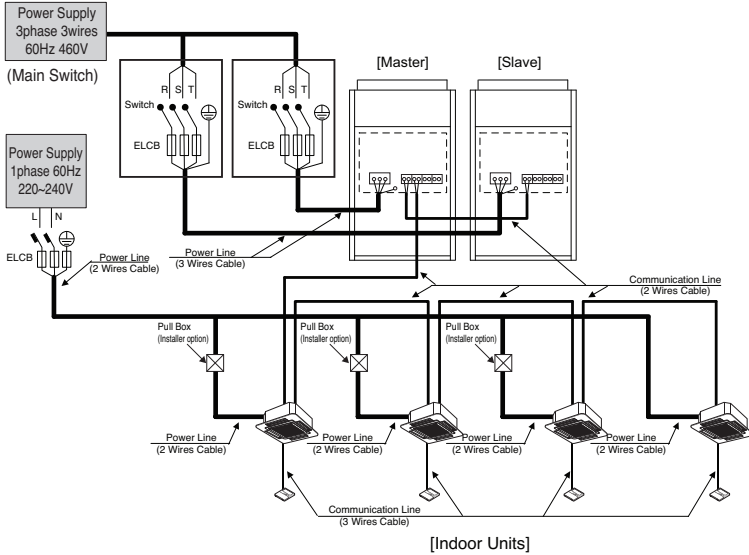

Note

- 1) Field Wiring diagram is to be used as a guideline only. Wiring should comply with applicable local and national codes
- 2) ELCB must have function to prevent electrical short and over current at the same time .
- 3) Use copper wires only.
- 4) Unit must be grounded in compliance with the applicable local and national codes.
- 5) ELCB and fuse/breaker must install to the power line

⚠ WARNING

- Indoor Unit ground Lines are required for preventing electrical shock accident during current leakage, Communication disorder by noise effect and motor current leakage (without connection to pipe).
- Don't install an individual switch or electrical outlet to disconnect each of indoor unit separately from the power supply.
- Install the main switch that can interrupt all the power sources in an integrated manner because this system consists of the equipment utilizing the multiple power sources.
- If there exists the possibility of reversed phase, lose phase, momentary blackout or the power goes on and off while the product is operating, attach a reversed phase protection circuit locally.
Running the product in reversed phase may break the compressor and other parts.

[Heat Pump]

Between Indoor and Master Outdoor unit

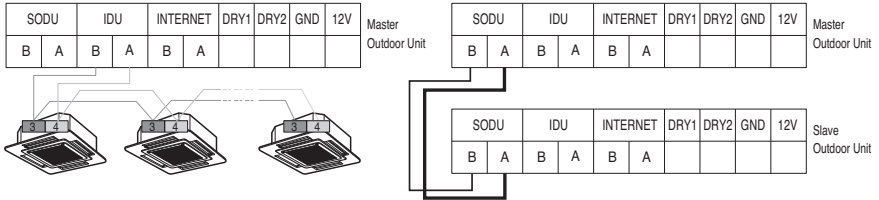

The GND terminal at the main PCB is a '-' terminal for dry contact.
It is not the point to make ground connection.

- Make sure that terminal number of master and slave outdoor units are matched.(A-A,B-B)

■ 3 Outdoor Units - 3Ø, 460V

■ When the power source is connected in series between the units.

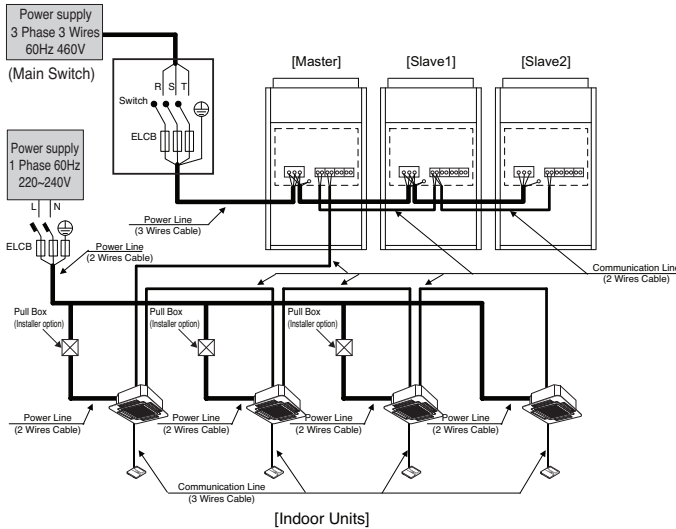

■ Be sure that the power source is supplied to Each outdoor unit individually.

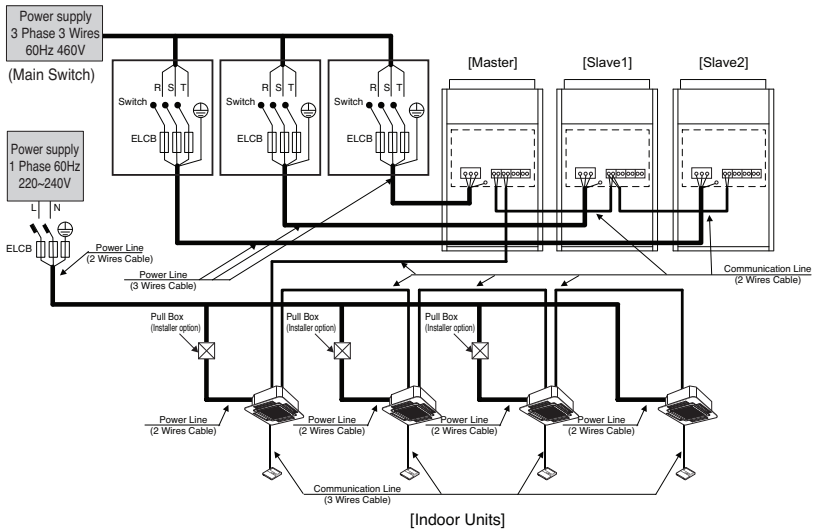

Note

- 1) Field Wiring diagram is to be used as a guideline only. Wiring should comply with applicable local and national codes
- 2) ELCB must have function to prevent electrical short and over current at the same time .
- 3) Use copper wires only.
- 4) Unit must be grounded in compliance with the applicable local and national codes.
- 5) ELCB and fuse/breaker must install to the power line

⚠ WARNING

- Indoor Unit ground Lines are required for preventing electrical shock accident during current leakage, Communication disorder by noise effect and motor current leakage (without connection to pipe).
- Don't install an individual switch or electrical outlet to disconnect each of indoor unit separately from the power supply.
- Install the main switch that can interrupt all the power sources in an integrated manner because this system consists of the equipment utilizing the multiple power sources.
- If there exists the possibility of reversed phase, lose phase, momentary blackout or the power goes on and off while the product is operating, attach a reversed phase protection circuit locally.
Running the product in reversed phase may break the compressor and other parts.

[Heat Pump]

Between Indoor and Master Outdoor unit

SODU	IDU	INTERNET	DRY1	DRY2	GND	12V
B	A	B	A			

Master
Outdoor Unit

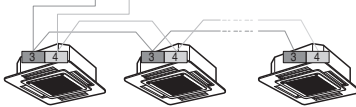

The GND terminal at the main PCB is a '⌋' terminal for dry contact.
It is not the point to make ground connection.

- Make sure that terminal number of master and slave outdoor units are matched.(A-A,B-B)

SODU	IDU	INTERNET	DRY1	DRY2	GND	12V
B	A	B	A			

Master
Outdoor Unit

SODU	IDU	INTERNET	DRY1	DRY2	GND	12V
B	A	B	A			

Slave1
Outdoor Unit

SODU	IDU	INTERNET	DRY1	DRY2	GND	12V
B	A	B	A			

Slave2
Outdoor Unit

◆ Example Connection of Transmission Cable

[BUS type]

- Connection of transmission cable must be installed like below figure between indoor unit to outdoor unit.

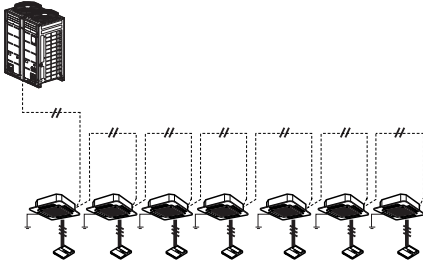

[STAR type]

- Abnormal operation can be caused by communication defect, when connection of transmission cable is installed like below figure (STAR type).

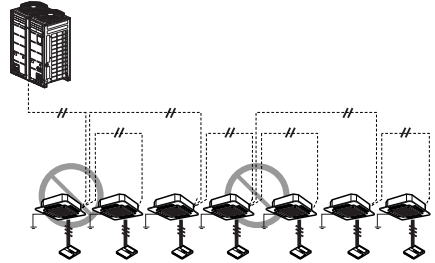

◆ UX2 Chassis Wire Connection (3Ø, 208/230V)

Left Side

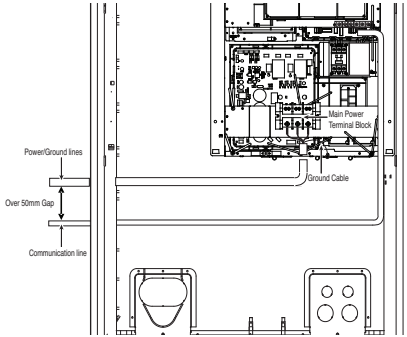

Right Side

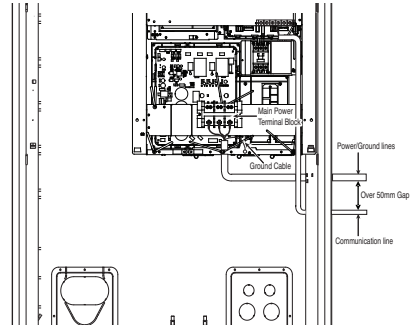

Front Side 1

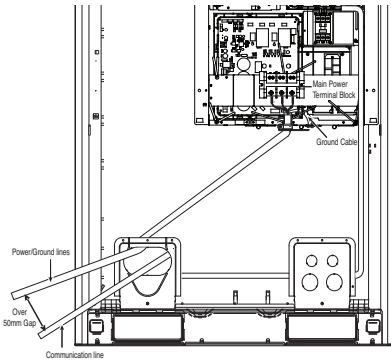

Front Side 2

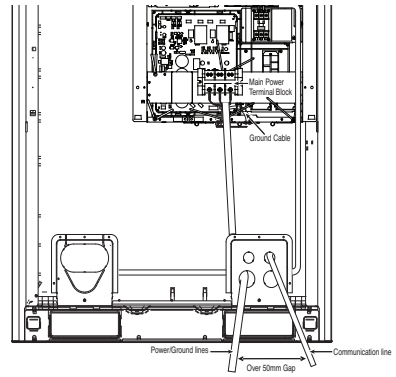

Main Power Connection

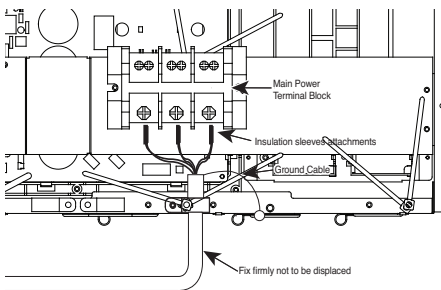

Main PCB Connection

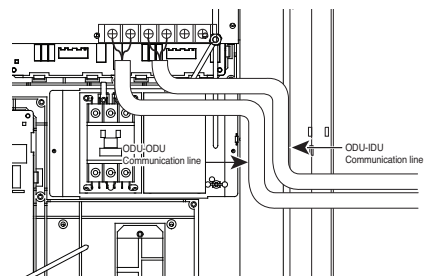

◆ UX3 Chassis Wire Connection (3Ø, 208/230V)

Left Side

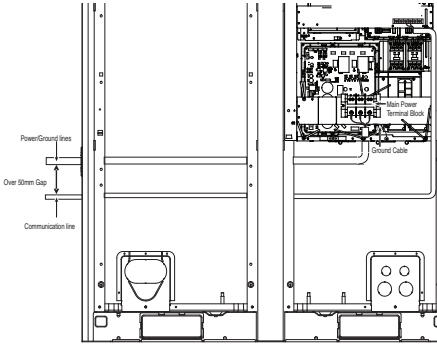

Right Side

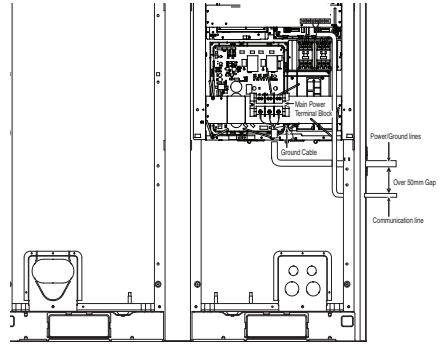

Front Side 1

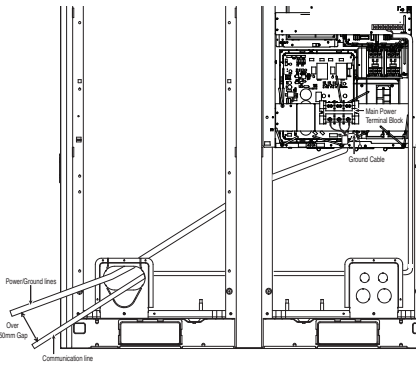

Front Side 2

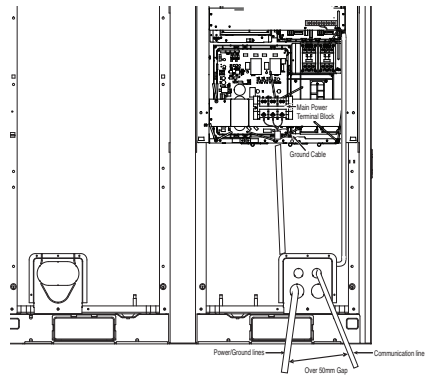

Main Power Connection

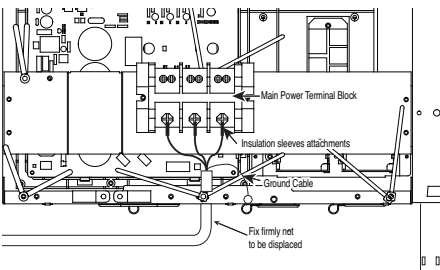

Main PCB Connection

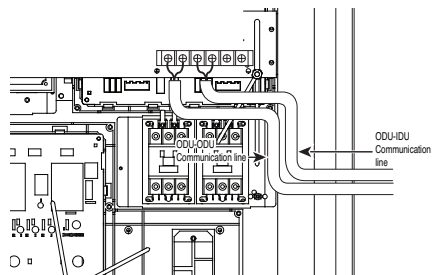

◆ UX2 Chassis Wire Connection (3Ø, 460V)

Left Side

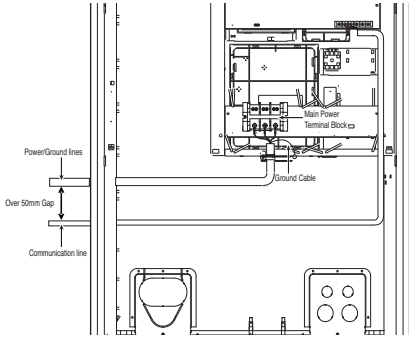

Right Side

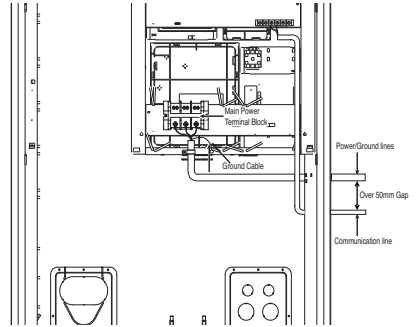

Front Side 1

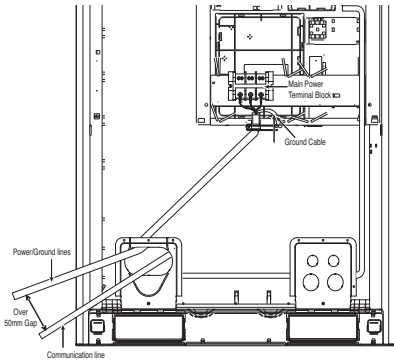

Front Side 2

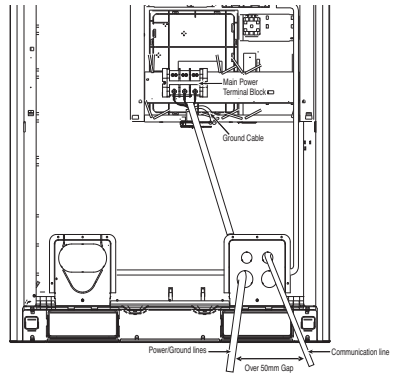

Main Power Connection

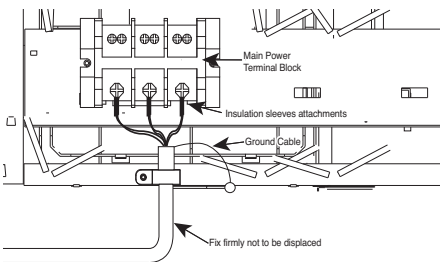

Main PCB Connection

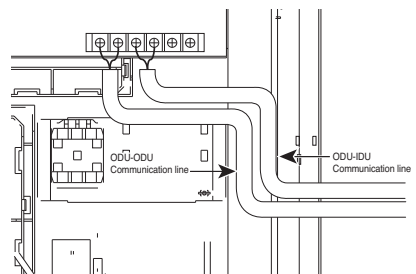

◆ UX3 Chassis Wire Connection (3Ø, 460V)

Left Side

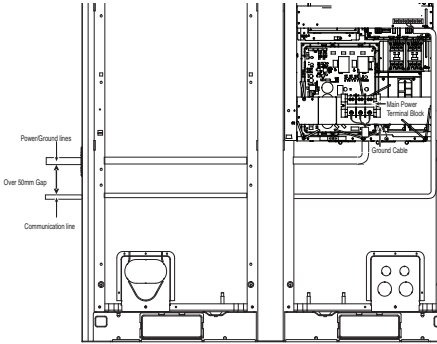

Right Side

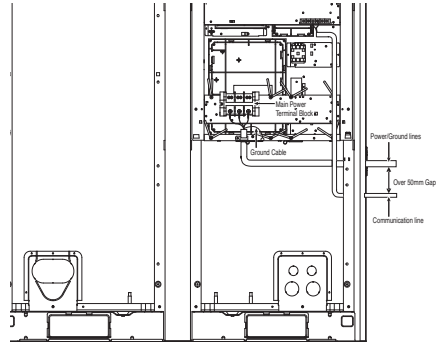

Front Side 1

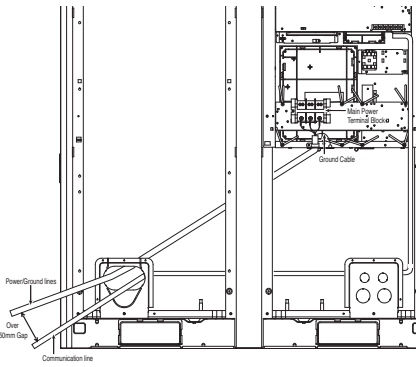

Front Side 2

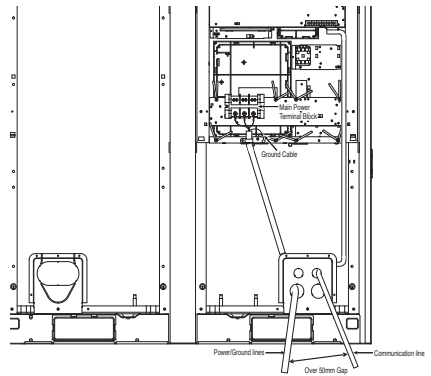

Main Power Connection

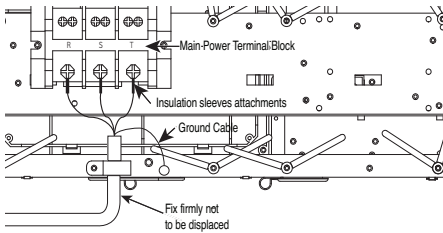

Main PCB Connection

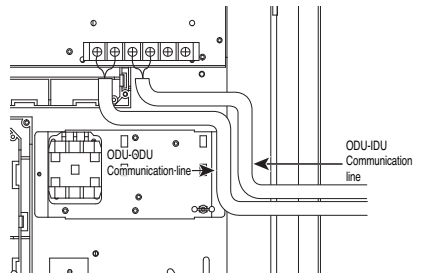

Location of setting dip switch

■ Heat Pump (Main PCB)

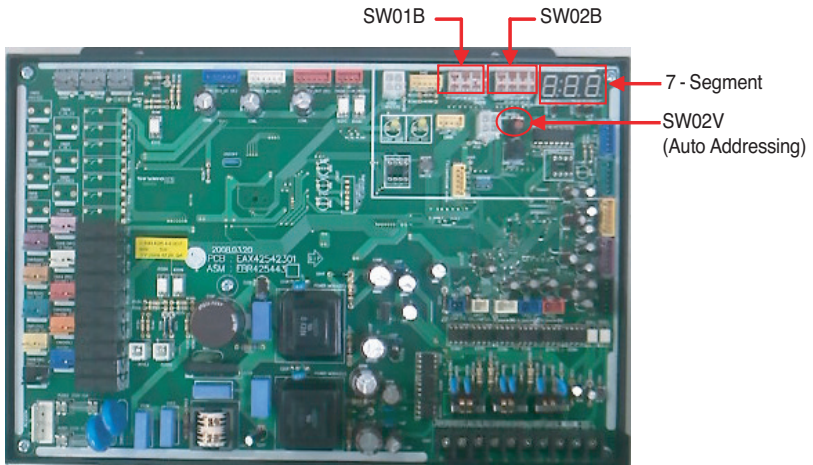

DIP switch setting

■ Checking according to dip switch setting

1. You can check the setting values of the Master outdoor unit from the 7 segment LED.
The dip switch setting should be changed when the power is OFF.
2. It checks whether the input is properly performed without the bad contact of the dip switch or not

■ Checking the setting of the Master unit

The number is sequentially appeared at the 7 segment in 5 seconds after applying the power. This number represents the setting condition. (For example, represents R410A 28HP)

Master model code → Slave1 model code → Slave2 model code → total capacity → 2 → 25 → 140 or 160

- 1 ~255 : Master model code
 - 1 ~255 : Slave1 model code
 - 1 ~255 : Slave2 model code
 - 1 ~255 : Slave3 model code
- } Refer to table code
- 8~42HP : HP number(sum of master capacity and slave capacity)
 No display : cooling only 2 : heat pump
 25 : normal
 140 or 160 : Model Type (ARUNxxBT3:140, ARUNxxDT3:160)

Example) 28Hp, R410A

15 → 15 → 30 → 2 → 25 → 140 or 160



CAUTION

Product may not properly operate if the relevant DIP switch is not properly setup.

Model Code

Model Code	Unit (HP)	Unit	Ref.
12	8	Master & Slave	R410A
13	10		
14	12		
15	14		

■ Setting the DIP switch

• Heat pump

- If you set the Dip switch when power is on, the changed setting will not be applied immediately. The changed setting will be enabled only when Power is reset or by pressing Reset button.

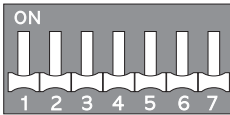

1 2 3 4 5 6 7

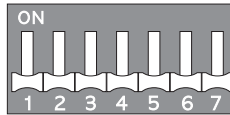

8 9 10 11 12 13 14

Index		1	2	3	4	5	6	7	8	9	10	11	12	13	14		
Function	Heating capacity up	●															
	IDU Fan RPM Control		●														
	Auto charging	●	●					●						x	x		
	Refrigerant Checking Function	●	●					●						x	●		
	Integrated test operation function (Cooling)	●	●					x						●	x		
	Integrated test operation function (Heating)	●	●					x						●	●		
	Inverter backup			●													
	Unit backup				●												
	Non-operation indoor unit EEV adjustment	x	x			●	x	x									
	Indoor unit target subcooling/overheating adjustment	x	x			x	●	x									
	Operation indoor unit EEV adjustment	x	●			●	x	x									
	Dry contact					●	●	x									
	Snow removal function									●	x						
	Forced defrost									x	●						
	Snow removal+Forced defrost									●	●						
	Forced overall defrost							●									●
	Static pressure mode	x	x											x	●	x	
	High low noise operation (Cooling only)													●	x	●	
	Night low noise operation (Cooling/Heating)													●	●	●	
	Pump down											●					x
	Pump out											●					●
	Forced oil return operation	x	x						●								x
	Vacuum mode												●	x	x	●	
	Selector Fan/ All OFF	x	x										●	●	x	x	
	ODU Address setting												●	x	x	x	
	ODU setting	Master unit					x	x	x								
Slave 1 unit						●	x	●									
Slave 2 unit						x	●	●									

⚠ CAUTION

- 'X' mark within the table means that the dip switch must be pulled down. If not, the function may not work properly.
- If the applicable dip switch is not set properly, the product may not work properly.
- When executing the test operation, check the operating condition of the indoor unit and only execute the operation when all indoor units are stopped.
- Auto test operation function does not work for the product where only one indoor unit is connected for use.
- Cooling Only model is not working on functions of Heat Pump model.

Automatic Addressing

• The address of indoor units would be set by auto addressing

- 1) Wait for 3 minutes after supplying power. (Master and Slave outdoor units, indoor units)
- 2) Press RED button of the outdoor units for 5 seconds. (H/P : SW02B)
- 3) A "88" is indicated on 7-segment LED of the outdoor unit PCB.
- 4) For completing addressing, 2~7 minutes are required depending on numbers of connected indoor units
- 5) Numbers of connected indoor units whose addressing is completed are indicated for 30 seconds on 7-segment LED of the outdoor unit PCB
- 6) After completing addressing, address of each indoor unit is indicated on the wired remote control display window. (CH00, CH01, CH02,, CH06 : Indicated as number of connected indoor units)

■ Heat Pump (Main PCB)

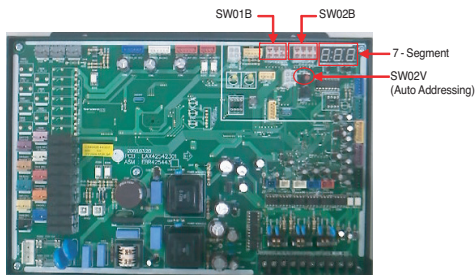

⚠ CAUTION

- In replacement of the indoor unit PCB, always perform Auto addressing setting again (At that time, please check about using Independent power module to any indoor unit.)
- If power supply is not applied to the indoor unit, operation error occur.
- Auto addressing is only possible on the master Unit.
- Auto addressing has to be performed after 3 minutes to improve communication.

◆ The Procedure of Automatic Addressing

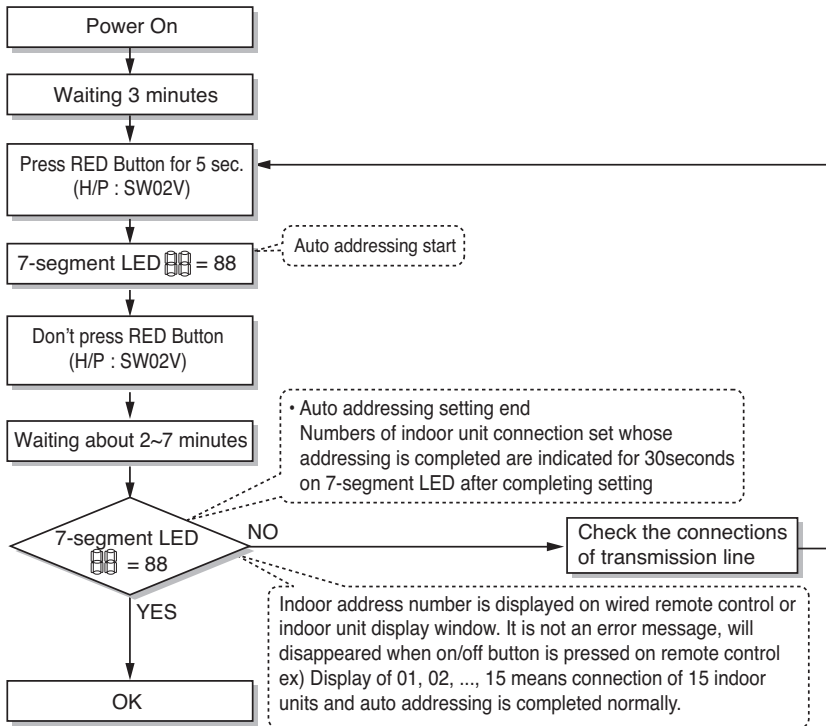

Group Number setting

Group Number setting for Indoor Units

- ① Confirm the power of whole system(Indoor Unit, Outdoor Unit) is OFF, otherwise turn off.
- ② The transmission lines connected to INTERNET terminal should be connected to central control of Outdoor Unit with care for their polarity(A → A, B → B)
- ③ Turn the whole system on.
- ④ Set the group and Indoor Unit number with a wired remote control.
- ⑤ To control several sets of Indoor Units into a group, set the group ID from 0 to F for this purpose.

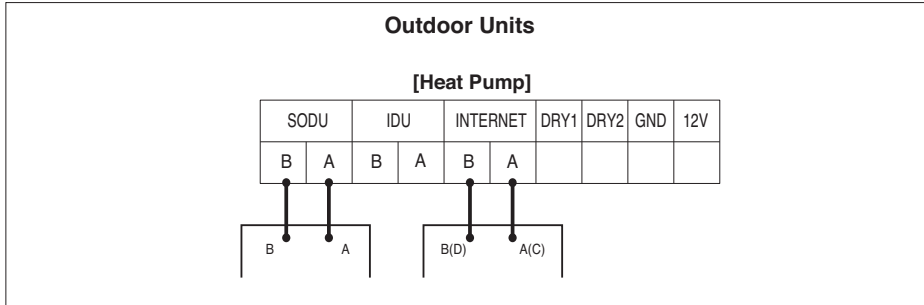

Example) Group number setting

1 E

Group Indoor unit

1st number indicate the group number

2nd number point out indoor unit number

Group recognizing the simple central controller
No.0 group (00~0F)
No.1 group (10~1F)
No.2 group (20~2F)
No.3 group (30~3F)
No.4 group (40~4F)
No.5 group (50~5F)
No.6 group (60~6F)
No.7 group (70~7F)
No.8 group (80~8F)
No.9 group (90~9F)
No. A group (A0~AF)
No. B group (B0~BF)
No. C group (C0~CF)
No. D group (D0~DF)
No. E group (E0~EF)
No. F group (F0~FF)

Cool/Heat Selector Installation and Connection

Using Cool/Heat Selector Installation and Connection

- Connect wires to the cool/heat selector as shown in below figure
- Insert the wire in terminal by pushing "push" button
- Set the Dip SW of main PCB in master outdoor unit

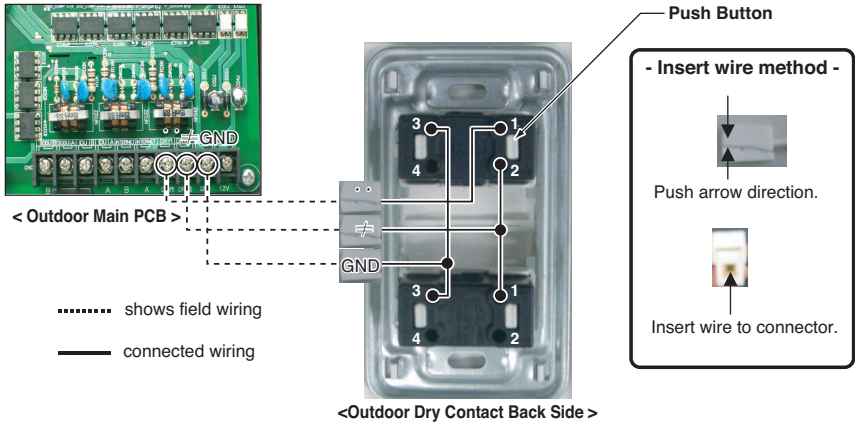

* Communication line length can be maximum 300m, use communication line as thick as 1.25mm².

Without Cool/Heat Selector Installation and Connection

In case, try to set mode without Cool/Heat Selector and try to use other switch except from LG Outdoor Cool/Heat Selector in field.

Connect signal terminal block as below figure and description.

- How to set mode without Cool/Heat Selector

• Cooling Mode Setting

- ① → GND Connection
- ② → Off (Open)

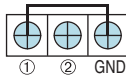

• Heating Mode Setting

- ① → GND Connection
- ② → GND Connection

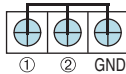

• Fan/ All OFF Mode Setting

- ① → Off (Open)
- ② → GND Connection

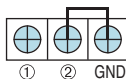

Test Run

Checks Before Test Run

1	Check to see whether there is any refrigerant leakage, and slack of power or transmission cable.
2	<p>Confirm that 500 V megger shows 2 MΩ or more between power supply terminal block and ground. Do not operate in the case of 2 MΩ or less.</p> <p>NOTE: Never carry out megaohm check over terminal control board. Otherwise the control board would be broken.</p> <p>Immediately after mounting the unit or after leaving it turned off for an extended length of time, the resistance of the insulation between the power supply terminal board and the ground may decrease to approx. 2 MΩ as a result of refrigerant accumulating in the internal compressor. If the insulation resistance is less than 2 MΩ, turning on the main power supply and energizing the crankcase heater for more than 6 hours will cause the refrigerant to evaporate, increasing the insulation resistance.</p>
3	<p>Check if high/low pressure common pipe, liquid pipe and gas pipe valves are fully opened.</p> <p>NOTE: Be sure to tighten caps.</p>
4	<p>Check if there are any problems in automatic addressing or not:</p> <p>Check and confirm that there are no error messages in the display of indoor units or remote controls and LED in outdoor units.</p>



CAUTION

when cutting main power of the Multi V

- Always apply main power of the outdoor unit during use of product (cooling season/heating season).
- Always apply power 6 hours in advance to heat the crank case heater where performing test run after installation of product. It may result in burning out of the compressor if not preheating the crank case with the electrical heater for more than 6 hours. (In case of the outdoor temperature below 10°C)

How to Cope with Test Run Abnormality

The phenomena from main component failure

Component	Phenomenon	Cause	Check method and Trouble shooting
Compressor	Not operating	Motor insulation broken	Check resistance between terminals and chassis
		Strainer clogged	Change strainer
		Oil leakage	Check oil amount after opening oil port
	Stop during running	Motor insulation failure	Check resistance between terminals and chassis
	Abnormal noise during running	R-S-T misconnection	Check compressor R-S-T connection
Outdoor fan	High pressure error at cooling	Motor failure, bad ventilation around outdoor heat exchanger	Check the outdoor fan operation after being turned the outdoor units off for some time. Remove obstacles around the outdoor units
Outdoor EEV	Heating failure, frequent defrosting	Bad connector contact	Check connector
	No operating sound at applying power	Coil failure	Check resistance between terminals
	Heating failure, frozen outdoor heat exchanger part	EEV clogged	Service necessary
	Low pressure error or discharge temperature error	EEV clogged	Service necessary

When system fault occurs, the error code is displayed at indoor unit display or remote control display, the trouble shooting guide is in the service manual

Add Note : For detailed information, please refer Multi V Troubleshooting Guide Book

Sensor Checking Function

Sensor checking function judges whether the current temperature of indoor and outdoor unit sensors is right or not. 3 indoor temperature sensors, 10 outdoor temperature sensor (Note 1), 2 outdoor pressure sensors.

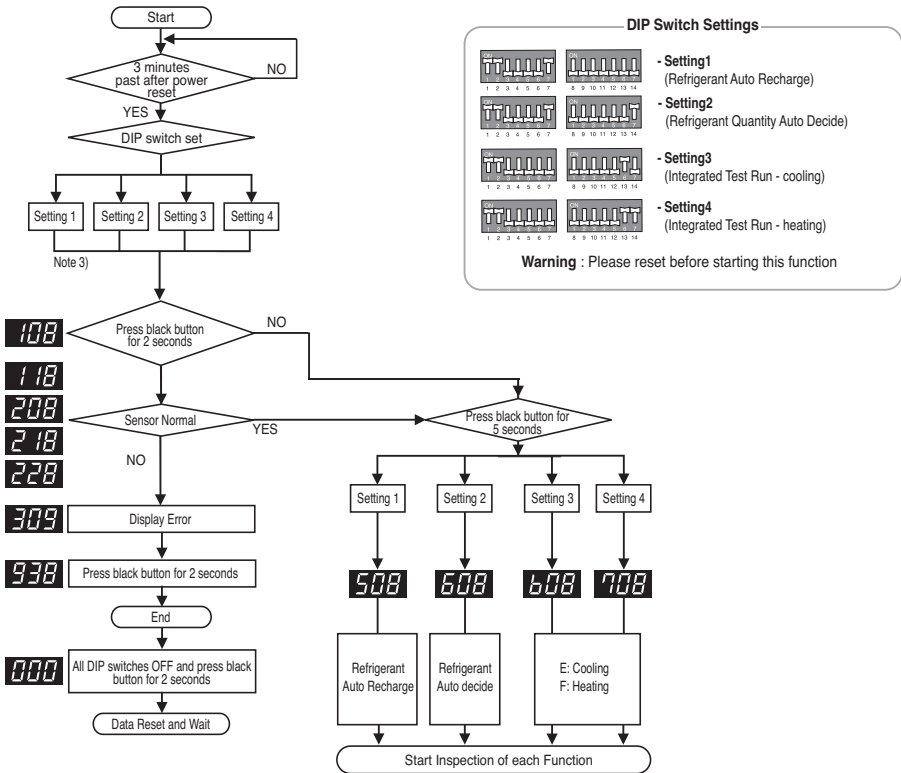

Note 1. Outdoor Unit number of temperature sensors is different according to each chassis.

	UX2(1 Comp)	UX3 (2 Comp)
Heat Pump	6	7

Note 2. Please check the sensor that is found abnormal.

Note 3. Each step is displayed on the Main PCB LED.

Note 4. Please refer to the sensor error descriptions on the next page.

WARNING

1. Please confirm if auto addressing function was executed. (Check the number of installed indoor units)
2. Error may occur when the sensor is abnormal according to the installed location and the temperature conditions. When error occurs, please check each sensor and decide faultiness.

Refrigerant Auto Charging

This function charges appropriate amount of refrigerant automatically through cycle operation. It can be used when refrigerant amount isn't certain because of SVC and leakage.

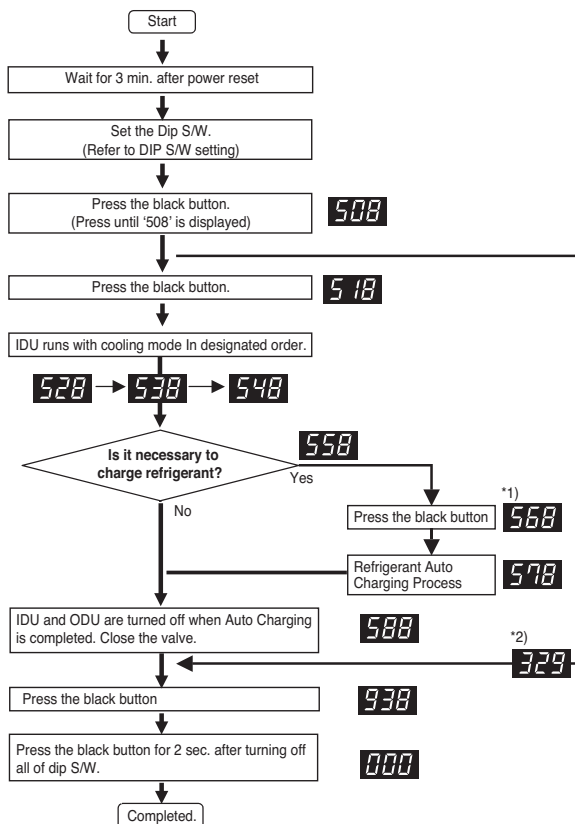

DIP Switch Settings

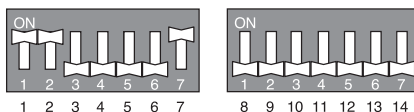

Warning : Please reset Main PCB before starting this function

Note

1. After installing the refrigerant charging device, **558** as shown in figure, open the valve
2. In case air temperature is out of guaranteed temperature, it may end without performing Auto charging
3. Refrigerant charging Time may change according to the charging amount. (Abt. 1.5min/lbs)

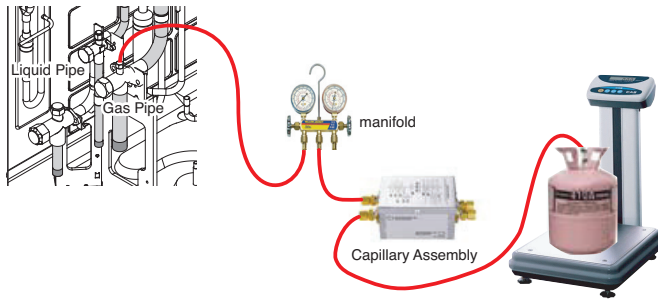

Procedure

1. Arrange manifold, capillary assembly, refrigerant vessel and scale
2. Connect manifold to the gas pipe service valve of ODU as shown in the figure.
3. Connect manifold and Capillary tube.
Use designated capillary assembly only.
If designated capillary assembly isn't used, the system may get damaged.
4. Connect capillary and refrigerant vessel.
5. Purge hose and manifold.
6. After **568** is displayed, open the valve and charge the refrigerant

■ Error contents about auto refrigerant charging function

1. **329** : Temperature Range Error (In case that IDU or ODU is out of range)
2. **339** : Low Pressure Descent Error (In case the system runs at low pressure limit for over 10 minutes)
3. **349** : Judging rapid refrigerant inflow (In case the liquid refrigerant flows in because of not using designated Capillary Assembly)
4. **359** : Instability Error(In case the high/low pressure target doesn't get satisfied for some time after the starting operation)

⚠ CAUTION

1. Guaranteed temperature range (Error will occur if temperature is out of range)
IDU : 20°C(68°F) ~ 32°C(90°F)
ODU : 0°C(32°F) ~ 43°C (109°F)
This temperature range is specifically for accurate refrigerant charging and is irrelative of operation temperature range
2. For refrigerant charging, use designated device only. (Capillary Assembly Set)
3. Set the IDU wired remote controller temperature sensing mode as IDU
4. Be careful that IDU should not be thermo off.

Refrigerant Checking Function

This function judges refrigerant leakage and overcharging. It can be used with refrigerant auto charging function.

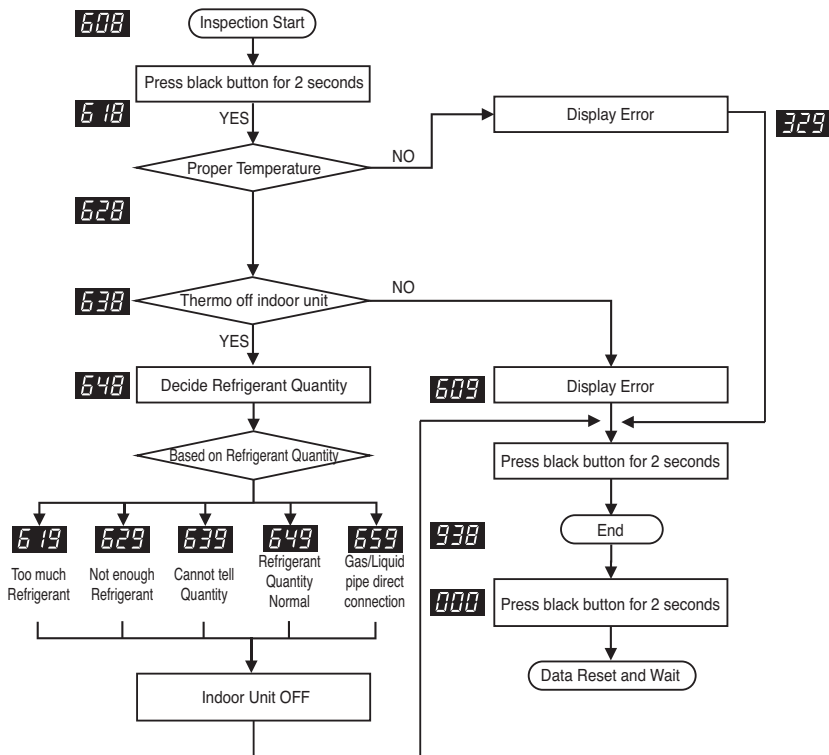

DIP Switch Settings

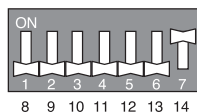
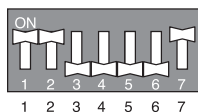

Warning : Please reset Main PCB before starting this function

Note

1. In case air temperature is out of guaranteed temperature, refrigerant checking function may end without performing refrigerant checking. Use guaranteed temperature range only.
2. During the process of judging refrigerant amount, if the cycle isn't stable, refrigerant checking function may end without performing refrigerant checking.



CAUTION

1. **Guaranteed Temperature range(Error occurs out of guaranteed temperature range)**
IDU : 20°C(68°F) ~ 32°C(90°F)
ODU : 0°C(32°F) ~ 43°C (109°F)
2. Set IDU wired remote controller temperature sensor setting as 'IDU'.
3. Make certain that IDU doesn't run with thermo off mode during operation.

[Error contents about auto refrigerant charging function]

1. **329** : Temperature Range Error (In case that IDU or ODU is out of range)
2. **609** : System Unstable Error (In case, After 45 min operating the system, it does not be stable)

How to Cope with Result of Refrigerant checking

1. If the temperature is not in guaranteed Temperature range, the system will not execute Refrigerant checking and the system will be OFF.
2. **Excess of Refrigerant(619)**
After remove the 20% of calculated total refrigerant, recharge the refrigerant by using Refrigerant Auto Charging Function.
3. **Scarcity of Refrigerant(629)**
Charge the refrigerant by using Refrigerant Auto Charging Function.
4. **Impossible to Judge(639)**
IF the system is not in order, check the other problem except refrigerant.

Integrated Test Running Function_Cooling Mode (Setting 3)

This function is checking process for normal operation of parts and system On operating system.

- All processes carry out included refrigerant amount judge logic and check normal condition of parts on cooling mode.
- This function check only normal condition of parts on heating mode.
- Saved data can check using LGMV.

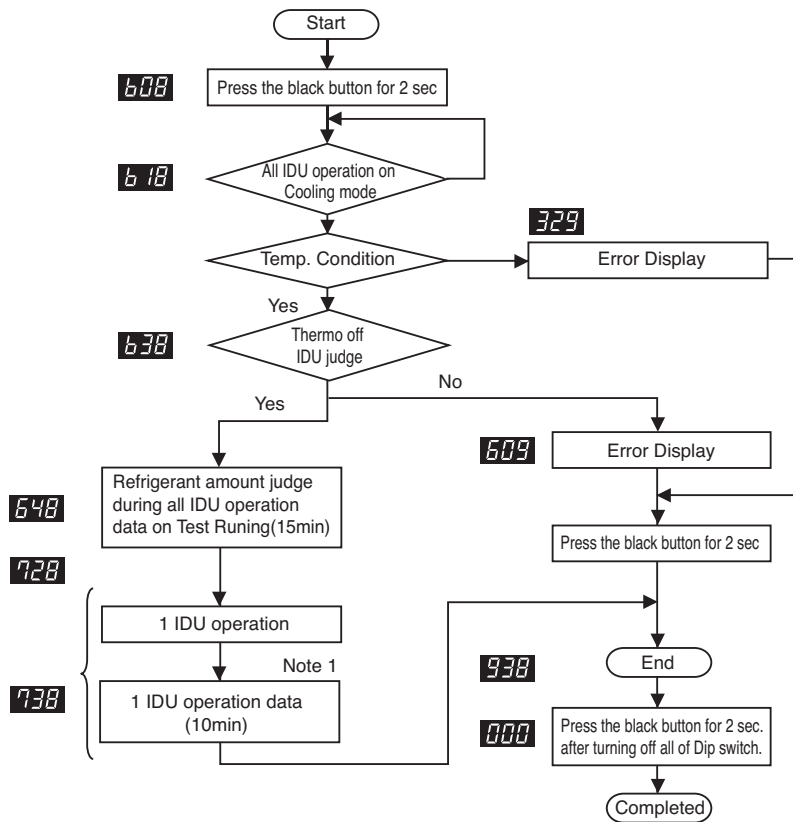

DIP Switch Settings

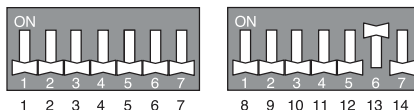

Warning : Please reset Main PCB before starting this function

Note

1. Judge the normal condition refer to report of Test Running.

Integrated Test Running Function_Heating Mode (Setting 4)

This function is checking process for normal operation of parts and system On operating system.

- All processes carry out included refrigerant amount judge logic and check normal condition of parts on heating mode.
- This function check only normal condition of parts on heating mode.
- Saved data can check using LGMV.

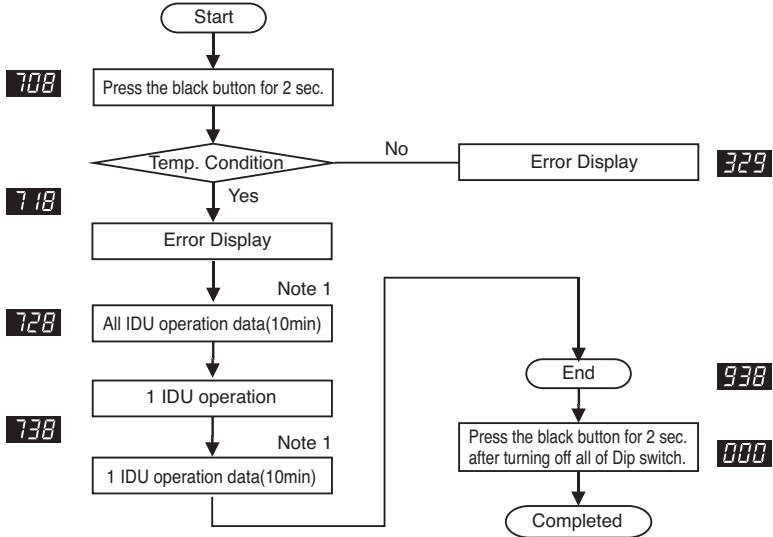

DIP Switch Settings

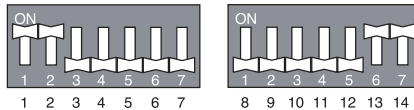

Warning : Please reset Main PCB before starting this function

Note

1. Judge the normal condition refer to report of Test Running.

Night Silent Operation

In cooling mode, this function makes the ODU fan operate at low RPM to reduce the fan noise of ODU at night which has low cooling load.

Max. RPM setting method

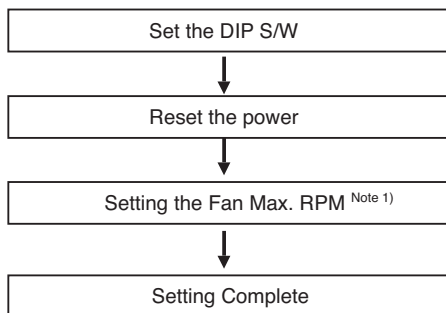

Note 1)

Setting Method for Fan Max. RPM

Step	Black Button	Red Button
1	1 time	1 time
2	2 time	1 time
3	3 time	1 time
4	4 time	1 time
5	5 time	1 time
6	6 time	1 time
7	7 time	1 time
8	8 time	1 time
9	9 time	1 time

RPM / Time Settings

Capacity (Hp)	Capacity		Judgment Time(Hr)	Operation Time(Hr)	
	8	10~14			
Step	Fan Maximum RPM				
1	①	790	900	8	9
2				6.5	10.5
3				5	12
4	②	680	800	8	9
5				6.5	10.5
6				5	12
7	③	620	780	8	9
8				6.5	10.5
9				5	12

Noise

Capacity(HP)	Capacity	
	8	10~14
Step	Max. RPM Noise(dB)	
Standard	58	62
①	55	59
②	52	56
③	49	53

DIP Switch Settings

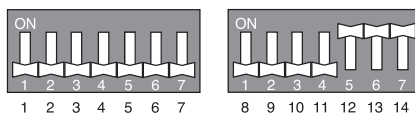

Warning : Please reset Main PCB before starting this function

CAUTION

1. Request installer to set the function during installation.
2. In case the function is not used, set the dip S/W OFF and reset the power.
3. If ODU RPM changes, cooling capacity may go down.

Vacuum Mode

This function is used for creating vacuum in the system after compressor replacement, ODU parts replacement or IDU addition/replacement.

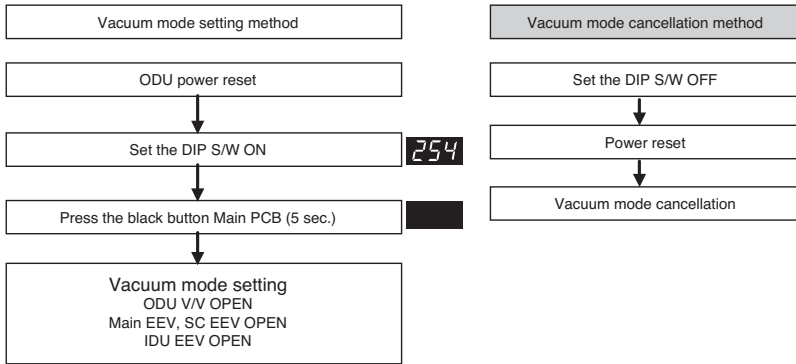

DIP Switch Settings

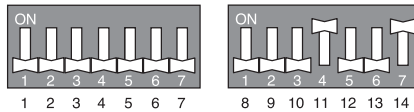

Warning : Please reset Main PCB before starting this function



CAUTION

ODU operation stops during vacuum mode.

Static pressure compensation mode

This function secures the air flow rate of ODU, in case static pressure has been applied like using duct at fan discharge of ODU.

■ Static pressure compensation dip S/W setting method

High static pressure mode : Set DIP S/W

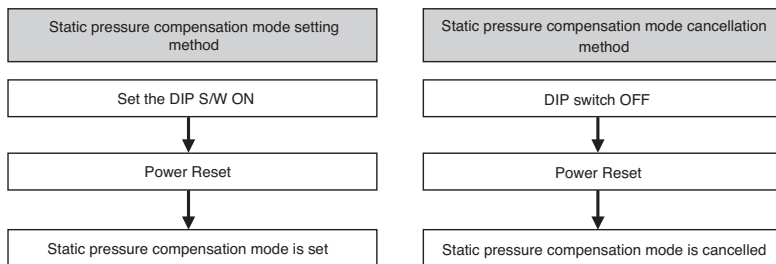

DIP Switch Settings

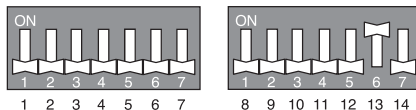

Warning : Please reset Main PCB before starting this function

Note

How to set the unit to high ESP :

- 1) Standard ESP (External Static Pressure) : 4mmH₂O (39.2Pa)
- 2) High ESP (External Static Pressure) : 8mmH₂O (78.4Pa)
 - The setting of dip S/W is needed. (Refer to above operating method)

Self-Diagnosis Function

Error Indicator

- This function indicates types of failure in self-diagnosis and occurrence of failure for air condition.
- Error mark is displayed on display window of indoor units and wired remote controller, and 7-segment LED of outdoor unit control board as shown in the table.
- If more than two troubles occur simultaneously, lower number of error code is first displayed.
- After error occurrence, if error is released, error LED is also released simultaneously.

Error Display

1st,2nd LED of 7-segment indicates error number, 3rd LED indicates unit number.

- Ex) 211 : No.21 error of master unit
 213 : No.21 error of slave2
 011 → 051 : No.105 error of master unit

※ Refer to the DX-Ventilation manual for DX-Ventilation error code

Display			Title	Cause of Error	
Indoor unit related error	0	1	-	Air temperature sensor of indoor unit	Air temperature sensor of indoor unit is open or short
	0	2	-	Inlet pipe temperature sensor of indoor unit	Inlet pipe temperature sensor of indoor unit is open or short
	0	3	-	Communication error : wired remote controller ↔ indoor unit	Failing to receive wired remote controller signal in indoor unit PCB
	0	4	-	Drain pump	Malfunction of drain pump
	0	5	-	Communication error : outdoor unit ↔ indoor unit	Failing to receive outdoor unit signal in indoor unit PCB
	0	6	-	Outlet pipe temperature sensor of indoor unit	Outlet pipe temperature sensor of indoor unit is open or short
	0	9	-	Indoor EEPROM Error	In case when the serial number marked on EEPROM of Indoor unit is 0 or FFFFFFFF
	1	0	-	Poor fan motor operation	Disconnecting the fan motor connector/Failure of indoor fan motor lock
	1	7	-	Inlet Air temperature sensor of FAU	Air temperature sensor of indoor unit is open or short
Outdoor unit related error	2	1	1	Master Outdoor Unit Inverter Compressor IPM Fault	Master Outdoor Unit Inverter Compressor Drive IPM Fault
			2	Slave1 Outdoor Unit Inverter Compressor IPM Fault	Slave1 Outdoor Unit Inverter Compressor Drive IPM Fault
			3	Slave2 Outdoor Unit Inverter Compressor IPM Fault	Slave2 Outdoor Unit Inverter Compressor Drive IPM Fault
	2	2	1	Inverter Board Input Over Current(RMS) of Master Outdoor Unit	Master Outdoor Unit Inverter Board Input Current excess (RMS)
			2	Inverter Board Input Over Current(RMS) of Slave1 Outdoor Unit	Slave1 Outdoor Unit Inverter Board Input Current excess (RMS)
			3	Inverter Board Input Over Current(RMS) of Slave2 Outdoor Unit	Slave2 Outdoor Unit Inverter Board Input Current excess (RMS)

		Display	Title	Cause of Error
Outdoor unit related error	2	3	1 Master Outdoor Unit Inverter Compressor DC link Low Voltage	DC charging is not performed at Master Outdoor Unit after starting relay turn on.
			2 Slave1 Outdoor Unit Inverter Compressor DC link Low Voltage	DC charging is not performed at Slave1 Outdoor Unit after starting relay turn on.
			3 Slave2 Outdoor Unit Inverter Compressor DC link Low Voltage	DC charging is not performed at Slave2 Outdoor Unit after starting relay turn on.
	2	4	1 Master Outdoor Unit High Pressure Switch	System is turned off by Master Outdoor Unit high pressure switch.
			2 Slave1 Outdoor Unit High Pressure Switch	System is turned off by slave1 Outdoor Unit high pressure switch.
			3 Slave2 Outdoor Unit High Pressure Switch	System is turned off by slave2 Outdoor Unit high pressure switch.
	2	5	1 Master Outdoor Unit Input Voltage High/ Low Voltage	Master Outdoor Unit(208/230V) input voltage is over 300V or below 140V Master Outdoor Unit(460V) input voltage is over 487V or below 270V
			2 Slave1 Outdoor Unit Input Voltage High/ Low Voltage	Slave1 Outdoor Unit(208/230V) input voltage is over 300V or below 140V Slave1 Outdoor Unit(460V) input voltage is over 487V or below 270V
			3 Slave2 Outdoor Unit Input Voltage High/ Low Voltage	Slave2 Outdoor Unit(208/230V) input voltage is over 300V or below 140V Slave2 Outdoor Unit(460V) input voltage is over 487V or below 270V
	2	6	1 Master Outdoor Unit Inverter Compressor Start Failure	The First Start Failure by Master Outdoor Unit Inverter Compressor Abnormality
			2 Slave1 Outdoor Unit Inverter Compressor Start Failure	The First Start Failure by Slave1 Outdoor Unit Inverter Compressor Abnormality
			3 Slave2 Outdoor Unit Inverter Compressor Start Failure	The First Start Failure by Slave2 Outdoor Unit Inverter Compressor Abnormality
	2	8	1 Master Outdoor Unit Inverter DC link High Voltage	System is turned off by Master Outdoor Unit DC Voltage Over Charging
			2 Slave1 Outdoor Unit Inverter DC link High Voltage	System is turned off by Slave1 Outdoor Unit DC Voltage Over Charging
			3 Slave2 Outdoor Unit Inverter DC link High Voltage	System is turned off by Slave2 Outdoor Unit DC Voltage Over Charging
	2	9	1 Master Outdoor Unit Inverter Compressor Over Current	Master Outdoor Unit Inverter Compressor Fault OR Drive Fault
			2 Slave1 Outdoor Unit Inverter Compressor Over Current	Slave1 Outdoor Unit Inverter Compressor Fault OR Drive Fault
			3 Slave2 Outdoor Unit Inverter Compressor Over Current	Slave2 Outdoor Unit Inverter Compressor Fault OR Drive Fault
	3	0	1 Master Outdoor Unit Constant Speed Compressor2 High Discharge Temperature	System is turned off by Master Outdoor Unit Constant Speed Compressor2 High Discharge Temperature
			2 Slave1 Outdoor Unit Constant Speed Compressor2 High Discharge Temperature	System is turned off by Slave1 Outdoor Unit Constant Speed Compressor2 High Discharge Temperature
			3 Slave2 Outdoor Unit Constant Speed Compressor2 High Discharge Temperature	System is turned off by Slave2 Outdoor Unit Constant Speed Compressor2 High Discharge Temperature
	3	2	1 Master Outdoor Unit Inverter Compressor High Discharge Temperature	System is turned off by Master Outdoor Unit Inverter Compressor High Discharge Temperature
			2 Slave1 Outdoor Unit Inverter Compressor High Discharge Temperature	System is turned off by Slave1 Outdoor Unit Inverter Compressor High Discharge Temperature
			3 Slave2 Outdoor Unit Inverter Compressor High Discharge Temperature	System is turned off by Slave2 Outdoor Unit Inverter Compressor High Discharge Temperature

		Display	Title	Cause of Error	
Outdoor unit related error	3	3	1	Master Outdoor Unit Constant Speed Compressor1 High Discharge Temperature	System is turned off by Master Outdoor Unit Constant Speed Compressor1 High Discharge Temperature
			2	Slave1 Outdoor Unit Constant Speed Compressor1 High Discharge Temperature	System is turned off by Slave1 Outdoor Unit Constant Speed Compressor1 High Discharge Temperature
			3	Slave2 Outdoor Unit Constant Speed Compressor1 High Discharge Temperature	System is turned off by Slave2 Outdoor Unit Constant Speed Compressor1 High Discharge Temperature
	3	4	1	High Pressure of Master Outdoor Unit	System is turned off by excessive increase of high pressure of Master Outdoor Unit
			2	High Pressure of Slave1 Outdoor Unit	System is turned off by excessive increase of high pressure of Slave1 Outdoor Unit
			3	High Pressure of Slave2 Outdoor Unit	System is turned off by excessive increase of high pressure of Slave2 Outdoor Unit
	3	5	1	Low Pressure of Master Outdoor Unit	System is turned off by excessive decrease of low pressure of Master Outdoor Unit
			2	Low Pressure of Slave1 Outdoor Unit	System is turned off by excessive decrease of low pressure of Slave1 Outdoor Unit
			3	Low Pressure of Slave2 Outdoor Unit	System is turned off by excessive decrease of low pressure of Slave2 Outdoor Unit
	3	6	1	Master Outdoor Unit Low Condensing Ratio Limited	Master Outdoor Unit stayed under low condensing limit for 3 minutes
			2	Slave1 Outdoor Unit Low Condensing Ratio Limited	Slave1 Outdoor Unit stayed under low condensing limit for 3 minutes
			3	Slave2 Outdoor Unit Low Condensing Ratio Limited	Slave2 Outdoor Unit stayed under low condensing limit for 3 minutes
	4	0	1	Master Outdoor Unit Inverter Compressor CT Sensor Fault	Master Outdoor Unit Inverter Compressor CT Sensor open or short
			2	Slave1 Outdoor Unit Inverter Compressor CT Sensor Fault	Slave1 Outdoor Unit Inverter Compressor CT Sensor open or short
			3	Slave2 Outdoor Unit Inverter Compressor CT Sensor Fault	Slave2 Outdoor Unit Inverter Compressor CT Sensor open or short
	4	1	1	Master Outdoor Unit Inverter Compressor Discharge Temperature Sensor Fault	Master Outdoor Unit Inverter Compressor Discharge Temperature Sensor open or short
			2	Slave1 Outdoor Unit Inverter Compressor Discharge Temperature Sensor Fault	Slave1 Outdoor Unit Inverter Compressor Discharge Temperature Sensor open or short
			3	Slave2 Outdoor Unit Inverter Compressor Discharge Temperature Sensor Fault	Slave2 Outdoor Unit Inverter Compressor Discharge Temperature Sensor open or short
	4	2	1	Master Outdoor Unit Low Pressure Sensor Fault	Master Outdoor Unit Low Pressure Sensor open or short
			2	Slave1 Outdoor Unit Low Pressure Sensor Fault	Slave1 Outdoor Unit Low Pressure Sensor open or short
			3	Slave2 Outdoor Unit Low Pressure Sensor Fault	Slave2 Outdoor Unit Low Pressure Sensor open or short
	4	3	1	Master Outdoor Unit High Pressure Sensor Fault	Master Outdoor Unit High Pressure Sensor open or short
			2	Slave1 Outdoor Unit High Pressure Sensor Fault	Slave1 Outdoor Unit High Pressure Sensor open or short
			3	Slave2 Outdoor Unit High Pressure Sensor Fault	Slave2 Outdoor Unit High Pressure Sensor open or short

		Display	Title	Cause of Error	
Outdoor unit related error	4	4	1	Master Outdoor Unit Air Temperature Sensor Fault	Master Outdoor Unit Air Temperature Sensor open or short
			2	Slave1 Outdoor Unit Air Temperature Sensor Fault	Slave1 Outdoor Unit Air Temperature Sensor open or short
			3	Slave2 Outdoor Unit Air Temperature Sensor Fault	Slave2 Outdoor Unit Air Temperature Sensor open or short
	4	5	1	Master Outdoor Unit Heat Exchanger Temperature Sensor (Front side) Fault	Master Outdoor Unit Heat Exchanger Temperature Sensor(Front side) open or short
			2	Slave1 Outdoor Unit Heat Exchanger Temperature Sensor (Front side) Fault	Slave1 Outdoor Unit Heat Exchanger Temperature Sensor (Front side) open or short
			3	Slave2 Outdoor Unit Heat Exchanger Temperature Sensor (Front side) Fault	Slave2 Outdoor Unit Heat Exchanger Temperature Sensor(Front side) open or short
	4	6	1	Master Outdoor Unit Suction Temperature Sensor Fault	Master Outdoor Unit Suction Temperature Sensor open or short
			2	Slave1 Outdoor Unit Suction Temperature Sensor Fault	Slave1 Outdoor Unit Suction Temperature Sensor open or short
			3	Slave2 Outdoor Unit Suction Temperature Sensor Fault	Slave2 Outdoor Unit Suction Temperature Sensor open or short
	4	7	1	Master Outdoor Unit Constant Speed Compressor1 Discharge Temperature Sensor Fault	Master Outdoor Unit Constant Speed Compressor1 Discharge Temperature Sensor open or short
			2	Slave1 Outdoor Unit Constant Speed Compressor1 Discharge Temperature Sensor Fault	Slave1 Outdoor Unit Constant Speed Compressor1 Discharge Temperature Sensor open or short
			3	Slave2 Outdoor Unit Constant Speed Compressor1 Discharge Temperature Sensor Fault	Slave2 Outdoor Unit Constant Speed Compressor1 Discharge Temperature Sensor open or short
	4	8	1	Master Outdoor Unit Constant Speed Compressor2 Discharge Temperature Sensor Fault	Master Outdoor Unit Constant Speed Compressor 2 Discharge Temperature Sensor open or short
			2	Slave1 Outdoor Unit Constant Speed Compressor2 Discharge Temperature Sensor Fault	Slave1 Outdoor Unit Constant Speed Compressor 2 Discharge Temperature Sensor open or short
			3	Slave2 Outdoor Unit Constant Speed Compressor2 Discharge Temperature Sensor Fault	Slave2 Outdoor Unit Constant Speed Compressor 2 Discharge Temperature Sensor open or short
	4	9	1	Master Outdoor Unit Faulty IPM Temperature Sensor	Master Outdoor Unit IPM Temperature Sensor short/open
			2	Slave1 Outdoor Unit Faulty IPM Temperature Sensor	Slave1 Outdoor Unit IPM Temperature Sensor short/open
			3	Slave2 Outdoor Unit Faulty IPM Temperature Sensor	Slave2 Outdoor Unit IPM Temperature Sensor short/open

		Display	Title	Cause of Error	
Outdoor unit related error	5	0	1	Omitting connection of R, S, T power of Master Outdoor Unit	Omitting connection of Master outdoor unit
			2	Omitting connection of R, S, T power of Slave1 Outdoor Unit	Omitting connection of Slave1 Outdoor Unit
			3	Omitting connection of R, S, T power of Slave2 Outdoor Unit	Omitting connection of Slave2 Outdoor Unit
	5	1	1	Excessive capacity of indoor units	Excessive connection of indoor units compared to capacity of Outdoor Unit
	5	2	1	Transmission error : inverter PCB → Main PCB	Failing to receive inverter signal at main PCB of Master Outdoor Unit
			2	Transmission error : inverter PCB → Main PCB	Failing to receive inverter signal at main PCB of Slave1 Outdoor Unit
			3	Transmission error : inverter PCB → Main PCB	Failing to receive inverter signal at main PCB of Slave2 Outdoor Unit
	5	3	1	Transmission error : indoor unit → main PCB of Outdoor Unit	Failing to receive indoor unit signal at main PCB of Outdoor Unit .
	5	4	1	Reverse connection of R, S, T power of Master Outdoor Unit	Reverse connection or omitting connection of R, S, T power of Master Outdoor Unit
			2	Reverse connection of R, S, T power of Slave1 Outdoor Unit	Reverse connection or omitting connection of R, S, T power of Slave1 Outdoor Unit
			3	Reverse connection of R, S, T power of Slave2 Outdoor Unit	Reverse connection or omitting connection of R, S, T power of Slave2 Outdoor Unit
	5	7	1	Master Outdoor Unit Communication Error with Inverter Controller	Master Outdoor Unit Controller part cannot receive inverter control signals (usually happens after on-boarding)
			2	Slave1 Outdoor Unit Communication Error with Inverter Controller	Slave1 Outdoor Unit Controller part cannot receive inverter control signals (usually happens after on-boarding)
			3	Slave2 Outdoor Unit Communication Error with Inverter Controller	Slave2 Outdoor Unit Controller part cannot receive inverter control signals (usually happens after on-boarding)
	5	9	1	Error of series installation	In the case of installing smaller outdoor unit as master unit
	6	0	1	Inverter PCB EEPROM Error of Master Outdoor Unit	Access Error of Inverter PCB of Master Outdoor Unit
			2	Inverter PCB EEPROM Error of Slave1 Unit	Access Error of Inverter PCB of Slave1 Outdoor Unit
			3	Inverter PCB EEPROM Error of Slave2 Unit	Access Error of Inverter PCB of Slave2 Outdoor Unit
	6	7	1	Master Outdoor Unit Fan Lock	Restriction of Master Outdoor Unit
			2	Slave1 Outdoor Unit Fan Lock	Restriction of Slave1 Outdoor Unit
			3	Slave2 Outdoor Unit Fan Lock	Restriction of Slave2 Outdoor Unit
6	9	1	Constant1 CT Sensor Error of Master Outdoor Unit	Constant1 CT Sensor open or short of Master Outdoor Unit	
		2	Constant1 CT Sensor Error of Slave1 Outdoor Unit	Constant1 CT Sensor open or short of Slave1 Outdoor Unit	
		3	Constant1 CT Sensor Error of Slave2 Outdoor Unit	Constant1 CT Sensor open or short of Slave2 Outdoor Unit	

		Display	Title	Cause of Error	
Outdoor unit related error	7	0	1	Constant2 CT Sensor Error of Master Outdoor Unit	Constant2 CT Sensor open or short of Master Outdoor Unit
			2	Constant2 CT Sensor Error of Slave1 Outdoor Unit	Constant2 CT Sensor open or short of Slave1 Outdoor Unit
			3	Constant2 CT Sensor Error of Slave2 Outdoor Unit	Constant2 CT Sensor open or short of Slave2 Outdoor Unit
	7	3	1	Instant Over Current(Peak) of Master Outdoor Unit PFC	Instant Over Current(Peak) of Master Outdoor Unit PFC
			2	Instant Over Current(Peak) of Slave1 Outdoor Unit PFC	Instant Over Current(Peak) of Slave1 Outdoor Unit PFC
			3	Instant Over Current(Peak) of Slave2 Outdoor Unit PFC	Instant Over Current(Peak) of Slave2 Outdoor Unit PFC
	7	5	1	Master Outdoor Unit Fan CT Sensor Error	Master Outdoor Unit Fan CT Sensor open or short
			2	Slave1 Outdoor Unit Fan CT Sensor Error	Slave1 Outdoor Unit Fan CT Sensor open or short
			3	Slave2 Outdoor Unit Fan CT Sensor Error	Slave2 Outdoor Unit Fan CT Sensor open or short
	7	6	1	Master Outdoor Unit Fan DC Link High Voltage Error	Master Outdoor Unit Fan DC Link High Voltage Error
			2	Slave1 Outdoor Unit Fan DC Link High Voltage Error	Slave1 Outdoor Unit Fan DC Link High Voltage Error
			3	Slave2 Outdoor Unit Fan DC Link High Voltage Error	Slave2 Outdoor Unit Fan DC Link High Voltage Error
	7	7	1	Master Outdoor Unit Fan Over Current Error	Master Outdoor Unit Fan Current is over 10A
			2	Slave1 Outdoor Unit Fan Over Current Error	Slave1 Outdoor Unit Fan is over 10A
			3	Slave2 Outdoor Unit Fan Over Current Error	Slave2 Outdoor Unit Fan is over 10A
	7	9	1	Master Outdoor Unit Fan Start Failure Error	Master Outdoor Unit Fan First Position Sensing Failure
			2	Slave1 Outdoor Unit Fan Start Failure Error	Slave1 Outdoor Unit Fan First Position Sensing Failure
			3	Slave2 Outdoor Unit Fan Start Failure Error	Slave2 Outdoor Unit Fan First Position Sensing Failure
	8	6	1	Master Outdoor Unit Main PCB EEPROM Error	Communication Fail Between Master Outdoor Unit Main MICOM and EEPROM or omitting EEPROM
			2	Slave1 Outdoor Unit Main PCB EEPROM Error	Communication Fail Between Slave1 Outdoor Unit Main MICOM and EEPROM or omitting EEPROM
			3	Slave2 Outdoor Unit Main PCB EEPROM Error	Communication Fail Between Slave2 Outdoor Unit Main MICOM and EEPROM or omitting EEPROM
8	7	1	Master Outdoor Unit Fan PCB EEPROM Error	Communication Fail Between Master Outdoor Unit Fan MICOM and EEPROM or omitting EEPROM	
		2	Slave1 Outdoor Unit Fan PCB EEPROM Error	Communication Fail Between Slave1 Outdoor Unit Fan MICOM and EEPROM or omitting EEPROM	
		3	Slave2 Outdoor Unit Fan PCB EEPROM Error	Communication Fail Between Slave2 Outdoor Unit Fan MICOM and EEPROM or omitting EEPROM	

		Display	Title	Cause of Error		
Outdoor unit related error	1	0	4	1	Communication Error Between Master Outdoor Unit and Other Outdoor Unit	Failing to receive Slave Unit signal at main PCB of Master Outdoor Unit
				2	Communication Error Between Slave1 Outdoor Unit and Other Outdoor Unit	Failing to receive master and other Slave Unit signal at main PCB of Slave1 Outdoor Unit
				3	Communication Error Between Slave2 Outdoor Unit and Other Outdoor Unit	Failing to receive master and other Slave Unit signal at main PCB of Slave2 Outdoor Unit
	1	0	5	1	Master Outdoor Unit Fan PCB Communication Error	Failing to receive fan signal at main PCB of master unit.
				2	Slave1 Outdoor Unit Fan PCB Communication Error	Failing to receive fan signal at main PCB of Slave1 unit.
				3	Slave2 Outdoor Unit Fan PCB Communication Error	Failing to receive fan signal at main PCB of Slave2 unit.
	1	0	6	1	Master Outdoor Unit FAN IPM Fault Error	Instant Over Current at Master Outdoor Unit Fan IPM
				2	Slave1 Outdoor Unit FAN IPM Fault Error	Instant Over Current at Slave1 Outdoor Unit Fan IPM
				3	Slave2 Outdoor Unit FAN IPM Fault Error	Instant Over Current at Slave2 Outdoor Unit Fan IPM
	1	0	7	1	Master Outdoor Unit Fan DC Link Low Voltage Error	Master Outdoor Unit(208/230V) Fan DC Link Input Voltage is under 140V Master Outdoor Unit(460V) Fan DC Link Input Voltage is under 380V
				2	Slave1 Outdoor Unit Fan DC Link Low Voltage Error	Slave1 Outdoor Unit(208/230V) Fan DC Link Input Voltage is under 140V Slave1 Outdoor Unit(460V) Fan DC Link Input Voltage is under 380V
				3	Slave2 Outdoor Unit Fan DC Link Low Voltage Error	Slave2 Outdoor Unit(208/230V) Fan DC Link Input Voltage is under 140V Slave2 Outdoor Unit(460V) Fan DC Link Input Voltage is under 380V
	1	1	3	1	Master Outdoor Unit Liquid pipe Temperature Sensor Error	Liquid pipe temperature sensor of Master Outdoor Unit is open or short
				2	Slave1 Outdoor Unit Liquid pipe Temperature Sensor Error	Liquid pipe temperature sensor of slave1 Outdoor Unit is open or short
				3	Slave2 Outdoor Unit Liquid pipe Temperature Sensor Error	Liquid pipe temperature sensor of slave2 Outdoor Unit is open or short
	1	1	5	1	Master Outdoor Unit Subcooling Outlet Temperature Sensor Error	Master Outdoor Unit Subcooling Outlet Temperature Sensor open or short
				2	Slave1 Outdoor Unit Subcooling Outlet Temperature Sensor Error	Slave1 Outdoor Unit Subcooling Outlet Temperature Sensor open or short
				3	Slave2 Outdoor Unit Subcooling Outlet Temperature Sensor Error	Slave2 Outdoor Unit Subcooling Outlet Temperature Sensor open or short
	1	5	1	1	Failure of operation mode conversion at Master Outdoor Unit	Pressure unbalance between Outdoor Units
				2	Failure of operation mode conversion at Slave1 Outdoor Unit	Pressure unbalance between Outdoor Units
				3	Failure of operation mode conversion at Slave2 Outdoor Unit	Pressure unbalance between Outdoor Units

			Display	Title	Cause of Error	
Outdoor unit related error	1	7	3	1	Master Outdoor Unit Constant Speed Compressor Fault	Comp locking, Check Valve leakage, comp dielectric break down at Master Outdoor Unit
				2	Slave1 Outdoor Unit Constant Speed Compressor Fault	Comp locking, Check Valve leakage, comp dielectric at Slave1 Outdoor Unit
				3	Slave2 Outdoor Unit Constant Speed Compressor Fault	Comp locking, Check Valve leakage, comp dielectric at Slave2 Outdoor Unit
	1	7	4	1	Master outdoor unit rated speed 2 condenser over-current	Master Outdoor Unit rated speed 2 condenser burned / locked or fault by over-current
				2	Slave1 outdoor unit rated speed 2 condenser over-current	Slave1 Outdoor Unit rated speed 2 condenser burned / locked or fault by over-current
				3	Slave2 outdoor unit rated speed 2 condenser over-current	Slave2 Outdoor Unit rated speed 2 condenser burned / locked or fault by over-current
	1	8	2	1	Master outdoor unit Main Board Main-Sub Micom communication error	Master Outdoor Unit Main Board Main-Sub Micom communication failed
				2	Slave1 outdoor unit Main Board Main-Sub Micom communication error	Slave1 Outdoor Unit Main Board Main-Sub Micom communication failed
				3	Slave2 outdoor unit Main Board Main-Sub Micom communication error	Slave2 Outdoor Unit Main Board Main-Sub Micom communication failed
	1	9	3	1	Excessive increase of Master Outdoor Unit Fan PCB Heat Sink Temperature	Master Outdoor Unit Fan Inverter PCB Temperature is Over 95°C
				2	Excessive increase of Slave1 Outdoor Unit Fan PCB Heat Sink Temperature	Slave1 Outdoor Unit Fan Inverter PCB Temperature is Over 95°C
				3	Excessive increase of Slave2 Outdoor Unit Fan PCB Heat Sink Temperature	Slave2 Outdoor Unit Fan Inverter PCB Temperature is Over 95°C
	1	9	4	1	Master Outdoor Unit Fan PCB Heat Sink Temperature Sensor Error	Master Outdoor Unit Fan PCB Heat Sink Temperature Sensor open or short
				2	Slave1 Outdoor Unit Fan PCB Heat Sink Temperature Sensor Error	Slave1 Outdoor Unit Fan PCB Heat Sink Temperature Sensor open or short
				3	Slave2 Outdoor Unit Fan PCB Heat Sink Temperature Sensor Error	Slave2 Outdoor Unit Fan PCB Heat Sink Temperature Sensor open or short

New Function

■ Multi V III provides as following new functions.

New Function		Applied item
Cool/Heat selector (PRDSBM)	Cooling/ Heating/ Fan Cooling/ Heating/ All OFF	ODU Solution Accessory
ODU Dry contact (PQDSBDCVM0)	Demand control -. Low load operation -. DDC control (DC0~10V Input)	ODU Solution Accessory
	ODU Fan Low speed control (Night low noise operation)	
	Error alarm	

* If you want to get more details, refer to each installation Manuals.

■ Out Feature

- Cool/ Heat Selector

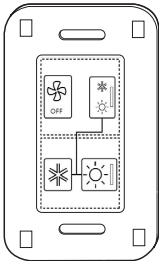

- ODU Dry contact

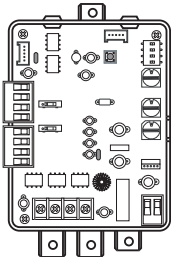

1. Cool/ Heat selector

Cool/ Heat Selector has provided two different functions.

- Cooling/ heating/ Fan lock mode
- Cooling/ heating/ All OFF mode

[Installation]

1. Check the contents of Cool/ Heat Selector



<Outdoor Dry Contact Main Body>



<Front Case>

2. Connect Outdoor Main PCB and Cool/ Heat Selector.

- Connect terminals on the back side of Cool/Heat Selector to terminal of Outdoor as show

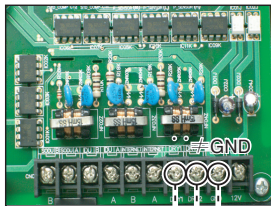

< Outdoor Main PCB >

..... shows field wiring

———— connected wiring

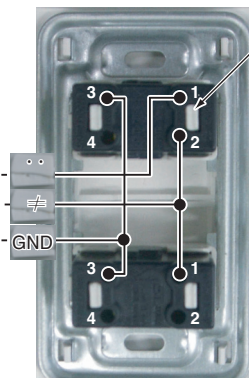

<Outdoor Dry Contact Back Side >

Push Button

- Insert wire method -



Push arrow direction.



Insert wire to connector.

* Communication line length can be maximum 300m, use communication line as thick as 1.25mm².

[setting]

1. Set DIP S/W according to DIP S/W setting table.(5,6,11,12)
2. Push Black button on SVC PCB
3. Select number as below at 7-segment
 "0" : Cooling/ Heating / Fan lock mode
 "1" : Cooling/ Heating/ All OFF Mode
4. After Selecting, DIP S/W OFF(11,12)

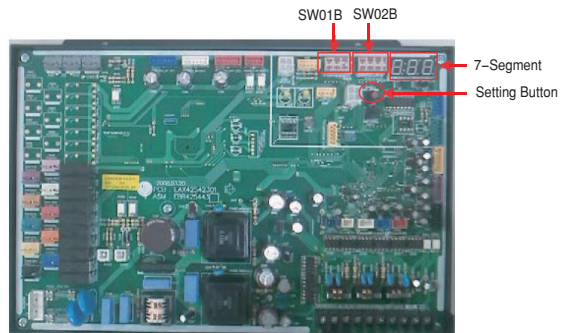

2. ODU Dry contact

ODU Dry contact has provided Three different functions.

- Demand control
- Night Low Noise control
- Error Alarm Monitoring function

[ODU Dry contact]

- Feature and Parts Naming

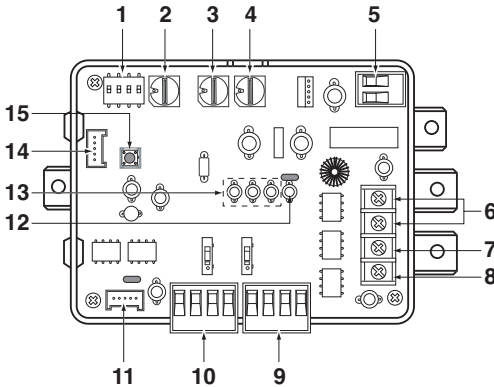

1. SWDIP : Switch to select main function
2. SW_Address2 : Switch to set a upper address of the outdoor unit
3. SW_Address1 : Switch to set a lower address of the outdoor unit
4. SW_STEP : Switch to select a control mode.
5. CN_PWR : DC Input terminal
6. ERROR : Error display with relay contact
7. BUS-A : RS-485 (+) Terminal
8. BUS-B : RS-485 (-) Terminal
9. CN_CAPACITY : Signal input terminal to control a capacity of outdoor unit
10. CN_SPEED/CAP : Signal input terminal for Analog Input/Low noise operation
11. CN_OUT : Outdoor unit connector
12. LED1 : Display LED for RS-485 status
13. LED01G,02G,03G : Display LED for communication status
14. CN_JIG : Connector for writing program
15. SW1 : Reset switch

- Installation

1. ODU Dry contact single installation : Connect with ODU both single Unit and Series.

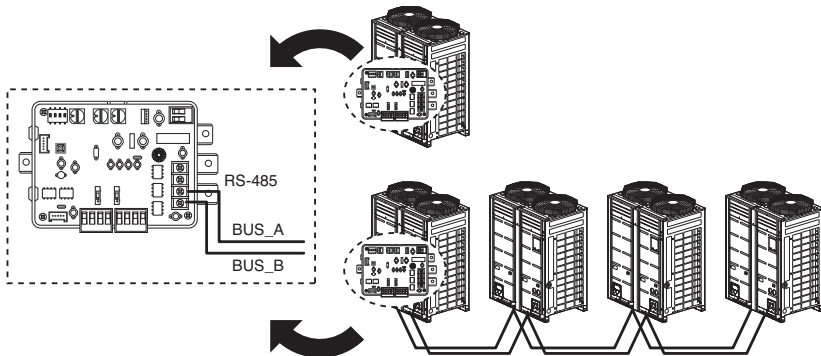

2. ODU Dry contact with Central controller
: With Single Outdoor unit

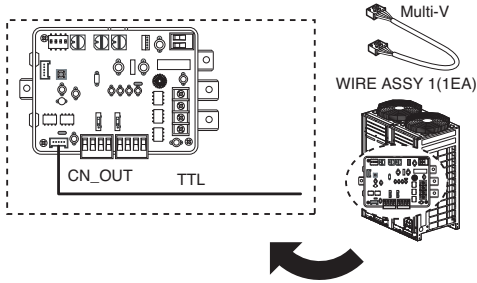

: With Series Outdoor units

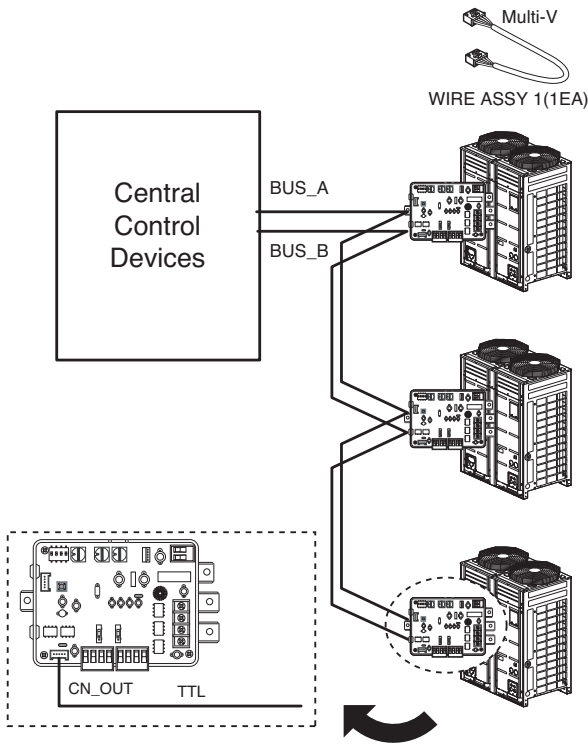

2.1 Demand Control

ODU Dry contact has provided Two different methods for Demand control

- Using Contact signal
 - : High/ Low pressure value s are changed by setting value of Rotary S/W
- Using Analog signal with DDC Module
 - : High/ Low pressure value s are changed by setting value of DDC Module.(DC 0~10V)

[Rotary S/W setting]

SW_STEP	Input Signal
0, 1, 2, 3, 4, 5, 6	Contact signal
D, E	Analog signal

[Setting]

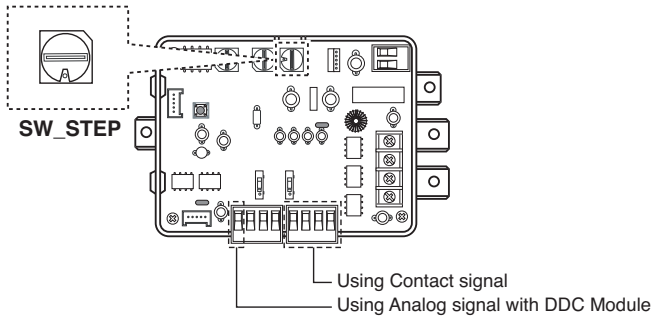

- Each connecting methods

1. Using Contact signal

<Without External power source>

<With External power source>

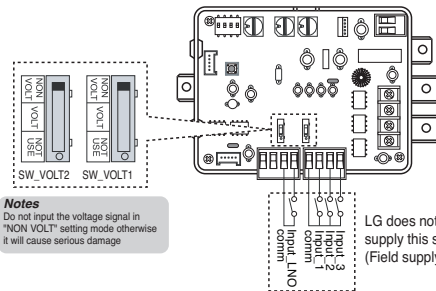

Notes
Do not input the voltage signal in "NON VOLT" setting mode otherwise it will cause serious damage

LG does not supply this section (Field supply)

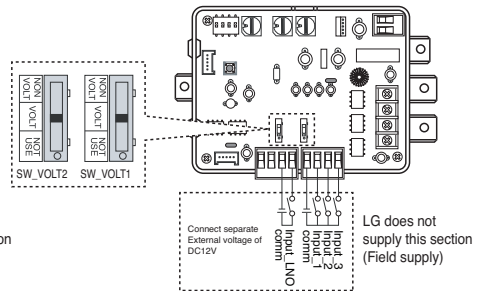

Connect separate External voltage of DC12V

LG does not supply this section (Field supply)

2. Using Analog signal with DDC Module

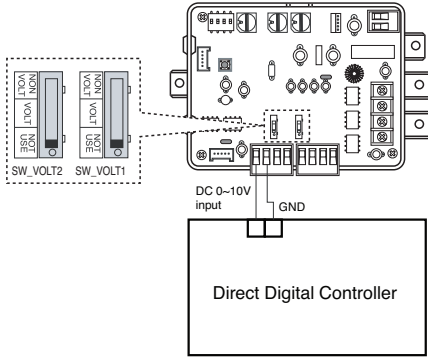

[Control Value]

- Using Contact signal

Rotary S/W	Volt	Cooling		Heating	
		Step	Control	Step	Control
D	0	0	Not-Control	0	Not-Control
	1	1	100%	0	100%
	2	2	90%	0	90%
	3	3	80%	0	80%
	4	4	70%	0	70%
	5	5	60%	0	60%
	6	6	50%	0	50%
	7	7	45%	0	45%
	8	8	40%	0	40%
	9	9	Comp OFF	0	Comp OFF
10	10	All OFF	0	All OFF	

Rotary S/W	Volt	Cooling		Heating	
		Step	Control	Step	Control
E	0	9	Comp OFF	0	Comp OFF
	1	8	40%	0	40%
	2	7	45%	0	45%
	3	6	52%	0	50%
	4	5	60%	0	60%
	5	4	70%	0	70%
	6	3	80%	0	80%
	7	2	90%	0	90%
	8	1	100%	0	100%
	9	1	100%	0	100%
10	1	100%	0	100%	

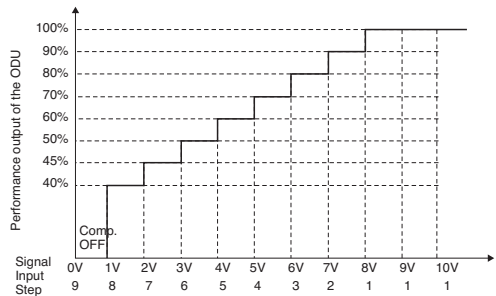
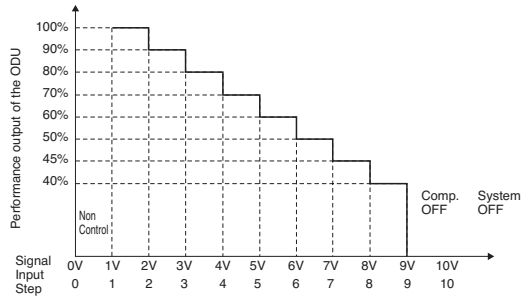

New Function

- Using Analog signal with DDC Module

SW_STEP	Input_1	Input_2	Input_3	Comp capacity Of outdoor unit(%)
0	0	0	0	No control
	1	0	0	70
	0	1	0	40
	0	0	1	COMP OFF
1	0	0	0	No control
	1	0	0	70
	0	1	0	50
	0	0	1	COMP OFF
2	0	0	0	No control
	1	0	0	80
	0	1	0	50
	0	0	1	COMP OFF
3	0	0	0	No control
	1	0	0	70
	0	1	0	40
	0	0	1	ALL OFF
4	0	0	0	No control
	1	0	0	70
	0	1	0	50
	0	0	1	ALL OFF
5	0	0	0	No control
	1	0	0	80
	0	1	0	50
	0	0	1	ALL OFF
6	0	0	0	No control
	1	0	0	50
	0	1	0	COMP OFF
	0	0	1	ALL OFF

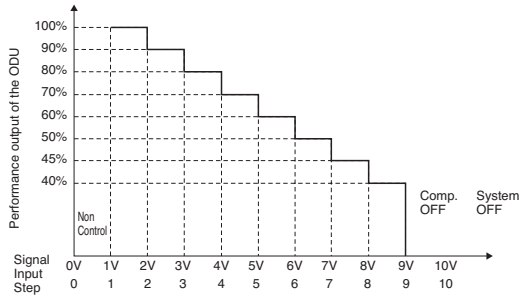

2.2 Night Low Noise control

ODU Dry contact has provided Two methods for Night Low Noise Control

- Automatically operating
 - : Using previous method
- Manual operating
 - : Using simple switch and timer

[Setting]

- For ODU Dry contact

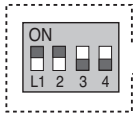

Notes

Default State is L1: ON, L2: ON

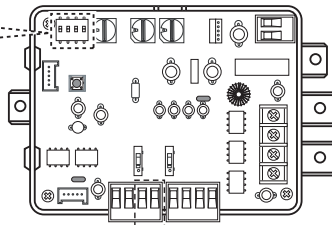

Connect with S/W or Timer for Night Low Noise Control

Position	Function
	ON : Master Mode OFF : Slave Mode
	ON : Enable Low Noise Operation OFF : Disable Low Noise Operation

- For Outdoor unit
 - Refer to DIP S/W setting table

2.3 Error Alarm monitoring

ODU Dry contact has provided Error Alarm monitoring function

Notice for system fault information by buzzer or warning lamp.
 Occurring fault is not only ODUs but also IDUs.

[Setting]

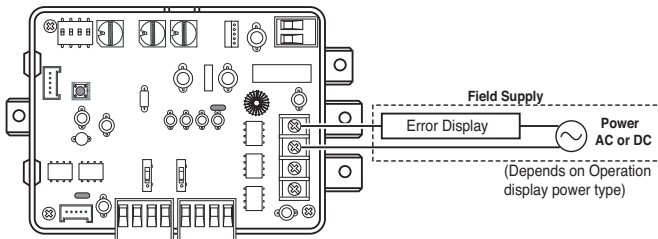

- Note
 - AC Power : 3A @250V
 - DC Power : 3A @30V

Caution For Refrigerant Leak

The installer and system specialist shall secure safety against leakage according to local regulations or standards. The following standards may be applicable if local regulations are not available.

Introduction

Though the R410A refrigerant is harmless and incombustible itself, the room to equip the air conditioner should be large to such an extent that the refrigerant gas will not exceed the limiting concentration even if the refrigerant gas leaks in the room.

Limiting concentration

Limiting concentration is the limit of Freon gas concentration where immediate measures can be taken without hurting human body when refrigerant leaks in the air. The limiting concentration shall be described in the unit of kg/m^3 (Freon gas weight per unit air volume) for facilitating calculation.

Limiting concentration: $0.44\text{kg/m}^3(\text{R410A})$

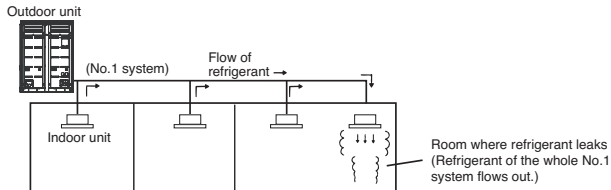

Checking procedure of limiting concentration

Check limiting concentration along following steps and take appropriate measure depending on the situation.

Calculate amount of all the replenished refrigerant (kg) per each refrigerant system.

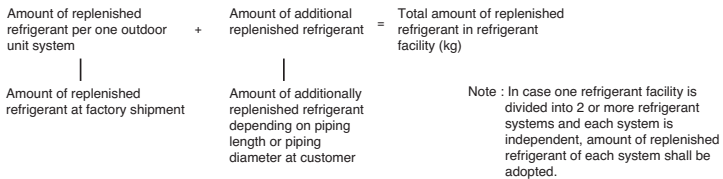

Calculate minimum room capacity

Calculate room capacity by regarding a portion as one room or the smaller room.

(1) Without partition

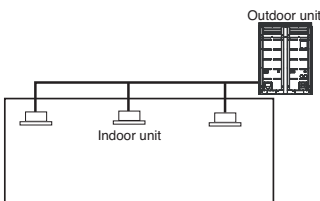

(2) With partition and with opening which serve as passage of air to adjoining room

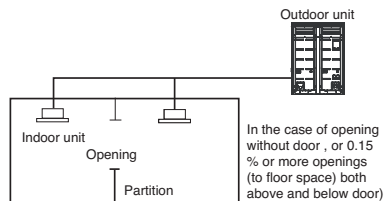

(3) With partition and without opening which serve as passage of air to adjoining room

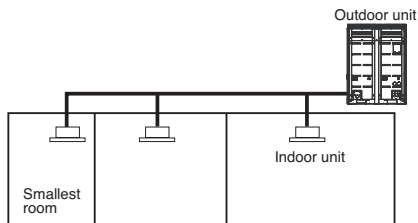

■ Calculate refrigerant concentration

$$\frac{\text{Total amount of replenished refrigerant in refrigerant facility (kg)}}{\text{Capacity of smallest room where indoor unit is installed (m}^3\text{)}} \leq \text{Refrigerant concentration (kg/m}^3\text{)} \quad \text{(R410A)}$$

In case the result of calculation exceeds the limiting concentration, perform the same calculations by shifting to the second smallest, and the third smallest rooms until at last the result is below the limiting concentration.

■ In case the concentration exceeds the limit

When the concentration exceeds the limit, change original plan or take one of the countermeasures shown below:

- **Countermeasure 1**
Provide opening for ventilation.
Provide 0.15% or more opening to floor space both above and below door, or provide opening without door.
- **Countermeasure 2**
Provide gas leak alarm linked with mechanical ventilator.
Reducing the outdoor refrigerant qty.

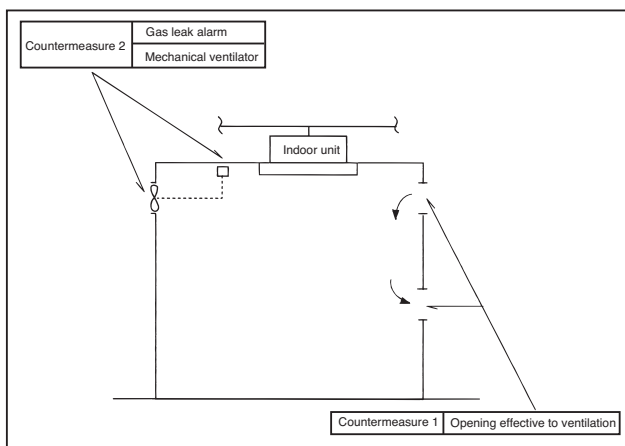

Pay a special attention to the place, such as a basement, etc. where refrigerant can stay, since refrigerant is heavier than air.

Installation guide at the seaside

CAUTION

1. Air conditioners should not be installed in areas where corrosive gases, such as acid or alkaline gas, are produced.
2. Do not install the product where it could be exposed to sea wind (salty wind) directly. It can result corrosion on the product. Corrosion, particularly on the condenser and evaporator fins, could cause product malfunction or inefficient performance.
3. If outdoor unit is installed close to the seaside, it should avoid direct exposure to the sea wind. Otherwise it needs additional anticorrosion treatment on the heat exchanger.

Selecting the location(Outdoor Unit)

- 1) If the outdoor unit is to be installed close to the seaside, direct exposure to the sea wind should be avoided. Install the outdoor unit on the opposite side of the sea wind direction.

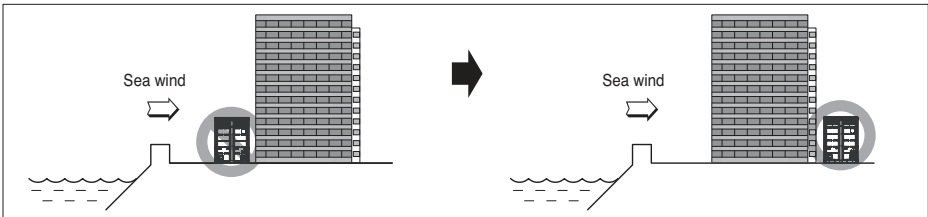

- 2) In case, to install the outdoor unit on the seaside, set up a windbreak not to be exposed to the sea wind.

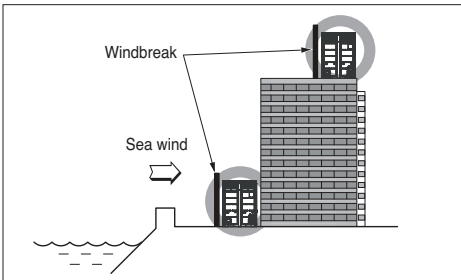

- It should be strong enough like concrete to prevent the sea wind from the sea.
- The height and width should be more than 150% of the outdoor unit.
- It should be kept more than 70 cm of space between outdoor unit and the windbreak for easy air flow.

- 3) Select a well-drained place.

1. Periodic (more than once/year) cleaning of the dust or salt particles stuck on the heat exchanger by using water.