



OWNER'S MANUAL

Portable Bluetooth Speaker

Please read this manual carefully before operating your set and retain it for future reference.

MODELS

PK3

PK3L

www.lg.com

Copyright © 2018 LG Electronics Inc. All Rights Reserved.

Safety Information



CAUTION: TO REDUCE THE RISK OF ELECTRIC SHOCK DO NOT REMOVE COVER (OR BACK) NO USER-SERVICEABLE PARTS INSIDE REFER SERVICING TO QUALIFIED SERVICE PERSONNEL



This lightning flash with arrowhead symbol within an equilateral triangle is intended to alert the user to the presence of uninsulated dangerous voltage within the product's enclosure that may be of sufficient magnitude to constitute a risk of electric shock to persons.



The exclamation point within an equilateral triangle is intended to alert the user to the presence of important operating and maintenance (servicing) instructions in the literature accompanying the product.

WARNING: TO PREVENT FIRE OR ELECTRIC SHOCK HAZARD, DO NOT EXPOSE THIS PRODUCT TO RAIN OR MOISTURE.

CAUTION: The apparatus should not be exposed to water (dripping or splashing) and no objects filled with liquids, such as vases, should be placed on the apparatus.

WARNING: Do not install this equipment in a confined space such as a book case or similar unit.

CAUTION: Do not use high voltage products around this product. (ex. Electrical swatter) This product may malfunction due to electrical shock.

CAUTION: No naked flame sources, such as lighted candles, should be placed on the apparatus.

CAUTION: Do not block any ventilation openings. Install in accordance with the manufacturer's instructions.

Slots and openings in the cabinet are provided for ventilation and to ensure reliable operation of the product and to protect it from over heating. The openings shall be never be blocked by placing the product on a bed, sofa, rug or other similar surface. This product shall not be placed in a built-in installation such as a bookcase or rack unless proper ventilation is provided or the manufacturer's instruction has been adhered to.

CAUTION concerning the Power Cord

The Power Plug is the disconnecting device. In case of an emergency, the Power Plug must remain readily accessible.

Check the specification page of this owner's manual to be certain of the current requirements.

Do not overload wall outlets. Overloaded wall outlets, loose or damaged wall outlets, extension cords, frayed power cords, or damaged or cracked wire insulation are dangerous. Any of these conditions could result in electric shock or fire. Periodically examine the cord of your device, and if its appearance indicates damage or deterioration, unplug it, discontinue use of the device, and have the cord replaced with an exact replacement part by an authorized service center. Protect the power cord from physical or mechanical abuse, such as being twisted, kinked, pinched, closed in a door, or walked upon. Pay particular attention to plugs, wall outlets, and the point where the cord exits the device.

NOTICE: For safety marking information including product identification and supply ratings, please refer to the main label on the bottom or the other surface of the product.

CAUTION when using this product in environments of low humidity

- It may cause static electricity in environments of low humidity.
- It is recommended to use this product after touching any metal object which conducts electricity.

This device is equipped with a portable battery or accumulator.

How to Safely remove the batteries or the battery pack from the equipment: To Remove the old batteries or battery pack, follow the assembly steps in reverse order. To prevent contamination of the environment and bring on possible threat to human and/or animal health, the old batteries or the battery pack must be put in an appropriate container at designated collection points. Do not dispose of batteries or battery pack together with other waste. It is recommended that you use local, free reimbursement systems batteries or battery packs, (may not be available in your area). The batteries or the battery pack should not be exposed to excessive heat such as sunshine, fire or the like.

Symbols

~	Refers to alternating current (AC).
≡	Refers to direct current (DC).
⊞	Refers to class II equipment.
⏻	Refers to stand-by.
I	Refers to "ON" (power).
⚡	Refers to dangerous voltage.

Table of Contents

1 Getting Started

- 2 Safety Information
- 6 Unique features
- 6 Introduction
- 7 Front
- 8 Rear

2 Operating

- 9 Charging the speaker
 - 9 – Charging with the AC adapter
 - 9 – Checking the charging status
- 10 – Checking Battery status
- 11 Basic Operations
 - 11 – Using power button
 - 11 – Bluetooth Connection
 - 11 – Bluetooth LED status
 - 12 – Simple Operation Guide
- 13 Handsfree Function
- 14 Voice Command
- 15 Sound Effect
 - 15 – Setting Sound effect
- 16 Listening to Music from Your External Device
- 17 Using BLUETOOTH® technology
 - 17 – Listening to music stored on the BLUETOOTH devices
- 19 Multi phone pairing
- 21 Other Operation
 - 21 – Resetting
 - 21 – Notice for Auto Power Off

3 Troubleshooting

- 22 Troubleshooting

4 Appendix

- 23 Trademarks and Licenses
- 23 Handling the Unit
- 24 Specifications

1

2

3

4

Unique features

1

Getting Started

Auto power off

This unit supports to turn off by itself for saving energy consumption. (Page 21)

Portable In

Listen to music from your portable device. (Smart phone, Notebook, etc..)

BLUETOOTH®

Listens to music stored on your **Bluetooth** device.

Introduction

Symbol used in this manual

! Note

Indicates special notes and operating features.

! Caution

Indicates cautions for preventing possible damages from abuse.

! Caution

Water-proof (IPX7)

This speaker is water-proof according to IPX7. IPX7 is a Water-proof up to 1 meter (3.28 ft) for 30 minutes. Speaker is water-proof wireless speaker but it can be damaged. Avoid the cases below.

- Do not use the unit under water or other liquid.
- When you use the unit, close the port cover securely.
- When battery is charging, do not expose the unit to water.
- When exposed to water, wipe off it with a soft dry cloth. Thoroughly dry it before using the speaker.
- Ports are not water-proof. Make sure close the port cover securely. Refer to below image.

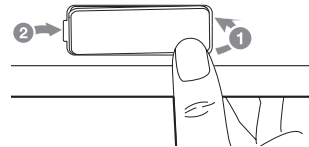

- Position port cover onto ① and securely press it in ②.

The water resistant performance of the system is based on our measurements under the conditions herein described. Note that malfunctions as a result of water immersion caused by misuse by the customer are not covered by the warranty.

Front

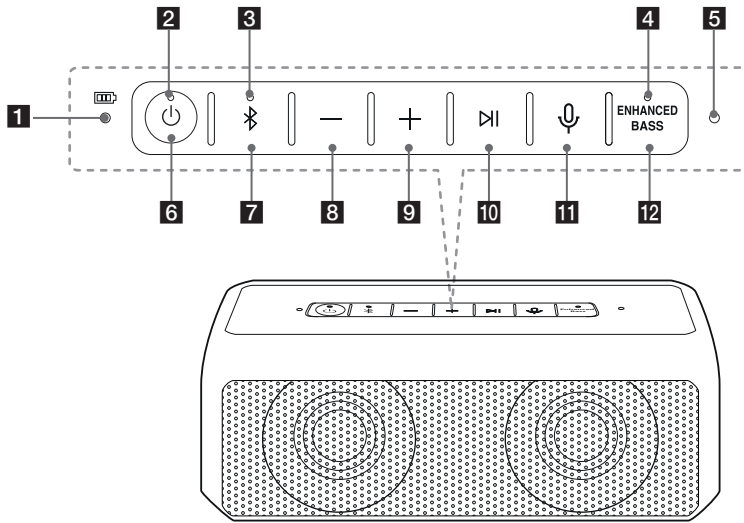

1 Battery LED

2 Power LED

3 Bluetooth LED

4 ENHANCED BASS LED

5 Microphone

6

Turns On / Off. Press it.

7

- Adds a **Bluetooth** device for multi phone pairing. (Press and hold for 2 seconds)
If you press the button, the previous connected **Bluetooth** device will be disconnected.
Please select "LG-PK3 (XX)" from the device list on the **Bluetooth** setting of the disconnected device for the multi-phone connection.
- Changes to **Bluetooth** mode in portable mode. (Press)

* When you connect the portable cable, the function is changed to portable mode.

8 —

Turn down the volume.

9 +

Turn up the volume.

10

- Plays, pauses or skip playback on the **Bluetooth** mode. (Page 12)

- Receives a call on the **Bluetooth** device. (Page 13)

- Mutes the sound on the portable mode.

11

Use Voice Command of your smart device. (Page 14)

12 ENHANCED BASS

Changes sound effect. (Page 15)

Rear

1

Getting Started

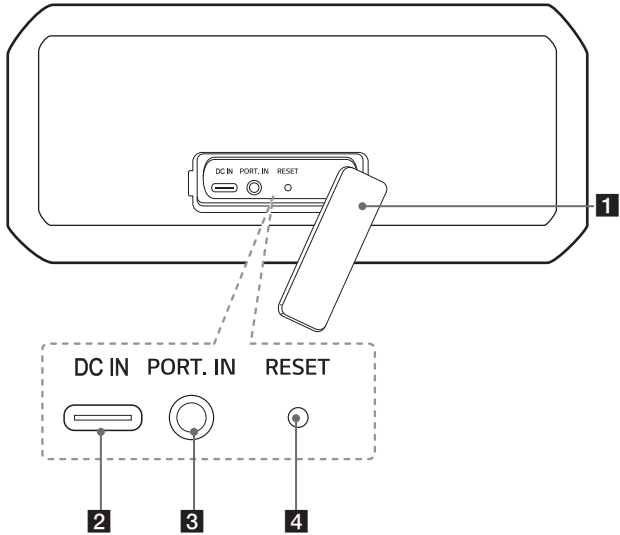

1 Port cover

2 USB port for charging

3 PORT.IN

Listens to music from your portable device.

4 RESET button

Charging the speaker

Charging with the AC adapter

This speaker uses built-in battery. Before using it, charge the battery by connecting the AC Adapter.

1. Connect the supplied USB cable to the AC adapter.
2. Connect the USB cable to USB port of the speaker.
3. Plug the AC power cord into an AC outlet.

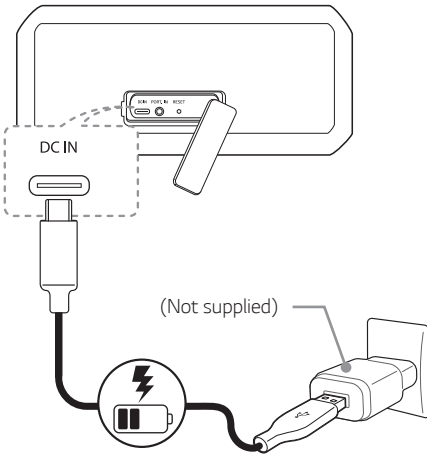

! Note



Operating time is approx. 12 hours. It is based on what fully charged the battery, continuous playback using 50 % volume level and turning off equalizer function. It may vary depending on the battery status and operational conditions.

! Caution

AC adapter is not supplied. It is recommended that you use the 5 V AC adapter approved by LG Electronics Inc. (more than 1.8 A) with this speaker because of danger of explosion. If you do not use the recommended adapter, charging is unavailable or charging time may differ.

Checking the charging status

When speaker's battery is charging, you can check the charging status by Battery LED.







LED	Description
 →  Green → Off	Battery is fully charged.
 Red	Battery is charging.

! Note

- If you listen to the music while charging, it will take longer to charge.
- When the speaker is not charging by overheating, Battery LED turn on red and amber alternately. And charging is stopped.
- When the speaker's battery is fully charged, the Battery LED turn on green for 15 seconds and then off.

Checking Battery status

If the power is turned on, you can check the charging status by pressing the  button for 2 seconds. Then Battery LED light will change depending on battery charging status.

LED	Description	Status
 Green	Battery LED turns on green.	 $\geq 70\%$
 Amber	Battery LED turns on amber.	 $> 10\%$
 Red	Battery LED continuously blinks in red with the sound.	 $\leq 10\%$

Note

- The Battery LED turns on for 3 seconds, after the  button press for 2 seconds.
- Checking Battery status is not checked when the speaker is charging.

Basic Operations

Using power button

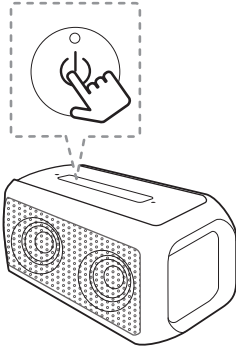

Power On / Off

Press the  button.

Bluetooth Connection

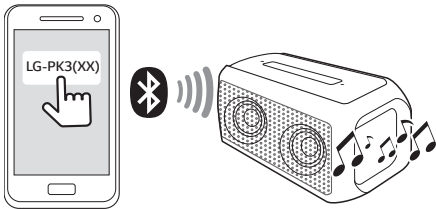



Play the desired music on the **Bluetooth** device. After pairing, you can control playback using the buttons on the unit. (Page 12, 17-18)

Bluetooth LED status

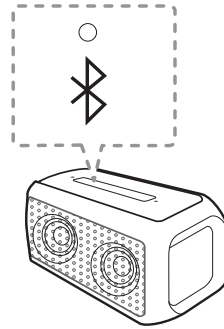
Check the **Bluetooth** LED blinks before connecting **Bluetooth** device.













LED	Status	Description
	Bluetooth LED blinks with the sound.	Searching for Bluetooth device.
	Bluetooth LED turns on with the sound.	Bluetooth device is connected.

Note

- In Portable mode, **Bluetooth** LED turns off.
- Once pairing is performed, it does not need to be done again even if you turn off this unit.

Simple Operation Guide

Function	How to	Status
Power On	Press the  button.	Power LED turns on with the sound.
Power Off	Press the  button.	Power LED turns off with the sound.
Bluetooth pairing	When Bluetooth LED blinks, select LG-PK3 (XX) from device list on your Bluetooth device.	Bluetooth LED turns on with the sound.
Multi phone pairing	Press and hold  for 2 seconds to add another Bluetooth device. <ul style="list-style-type: none"> When searching for another device, all connected Bluetooth devices will be disconnected. Please select "LG-PK3 (XX)" from the device list on the Bluetooth setting of the disconnected device for the multi-phone connection. 	During the search for another device, the Bluetooth LED blinks. After pairing, Bluetooth LED stays white with the sound.
Volume control	Press  or  .	When this unit reaches maximum volume, you can hear beep sound.
Play / Pause	Press  .	-
Forward skip	Press  twice.	-
Backward skip	Press  three times.	-
Handsfree	Press  .	Receive and disconnect a call.
Bluetooth Initialization	Press and hold  for 7 seconds.	Power and Bluetooth LED blinks 4 times. Then this unit is turned off automatically.

Note

- You can adjust playback or volume by using your **Bluetooth** device.
- After initializing **Bluetooth**, it needs to reconnect with **Bluetooth** device. (In case of iOS devices, try to reconnect with **Bluetooth** device after deleted existing connection on **Bluetooth** device.)

Handsfree Function

You can receive incoming call on your **Bluetooth** device to this unit. Connect the unit to a **Bluetooth** device.

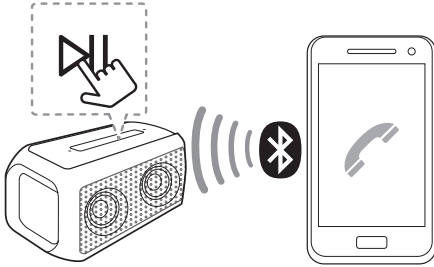

Function	How to
Receive a call.	Press ▶ .
End the call.	Press ▶ .
Reject a call.	Press and hold ▶ for 2 seconds
Toggle between speaker and your Bluetooth device during a call. (Speaker ↔ Bluetooth device)	Press and hold ▶ for 2 seconds

! Note

- Only smartphone is available to use this function.
- To adjust the call volume, press **-**, **+** buttons on the unit.
- On some **Bluetooth** devices, when an incoming call is received, it might ring the built-in ringtone, (ex. iOS devices) The Built-in ringtone is not adjustable.
- In multi phone pairing mode, you can only receive the call of one of the connected devices on the speaker.
- If a call is connected between multi paired **Bluetooth** device, hands free does not work correctly.
- Even if you switch to portable mode while in **Bluetooth** connection status, you can still use this function.
- To use this mode, some of **Bluetooth** device needs to be changed to speaker mode on call mode. (ex. iOS devices)
- If you receive a call by using talk button on your phone, it will be connected a call to your phone. (Only iOS devices)
- If you do not want to use this function, disable the **Bluetooth** setting on your phone. Connect **Bluetooth** again to use this mode.

Voice Command

You can speak to operate the voice command of your smartphone through speaker's microphone by using the voice command app or the Siri.

! Note

Make sure you use the smart device that has voice command.

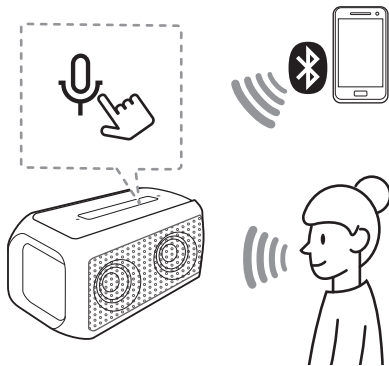

1. Connect the speaker to smart device through **Bluetooth**.
2. Press the Ψ button to active voice command of your smart device.
3. Activate Voice Command app as follow.
 - Android O/S: Select the voice command app.
 - iOS O/S: Siri activates automatically.
4. Make a request to voice command app or Siri through microphone of speaker.

! Note

- When Voice Command time limit exceeded on smart devices, this function automatically cancel.
- It is recommended that you use the Google app (Google Assistant, Google Now etc.) when enjoying this function by using Android device. Google app is provided by Google. Some of location may not support by Google Policy.
- If you want to cancel Voice command mode, press the Ψ button again when this function is activating.
- For more information, refer to voice command app or Siri.
- Speaking at near microphone will increase the success rate.
- It may not work depending on the **Bluetooth** device.

Sound Effect

Sound Effect is optimally tuned in UK's high-end audio company MERIDIAN. MERIDIAN technology provides wide sound field and rich bass.

You can select a desired sound effect you want, Enhanced Bass or Standard by using **ENHANCED BASS** button.

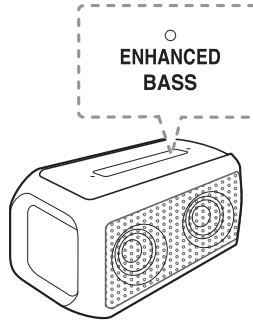

Setting Sound effect

○ On / ● Off

LED	Function	Description
○ Enhanced Bass	Enhanced Bass	You can enjoy Wide sound field and rich bass with emphasis the bass and warmth of the music. - Enhanced Bass is more effective for music with bass.
● Enhanced Bass	Standard	You can enjoy pure and natural sound.

! Note

- When you turn the speaker back on, the last used option will be on.
- When you select "Standard" or "Enhanced Bass" sound effect, you can enjoy premium sound with MERIDIAN technology.
- Because fine-tune sound to provide optimal high-quality sound, It might be a little difference between sound effect modes.

Listening to Music from Your External Device

The unit can be used to listen to the music from many types of external device.

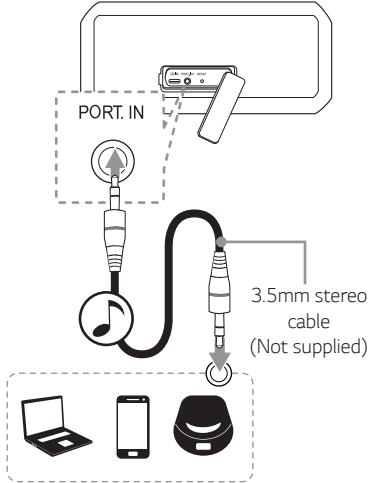

1. Connect the external device to the **PORT.IN** (3.5mm) connector of the unit.
2. Turn the power on by pressing **⏻** button.
3. Turn the external device on and start playing.

! Note

- When you connect the portable cable, the function is changed to portable mode automatically.
- In Portable mode, speaker limits **Bluetooth** connection to prevent unintended **Bluetooth** connection.
- When the **⌘** button is pressed during this mode, it will switch to **Bluetooth** mode.

Using BLUETOOTH® technology

About BLUETOOTH

Bluetooth is wireless communication technology for short range connection.

The sound may be interrupted when the connection interfered by the other electronic wave or you connect the **Bluetooth** in the other rooms.

Connecting individual devices under **Bluetooth** wireless technology does not incur any charges. A mobile phone with **Bluetooth** wireless technology can be operated via the Cascade if the connection was made via **Bluetooth** wireless technology.

- Available Devices: Smart phone, Notebook, etc.
- Version: 4.2
- Codec: SBC, AAC, AptX

BLUETOOTH Profiles

In order to use **Bluetooth** wireless technology, devices must be able to interpret certain profiles. This unit is compatible with following profile.

A2DP (Advanced Audio Distribution Profile)
HFP (Handsfree Profile)

Listening to music stored on the BLUETOOTH devices

Pairing your unit and BLUETOOTH device

Before you start the pairing procedure, make sure the **Bluetooth** feature is turned on in your **Bluetooth** device. Refer to your **Bluetooth** device's user guide. Once a pairing operation is performed, it does not need to be performed again.

1. Turn on the unit then **Bluetooth** LED blinks with the sound.

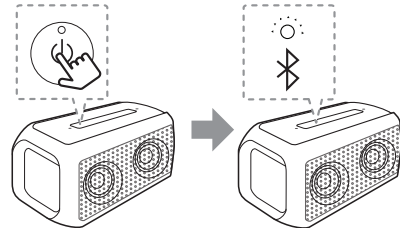

2. Operate the **Bluetooth** device and perform the pairing operation. When searching for this unit with the **Bluetooth** device, a list of the devices found may appear in the **Bluetooth** device display depending on the type of **Bluetooth** device. Your unit appears as "LG-PK3 (xx)".

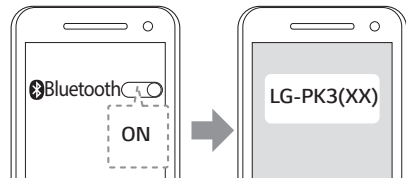

3. Select "LG-PK3 (xx)":

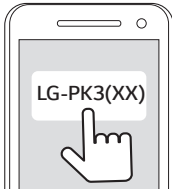

Note

- XX means the last two digits of **Bluetooth** address. For example, if your unit has a **Bluetooth** address such as 9C:02:98:4A:F7:08, you will see "LG-PK3 (08)" on your **Bluetooth** device.
- Depending on the **Bluetooth** device type, some device have a different pairing way. Enter the PIN code (0000) as needed.

4. When this unit is successfully connected with your **Bluetooth** device, **Bluetooth** LED will turn on with the sound.

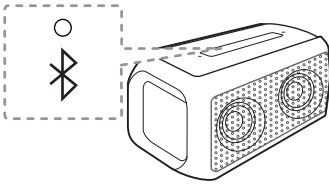

5. Listen to music.
To play a music stored on your **Bluetooth** device, refer to your **Bluetooth** device's user guide.

Note

- When using **Bluetooth** technology, you have to make a connection between the unit and the **Bluetooth** device as close as possible and keep the distance close. However you may experience issues in the cases below:
 - There is an obstacle between the unit and the **Bluetooth** device.
 - There is a device using same frequency with **Bluetooth** technology such as a medical equipment, a microwave or a wireless LAN device.
- If **Bluetooth** connection does not work well, go to step 1 of "Pairing your unit and **BLUETOOTH** device" and try again.
- The sound may be interrupted when the connection interfered by the other electronic waves.
- Depending on the type of the device, you may not be able to use the **Bluetooth** function.
- You can enjoy **Bluetooth** function using Smart phone, Notebook, etc..
- The more distance between the unit and the **Bluetooth** device, the lower the sound quality becomes.
- **Bluetooth** connection will be disconnected when the unit is turned off or the **Bluetooth** device gets too far from the unit.
- When **Bluetooth** connection is disconnected, connect the **Bluetooth** device to the unit again.
- **Bluetooth** connection will be maintained even if you change the **Bluetooth** function to a different function.
- When you connect a **Bluetooth** device (iOS device etc.) to this unit or operate the device, the volume level will be synchronized between each device.
- When the unit is not connected, **Bluetooth** LED will blink.
- When you use the **Bluetooth** function, adjust the volume to a proper level on the **Bluetooth** device.

Multi phone pairing

The unit can be connected to 2 **Bluetooth** devices at the same time.

Pairing with Two Devices

1. Connect the unit to a **Bluetooth** device.
(Page 17-18)
2. To connect another **Bluetooth** device, press and hold **⌘** button for 2 seconds

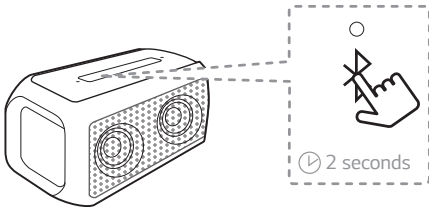

- Then **Bluetooth** LED blinks with the sound. The unit is changed to phone pairing mode.
- And previous connected devices will be disconnected with sound.

! Note

Step 2 is necessary only for the first connection. You do not have to do it from next connection.

3. Select "LG-PK3 (XX)" from device list on another **Bluetooth** device.



- Then the speaker is connection with another Bluetooth device.
- And **Bluetooth** LED turned on of unit.

4. Select "LG-PK3 (XX)" from device list on previous **Bluetooth** device.

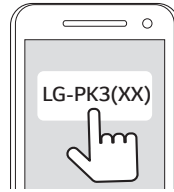

- Then the speaker is connection with 2 Bluetooth devices.

5. When connection of 2 **Bluetooth** devices are successful, you can check it on each **Bluetooth** device.



! Note

- You can connect this unit with up to 2 **Bluetooth** devices simultaneously by using the same method as described on the previous page. (Page 19)
- The multi phone pairing connection is only supported on Android devices. (Multi phone pairing connection may not be supported depending on the connected device's specifications.)
- Even if this speaker is connected with up to 2 **Bluetooth** devices, you cannot play and control music on both **Bluetooth** devices at same time. Stop the music if you want to play the other **Bluetooth**.
- Removable/detachable **Bluetooth** device (Ex: Dongle etc..) doesn't support multi phone pairing.
- After multi-pairing connection, it takes a little time for the music to be played depending on the **Bluetooth** devices.
- In case of multi phone pairing, automatically connection of 2 **Bluetooth** devices is not supported. Only one **Bluetooth** device will be automatically connected to the speaker. The other device should be connected manually.
- If you get out of **Bluetooth**'s effective distance without disconnecting **Bluetooth**, it may take a few minutes to connect other **Bluetooth** devices. But after power off and on, you can connect other **Bluetooth** devices without waiting.
- If you try to pair a new **Bluetooth** device when it is connected with 2 **Bluetooth** devices, this speaker automatically disconnects all **Bluetooth** devices.
- In case of multi-pairing, voice command is not supported.

Other Operation

Resetting

In case that the unit freezes due to malfunction, press the RESET button using an object like a thin pin. Then speaker turns off. Press  button to try turning on speaker again.

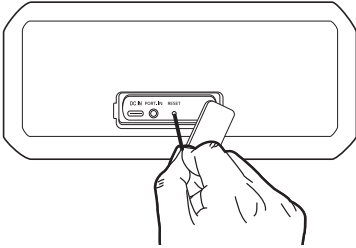

Note

Reset function does not work during charging.

Notice for Auto Power Off

If you do not play music and do not press button for 15 minutes in **Bluetooth** mode, this unit is turned off automatically. Or if there is no button operation for 6 hours in portable input mode, this unit is turned off automatically.

Troubleshooting

Problem	Cause & Correction
No Power.	<ul style="list-style-type: none"> • The battery is discharged. Recharge the battery. • Connect the unit to the power supply with the AC adapter.
No sound or sound distortion.	<ul style="list-style-type: none"> • The unit or your smart device's volume is set to minimum. Check and adjust the volume of the unit or Bluetooth device's volume. • When you use an external device at high volume, the sound quality may be deteriorated. Lower the volume of the devices. • If you use the unit for purposes other than listening to music, the sound quality may be lowered or the unit may not work properly.
Bluetooth pairing does not work well.	<ul style="list-style-type: none"> • Switch Bluetooth off and on again on your Bluetooth device, then try pairing again. • Be sure your Bluetooth device is on. • Remove the obstacle in the path of the Bluetooth device and the unit. • Depending on the type of the Bluetooth device or surrounding environment, your device may not be paired with the unit.
The unit does not operate normally.	<ul style="list-style-type: none"> • If the battery was fully discharged, the stored Bluetooth information can be deleted. Previous setting may not be saved when the unit's power is shut off. • In case of malfunction, please use the unit in proper place where the temperature or humidity is not so high or low. • In case of overload, power and Bluetooth LEDs blink white. Please turn the power off and then on again.
Above solutions do not work.	<ul style="list-style-type: none"> • Press the RESET button on speaker using an object like a thin pin. (Page 21)

Trademarks and Licenses



The **Bluetooth**® word mark and logos are registered trademarks owned by the Bluetooth SIG, Inc. and any use of such marks by LG Electronics is under license. Other trademarks and trade names are those of their respective owners.

Handling the Unit

When shipping the unit

Please save the original shipping carton and packing materials. If you need to ship the unit, for maximum protection, re-pack the unit as it was originally packed at the factory.

Keeping the exterior surfaces clean

- Do not use volatile liquids such as insecticide spray near the unit.
- Wiping with strong pressure may damage the surface.
- Do not leave rubber or plastic products in contact with the unit for a long period of time.

Cleaning the unit

To clean the player, use a soft, dry cloth. If the surfaces are extremely dirty, use a soft cloth lightly moistened with a mild detergent solution. Do not use strong solvents such as alcohol, benzene, or thinner, as these might damage the surface of the unit.

Specifications

General	
Power requirements	5 V  1.8 A (AC adapter) Built-in rechargeable battery
Power consumption	Refer to the main label.
Dimensions (W x H x D)	Approx. 182 mm X 82 mm X 82 mm (7.17 inch x 3.23 inch x 3.23 inch)
Operating temperature	5 °C to 35 °C (41 °F to 95 °F)
Operating humidity	5 % to 60 %
Water-proof	IPX7

Inputs	
PORT. IN	0.5 Vrms (3.5 mm stereo jack)

Battery	
Battery capacity	3.7 Vdc, 5200mAh (Typ) 3.7 Vdc, 5200 mAh (Min)
Operating time	Approx. 12 hours. It may vary depending on the battery status and operational conditions.
Charging time	Less than 4 hours (with AC Adapter). It can be varied depending on the conditions of the battery or operation.

- Design and specifications are subject to change without notice.

