

1

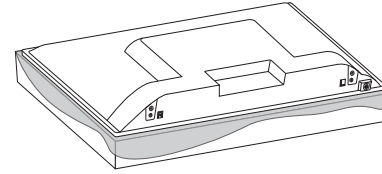

2

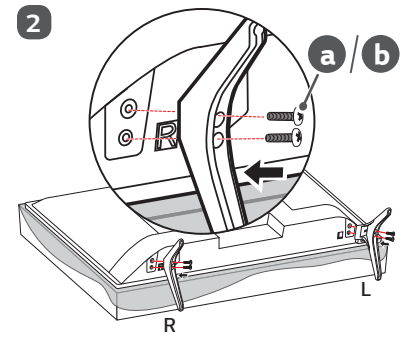

3

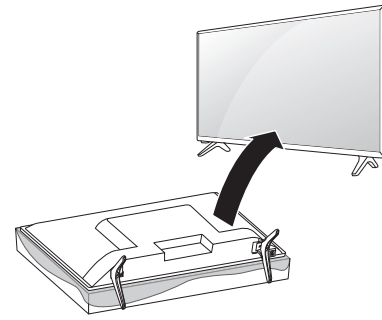

4

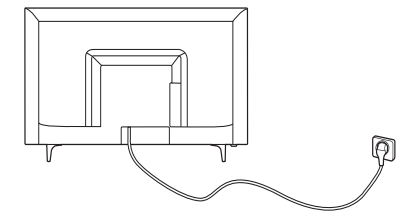

English

- Read **Safety and Reference**.
- For the power supply and power consumption, refer to the label attached to the product.

• قراءة الأمان والمرجع.

• لمعرفة المزيد حول مصدر الإمداد بالطاقة المطلوب ومعايير استهلاك الطاقة، راجع الملصق الموجود على المنتج.

العربية

Français

- Lire le document **Sécurité et référence**.
- Reportez-vous à l'étiquette apposée sur le téléviseur pour connaître l'alimentation et la consommation électrique.

Português

- Consulte o manual **Segurança e referência**.
- No que respeita à fonte de alimentação e ao consumo de energia, consulte a etiqueta mostrada no produto.

• יש לקרוא את האותובטיחות, הפניות ואיזכורים.

• לקבלת מידע לגבי אספקת המתח וצריכת החשמל, עיין בתווית שעל גבי המכשיר.

עברית

ภาษาไทย

- โปรดอ่านคู่มือผู้ใช้**ความปลอดภัยและการอ้างอิง**
- โปรดอ้างอิงแรงดันและความถี่ไฟฟ้าของเครื่องรับโทรทัศน์ได้จากฉลากด้านหลังเครื่อง

Tiếng Việt

- Đọc phần **An toàn và Tham khảo**.
- Để biết thông tin về nguồn điện và mức tiêu thụ điện, hãy tham khảo nhãn dán trên sản phẩm.



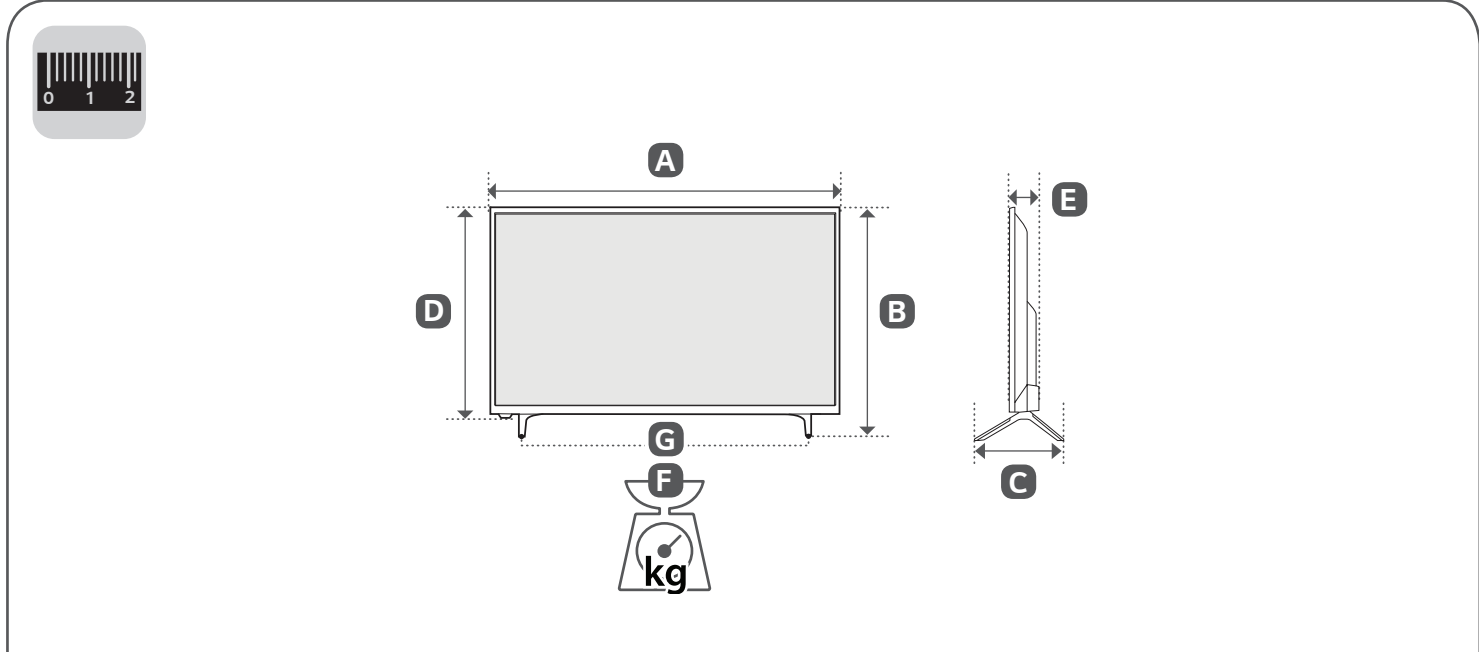
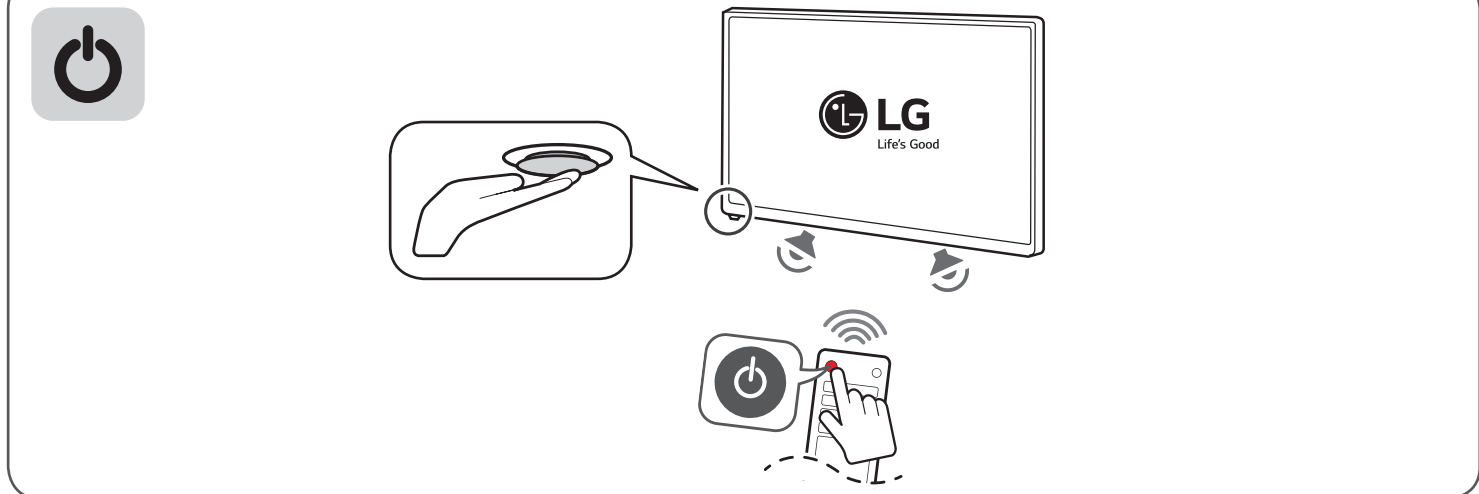
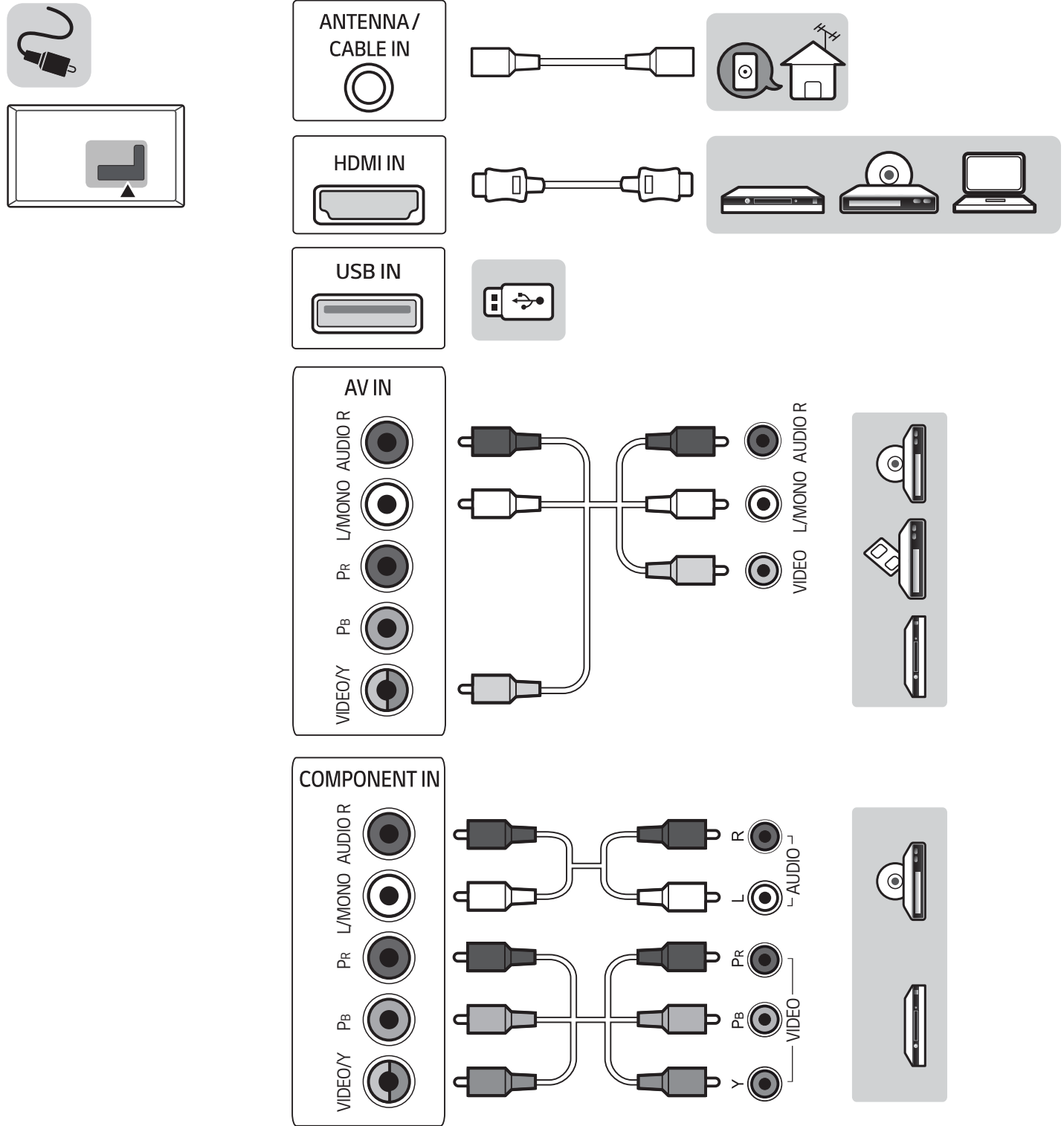

	A	B	C	D	E	F	F-G
	(mm / มม.)					(kg / กก.)	
32LK500BPTA 32LK500BYTA	729	474	182.8	436	75.8	3.9	3.8
43LK5000PTA 43LK5000YTA	968	625	217.8	569	82.3	7.1	6.9
28TK430V-PT	634	425	183	385	76	3.3	3.2
Power requirement / متطلبات الطاقة / Alimentation / Requisito de alimentação / דרושות חשמל / แรงดันและความถี่ไฟฟ้า / Nguồn điện yêu cầu	AC 100-240 V - 50 / 60 Hz						



OWNER'S MANUAL

Safety and Reference

LED TV*

* LG LED TV applies LCD screen with LED backlights.

Please read this manual carefully before operating your set and retain it for future reference.



* M F L 7 0 3 4 4 7 0 4 *

(1712-REV00)

www.lg.com

Copyright © 2018 LG Electronics Inc. All Rights Reserved.

Warning! Safety instructions



CAUTION : TO REDUCE THE RISK OF ELECTRIC SHOCK, DO NOT REMOVE COVER (OR BACK). NO USER-SERVICEABLE PARTS INSIDE. REFER TO QUALIFIED SERVICE PERSONNEL.



This symbol is intended to alert the user to the presence of uninsulated "dangerous voltage" within the product's enclosure that may be of sufficient magnitude to constitute a risk of electric shock to persons.



This symbol is intended to alert the user to the presence of important operating and maintenance (servicing) instructions in the literature accompanying the appliance.

WARNING : TO REDUCE THE RISK OF FIRE AND ELECTRIC SHOCK, DO NOT EXPOSE THIS PRODUCT TO RAIN OR MOISTURE.

- TO PREVENT THE SPREAD OF FIRE, KEEP CANDLES OR OTHER ITEMS WITH OPEN FLAMES AWAY FROM THIS PRODUCT AT ALL TIMES.
 - **Do not place the TV and/or remote control in the following environments:**
 - Keep the product away from direct sunlight.
 - An area with high humidity such as a bathroom
 - Near any heat source such as stoves and other devices that produce heat.
 - Near kitchen counters or humidifiers where they can easily be exposed to steam or oil.
 - An area exposed to rain or wind.
 - Do not expose to dripping or splashing and do not place objects filled with liquids, such as vases, cups, etc. on or over the apparatus (e.g., on shelves above the unit).
 - Near flammable objects such as gasoline or candles, or expose the TV to direct air conditioning.
 - Do not install in excessively dusty places.
- Otherwise, this may result in fire, electric shock, combustion/explosion, malfunction or product deformation.

• Ventilation

- Install your TV where there is proper ventilation. Do not install in a confined space such as a bookcase.
- Do not install the product on a carpet or cushion.
- Do not block or cover the product with cloth or other materials while unit is plugged in.
- Take care not to touch the ventilation openings. When watching the TV for a long period, the ventilation openings may become hot.
- Protect the power cord from physical or mechanical abuse, such as being twisted, kinked, pinched, closed in a door, or walked upon. Pay particular attention to plugs, wall outlets, and the point where the cord exits the device.
- Do not move the TV whilst the Power cord is plugged in.
- Do not use a damaged or loosely fitting power cord.
- Be sure do grasp the plug when unplugging the power cord. Do not pull on the power cord to unplug the TV.
- Do not connect too many devices to the same AC power outlet as this could result in fire or electric shock.
- **Disconnecting the Device from the Main Power**
 - The power plug is the disconnecting device. In case of an emergency, the power plug must remain readily accessible.
 - Do not let your children climb or cling onto the TV. Otherwise, the TV may fall over, which may cause serious injury.
- **Outdoor Antenna Grounding** (Can differ by country):
 - If an outdoor antenna is installed, follow the precautions below. An outdoor antenna system should not be located in the vicinity of overhead power lines or other electric light or power circuits, or where it can come in contact with such power lines or circuits as death or serious injury can occur. Be sure the antenna system is grounded to provide some protection against voltage surges and built-up static charges. Section 810 of the National Electrical Code (NEC) in the U.S.A. provides information with respect to proper grounding of the mast and supporting structure, grounding of the lead-in wire to an antenna discharge unit, size of grounding conductors, location of antenna discharge unit, connection to grounding electrodes and requirements for the grounding electrode. Antenna grounding according to the National Electrical Code, ANSI/NFPA 70

- **Grounding** (Except for devices which are not grounded.)
 - TV with a three-prong grounded AC plug must be connected to a three-prong grounded AC outlet. Ensure that you connect the earth ground wire to prevent possible electric shock.
 - Never touch this apparatus or antenna during a lightning storm. You may be electrocuted.
 - Make sure the power cord is connected securely to the TV and wall socket if not secured damage to the Plug and socket may occur and in extreme cases a fire may break out.
 - Do not insert metallic or inflammable objects into the product. If a foreign object is dropped into the product, unplug the power cord and contact the customer service.
 - Do not touch the end of the power cord while it is plugged in. You may be electrocuted.
 - **If any of the following occur, unplug the product immediately and contact your local customer service.**
 - The product has been damaged.
 - If water or another substance enters the product (like an AC adapter, power cord, or TV).
 - If you smell smoke or other odors coming from the TV
 - When lightning storms or when unused for long periods of time. Even the TV is turned off by remote control or button, AC power source is connected to the unit if not unplugged in.
 - Do not use high voltage electrical equipment near the TV (e.g., a bug zapper). This may result in product malfunction.
 - Do not attempt to modify this product in any way without written authorization from LG Electronics. Accidental fire or electric shock can occur. Contact your local customer service for service or repair. Unauthorized modification could void the user's authority to operate this product.
 - Use only an authorized attachments / accessories approved by LG Electronics. Otherwise, this may result in fire, electric shock, malfunction, or product damage.
 - Never disassemble the AC adapter or power cord. This may result in fire or electric shock.
 - Handle the adapter carefully to avoid dropping or striking it. An impact could damage the adapter.
 - To reduce the risk of fire or electrical shock, do not touch the TV with wet hands. If the power cord prongs are wet or covered with dust, dry the power plug completely or wipe dust off.
- **Batteries**
 - Store the accessories (battery, etc.) in a safe location out of the reach of children.
 - Do not short circuit, disassemble, or allow the batteries to overheat. Do not dispose of batteries in a fire. Batteries should not be exposed to excessive heat.
 - **Moving**
 - When moving, make sure the product is turned off, unplugged, and all cables have been removed. It may take 2 or more people to carry larger TVs. Do not press or put stress on the front panel of the TV. Otherwise, this may result in product damage, fire hazard or injury.
 - Keep the packing anti-moisture material or vinyl packing out of the reach of children.
 - Do not allow an impact shock, any objects to fall into the product, and do not drop anything onto the screen.
 - Do not press strongly upon the panel with a hand or a sharp object such as a nail, pencil, or pen, or make a scratch on it. It may cause damage to screen.
 - **Cleaning**
 - When cleaning, unplug the power cord and wipe gently with a soft/dry cloth. Do not spray water or other liquids directly on the TV. Do not clean your TV with chemicals including glass cleaner, any type of air freshener, insecticide, lubricants, wax (car, industrial), abrasive, thinner, benzene, alcohol etc., which can damage the product and/or its panel. Otherwise, this may result in electric shock or product damage.

Preparing

- If the TV is turned on for the first time after it was shipped from the factory, initialization of the TV may take a few minutes.
- Image shown may differ from your TV.
- Your TV's OSD (On Screen Display) may differ slightly from that shown in this manual.
- The available menus and options may differ from the input source or product model that you are using.
- New features may be added to this TV in the future.
- The device must be easily accessed to a location outlet near the access. Some devices are not made by turning on / off button, turning off the device and unplugging the power cord.
- The items supplied with your product may vary depending on the model.
- Product specifications or contents of this manual may be changed without prior notice due to upgrade of product functions.
- For an optimal connection, HDMI cables and USB devices should have bezels less than 10 mm thick and 18 mm width. Use an extension cable that supports USB 2.0 if the USB cable or USB memory stick does not fit into your TV's USB port.

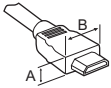

* $A \leq 10 \text{ mm}$

* $B \leq 18 \text{ mm}$

- Use a certified cable with the HDMI logo attached.
- If you do not use a certified HDMI cable, the screen may not display or a connection error may occur. (Recommended HDMI Cable Types)
 - High-Speed HDMI[®]/TM Cable (3 m or less)
 - High-Speed HDMI[®]/TM Cable with Ethernet (3 m or less)

Separate Purchase

Separate purchase items can be changed or modified for quality improvement without any notification. Contact your dealer to buy these items. These devices only work with certain models.

The model name or design may be changed depending on the upgrade of product functions, manufacturer's circumstances or policies. (Depending on model)

Wall Mounting Bracket

Make sure to use screws and wall mount bracket that meet the VESA standard. Standard dimensions for the wall mount kits are described in the following table.

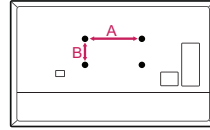

Model	32LK50*	43LK50*
VESA (A x B) (mm)	100 x 100	200 x 200
Standard screw	M4	M6
Number of screws	4	4
Wall mount bracket	LSW140B	LSW240B MSW240
Model	28TK43**	
VESA (A x B) (mm)	100 x 100	
Standard screw	M4	
Number of screws	4	
Wall mount bracket	RW120	

Lifting and moving the TV

Please note the following advice to prevent the TV from being scratched or damaged and for safe transportation regardless of its type and size.

- It is recommended to move the TV in the box or packing material that the TV originally came in.
- Before moving or lifting the TV, disconnect the power cord and all cables.
- When holding the TV, the screen should face away from you to avoid damage.



- Hold the side and bottom of the TV frame firmly. Make sure not to hold the transparent part, speaker, or speaker grill area.

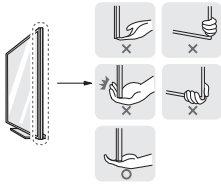

- When transporting a large TV, there should be at least 2 people.
- When transporting the TV by hand, hold the TV as shown in the following illustration.



- When transporting the TV, do not expose the TV to jolts or excessive vibration.
- When transporting the TV, keep the TV upright, never turn the TV on its side or tilt towards the left or right.
- Do not apply excessive pressure to cause flexing / bending of frame chassis as it may damage screen.
- When handling the TV, be careful not to damage the protruding buttons.



- Avoid touching the screen at all times, as this may result in damage to the screen.
- Do not move the TV by holding the cable holders, as the cable holders may break, and injuries and damage to the TV may occur.
- When attaching the stand to the TV set, place the screen facing down on a cushioned table or flat surface to protect the screen from scratches.

Mounting on the Table

- 1 Lift and tilt the TV into its upright position on a table.
 - Leave a 10 cm (minimum) space from the wall for proper ventilation.

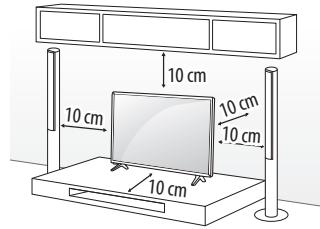

(Depending on model)

- 2 Connect the power cord to a wall outlet.



- Do not apply foreign substances (oils, lubricants, etc.) to the screw parts when assembling the product. (Doing so may damage the product.)
- If you install the TV on a stand, you need to take actions to prevent the product from overturning. Otherwise, the product may fall over, which may cause injury.
- Do not use any unapproved items to ensure the safety and product life span.
- Any damage or injuries caused by using unapproved items are not covered by the manufacturer's warranty.
- Make sure that the screws are inserted correctly and fastened securely. (If they are not fastened securely enough, the TV may tilt forward after being installed.) Do not use too much force and over tighten the screws; otherwise screw may be damaged and not tighten correctly.
- If a television is not positioned in a sufficiently stable location, it can be potentially hazardous due to falling. Many injuries, particularly to children, can be avoided by taking simple precautions such as:
 - Using cabinets or stands recommended by the manufacturer of the television.
 - Only using furniture that can safely support the television.
 - Ensuring the television is not overhanging the edge of the supporting furniture.
 - Not placing the television on tall furniture (for example, cupboards or bookcases) without anchoring both the furniture and the television to a suitable support.
 - Not standing the televisions on cloth or other materials placed between the television and supporting furniture.
 - Educating children about the dangers of climbing on furniture to reach the television or its controls.

Securing TV to the Wall

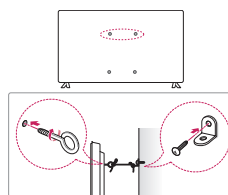

(Depending on model)

- 1 Insert and tighten the eye-bolts, or TV brackets and bolts on the back of the TV.
 - If there are bolts inserted at the eye-bolts position, remove the bolts first.
- 2 Mount the wall brackets with the bolts to the wall. Match the location of the wall bracket and the eye-bolts on the rear of the TV.
- 3 Connect the eye-bolts and wall brackets tightly with a sturdy rope. Make sure to keep the rope horizontal with the flat surface.
 - Use a platform or cabinet that is strong and large enough to support the TV securely.
 - Brackets, bolts and ropes are not provided. You can obtain additional accessories from your local dealer.

Mounting to the Wall

Attach an optional wall mount bracket at the rear of the TV carefully and install the wall mount bracket on a solid wall perpendicular to the floor. When you attach the TV to other building materials, please contact qualified personnel. LG recommends that wall mounting be performed by a qualified professional installer. We recommend the use of LG's wall mount bracket. LG's wall mount bracket is easy to move with cables connected. When you do not use LG's wall mount bracket, please use a wall mount bracket where the device is adequately secured to the wall with enough space to allow connectivity to external devices. It is advised to connect all the cables before installing fixed wall mounts.

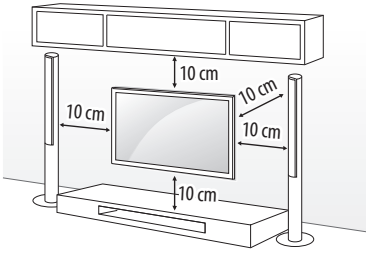

(Depending on model)



- Remove the stand before installing the TV on a wall mount by performing the stand attachment in reverse.
- For more information of screws and wall mount bracket, refer to the Separate Purchase.
- If you intend to mount the product to a wall, attach VESA standard mounting interface (optional parts) to the back of the product. When you install the set to use the wall mounting bracket (optional parts), fix it carefully so as not to drop.
- When mounting a TV on the wall, make sure not to install the TV by hanging the power and signal cables on the back of the TV.
- Do not install this product on a wall if it could be exposed to oil or oil mist. This may damage the product and cause it to fall.
- Screw length from outer surface of back cover should be under 8 mm. (Only 28TK43**, 32LK50*)

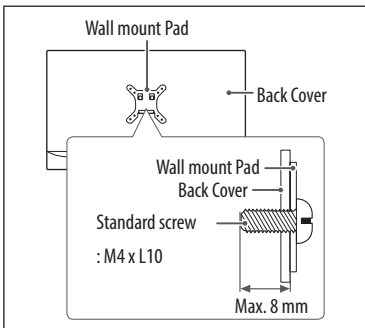

Connections

Connect various external devices to the TV and switch input modes to select an external device. For more information of external device's connection, refer to the manual provided with each device.

Antenna/Cable

Connect the TV to a wall antenna socket with an RF cable (75 Ω).

- Use a signal splitter to use more than 2 TVs.
- If the image quality is poor, install a signal amplifier properly to improve the image quality.
- If the image quality is poor with an antenna connected, try to realign the antenna in the correct direction.
- An antenna cable and converter are not supplied.

Other connections

Connect your TV to external devices. For the best picture and audio quality, connect the external device and the TV with the HDMI cable. Some separate cable is not provided.

HDMI

- Supported HDMI Audio format (Depending on model) :
AC3 (32 KHz/44.1 KHz/48 KHz),
PCM (32 KHz/44.1 KHz/48 KHz/96 KHz)

External Devices

Available external devices are: Blu-ray player, HD receivers, DVD players, VCRs, audio systems, USB storage devices, PC, gaming devices, and other external devices.

- The external device connection may differ from the model.
- Connect external devices to the TV regardless of the order of the TV port.
- If you record a TV program on a Blu-ray/DVD recorder or VCR, make sure to connect the TV signal input cable to the TV through a DVD recorder or VCR. For more information of recording, refer to the manual provided with the connected device.
- Refer to the external equipment's manual for operating instructions.
- If you connect a gaming device to the TV, use the cable supplied with the gaming device.
- In PC mode, there may be noise associated with the resolution, vertical pattern, contrast or brightness. If noise is present, change the PC output to another resolution, change the refresh rate to another rate or adjust the brightness and contrast on the PICTURE menu until the picture is clear.
- In PC mode, some resolution settings may not work properly depending on the graphics card.



- Do not drop the product or let it fall over when connecting external devices. Otherwise, this may result in injury or damage to the product.
- When connecting external devices such as video game consoles, make sure the connecting cables are long enough. Otherwise, the product may fall over, which may cause injury or damage the product.

Using Button

You can simply operate the TV functions, using the button. (Depending on model)

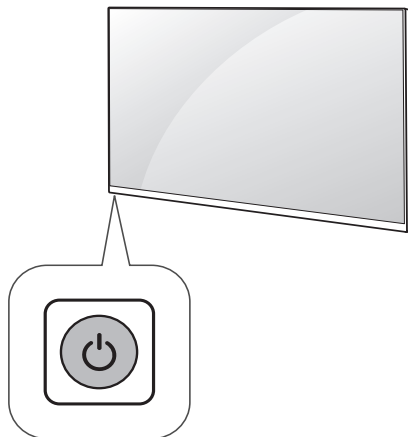

Basic functions

	Power On / Off (Press)
--	------------------------

Using Remote Control

The descriptions in this manual are based on the buttons on the remote control. Please read this manual carefully and use the TV correctly.

To replace batteries, open the battery cover, replace batteries (1.5 V AAA) matching the ⊕ and ⊖ ends to the label inside the compartment, and close the battery cover. To remove the batteries, perform the installation actions in reverse.



- In Analogue TV and some countries, some remote control buttons may not work.

Make sure to point the remote control toward the remote control sensor on the TV.

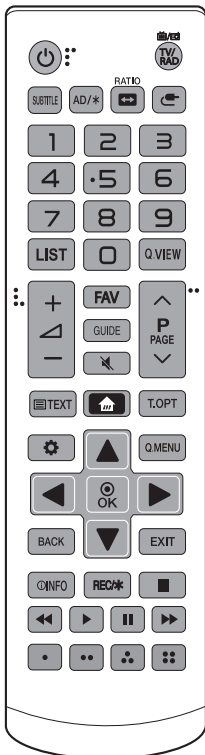

(Some buttons and services may not be provided depending on models or regions.)

⏻ (POWER) Turns the TV on or off.

TV/RAD Selects Radio, TV and DTV programme.

SUBTITLE Recalls your preferred subtitle in digital mode.

AD/* Audio descriptions function will be enabled. (Depending on model)

📺 RATIO Resizes an image.

📶 (INPUT) Changes the input source.

Number buttons Enters numbers.

LIST Accesses the saved programme list.

Q.VIEW Returns to the previously viewed programme.

+/- Adjusts the volume level.

FAV Accesses your favourite programme list.

GUIDE Shows programme guide.

🔇 (MUTE) Mutes all sounds.

^ P v Scrolls through the saved programmes.

^ PAGE v Moves to the previous or next screen.

Teletext buttons (, ,) These buttons are used for teletext.

🏠 (HOME) Accesses the Home menu.

⚙️ (Settings) Accesses the Settings menu.

Q.MENU Accesses the Quick menus.

Navigation buttons (up/down/left/right) Scrolls through menus or options.

⊙ OK Selects menus or options and confirms your input.

BACK Returns to the previous level.

EXIT Clears on-screen displays and returns to TV viewing.

ⓘ INFO Views the information of the current programme and screen.

REC/* Starts to record and displays record menu. (Only Time Machine^{Ready} supported model) (Depending on model)

Control buttons (, , , ,) Controls media contents.

⬤ ⬤ ⬤ ⬤ These access special functions in some menus.



- Do not mix new batteries with old batteries. This may cause the batteries to overheat and leak.
- Failure to match the correct polarities of the battery may cause the battery to burst or leak, resulting in fire, personal injury, or ambient pollution.
- This apparatus uses batteries. In your community there might be regulations that require you to dispose of these batteries properly due to environmental considerations. Please contact your local authorities for disposal or recycling information.
- Batteries inside or inside the product shall not be exposed to excessive heat such as sunshine, fire or the like.

Settings

Automatically Setting Up Programme

⚙️ (Settings) ⇒ Programmes ⇒ Auto Tuning

Automatically tunes the programmes.

- If Input Source is not connected properly, programme registration may not work.
- **Auto Tuning** only finds programmes that are currently broadcasting.
- If **Lock System** is turned on, a pop-up window will appear asking for password.
- Supported DTV Audio : MPEG, Dolby Digital, Dolby Digital Plus, HE-AAC

To select Picture Mode

⚙️ (Settings) ⇒ Picture ⇒ Picture Mode Settings ⇒ Picture Mode

Select the picture mode optimized for the viewing environment or the programme.

- **Vivid** : Heightens contrast, brightness and sharpness to display vivid images.
- **Standard** : Displays images in standard levels of contrast, brightness and sharpness.
- **Eco/APS** : [Depending on model]
The Energy Saver feature changes settings on the TV to reduce power consumption.
- **Cinema/Game** : Displays the optimum picture for movie, game.
- **Soccer** : [Depending on model]
Optimizes the video image for high and dynamic actions by emphasizing primary colours such as white, grass, or sky blue.
- Depending on input signal, available range of picture modes may differ.

Fine-tuning Picture Mode

⚙️ (Settings) ⇒ Picture ⇒ Picture Mode Settings

This feature allows you to adjust the selected picture mode in detail.

- **Backlight** : Controls the level of screen brightness by adjusting the backlight. The closer to 100, the brighter the screen.
- **Contrast** : Adjusts the contrast of the bright and dark areas of the picture. The closer to 100, the higher the contrast.
- **Brightness** : Adjusts the overall screen brightness. The closer to 100, the brighter the screen.
- **Sharpness** : Adjusts the sharpness of the image. The closer to 50, the sharper and clearer the image.
- **Colour** : Tones down or up the colours displayed on the screen. The closer to 100, the deeper the colour.
- **Tint** : Adjusts the colour balance between red and green displayed on the screen. The closer to Red 50, the more red the colour will be. The closer to Green 50, the more green the colour will be.
- **Colour Temperature** : Adjusts the colour temperature from cold to warm.
- Depending on input signal or other picture settings, the range of detailed items for adjustment may differ.

To set advanced controls

⚙️ (Settings) ⇒ Picture ⇒ Picture Mode Settings ⇒ Advanced Controls / Expert Controls

Calibrates the screen for each picture mode; or adjusts picture settings for a special screen.

- **Dynamic Contrast** : Adjusts the contrast to the optimal level according to the brightness of the image.
- **Dynamic Colour** : Adjusts colours to make the image appear in more natural colours.
- **Gamma** : Sets the gradation curve according to the output of picture signal in relation to the input signal.
- Depending on input signal or other picture settings, the range of detailed items for adjustment may differ.

To set additional picture options

⚙️ (Settings) ⇨ Picture ⇨ Picture Mode Settings ⇨ Picture Options

Adjusts detailed setting for images.

- **Noise Reduction** : Eliminates noise in the picture.
- **Digital Noise Reduction** : Eliminates noise generated while creating digital picture signals.
- **Black Level** : Adjusts the brightness and contrast of the screen to suit the black level of the input picture by using the blackness (black level) of the screen.
- **Real Cinema** : Optimizes the screen for movie viewing.
- Depending on input signal or other picture settings, the range of detailed items for adjustment may differ.

Resetting picture settings

⚙️ (Settings) ⇨ Picture ⇨ Picture Mode Settings ⇨ Picture Reset

Resets picture settings that the user customizes. Each picture mode is reset. Select the picture mode you wish to reset.

To adjust Aspect Ratio

⚙️ (Settings) ⇨ Picture ⇨ Aspect Ratio

Selects the screen aspect ratio.

- **Original** : Changes the aspect ratio to 4:3 or 16:9 depending on the input video signal.
- **4:3** : Displays an aspect ratio of 4:3.
- **16:9** : Displays an aspect ratio of 16:9.
- **14:9** : You can view a picture format of 14:9 or a general TV programme in the 14:9 mode. The 14:9 screen is viewed in the same way as in 4:3, but is moved up or down.
- **Zoom** : Resizes images to fit the screen width. The top and bottom parts of the image may be cut off.
- **Full Wide** : When TV receives the wide screen signal, it will let you adjust the picture horizontally or vertically, in a linear proportion, to fill the entire screen fully. 4:3 and 14:9 video is supported in full screen without any video distortion through DTV input.
 - In Analogue/DTV/AV/Scart mode, **Full Wide** is available.
- **Just Scan** : Displays video images in the original size without removing parts of the edge of the image.
 - In DTV, Component, HDMI, and DVI (over 720p) mode, **Just Scan** is available.

To use Energy Saving feature

⚙️ (Settings) ⇨ Picture ⇨ Energy Saving

Reduces power consumption by adjusting screen brightness.

- **Off** : Turns off the Energy Saving mode.
- **Minimum / Medium / Maximum** : Applies the pre-set Energy Saving mode.
- **Screen Off** : Screen is turned off and only sound is played. Press any button except Power button on the remote control to turn the screen back on.

To use Picture Test

⚙️ (Settings) ⇨ Picture ⇨ Picture Test

First of all, start the **Picture Test** to see whether the video signal output is normal, and then select whether there is an error.

If there are no problems in the test, check the connected external device or broadcast signal.

Selecting Sound Mode

⚙️ (Settings) ⇨ Sound ⇨ Sound Mode Settings ⇨ Sound Mode

Adjusts TV audio to an optimal level based on a selected sound mode.

- **Standard** : Optimizes the sound for all types of content.
- **News** : Boosts voice clarity from the TV.
- **Music** : [Depending on model] Optimizes the sound for music.
- **Cinema** : Optimizes the sound for cinemas.
- **Soccer** : [Depending on model] Optimizes the sound for sports.
- **Game** : Optimizes the sound for gameplay.

Adjusting audio balance

⚙️ (Settings) ⇨ Sound ⇨ Sound Mode Settings ⇨ Balance

Adjust the volume of the left and right speakers.

Using the Sound Effect function

⚙️ (Settings) ⇒ Sound ⇒ Sound Mode Settings

The user can select various sound effects.

- **Treble** : Controls the dominant sounds in the output.
- **Bass** : Controls the softer sounds in the output.
- **Reset** : Reset the sound effect settings.
 - This is only available if **Sound Mode** is set to **Standard**.

To set Auto Volume

⚙️ (Settings) ⇒ Sound ⇒ Auto Volume

Sets **Auto Volume** to **On**. Varying volume output from programme to programme is automatically adjusted for convenient TV watching when clicking through different programme.

To use Sound Test

⚙️ (Settings) ⇒ Sound ⇒ Sound Test

Start the **Sound Test** to check that the sound signal output is normal, and then select whether there is an error.

If there are no problems in the test, check the connected external device or broadcast signal.

Using Manual Tuning

⚙️ (Settings) ⇒ Programmes ⇒ Manual Tuning

Adjusts programmes manually and saves the results.

For digital broadcasting, signal strength and signal quality can be checked.

For analogue broadcasting, you can set up station names and use fine tuning (except for Satellite mode). Normally fine tuning is only necessary if reception is poor.

Editing programmes

⚙️ (Settings) ⇒ Programmes ⇒ Programme Manager

Edits the saved programmes.

Set as favourite programme, block/unblock programme, skip programme etc. of the selected programme.

To select Programme mode

⚙️ (Settings) ⇒ Programmes ⇒ Programme Mode

[This feature is available on certain models only.]

This function allows you to watch a tuned programme in **Antenna** or **Cable**.

- You can only watch programmes in the selected mode.

Data Service Function

⚙️ (Settings) ⇒ Programmes ⇒ Data Service

[This feature is available in certain countries only.]

This function allows users to choose between MHEG (Digital Teletext) and Teletext if both exist at the same time.

If only one of them exists, either MHEG or Teletext is enabled regardless of which option you selected.

To use Signal Test

⚙️ (Settings) ⇒ Programmes ⇒ Signal Test

[This function is available on certain models or in certain countries only]

Shows the MUX and Service information etc..

Signal test is only available in **Antenna** or **Cable** mode.

To set Language

⚙️ (Settings) ⇨ General ⇨ Language

You can select the language of the menu displayed on the screen and the digital sound broadcasting.

- **Menu Language** : Selects a language for the display text.
- **Primary Audio Language / Secondary Audio Language** : [In Digital mode Only][The configurable items differ depending on country.] Selects the desired language when watching digital broadcasting containing several voice languages.
- **Teletext Language** : [In Digital mode Only][The configurable items differ depending on country.] Use the Text language function when two or more Text languages are broadcast.
- If teletext data in a selected language is not broadcast, the default Text language will be displayed.
- If you select the wrong local country, teletext may not appear correctly on the screen and some problems may occur during teletext operation.

Setting the Location

⚙️ (Settings) ⇨ General ⇨ Broadcast Country

[This feature is available in certain countries only.]

Sets the country that the TV uses.

TV settings are changed according to the broadcast environment of the selected country.

- If the country setting is changed, the **Auto Tuning** information screen may appear.
- In a country that Digital broadcasting regulation isn't fixed, some DTV functions may not work depending on digital broadcasting circumstances.

To set current time

⚙️ (Settings) ⇨ General ⇨ Time & Date

Checks or changes the time while watching TV.

- **Set Automatically** : Synchronizes the TV clock to the digital time information sent by the TV station.
- **Time / Date / Time Zone** : [Depending on Country] Sets the time and date manually if the auto setup does not correspond to the current time.
- **Custom Time Zone** : [Depending on Country] When select the Custom in Time Zone, Custom Time Zone menu is activated.

To use Sleep Timer

⚙️ (Settings) ⇨ General ⇨ Timers ⇨ Sleep Timer

Turns off the TV after a preset number of minutes.

To cancel the **Sleep Timer**, select **Off**.

To set the TV to turn on and off automatically

⚙️ (Settings) ⇨ General ⇨ Timers ⇨ Timer Power On / Timer Power Off

You can set the Power On/Off time for the TV.

Select **Off** if you are not going to set **Timer Power On / Timer Power Off**.

- To use **Timer Power On / Timer Power Off**, set the current time correctly.
- Even when the **Timer Power On** function is on, the TV will turn off automatically in 120 minutes when no button is pressed within that time.

To set Auto Power Off

⚙️ (Settings) ⇨ General ⇨ Timers ⇨ Auto Power Off

[This function is available on certain models or in certain countries only]

If you do not press any button on the TV or remote control for a certain period, the TV will automatically switch to standby mode.

- This function does not work on **Store Mode** or while **Software Update**.

Changing the TV Mode

⚙️ (Settings) ⇨ General ⇨ Home/Store Mode

Selects **Home Mode** or **Store Mode**.

When in use in home, please select **Home Mode**.

Store Mode is for store display.

To specify Factory Reset

⚙️ (Settings) ⇨ General ⇨ Reset to Initial Settings

All stored information is deleted and TV settings are reset.

TV turns itself off and back on, and all settings are reset.

- When **Lock System** is in place, a pop-up window appears and asks for password.
- Do not turn off the power during initialization.

Requesting service

⚙️ (Settings) ⇨ General ⇨ About This TV

For information on requesting service, refer to the TV's menu.

To lock system

⚙️ (Settings) ⇨ Safety ⇨ Lock System

Permits only specific programmes by blocking programmes or external input.

First set **Lock System to On**.

- **Programme Locks** : Blocks programmes with content inappropriate for children. Programmes can be selected but the screen is blank and the audio is muted. To watch a locked programme, enter the password.
- **TV Rating Locks** : This function operates according to information from the broadcaster. Therefore if the signal has incorrect information, this function does not operate. Prevents children from watching certain adult TV programmes according to the ratings limit set. Enter a password to watch a blocked programme. Ratings differ by country.
- **Input Block** : Block the input sources.

To set password

⚙️ (Settings) ⇨ Safety ⇨ Set Password

Sets or changes the TV password.

The initial password is set to '0000'.

To set Subtitle

⚙️ (Settings) ⇨ Accessibility ⇨ Subtitles

View subtitles when the TV station provides subtitled programming.

Change **Subtitles to On** and select subtitle setting.

- Applies to digital broadcasting.

To set Hard of Hearing

⚙️ (Settings) ⇨ Accessibility ⇨ Hard of Hearing

[This feature is available in certain countries only.]

This function is used for the hearing impaired. If it is set to on, the subtitle is displayed by default.

To set Audio Description

⚙️ (Settings) ⇨ Accessibility ⇨ Audio Description

This function is for the blind, and provides explanatory audio describing the current situation in a TV programme in addition to the basic audio.

When **Audio Description** is selected **On**, basic audio and Audio Description are provided only for those programmes that have Audio Description included.

To use My Media

Connect the USB storage device to the TV's **USB IN** terminal.

Selects a file from the list. Displays the file that you choose.

Sets play related settings by checking option during disk playback.

To remove the USB device

Q.MENU ⇨ USB Device

Select a USB storage device that you want to remove.

When you see a message that the USB device has been removed, separate the device from the TV.

- Once a USB device has been selected for removal, it can no longer be read. Remove the USB storage device and then re-connect it.

Using a USB storage device - warning

- If the USB storage device has a built-in auto recognition programme or uses its own driver, it may not work.
- Some USB storage devices may not work or may work incorrectly.
- Use only USB storage devices formatted with the Windows FAT32 or NTFS File System.
- For external USB HDDs, it is recommended that you use devices with a rated voltage of less than 5 V and a rated current of less than 500 mA.
- It is recommended that you use USB memory sticks of 32 GB or less and USB HDDs of 2 TB or less.
- If a USB HDD with power-saving function does not work properly, turn the power off and on. For more information, refer to the user manual of the USB HDD.
- Data in the USB storage device can be damaged, so be sure to back up important files to other devices. Data maintenance is the user's responsibility and the manufacturer is not responsible for data loss.

My Media supporting file

- External supported subtitle formats : .srt (SubRip), .ass/.ssa (SubStation Alpha), .smi (SAMI), .sub (SubViewer¹, MicroDVD, DVDsubtitleSystem, Subidx(Vobsub)), .txt (TMPlayer)
 - Internal supported subtitle formats: .dat/.mpg/.mpeg/.vob (DVD Subtitle), .ts/.trp/.tp (DVB Subtitle), .mp4 (DVD Subtitle, UTF-8 Plain Text), .mkv (ASS, SSA, UTF-8 Plain Text, VobSub, DVD Subtitle), .avi (XSUB, XSUB⁺)
- 1 SubViewer : Supports subtitles generated SubViewer 1.0 & 2.0 Only

Supported Video Formats

- Maximum : 1920 x 1080 @ 30p (Only Motion JPEG 640 x 480 @ 30p)

Extension	Codec	
.mpg, .mpeg	Video	MPEG-1, MPEG-2
	Audio	MPEG1/2 Layer3, AC3, AAC, LPCM
.avi	Video	MJPEG, MPEG-4, H.263, XVID, H.264
	Audio	MPEG1/2 Layer3, AC3, AAC, LPCM
.ts	Video	MPEG-2, H.264
	Audio	MPEG1/2 Layer3, AC3, AAC, LPCM
.mov, .mkv	Video	MPEG-4, H.263, H.264
	Audio	MPEG1/2 Layer3, AC3, AAC, LPCM
.dat	Video	MPEG-1
	Audio	MPEG1/2 Layer3, AC3, AAC, LPCM
.mp4	Video	MPEG-4, H.264, MPEG-1, MPEG-2
	Audio	MPEG1/2 Layer3, AC3, AAC, LPCM
.vob	Video	MPEG-2
	Audio	MPEG1/2 Layer3, AC3, AAC, LPCM
.flv	Video	Sorenson H.263, H.264
	Audio	MPEG1/2 Layer3, AAC

Supported Audio Formats

Extension	Item	Info
.mp3	Bit rate	32 Kbps - 320 Kbps
	Sample rate	16 kHz - 48 kHz
	Support	MPEG1/2 Layer3
.ac3	Bit rate	32 Kbps - 640 Kbps
	Sample rate	32 KHz, 44.1 KHz, 48 KHz
	Support	AC3
.m4a/.aac	Sample rate	8 kHz - 48 kHz
	Support	AAC
.flac	Bit rate	<1.6 Mbps
	Sample rate	8 kHz - 48 kHz
	Support	FLAC
.wav	Bit rate	64 Kbps ~ 1.5 Mbps
	Sample rate	8 kHz - 48 kHz
	Support	PCM
.flv	Bit rate	8 Kbps ~ 320 Kbps
	Sample rate	16 kHz - 48 kHz, 8 kHz - 48 kHz
	Support	MPEG1/2 Layer3, AAC

- When moving to a folder containing videos while playing music, the music may stop playing.

Supported Photo Formats

Extension	Item	Resolution
.jpg	Available file type	Progressive JPEG
	Photo size	Minimum : 2 (W) x 2 (H), Maximum : 1,024 (W) x 768 (H)
.jpeg	Available file type	Baseline JPEG
	Photo size	Minimum : 2 (W) x 2 (H), Maximum : 15,360 (W) x 8,640 (H)
.bmp	Available file type	BMP
	Photo size	Minimum : 2 (W) x 2 (H), Maximum : 9,600 (W) x 6,400 (H)
	Pixel Depth	1/4/8/16/24/32 bpp
.png	Available file type	Interlace, Non-Interlace
	Photo size	Minimum : 2 (W) x 2 (H) Maximum (Interlace) : 1,200 (W) x 800 (H), Maximum (Non-Interlace) : 9,600 (W) x 6,400 (H)

- BMP and PNG format files may be slower to display than JPEG

Troubleshooting

Cannot control the TV with the remote control.

- Check the remote control sensor on the product and try again.
- Check if there is any obstacle between the product and the remote control.
- Check if the batteries are still working and properly installed (⊕ to ⊕, ⊖ to ⊖).

No image display and no sound is produced.

- Check if the product is turned on.
- Check if the power cord is connected to a wall outlet.
- Check if there is a problem in the wall outlet by connecting other products.

The TV turns off suddenly.

- Check the power control settings. The power supply may be interrupted.
- Check if the auto-off function is activated on the settings related time.
- If there is no signal while the TV is on, the TV will turn off automatically after 15 minutes of inactivity.

When connecting to the PC (HDMI), no signal is detected.

- Turn the TV off/on using the remote control.
- Reconnect the HDMI cable.
- Restart the PC with the TV on.

Abnormal Display

- If the product feels cold to the touch, there may be a small “flicker” when it is turned on. This is normal, there is nothing wrong with product.
- This panel is an advanced product that contains millions of pixels. You may see tiny black dots and/or brightly coloured dots (red, blue or green) at a size of 1 ppm on the panel. This does not indicate a malfunction and does not affect the performance and reliability of the product. This phenomenon also occurs in third-party products and is not subject to exchange or refund.
- You may find different brightness and color of the panel depending on your viewing position(left/right/top/down). This phenomenon occurs due to the characteristic of the panel. It is not related with the product performance, and it is not malfunction.
- Displaying a still image for a prolonged period of time may cause image sticking. Avoid displaying a fixed image on the TV screen for a long period of time.

Generated Sound

- “Cracking” noise: A cracking noise that occurs when watching or turning off the TV is generated by plastic thermal contraction due to temperature and humidity. This noise is common for products where thermal deformation is required.
- Electrical circuit humming/panel buzzing: A low level noise is generated from a high-speed switching circuit, which supplies a large amount of current to operate a product. It varies depending on the product. This generated sound does not affect the performance and reliability of the product.

Specifications

(Depending on country)

Broadcasting Specifications		
	Digital TV (Depending on Country & Model)	Analogue TV (Depending on Country)
Television system	DVB-T/T2	PAL B/G, PAL D/K, PAL-I, SECAM-B/G, SECAM-D/K, NTSC-M
Programme coverage	VHF, UHF	VHF, UHF, CATV
Maximum number of storable programmes	600	200
External antenna impedance	75 Ω	

Environment condition	
Operating Temperature	0 °C to 40 °C
Operating Humidity	Less than 80 %
Storage Temperature	-20 °C to 60 °C
Storage Humidity	Less than 85 %

- The energy information provided with the product is indicated in accordance with the regulations of each country. (Depending on Country)
 - The Energy consumption is measured in accordance with IEC 62087.
- Actual Energy consumption may vary depending on factors such as the type of video content being played and TV settings.

HDMI-DTV supported mode

Resolution	Horizontal Frequency (kHz)	Vertical Frequency (Hz)
640 x 480p	31.47	59.94
	31.5	60.00
720 x 480p	31.47	59.94
	31.50	60.00
1280 x 720p	44.96	59.94
	45.00	60.00
720(1440) x 480i	15.73	59.94
	15.75	60.00
720 x 576p	31.25	50.00
1280 x 720p	37.5	50.00
720(1440) x 576i	15.63	50.00
1920 x 1080i	28.125	50.00
	33.72	59.94
	33.75	60.00
1920 x 1080p	26.97	23.976
	27.00	24.00
	33.716	29.976
	33.75	30.00
	56.25	50.00
	67.432	59.94
67.50	60.00	

HDMI-PC supported mode

Resolution	Horizontal Frequency (kHz)	Vertical Frequency (Hz)
720 x 400	31.469	70
640 x 480	31.469	59.940
800 x 600	35.156	56.250
	37.879	60.317
1024 x 768	48.363	60.004
1280 x 720	45.0	60
1280 x 768	47.776	59.870
1366 x 768	49.1	60
1280 x 960 ¹	60.0	60
1280 x 1024 ¹	63.9	60
1280 x 800 ¹	49.5	59.8
1680 x 1050 ¹	65.2	59.9
1920 x 1080 ¹	67.5	60

1 Only 43LK50*

Component port connecting information

Component ports on the TV	Y	P _B	P _R
Video output ports on DVD player	Y	P _B	P _R
	Y	B-Y	R-Y
	Y	Cb	Cr
	Y	Pb	Pr

Signal	Component
480i / 576i	0
480p / 576p	0
720p / 1080i	0
1080p	0 (Only 50 Hz / 60 Hz)

Resolution	Horizontal Frequency (kHz)	Vertical Frequency (Hz)
720 x 480i	15.73	60.00
720 x 480p	31.50	60.00
1440 x 576i	16.63	50.00
720 x 576p	31.50	50.00
1280 x 720p	37.50	50.00
	45.00	60.00
1920 x 1080i	28.13	50.00
	33.75	60.00
1920 x 1080p	56.25	50.00
	67.50	60.00

Licenses

Supported licenses may differ by model.

Manufactured under license from Dolby Laboratories. Dolby, Dolby Vision, Dolby Audio, Dolby Atmos, and the double-D symbol are trademarks of Dolby Laboratories.



The terms HDMI and HDMI High-Definition Multimedia Interface, and the HDMI Logo are trademarks or registered trademarks of HDMI Licensing Administrator, Inc. in the United States and other countries.

Regulatory







WARNING!

Never place a television set in an unstable location. A television set may fall, causing serious personal injury or death. Many injuries, particularly to children, can be avoided by taking simple precautions such as :

- Using cabinets or stands recommended by the manufacturer of the television set.
- Only using furniture that can safely support the television set.
- Ensuring the television set is not overhanging the edge of the supporting furniture.
- Not placing the television set on tall furniture (for example, cupboards or bookcases) without anchoring both the furniture and the television set to a suitable support.
- Not placing the television set on cloth or other materials that may be located between the television set and supporting furniture.
- Educating children about the dangers of climbing on furniture to reach the television set or its controls.

If your existing television set is being retained and relocated, the same considerations as above should be applied.

Symbols

	Refers to alternating current(AC).
	Refers to direct current(DC).
	Refers to class II equipment.
	Refers to stand-by.
	Refer to "ON" (power).
	Refers to dangerous voltage.

(Only Jordan)

WEEE



Disposal of your appliance

The symbol indicating separate collection for electrical and electronic equipment consists of the crossed-out wheeled bin.





Record the model number and serial number of the TV.
Refer to the label on the back cover and quote this
information to your dealer when requiring any service.

Model _____

Serial No. _____

For any Suggestion, Opinion,
Complaints, Please Call
800 54 in UAE
0800 545454 in South Africa
080 100 54 54 in Morocco
19960 in Egypt
021 36 54 54 in Algeria
Other countries, Please contact our
local dealer or log into
<http://www.lg.com>