

INSTALLATION MANUAL

AIR CONDITIONER

Please read this installation manual completely before installing the product. Installation work must be performed in accordance with the national wiring standards by authorized personnel only. Please retain this installation manual for future reference after reading it thoroughly.

Ceiling Concealed Duct



MFL67939920
Rev.02_012519

www.lg.com

Copyright © 2016 - 2019 LG Electronics Inc. All Rights Reserved.

TIPS FOR SAVING ENERGY

Here are some tips that will help you minimize the power consumption when you use the air conditioner. You can use your air conditioner more efficiently by referring to the instructions below:

- Do not cool excessively indoors. This may be harmful for your health and may consume more electricity.
- Block sunlight with blinds or curtains while you are operating the air conditioner.
- Keep doors or windows closed tightly while you are operating the air conditioner.
- Adjust the direction of the air flow vertically or horizontally to circulate indoor air.
- Speed up the fan to cool or warm indoor air quickly, in a short period of time.
- Open windows regularly for ventilation as the indoor air quality may deteriorate if the air conditioner is used for many hours.
- Clean the air filter once every 2 weeks. Dust and impurities collected in the air filter may block the air flow or weaken the cooling / dehumidifying functions.

For your records

Staple your receipt to this page in case you need it to prove the date of purchase or for warranty purposes. Write the model number and the serial number here:

Model number : _____

Serial number : _____

You can find them on a label on the side of each unit.

Dealer's name : _____

Date of purchase : _____

IMPORTANT SAFETY INSTRUCTIONS

READ ALL INSTRUCTIONS BEFORE USING THE APPLIANCE.

Always comply with the following precautions to avoid dangerous situations and ensure peak performance of your product

! WARNING

It can result in serious injury or death when the directions are ignored.

! CAUTION

It can result in minor injury or product damage when the directions are ignored.

! WARNING

- Installation or repairs made by unqualified persons can result in hazards to you and others.
- Installation **MUST** conform with local building codes or, in the absence of local codes, with the Nation Electrical Code NFPA 70/ANSI C1-1003 or current edition and Canadian Electrical Code Part1 CSA C.22.1.
- The information contained in the manual is intended for use by a qualified service technician familiar with safety procedures and equipped with the proper tools and test instruments.
- Failure to carefully read and follow all instructions in this manual can result in equipment malfunction, property damage, personal injury and/or death.

Installation

- Always perform grounding. - Otherwise, it may cause electrical shock.
- Don't use a power cord, a plug or a loose socket which is damaged. - Otherwise, it may cause a fire or electrical shock.
- For installation of the product, always contact the service center or a professional installation agency. - Otherwise, it may cause a fire, electrical shock, explosion or injury.
- Securely attach the electrical part cover to the indoor unit and the service panel to the outdoor unit. - If the electrical part cover of the indoor unit and the service panel of the outdoor unit are not attached securely, it could result in a fire or electric shock due to dust, water, etc.
- Always install an air leakage breaker and a dedicated switching board. - No installation may cause a fire and electrical shock.
- Do not keep or use flammable gases or combustibles near the air conditioner. - Otherwise, it may cause a fire or the failure of product.
- Ensure that an installation frame of the outdoor unit is not damaged due to use for a long time. - It may cause injury or an accident.
- Do not disassemble or repair the product randomly. - It will cause a fire or electrical shock.
- Do not install the product at a place that there is concern of falling down. - Otherwise, it may result in personal injury.
- Use caution when unpacking and installing. - Sharp edges may cause injury.
- Do not turn on the breaker or power under condition that front panel, cabinet, top cover, control box cover are removed or opened. - Otherwise, it may cause fire, electric shock, explosion or death.

Operation

- Do not share the outlet with other appliances. - It will cause an electric shock or a fire due to heat generation.
- Do not use the damaged power cord. - Otherwise, it may cause a fire or electrical shock.

4 IMPORTANT SAFETY INSTRUCTIONS

- Do not modify or extend the power cord randomly. - Otherwise, it may cause a fire or electrical shock.
- Take care so that the power cord may not be pulled during operation. - Otherwise, it may cause a fire or electrical shock.
- Unplug the unit if strange sounds, smell, or smoke comes from it. - Otherwise, it may cause electrical shock or a fire.
- Keep the flames away. - Otherwise, it may cause a fire.
- Take the power plug out if necessary, holding the head of the plug and do not touch it with wet hands. - Otherwise, it may cause a fire or electrical shock.
- Do not use the power cord near the heating tools. - Otherwise, it may cause a fire and electrical shock.
- Do not open the suction inlet of the indoor/outdoor unit during operation. - Otherwise, it may electrical shock and failure.
- Do not allow water to run into electrical parts. - Otherwise, it may cause the failure of machine or electrical shock.
- Hold the plug by the head when taking it out. - It may cause electric shock and damage.
- Never touch the metal parts of the unit when removing the filter. - They are sharp and may cause injury.
- Do not step on the indoor/outdoor unit and do not put anything on it. - It may cause an injury through dropping of the unit or falling down.
- Do not place a heavy object on the power cord. - Otherwise, it may cause a fire or electrical shock.
- When the product is submerged into water, always contact the service center. - Otherwise, it may cause a fire or electrical shock.
- Take care so that children may not step on the outdoor unit. - Otherwise, children may be seriously injured due to falling down.



CAUTION

Installation

- Install the drain hose to ensure that drain can be securely done. - Otherwise, it may cause water leakage.
- Install the product so that the noise or hot wind from the outdoor unit may not cause any damage to the neighbors. - Otherwise, it may cause dispute with the neighbors.
- Always inspect gas leakage after the installation and repair of product. - Otherwise, it may cause the failure of product.
- Keep level parallel in installing the product. - Otherwise, it may cause vibration or water leakage.

Operation

- Avoid excessive cooling and perform ventilation sometimes. - Otherwise, it may do harm to your health.
- Use a soft cloth to clean. Do not use wax, thinner, or a strong detergent. - The appearance of the air conditioner may deteriorate, change color, or develop surface flaws.
- Do not use an appliance for special purposes such as preserving animals vegetables, precision machine, or art articles. - Otherwise, it may damage your properties.
- Do not place obstacles around the flow inlet or outlet. - Otherwise, it may cause the failure of appliance or an accident.
- Means for disconnection must be incorporated in the fixed wiring in accordance with the wiring rules.

TABLE OF CONTENTS

2 TIPS FOR SAVING ENERGY

3 IMPORTANT SAFETY INSTRUCTIONS

6 INSTALLATION OF INDOOR

- 6 Selection of the best location
- 6 Ceiling dimension and hanging bolt location
- 9 Indoor Unit Drain Piping
- 9 Drain test
- 10 Heat insulation
- 10 Wiring Connection

12 REMOTE CONTROLLER INSTALLATION

- 13 Group Control

15 OPTIONAL OPERATION(Accessory)

- 15 Installer Setting - Test Run Mode
- 16 Installer Setting - Setting Address of Central Control
- 17 Installer Setting - Thermistor
- 18 Installer Setting - Remote Controller Master/Slave Setup
- 19 Installer Setting - Celsius/Fahrenheit Switching
- 20 Installer Setting - E.S.P.
- 21 Installer Setting - Static Pressure Step Setting

23 SELF-DIAGNOSIS FUNCTION / DIP SWITCH SETTING

INSTALLATION OF INDOOR

Selection of the best location

Install the air conditioner in the location that satisfies the following conditions.

- The place shall easily bear a load exceeding four times the indoor unit's weight.
- The place shall be able to inspect the unit as the figure.
- The place where the unit shall be leveled.
- The place shall easily connect with the outdoor unit.
- The place where the unit is not affected by an electrical noise.
- The place where air circulation in the room will be good.
- There should not be any heat source or steam near the unit.

Top view
Unit: mm

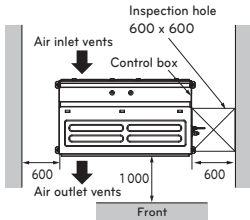

Front view
Unit: mm

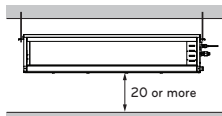

Top view
Unit: mm

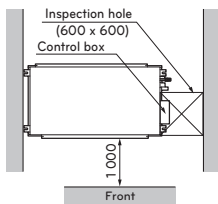

Front view
Unit: mm

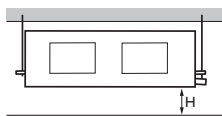

Ceiling dimension and hanging bolt location

Install the unit above the ceiling correctly.

CASE 1

Position of suspension Bolt

- Apply a joint-canvas between the unit and duct to absorb unnecessary vibration.
- Apply a filter Accessory at air return hole.

Ceiling Concealed Duct – Mid static pressure

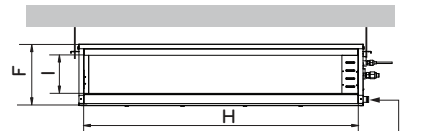
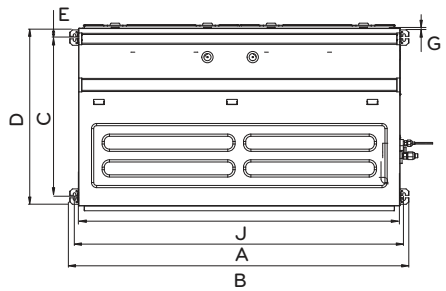

A

Drain hole

(Unit:mm)

Dimension \ Capacity (kBTu/h)	A	B	C	D	E	F	G	H	I	J
18 / 24 / 30	933.4	971.6	619.2	679	35	270	4.5	857	200	900
36 / 42	1283.4	1321.1	619.2	679	35	270	4.5	1206	200	1250
48 / 60	1283.4	1321.1	619.2	679	35	360	4.5	1206	291	1250

Confirm the positional relationship between the unit and suspension bolts.

- Installation the ceiling opening to clean the filter or service under the product.

Ceiling Concealed Duct - Compact

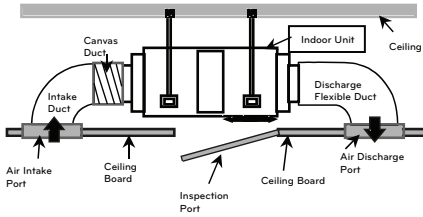
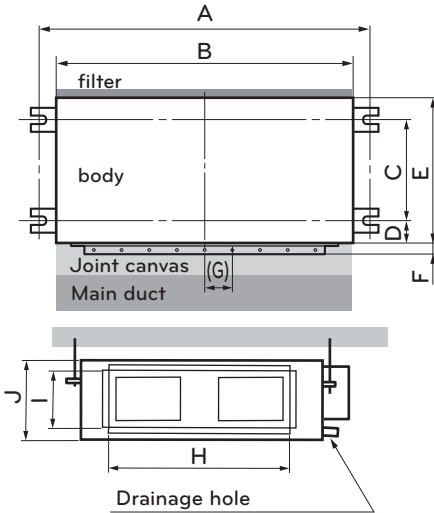

(Unit:mm)

Dimension	A	B	C	D	E	F	G	H	I	J
Capacity(kBtu/h)	932	882	355	46	450	30	87	750	163	260

CASE 2

- Install the unit leaning to a drainage hole side as a figure for easy water drainage.

Position of console Bolt

- A place where the unit will be leveled and that can support the weight of the unit.
- A place where the unit can withstand its vibration.
- A place where service can be easily performed.

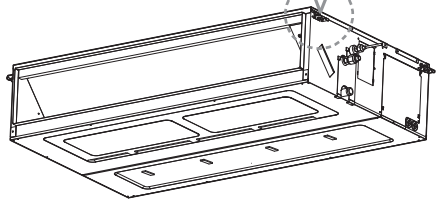
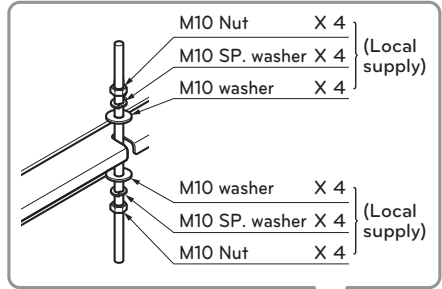

Select and mark the position for fixing bolts

- Drill the hole for set anchor on the face of ceiling.

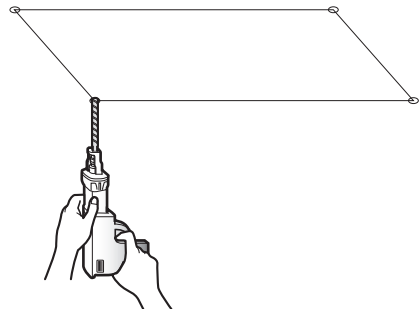

CAUTION

Tighten the nut and bolt to prevent unit falling.

- Insert the set anchor and washer onto the suspension bolts for locking the suspension bolts on the ceiling.
- Mount the suspension bolts to the set anchor firmly.
- Secure the installation plates onto the suspension bolts (adjust level roughly) using nuts, washers and spring washers.

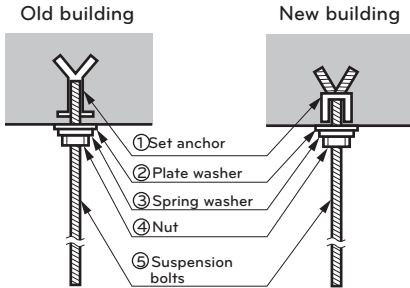

CAUTION

- Install declination of the indoor unit is very important for the drain of the duct type air conditioner.
- Minimum thickness of the insulation for the connecting pipe shall be 5 mm.
- The unit must be horizontal or declined to the drain hose connected when finished installation.

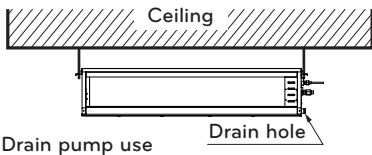
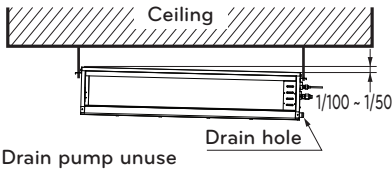

Caution for gradient of unit and drain piping

Lay the drain hose with a downward inclination so water will drain out.

- Always lay the drain with downward inclination (1/100 to 1/50). Prevent any upward flow or reverse flow in any part.
- 10 mm or thicker formed thermal insulator shall always be provided for the drain pipe.

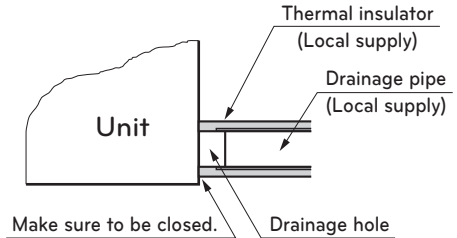

- Upward routing not allowed

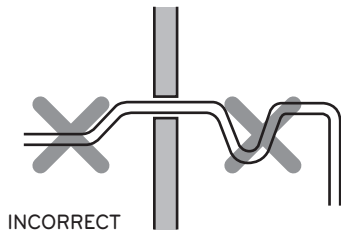
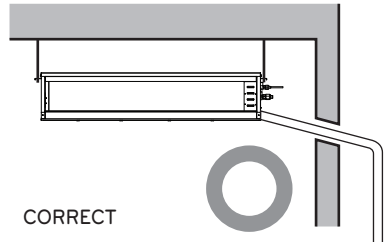

- Install the P-Trap (or U-Trap) to prevent a water leakage caused by the blocking of intake air filter.

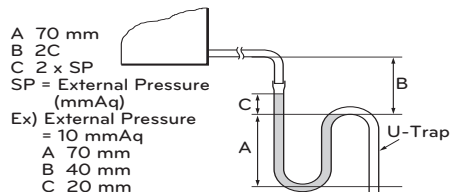

Indoor Unit Drain Piping

- Drain piping must have down-slope (1/50 to 1/100): be sure not to provide up-and-down slope to prevent reversal flow.
- During drain piping connection, be careful not to exert extra force on the drain port on the indoor unit.
- The outside diameter of the drain connection on the indoor unit is 32 mm.

Piping material: Polyvinyl chloride pipe VP-25 and pipe fittings

- Be sure to execute heat insulation on the drain piping.
- Install the drain raising pipes at a right angle to the indoor unit and no more than 300 mm from the unit.

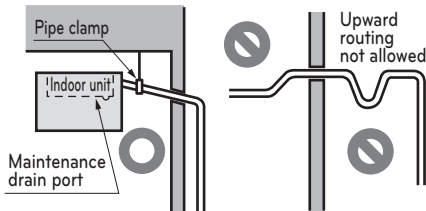

Heat insulation material: Polyethylene foam with thickness more than 8 mm.

Drain test

- Connect the main drain pipe to the exterior and leave it provisionally until the test comes to an end.
- Feed water to the flexible drain hose and check the piping for leakage.
- When the test is complete, connect the flexible drain hose to the drain port on the indoor unit.

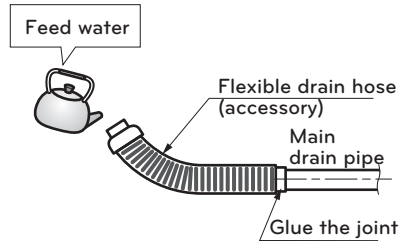

1 Remove the Air Filter.

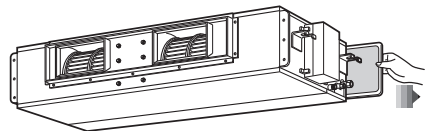
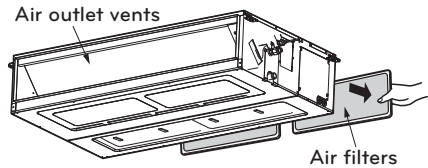

2 Check the drainage.

- Spray one or two glasses of water upon the evaporator.
- Ensure that water flows drain hose of indoor unit without any leakage.

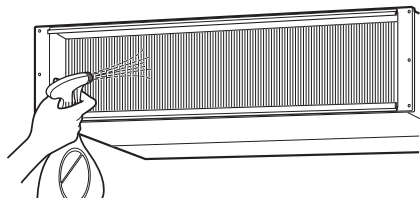

Heat insulation

- 1 Use the heat insulation material for the refrigerant piping which has an excellent heat-resistance (over 120 °C).
- 2 Precautions in high humidity circumstance: This air conditioner has been tested according to the "KS Standard Conditions with Mist" and confirmed that there is not any default. However, if it is operated for a long time in high humid atmosphere (dew point temperature: more than 23 °C), water drops are liable to fall. In this case, add heat insulation material according to the following procedure:
 - Heat insulation material to be prepared. Adiabatic glass wool with thickness 10 to 20 mm.
 - Stick glass wool on all air conditioners that are located in ceiling atmosphere.

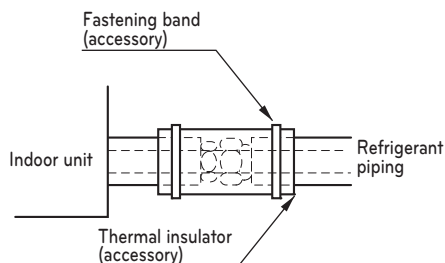

Wiring Connection

- Open the control box cover and connect the Remote controller wiring and Indoor power wires.
- Remove the control box cover for electrical connection between the indoor and outdoor unit. (Remove screws ①.)
- Use the cord clamer to fix the wiring.

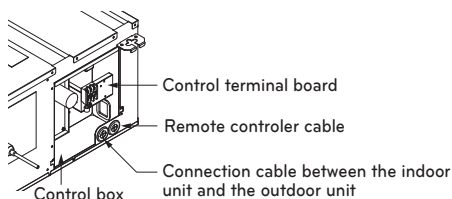
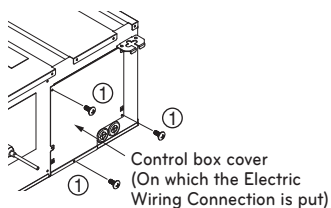

Connect the wires to the terminals on the control board individually according to the outdoor unit connection.

Ensure that the color of the wires of outdoor unit and the terminal No. are the same as those of indoor unit respectively

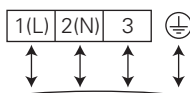

Connected to outdoor unit or B.D. unit.

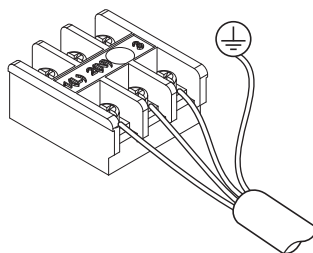

! CAUTION

The connecting wiring connected to the indoor and outdoor unit should be complied with the following specifications (This equipment shall be provided with a wiring set complying with the national regulation).

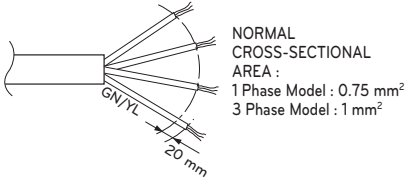

If the supply wiring is damaged, it must be replaced by a special wiring or assembly available from the manufacturer of its service agent.

When the connection line between the indoor unit and outdoor unit is over 40 m, connect the telecommunication line and power line separately.

! CAUTION

The Power cord connected to the unit should be selected according to the following specifications.

Precautions when laying power wiring

Use round pressure terminals for connections to the power terminal block.

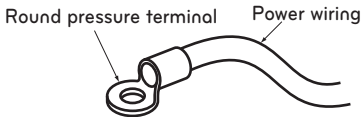

When none are available, follow the instructions below.

- Do not connect wiring of different thicknesses to the power terminal block. (Slack in the power wiring may cause abnormal heat.)
- When connecting wiring which is the same thickness, do as shown in the figure below.



REMOTE CONTROLLER INSTALLATION

1 Please fix tightly using provided screw after placing remote controller setup board on the place where you like to setup.

- Please set it up not to bend because poor setup could take place if setup board bends.

Please set up remote controller board fit to the reclamation box if there is a reclamation box.

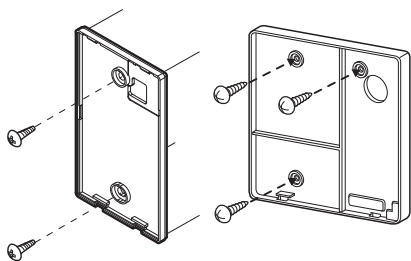

2 Can set up Wired remote controller cable into three directions.

- Setup direction: the surface of wall reclamation, upper, right
- If setting up remote controller cable into upper and right side, please set up after removing remote controller cable guide groove.

* Remove guide groove with long nose.

- ① Reclamation to the surface of the wall
- ② Upper part guide groove
- ③ Right part guide groove

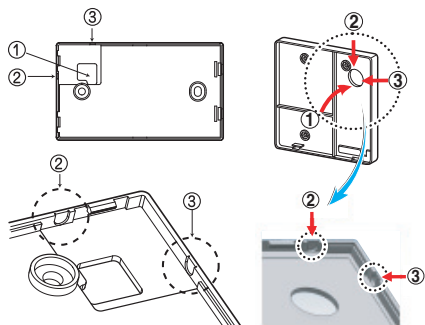

Since the room temperature sensor is in the remote controller, the remote controller box should be installed in a place away from direct sunlight, high humidity and direct supply of cold air to maintain proper space temperature. Install the remote controller about 5 ft(1.5 m) above the floor in an area with good air circulation at an average temperature.

Do not install the remote controller where it can be affected by:

- Drafts, or dead spots behind doors and in corners.
- Hot or cold air from ducts.
- Radiant heat from sun or appliances.
- Concealed pipes and chimneys.
- Uncontrolled areas such as an outside wall behind the remote controller.
- This remote controller is equipped with LCD display. For proper display of the remote controller LCD's, the remote controller should be installed properly as shown in Fig.1.
(The standard height is 4~5 ft (1.2~1.5 m) from floor level.)

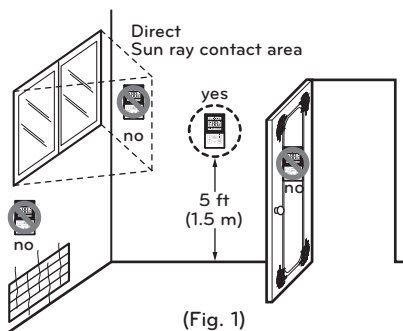

(Fig. 1)

- 3 Please connect indoor unit and remote controller using connection cable.

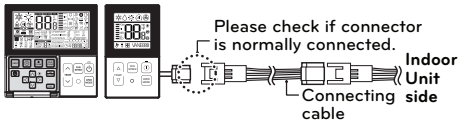

- 4 Please use extension cable if the distance between wired remote controller and indoor unit is more than 10 m.
- 5 Please fix remote controller upper part into the setup board attached to the surface of the wall, as the picture below, and then, connect with setup board by pressing lower part.
- Please connect not to make a gap at the remote controller and setup board's upper and lower, right and left part.

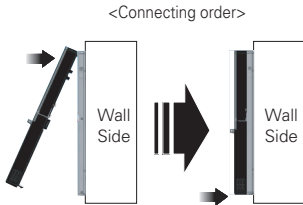

When separating remote controller from setup board, as the picture below, after inserting into the lower separating hole using screw driver and then, spinning clockwise, remote controller is separated.

- There are two separating holes. Please individually separate one at a time.
- Please be careful not to damage the inside components when separating.

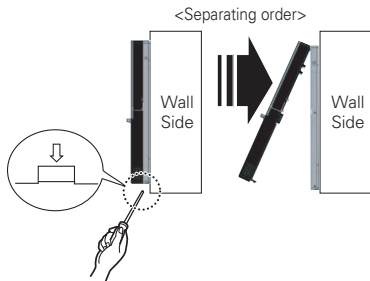

CAUTION

When installing the wired remote controller, do not bury it in the wall. (It can cause damage in the temperature sensor.)

Do not install the cable to be 50 m or above. (It can cause communication error.)

- When installing the extension cable, check the connecting direction of the connector of the remote controller side and the product side for correct installation.
- If you install the extension cable in the opposite direction, the connector will not be connected.
- Specification of extension cable: 2547 1007 2# 2 core 3 shield 5 or above.

Group Control

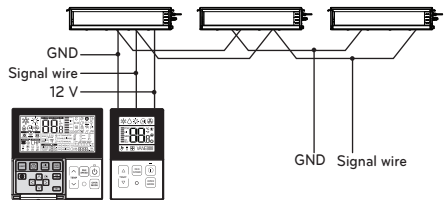

- When installing more than 2 units of air conditioner to one wired remote controller, please connect as the right figure.
 - If it is not event communication indoor unit, set the unit as slave.
 - Check for event communication through the product manual.
- When controlling multiple indoor units with event communication function with one remote controller, you must change the master/slave setting from the indoor unit.
 - Indoor units, the master/slave configuration of the product after completion of indoor unit power 'OFF' and then 'ON' the power after 1 minutes elapsed sign up.

- For ceiling type cassette and duct product group, change the switch setting of the indoor PCB.

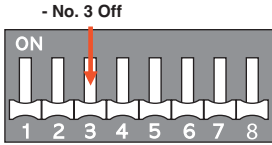

1 2 3 4 5 6 7 8

#3 switch OFF: Master
(Factory default setting)

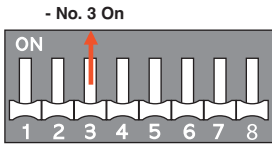

1 2 3 4 5 6 7 8

#3 switch ON: Slave

- For wall-mount type and stand type product, change the master/slave setting with the wireless remote controller. (Refer to wireless remote controller manual for detail)

- * When installing 2 remote controllers to one indoor unit with event communication function, set the master/slave of the remote controller. (Refer to remote controller master/slave selection)

When controlling the group, some functions excluding basic operation setting, fan level Min/Mid/Max, remote controller lock setting and time setting may be limited.

- 3 When installing more than 2 wired remote controllers to one air conditioner, please connect as the right picture.

- When installing more than 2 units of wired remote controller to one air conditioner, set one wired remote controller as master and the others all as slaves, as shown in the right picture.
- You cannot control the group as shown in the right for some products.
- Refer to the product manual for more detail.

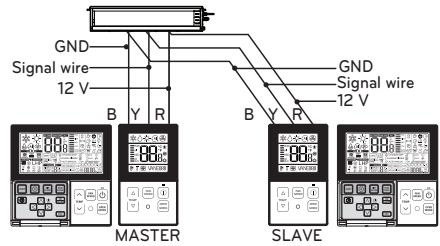

<When simultaneously connecting 2 sets of wired remote controller>

- When controlling in groups, set the master/slave of the remote controller. Refer to Installer setting section on how to set master/slave for more detail.

OPTIONAL OPERATION(Accessory)

Installer Setting - Test Run Mode

After installing the product, you must run a Test Run mode.

For details related to this operation, refer to the product manual.

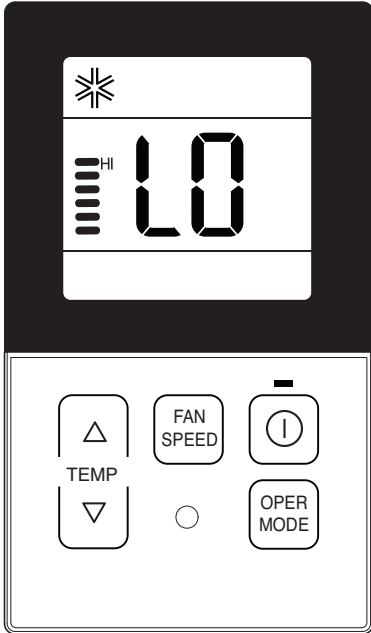

- 1** When pressing the button and button simultaneously for more than 3 seconds, the system will be entered into the installer setting mode.

 - After entering into the installer setting mode, select the test run mode code value by pressing the button.
 - * Test run mode code value : 01
- 2** When pressing the button, the test operation mode will be performed, and it is displayed as shown in the left figure.
- 3** When pressing the button and button simultaneously for more than 3 seconds after the setting has been completed, the setting mode will be released.

 - If there isn't any button input for more than 25 seconds, the installer setting mode will also be released.
- 4** When approx. 18 minutes are elapsed after starting of the test oper-mode, the system will be stopped automatically and converted to the standby state.

 - If any button is inputted during the test run mode, the test run mode will be forced to be released.

What is the test run mode??

- This means the operation of the product under the cooling, strong wind, and Comp on state without performing room temperature control in order to confirm the installed state during the product installation.

Installer Setting - Setting Address of Central Control

It's the function to use for connecting central control.

Please refer to central controller manual for the details.

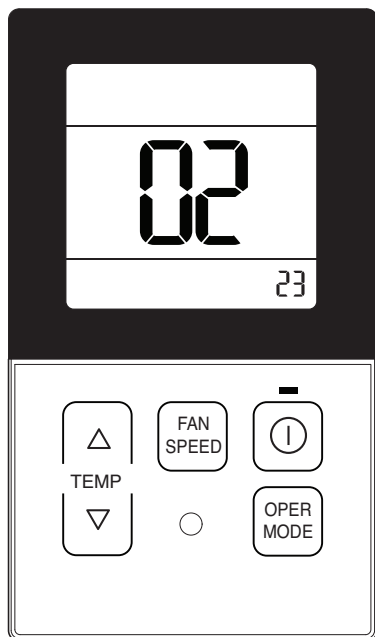

- If you connect the indoor unit to the central controller, you should set the network address of the indoor unit so that the central controller could recognize it.
- The center-control address is composed of the group number and the indoor-unit number.

NOTE

The remote controller displays 'HL' if central controller has locked the remote controller.

- 1 When pressing the button and button simultaneously for more than 3 seconds, the system will be entered into the installer setting mode.
 - After entering into the installer setting mode, select the central control address setting code value by pressing the button.
 - * Setting address of central control code value : 02

- 2 Set up the group number and indoor unit with the temperature adjustment(,) buttons.

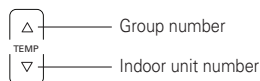

For example, when setting as
[Group number=2 Indoor number=3]
it will be displayed as shown in the left figure.

- 3 When pressing the button, the system will be set up with the address value which has been established at present.

- 4 When pressing the button and button simultaneously for more than 3 seconds after the setting has been completed, the setting mode will be released.
 - If there isn't any button input for more than 25 seconds, the installer setting mode will also be released.

* In the case when the lock is set up at the central controller, 'HL' will be indicated on the display window of the wired remote controller and the indoor unit will not be controlled by the remote controller.

Installer Setting - Thermistor

This is the function to select the temperature sensor to judge the room temperature.

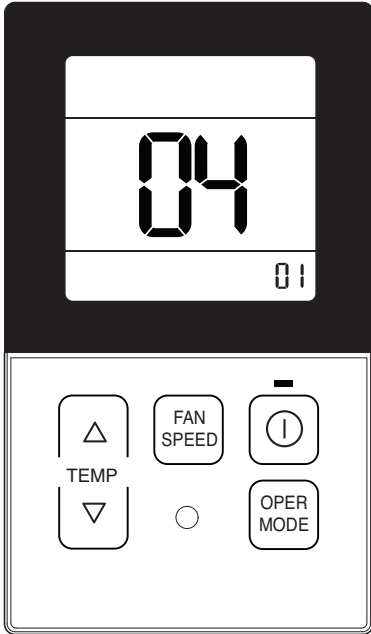

- When pressing the button and button simultaneously for more than 3 seconds, the system will be entered into the installer setting mode.

 - After entering into the installer setting mode, select the thermistor sensor setting code value by pressing the button.
 - * Thermistor sensor selection code value : 04

- Select the desired setting value with the temperature up() , down() button.

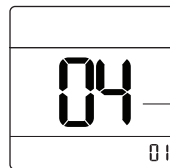

Code value

Value

*Setting value
01: Remote controller
02: Indoor unit
03: 2TH

- When pressing the button, currently established thermistor sensor location will be set up.

- When pressing the button and button simultaneously for more than 3 seconds after the setting has been completed, the setting mode will be released.

 - If there isn't any button input for more than 25 seconds, the installer setting mode will also be released.

* As the characteristic of the '2TH' function can be different in accordance with the products, refer to the product instruction manual for its detail.

Installer Setting - Remote Controller Master/Slave Setup

It is a function for settings in group control, or 2-remote controller control.

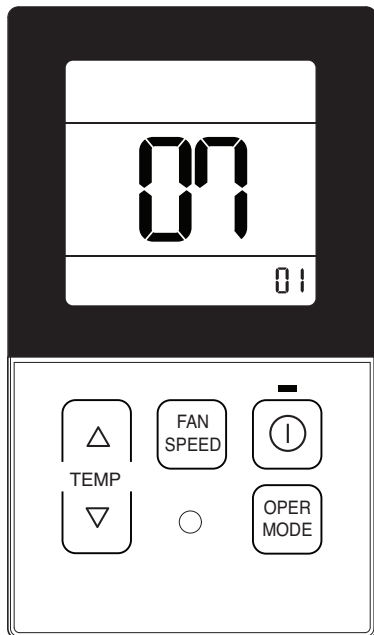

1 When pressing the button and button simultaneously for more than 3 seconds, the system will be entered into the installer setting mode.

- After entering into the installer setting mode, select the ceiling height setting code value by pressing the oper-mode button.

* Remote controller master/slave setting code value : 07

2 Select the desired setting value with the temperature up() , down() button.

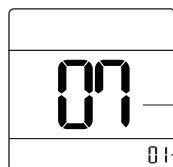

Code value

Value

*Setting value
00:Slave
01:Master

3 When pressing the button, currently established static pressure value will be set up.

4 When pressing the button and button simultaneously for more than 3 seconds after the setting has been completed, the setting mode will be released.
- If there isn't any button input for more than 25 seconds, the installer setting mode will also be released.

Remote controller	Function
Master	Indoor unit operates based on master remote controller at group control. (Master is set when delivering from the warehouse.)
Slave	Setup all remote controllers except one master remote controller to slave at group control.

* Refer to the 'group control' part for details

-When controlling in groups, basic operation settings, airflow strength weak/medium/strong, lock setting of the remote controller, time settings, and other functions may be restricted.

Installer Setting - Celsius/Fahrenheit Switching

This function is used for switching the display between Celsius and Fahrenheit.
(Optimized only for U.S.A)

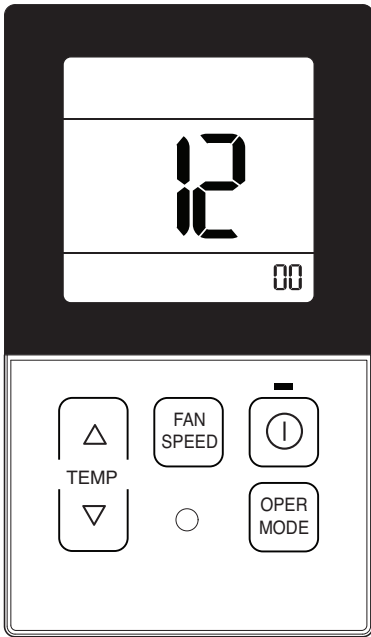

- 1 When pressing the button and button simultaneously for more than 3 seconds, the system will be entered into the installer setting mode.
- After entering into the installer setting mode, select the ceiling height setting code value by pressing the oper-mode button.
* Celsius/Fahrenheit setting code value : 12

- 2 Select the desired setting value with the temperature up(), down() button.

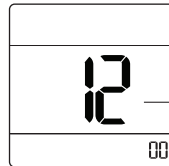

* Setting value
00:Celsius
01:Fahrenheit

- 3 When pressing button, currently established celsius/Fahrenheit setting value will be set up.

- 4 When pressing the button and button simultaneously for more than 3 seconds after the setting has been completed, the setting mode will be released.
- If there isn't any button input for more than 25 seconds, the installer setting mode will also be released.

- Whenever press temp up() , down() button in Fahrenheit mode, the temperature will increase/drop 2 degrees.

Installer Setting - E.S.P.

This is the function that decides the strength of the wind for each wind level and because this function is to make the installation easier.

- If you set ESP incorrectly, the air conditioner may malfunction.
- This setting must be carried out by a certificated-technician.

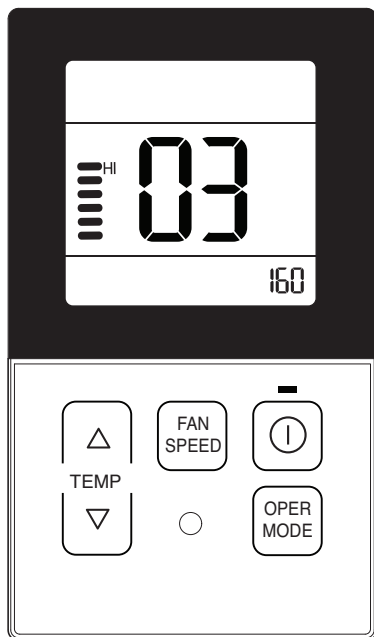

- 1 When pressing the button and button simultaneously for more than 3 seconds, the system will be entered into the installer setting mode.

 - After entering into the installer setting mode, select the E.S.P code value by pressing the button.
 - * E.S.P code value : 03
- 2 Select the desired air flow rate with the button. Whenever pressing the button, [Lo→Med→Hi] will be indicated.
- 3 Select the desired air flow rate value with the temperature up() , down() button.

 - * E.S.P value range : 0~255
 - E.S.P value will be indicated at the lower right section of the display window.
- 4 When pressing the button, currently established E.S.P value will be set up.
- 5 When pressing the button and button simultaneously for more than 3 seconds after the setting has been completed, the setting mode will be released.

 - If there isn't any button input for more than 25 seconds, the installer setting mode will also be released.

- Precaution shall be taken not to alter the E.S.P value corresponded to each air flow section.
- E.S.P value can be varied according to the products.
- In the case of going to the next air flow rate stage by pressing the fan-speed button during the setup of the E.S.P value, the E.S.P value of previous air flow rate will be maintained by remembering the E.S.P value prior to the shift.

Installer Setting - Static Pressure Step Setting

This function is applied to only duct type. Setting this in other cases will cause malfunction.

This function is only available on some products.

This is the function that static pressure of the product is divided in 11 steps for setting.

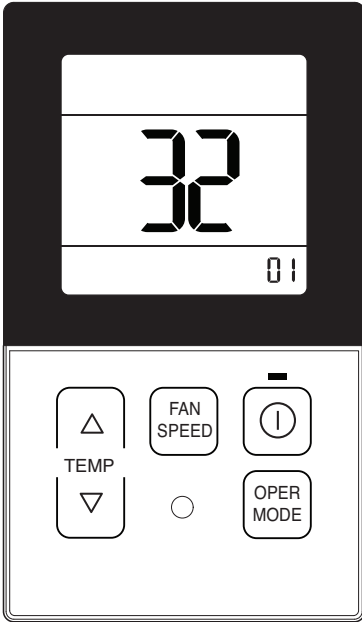

- 1** When pressing the button and button simultaneously for more than 3 seconds, the system will be entered into the installer setting mode.

 - After entering into the installer setting mode, select the static pressure step setting code value by pressing the button.

* Static pressure step setting code value : 32
- 2** Select the desired setting value with the temperature up(s), down(t) button.

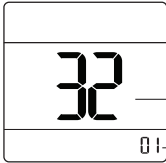

Code value

Value

00: use static pressure (code 06) set value
01~ 11: static pressure step (code 32) set value
- 3** When pressing button, currently established static pressure value will be set up.
- 4** When pressing the button and button simultaneously for more than 3 seconds after the setting has been completed, the setting mode will be released.

 - If there isn't any button input for more than 25 seconds, the installer setting mode will also be released.

- Static Pressure (Code 06) setting will not be used if Static Pressure Step (Code 32) setting is being used.

- For the static pressure value for each step, refer to the next page Table. 1

Ceiling Concealed Duct - Compact

Capacity	Step	C.M.M	Static Pressure(mmAq)					
			2.5	4	5	6	8	10
			Setting Value					
18 k	HIGH	13.5	102	112	119	125	-	-
	MID	12	96	106	114	119	-	-
	LOW	10.5	90	102	108	114	-	-
24 k	HIGH	18	121	131	137	142	-	-
	MID	16.5	115	125	130	135	-	-
	LOW	14	106	116	121	125	-	-

Ceiling Concealed Duct – Mid static pressure

Capacity	Step	CMM	Static Pressure[mmAq(Pa)]										
			2(20)	2.5(25)	3(29)	4(39)	6(59)	8(78)	10(98)	12(118)	13(127)	14(137)	15(147)
			Setting Value										
			32:01	32:02	32:03	32:04	32:05	32:06	32:07	32:08	32:09	32:10	32:11
18 k	LOW	13	73	74	77	88	93	103	111	117	120	125	128
	MID	14.5	76	77	85	91	97	107	114	121	125	128	131
	HIGH	16.5	85	87	90	94	103	110	118	125	128	131	134
24 k	LOW	14.5	76	77	85	89	97	107	114	121	125	128	131
	MID	16.5	85	87	90	94	103	110	118	125	128	131	134
	HIGH	18	90	92	95	99	108	115	122	129	132	135	138

Capacity	Step	CMM	Static Pressure[mmAq(Pa)]										
			2.5(25)	4(39)	5(49)	6(59)	7(69)	8(78)	9(88)	10(98)	11(108)	13(127)	15(147)
			Setting Value										
			32:01:00	32:02:00	32:03:00	32:04:00	32:05:00	32:06:00	32:07:00	32:08:00	32:09:00	32:10:00	32:11:00
30 k	LOW	18	96	102	107	110	114	118	122	125	127	132	134
	MID	20	102	110	114	118	121	125	127	130	133	135	137
	HIGH	22	110	117	121	124	127	130	133	136	137	138	140

Capacity	Step	CMM	Static Pressure[mmAq(Pa)]										
			4(39)	5(49)	6(59)	7(69)	8(78)	9(88)	10(98)	11(108)	12(118)	13(127)	15(147)
			Setting Value										
			32:01:00	32:02:00	32:03:00	32:04:00	32:05:00	32:06:00	32:07:00	32:08:00	32:09:00	32:10:00	32:11:00
36 k	LOW	24	88	91	95	100	101	108	113	115	118	121	128
	MID	28	93	97	101	105	108	115	118	120	124	127	134
	HIGH	32	101	105	109	112	115	119	123	126	128	133	137
48 k / 50 k	LOW	28	74	76	79	82	89	92	94	96	99	102	107
	MID	34	78	82	84	89	94	96	98	101	104	106	112
	HIGH	40	83	89	92	94	98	100	102	105	108	110	116
54 k / 60 k	LOW	40	82	89	92	94	98	100	102	105	108	110	113
	MID	45	90	92	96	98	102	104	106	109	112	114	117
	HIGH	50	94	97	100	104	107	109	112	115	117	119	121

SELF-DIAGNOSIS FUNCTION

Indoor Unit Error

Ex) Error 03 (Remote controller error)

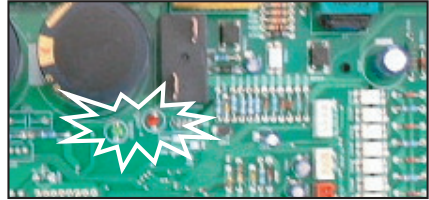
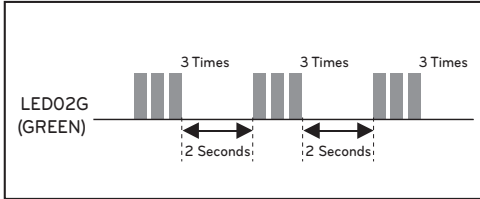

Error Code	Description	LED 1 (Red)	LED 2 (Green)	Indoor status
01	Indoor Room sensor error	0	1 time ●	OFF
02	Indoor in-pipe sensor error	0	2 times ●●	OFF
03	Remote controller error	0	3 times ●●●	OFF
04	Drain pump error	0	4 times ●●●●	OFF
05	Communication error indoor and outdoor	0	5 times ●●●●●	OFF
06	Indoor out-pipe sensor error	0	6 times ●●●●●●	OFF
09	EEPROM error (indoor)	0	9 times ●●●●●●●●●	OFF
10	BLDC motor fan lock (indoor)	1 time ●	0	OFF

* Because remote controller turn off when occur ERROR in simultaneous operation system, it should check LED blinks of outdoor in order to confirm error code.

* Repeatedly after LED 1 is turned on and off as the Error code number of tens digit, LED 2 is turned on and off as the Error code number of single-digit.

DIP SWITCH SETTING

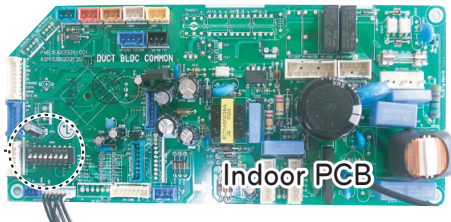
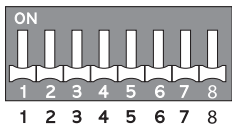

Function	Description	Setting Off	Setting On	Default	
SW3	Group Control	Selection of Master or Slave	Master	Slave	Off
SW4	Dry Contact Mode	Selection of Dry Contact Mode	Wired/Wireless remote controller Selection of Manual or Auto operation Mode	Auto	Off
SW5	Installation	Fan continuous operation	Continuous operation Removal	Working	Off

