



OWNER'S MANUAL

# LED LCD MONITOR

(LED Monitor\*)

\* LG LED Monitor applies LCD screen with LED backlights.

Please read this manual carefully before operating your set and retain it for future reference.

29WL500

34WL500

[www.lg.com](http://www.lg.com)

Copyright © 2019 LG Electronics Inc. All Rights Reserved.

# TABLE OF CONTENTS

LICENSE .....	2
ASSEMBLING AND PREPARING .....	3
USING THE MONITOR.....	8
USER SETTINGS .....	9
TROUBLESHOOTING .....	19
PRODUCT SPECIFICATION.....	21

# LICENSE

Each model has different licenses. Visit [www.lg.com](http://www.lg.com) for more information on the license.



The terms HDMI and HDMI High-Definition Multimedia Interface, and the HDMI Logo are trademarks or registered trademarks of HDMI Licensing Administrator, Inc.

# ASSEMBLING AND PREPARING



## CAUTION

- Always use genuine LG components to ensure safety and product performance.
- The product warranty will not cover damage or injury caused by the use of unauthorized components.
- It is recommended that use the supplied components.
- If you use generic cables not certified by LG, the screen may not display or there may be image noises.
- Illustrations in this document represent typical procedures, so they may look different from the actual product.
- Do not apply foreign substances (oils, lubricants, etc.) to the screw parts when assembling the product. (Doing so may damage the product.)
- Applying excessive force when tightening screws may cause damage to the monitor. Damage caused in this way will not be covered by the product warranty.
- Do not carry the monitor upside down by just holding the base. This may cause the monitor to fall off the stand and could result in personal injury.
- When lifting or moving the monitor, do not touch the monitor screen. The force applied to the monitor screen may cause damage to it.



## NOTE

- The components may look different from those illustrated here.
- Without prior notice, all product information and specifications contained in this manual are subject to change to improve the performance of the product.
- To purchase optional accessories, visit an electronics store or an online shopping site, or contact the retailer from which you purchased the product.
- The power cord provided may differ depending upon the region.

## Supported Drivers and Software

You can download and install the latest version from the LGE website ([www.lg.com](http://www.lg.com)).

Drivers and Software	Installation Priority
Monitor Driver	Recommended
OnScreen Control	Recommended
Dual Controller	Optional

## Product and Button Description

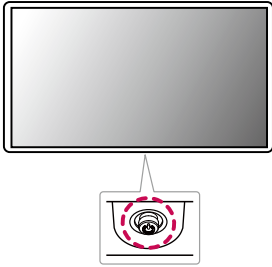

### How to Use the Joystick Button

You can easily control the functions of the monitor by pressing the joystick button or moving it left/right/up/down with your finger.

#### Basic Functions

		<b>Power on</b>	Press the joystick button once with your finger to turn on the monitor.
		<b>Power off</b>	Press and hold the joystick button once more than 5 seconds with your finger to turn off the monitor.
		<b>Volume control</b>	You can control the volume by moving the joystick button left/right.

#### NOTE

- The joystick button is located at the bottom of the monitor.

## Moving and Lifting the Monitor

When moving or lifting the monitor, follow these instructions to prevent the monitor from being scratched or damaged and to ensure safe transportation, regardless of its shape or size.

- Place the monitor in the original box or packing material before attempting to move it.
- Before moving or lifting the monitor, disconnect the power cord and all other cables.
- Hold the bottom and side of the monitor frame firmly. Do not hold the panel itself.
- When holding the monitor, the screen should face away from you to prevent it from being scratched.
- When transporting the monitor, do not expose the monitor to shock or excessive vibration.
- When moving the monitor, keep it upright and never turn the monitor on its side or tilt it sideways.

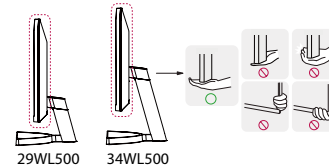

#### CAUTION

- Avoid touching the monitor screen as much as possible.
  - This may result in damage to the screen or some of the pixels used to create images.
- If you use the monitor panel without the stand base, its joystick button may cause the monitor to become unstable and fall, resulting in damage to the monitor or human injury. In addition, this may cause the joystick button to malfunction.

## Installing on a Table

- Lift the monitor and place it on the table in an upright position. Place the monitor at least 100 mm away from the wall to ensure sufficient ventilation.

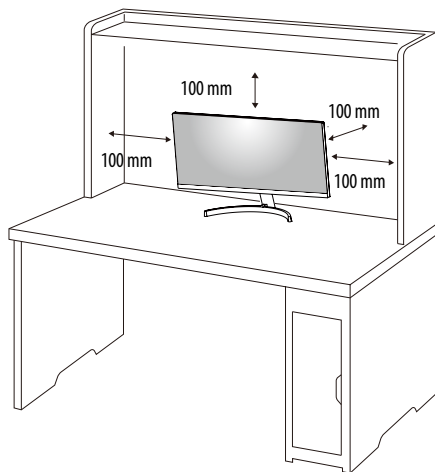

### CAUTION

- Unplug the power cord before moving or installing the monitor. There is risk of electric shock.
- Make sure to use the power cord that is provided in the product package and connect it to a grounded power outlet.
- If you need another power cord, please contact your local dealer or the nearest retail store.

## Adjusting the Angle

- 1 Place the monitor mounted on the stand base in an upright position.
- 2 Adjust the angle of the screen.

The angle of the screen can be adjusted forward or backward from  $-5^{\circ}$  to  $15^{\circ}$  for a comfortable viewing experience.

### WARNING

- To avoid injury to the fingers when adjusting the screen, do not hold the lower part of the monitor's frame as illustrated below.
- Be careful not to touch or press the screen area when adjusting the angle of the monitor.

29WL500

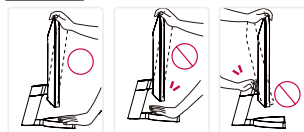

34WL500

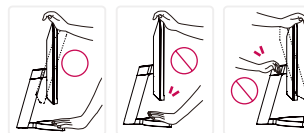

## Using the Kensington Lock

The connector for the Kensington security system is located at the bottom of the monitor.

For more information on installation and usage, refer to the Kensington lock owner's manual or visit the website at <http://www.kensington.com>.

Connect the monitor to a table using the Kensington security system cable.

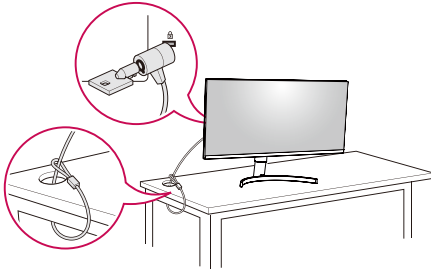

### ! NOTE

- The Kensington security system is optional. You can obtain optional accessories from most electronics stores.

## Installing the Wall Mount Plate

This monitor meets the specifications for the wall mount plate or other compatible devices.

### ! NOTE

- The wall mount plate is sold separately.
- For more information on installation, refer to the wall mount plate's installation guide.
- Be careful not to apply too much force while mounting the wall mount plate as it may cause damage to the screen.
- Remove the stand before installing the monitor on a wall mount by performing the stand attachment in reverse.

## Installing on the Wall

Install the monitor at least 100 mm away from the wall and leave about 100 mm of space at each side of the monitor to ensure sufficient ventilation. Detailed installation instructions can be obtained from your local retail store. Alternatively, please refer to the manual for how to install and set up a tilting wall mounting bracket.

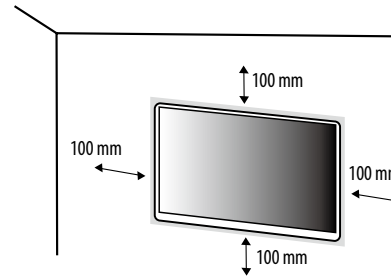

To install the monitor to a wall, attach a wall mounting bracket (optional) to the back of the monitor. Make sure that the wall mounting bracket is securely fixed to the monitor and to the wall.

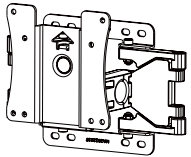
<b>Wall Mount (mm)</b>	100 x 100
<b>Standard screw</b>	M4 x L10
<b>Number of screws</b>	4
<b>Wall Mount Plate (Optional)</b>	LSW 149 

**NOTE**

- A non-VESA standard screw may damage the product and cause the monitor to fall. LG Electronics is not liable for any accidents relating to the use of non-standard screws.
- The wall mount kit includes the installation guide and all necessary parts.
- The wall mounting bracket is optional. You can obtain optional accessories from your local dealer.
- The length of the screw may differ for each wall mounting bracket. If you use screws longer than the standard length, it may damage the inside of the product.
- For more information, please refer to the user manual for the wall mounting bracket.

**CAUTION**

- Unplug the power cord before moving or installing the monitor to avoid electric shock.
- Installing the monitor on the ceiling or on a slanted wall may result in the monitor falling off, which could lead to injury. Use an authorized LG wall mount and contact the local dealer or qualified personnel.
- Applying excessive force when tightening screws may cause damage to the monitor. Damage caused in this way will not be covered by the product warranty.
- Use the wall mounting bracket and screws that conform to VESA standards. Damage caused by the use or misuse of inappropriate components will not be covered by the product warranty.
- When measured from the back of the monitor, the length of each installed screw must be 8 mm or less.

# USING THE MONITOR

- Illustrations in this manual may differ from the actual product.
- Press the joystick button, go to **Settings** → **Input**, and then select the input option.

## ⚠ CAUTION

- Do not press the screen for a prolonged time. This may cause image distortion.
- Do not display a still image on the screen for a prolonged time. This may cause image retention. Use a PC screensaver if possible.
- When connecting the power cord to the outlet, use a grounded (3-hole) power strip or a grounded power outlet.
- The monitor may flicker when turned on in an area where the temperature is low. This is normal.
- Sometimes red, green, or blue spots may appear on the screen. This is normal.

## Connecting to a PC

- This monitor supports the \*Plug and Play feature.
- \* Plug and Play: A feature that allows you to add a device to your computer without having to reconfigure anything or install any manual drivers.

### HDMI Connection

Transmits digital video and audio signals from your PC to the monitor.

## ⚠ CAUTION

- Using a DVI to HDMI / DP (DisplayPort) to HDMI cable may cause compatibility issues.
- Use a certified cable with the HDMI logo attached. If you do not use a certified HDMI cable, the screen may not display or a connection error may occur.
- Recommended HDMI cable types
  - High-Speed HDMI™ cable
  - High-Speed HDMI™ cable with Ethernet

## Connecting AV Devices

### HDMI Connection

HDMI transmits digital video and audio signals from your AV device to the monitor.

## ! NOTE

- Using a DVI to HDMI / DP (DisplayPort) to HDMI cable may cause compatibility issues.
- Use a certified cable with the HDMI logo attached. If you do not use a certified HDMI cable, the screen may not display or a connection error may occur.
- Recommended HDMI cable types
  - High-Speed HDMI™ cable
  - High-Speed HDMI™ cable with Ethernet

## Connecting Peripherals

### Headphones Connection

Connect peripherals to the monitor via the headphones port.

## ! NOTE

- Peripheral devices are sold separately.
- Depending on the audio settings of the PC and external device, headphones and speaker functions may be limited.
- If you use angled earphones, it may cause a problem with connecting another external device to the monitor. Therefore, it is recommended to use straight earphones.



Angled



Straight  
(Recommend)

# USER SETTINGS

## NOTE

- Your monitor's OSD (On Screen Display) may differ slightly from that shown in this manual.

## Activating the Main Menu



- 1 Press the joystick button on the bottom of the monitor.
- 2 Move the joystick up/down and left/right to set the options.
- 3 Press the joystick button once more to exit the main menu.

Button	Menu Status	Description
	<b>Main menu disabled</b>	Enables the main menu.
	<b>Main menu enabled</b>	Exits the main menu. (Holding down the button more than 5 seconds to turn off the monitor. You can turn off the monitor this way at any time, including when the OSD is on.)
	◀ <b>Main menu disabled</b>	Adjusts the monitor volume level.
	◀ <b>Main menu enabled</b>	Enters the <b>Input</b> features.
	▶ <b>Main menu disabled</b>	Adjusts the monitor volume level.
	▶ <b>Main menu enabled</b>	Enters the <b>Settings</b> feature.
	▲ <b>Main menu disabled</b>	Displays the information on the current input.
	▲ <b>Main menu enabled</b>	Turns off the monitor.
	▼ <b>Main menu disabled</b>	Displays the information on the current input.
	▼ <b>Main menu enabled</b>	Enters the <b>Picture Mode</b> feature.

## Main Menu Features

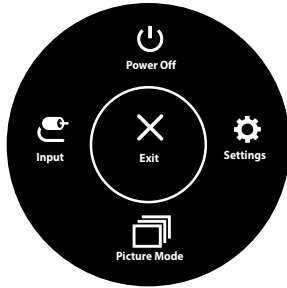

Main Menu	Description
<b>Input</b>	Sets input mode.
<b>Power Off</b>	Turns off the monitor.
<b>Settings</b>	Configures the screen settings.
<b>Picture Mode</b>	Sets the picture mode.
<b>Exit</b>	Exits the main menu.

## User Settings

### Menu Settings

- 1 To view the settings menu, press the joystick button at the bottom of the monitor and then enter the **Settings**.
- 2 Configure the options by moving the joystick up/down/left/right.
- 3 To return to the upper settings or set other settings items, move the joystick to ◀ or pressing (⏪) it.
- 4 If you want to exit the settings menu, move the joystick to ◀ until you exit.



Quick Settings



Input



Picture



General

### ⚠ CAUTION

- Your monitor's OSD (On Screen Display) may differ slightly from that shown in this manual.

Each option is described below.

Settings > Quick Settings	Description	
<b>Brightness</b>	Adjusts the color contrast and brightness of the screen.	
<b>Contrast</b>		
<b>Volume</b>	Adjusts the volume level.	
	<p><b>! NOTE</b></p> <ul style="list-style-type: none"> <li>You can adjust <b>Mute / Unmute</b> by moving the joystick button to ▼ in the <b>Volume</b> menu.</li> </ul>	
<b>Color Temp</b>	<b>Custom</b>	The user can adjust it to red, green, or blue by customization.
	<b>Warm</b>	Sets the screen color to a reddish tone.
	<b>Medium</b>	Sets the screen color between a red and blue tone.
	<b>Cool</b>	Sets the screen color to a bluish tone.

Settings > Input	Description	
<b>Input List</b>	Selects the input mode.	
<b>Aspect Ratio</b>	Adjusts the aspect ratio of the screen.	
	<b>Full Wide</b>	Displays the video in widescreen, regardless of the video signal input.
	<b>Original</b>	Displays video according to the aspect ratio of the video signal input.
	<b>Cinema 1</b>	Enlarges the screen with an aspect ratio of 21:9. (at 1080p)
	<b>Cinema 2</b>	Enlarges the screen with an aspect ratio of 21:9, including the black box at the bottom for subtitles. (at 1080p)
	<p><b>! NOTE</b></p> <ul style="list-style-type: none"> <li>There is no <b>Cinema 1</b>, <b>Cinema 2</b> settings on <b>FreeSync</b> Mode. ( Go to <b>Picture</b> → <b>Game Adjust</b> → <b>FreeSync</b>, to set <b>FreeSync On</b> or <b>Off</b>)</li> </ul>	

Settings > Picture	Description	
<b>Picture Mode</b>	<b>Custom</b>	Allows the user to adjust each element. The color mode of the main menu can be adjusted.
	<b>Vivid</b>	Heightens contrast, brightness and sharpness to display vivid images.
	<b>HDR Effect</b>	Optimizes the screen for high dynamic range.
	<b>Reader</b>	Optimizes the screen for viewing documents. You can brighten the screen in the settings menu.
	<b>Cinema</b>	Optimizes the screen for video.
	<b>FPS</b>	This mode is optimized for FPS games.
	<b>RTS</b>	This mode is optimized for RTS Game.
	<b>Color Weakness</b>	This mode is for users who cannot distinguish between red and green. It enables users with color weakness to easily distinguish between the two colors.
<p data-bbox="274 474 344 501"><b>!</b> NOTE</p> <ul data-bbox="274 512 954 535" style="list-style-type: none"> <li>• If the picture mode is changed in the screen may flicker or the resolution of your PC screen may be affected.</li> </ul>		

Settings > Picture	Description	
<b>Picture Mode</b>	<b>Custom</b>	Allows the user to adjust each element.
	<b>Vivid</b>	Optimized the screen for HDR vivid colors.
	<b>Standard</b>	Optimized the screen for HDR standard.
	<b>Cinema</b>	Optimized the screen for HDR video.
	<b>FPS</b>	This mode is optimized for FPS games.It is suitable for very dark FPS games.
	<b>RTS</b>	This mode is optimized for RTS Game.
	<p data-bbox="242 400 316 423"><b>NOTE</b></p> <ul data-bbox="242 434 1248 512" style="list-style-type: none"> <li>• HDR content may not display correctly depending on Window10 OS settings, please check HDR On/Off settings in Windows.</li> <li>• When the HDR function is turned on, the characters or picture quality may be poor according to Graphic card performance.</li> <li>• While the HDR function is on, screen flickering or cracking may occur when changing the monitor input or power on/off according to Graphic card performance.</li> </ul>	

Settings > Picture	Description		
Picture Adjust	<b>Brightness</b>	Adjusts the brightness of the screen.	
	<b>Contrast</b>	Adjusts the contrast of the screen.	
	<b>Sharpness</b>	Adjusts the sharpness of the screen.	
	<b>SUPER RESOLUTION+</b>	<b>High</b>	Optimized picture quality is displayed when a user wants crystal clear images. It is effective for high quality video or game.
		<b>Middle</b>	The optimized picture quality is displayed when a user wants images between low and high modes for comfortable viewing. It is effective for UCC or SD video.
		<b>Low</b>	The optimized picture quality is displayed when a user wants smooth and natural images. It is effective for slow-moving pictures or still images.
		<b>Off</b>	Select this option for everyday viewing. SUPER RESOLUTION+ is turned off in this mode.
		<p><b>NOTE</b></p> <ul style="list-style-type: none"> <li>Because this is a function to increase the sharpness of low resolution pictures, it is not recommended to use the function for normal text or for desktop icons. Doing so may result in unnecessarily high sharpness.</li> </ul>	
	<b>Black Level</b>	Sets the offset level (for HDMI only).	
		<ul style="list-style-type: none"> <li>Offset: as a reference for a video signal, this is the darkest color the monitor can display.</li> </ul>	
		<b>High</b>	Keeps the current contrast ratio of the screen.
	<b>DFC</b>	<b>On</b>	Adjust brightness automatically according to the screen.
		<b>Off</b>	Disables the DFC feature.

Settings > Picture	Description		
<b>Game Adjust</b>	<b>Response Time</b>	Sets a response time for displayed pictures based on the speed of the screen. For a normal environment, it is recommended that you use <b>Fast</b> . For a fast-moving picture, it is recommended that you use <b>Faster</b> . Setting to <b>Faster</b> may cause image sticking.	
		<b>Faster</b>	Sets the response time to Faster.
		<b>Fast</b>	Sets the response time to Fast.
		<b>Normal</b>	Sets the response time to Normal.
		<b>Off</b>	Does not use the response time improvement feature.
	<b>FreeSync</b>	Provides seamless and natural images by synchronizing the vertical frequency of the input signal with that of the output signal.   <b>CAUTION</b> <ul style="list-style-type: none"> <li>• Supported Interface: HDMI</li> <li>• Supported Graphic Card: A graphic card that supports AMD's FreeSync is necessary.</li> <li>• Supported Version: Make sure to update the graphic card to the latest driver.</li> <li>• For more information and requirement, refer to AMD website at <a href="http://www.amd.com/FreeSync">http://www.amd.com/FreeSync</a>.</li> </ul>	
		<b>On</b>	<b>FreeSync</b> function on.
		<b>Off</b>	<b>FreeSync</b> function off.
	<b>Black Stabilizer</b>	You can control the black contrast to have better visibility in dark scenes. Increasing the <b>Black Stabilizer</b> value brightens the low gray level area on the screen. (You can easily distinguish objects on dark game screens.) Reducing the <b>Black Stabilizer</b> value darkens the low gray level area and increases the dynamic contrast on the screen.	
	<b>Cross Hair</b>	Cross Hair provides a mark on the center of the screen for First Person Shooter (FPS) games. Users can select the <b>cross hair</b> that fits their gaming environment among four different <b>cross hairs</b> . <ul style="list-style-type: none"> <li>• When the monitor is off or enters energy saving mode, the Cross Hair feature is automatically turned <b>Off</b>.</li> </ul>	

Settings > Picture	Description		
<b>Color Adjust</b>	<b>Gamma</b>	<b>Mode 1, Mode 2, Mode 3</b>	The higher the gamma value, the darker the image becomes. Likewise, the lower the gamma value, the lighter the image becomes.
		<b>Mode 4</b>	If you do not need to adjust the gamma settings, select <b>Mode 4</b> .
	<b>Color Temp</b>	<b>Custom</b>	The user can adjust it to red, green, or blue by customization.
		<b>Warm</b>	Sets the screen color to a reddish tone.
		<b>Medium</b>	Sets the screen color between a red and blue tone.
		<b>Cool</b>	Sets the screen color to a bluish tone.
	<b>Red, Green, Blue</b>	You can customize the picture color using <b>Red, Green, and Blue</b> colors.	
	<b>Six Color</b>	Meets the user requirements for colors by adjusting the hue and saturation of the six colors (Red, Green, Blue, Cyan, Magenta, Yellow) and then saving the settings.	
		<b>Hue</b>	Adjusts the tone of the screen colors.
<b>Saturation</b>		Adjusts the saturation of the screen colors. The lower the value, the less saturated and brighter the colors become. The higher the value, the more saturated and darker the colors become.	
<b>Picture Reset</b>	<b>Do you want to reset your picture settings?</b>		<b>Yes</b> Returns to the default settings.
			<b>No</b> Cancel the select.

Settings > General	Description	
Language	Sets the menu screen to the desired language.	
SMART ENERGY SAVING	High	Saves energy using the high-efficiency <b>SMART ENERGY SAVING</b> feature.
	Low	Saves energy using the low-efficiency <b>SMART ENERGY SAVING</b> feature.
	Off	Disables the <b>SMART ENERGY SAVING</b> feature.
Power LED	On	The power LED turns on.
	Off	The power LED turns off.
Automatic Standby	Feature that automatically turns off the monitor when there is no movement on the screen for a period of time. You can set a timer for the auto-off function. (8 H, 6 H, 4 H and Off)	
HDMI Compatibility Mode	On	Enables <b>HDMI Compatibility Mode</b> .
	Off	Disables <b>HDMI Compatibility Mode</b> .
	<p><b>NOTE</b></p> <ul style="list-style-type: none"> <li>• If the connected device does not support <b>HDMI Compatibility Mode</b>, the screen or sound may not work properly.</li> <li>• When <b>HDMI Compatibility Mode</b> is on, HDR function is not supported.</li> </ul>	
OSD Lock	This feature disables the configuration and adjustment of menus.	
	On	Enables OSD Lock.
	Off	Disables OSD Lock.
	<p><b>NOTE</b></p> <ul style="list-style-type: none"> <li>• All features are disabled except Brightness, Contrast, Volume, Input, OSD Lock, Information.</li> </ul>	
Information	The display information will be shown the Serial Number, Total Power On Time, Resolution.	

Settings > General	Description		
Reset to Initial Settings	Do you want to reset your settings?	Yes	Returns to the default settings.
		No	Cancel the reset.

**!** NOTE

- Saving Data depends on the Panel. These values vary by panel and vendor. If the option **SMART ENERGY SAVING** is set **High** or **Low**, then monitor luminance becomes lower or higher depending upon the source.

# TROUBLESHOOTING

<b>Nothing is displayed on the screen.</b>	
Is the monitor's power cord plugged in?	<ul style="list-style-type: none"> <li>• Check if the power cord is correctly plugged into the power outlet.</li> <li>• Test the Power Plug using a lamp or other device.</li> </ul>
Is the power LED on?	<ul style="list-style-type: none"> <li>• Check the power cable connection and press the power button.</li> </ul>
Is the power on and the power LED displaying white?	<ul style="list-style-type: none"> <li>• Check that the connected input is enabled (<b>Settings &gt; Input &gt; Input list</b>).</li> </ul>
Is the power LED blinking?	<ul style="list-style-type: none"> <li>• If the monitor is in sleep mode, move the mouse, or press any key on the keyboard, to switch the display on.</li> <li>• Check if the computer is turned on.</li> </ul>
Is the <b>Out of Range</b> message being displayed?	<ul style="list-style-type: none"> <li>• This occurs when signals transferred from the PC (graphics card) are out of the horizontal or vertical frequency range of the monitor. Please see the Product Specification section of this manual to set the appropriate frequency.</li> </ul>
Is the <b>No Signal</b> message being displayed?	<ul style="list-style-type: none"> <li>• This is displayed when the signal cable between the PC and the monitor is missing or disconnected. Check the cable and reconnect it.</li> </ul>
<b>The OSD lock message is being displayed.</b>	
Are some functions not available when you press the Menu button?	<ul style="list-style-type: none"> <li>• The OSD is locked. Go to Settings &gt; General and set OSD Lock to Off.</li> </ul>
<b>The screen retains an image.</b>	
Does image sticking occur even when the monitor is turned off?	<ul style="list-style-type: none"> <li>• Displaying a still image for a prolonged time may cause damage to the screen, resulting in the retention of the image.</li> <li>• To extend the lifetime of the monitor, use a screensaver.</li> </ul>
<b>Screen display is unstable and shaky / Images displayed on the monitor leave shadow trails.</b>	
Did you select the appropriate resolution?	<ul style="list-style-type: none"> <li>• If the selected resolution is HDMI 1080i 60/50 Hz (interlaced), the screen may be flickering. Change the resolution to 1080P or the recommended resolution.</li> </ul>

**! NOTE**

- **Vertical frequency** In order to display an image, the screen must be refreshed dozens of times per second, like a fluorescent lamp. The number of times the screen is refreshed per second is called vertical frequency, or refresh rate, and is represented by Hz.
- **Horizontal frequency** The time it takes to display one horizontal line is called the horizontal cycle. If 1 is divided by the horizontal interval, the result is the number of horizontal lines displayed per second. This is called horizontal frequency and is represented by kHz.
- LED can be lighted with Set OSD Menu.  
Settings – General – Power LED – On

**! NOTE**

- Check if the graphics card's resolution or frequency is within the range allowed by the monitor and set it to the recommended (optimal) resolution in **Control Panel > Display > settings**.
- Not setting the graphics card to the recommended (optimal) resolution may result in blurred text, a dimmed screen, a truncated display area, or misalignment of the display.
- The setting methods may be different depending on the computer or operating system, and some resolutions may not be available depending on the performance of the graphics card. If this is the case, contact the manufacturer of the computer or graphics card for assistance.
- Some graphics cards may not support 2560 × 1080 resolution. If the resolution cannot be displayed, contact the manufacturer of your graphics card.

<b>The display color is abnormal.</b>	
Does the display appear discolored (16 colors)?	<ul style="list-style-type: none"> <li>• Set the color to 24 bit (true color) or higher. In Windows, go to Control Panel &gt; Display &gt; Settings &gt; Color Quality.</li> </ul>
Does the display color appear unstable or monochrome?	<ul style="list-style-type: none"> <li>• Check if the signal cable is connected properly. Reconnect the cable or reinsert the PC's graphics card.</li> </ul>
Are there spots on the screen?	<ul style="list-style-type: none"> <li>• When using the monitor, pixilated spots (red, green, blue, white, or black) may appear on the screen. This is normal for an LCD screen. It is not an error, nor is it related to the monitor's performance.</li> </ul>
<b>Do you see an "Unrecognized monitor, Plug&amp;Play (VESA DDC) monitor found" message?</b>	
Have you installed the display driver?	<ul style="list-style-type: none"> <li>• Be sure to install the display driver from our web site: <a href="http://www.lg.com">http://www.lg.com</a>.</li> <li>• Make sure to check if the video card supports Plug&amp;Play function.</li> </ul>
<b>No sound from the headphone port or speaker.</b>	
Are images displayed using DisplayPort or HDMI input without sound?	<ul style="list-style-type: none"> <li>• Try increasing the volume using the button on the monitor.</li> <li>• Set the audio output of the PC to the monitor you are using. On Microsoft Windows, go to Control Panel &gt; Hardware and Sound &gt; Sound &gt; set the monitor as default device.</li> </ul>

# PRODUCT SPECIFICATION

29WL500

<b>Color Depth</b>	8-bit / 10-bit color is supported.	
<b>Resolution</b>	Max Resolution	2560 x 1080 @ 75 Hz
	Recommended Resolution	2560 x 1080 @ 60 Hz
<b>Power Sources</b>	Power Rating	19 V --- 1.3 A
	Power Consumption (Typical)	On mode: 24.5 W Typ. (Outgoing condition)* Sleep Mode (Standby Mode) ≤ 0.5 W** Off Mode ≤ 0.3 W
<b>AC/DC Adapter</b>	<p>Type ADS-40SG-19-3 19025G, SHENZHEN HONOR ELECTRONIC production            Or type ADS-40FSG-19 19025GPG-1, SHENZHEN HONOR ELECTRONIC production            Or type ADS-40FSG-19 19025GPBR-1, SHENZHEN HONOR ELECTRONIC production            Or type ADS-40FSG-19 19025GPI-1, SHENZHEN HONOR ELECTRONIC production            Or type ADS-40FSG-19 19025GPCU-1, SHENZHEN HONOR ELECTRONIC production            Or type ADS-40FSG-19 19025GPB-2, SHENZHEN HONOR ELECTRONIC production            Or type ADS-25SFA-19-3 19025E, SHENZHEN HONOR ELECTRONIC production            Or type ADS-25FSF-19 19025EPCU-1, SHENZHEN HONOR ELECTRONIC production            Or type ADS-25FSF-19 19025EPBR-1, SHENZHEN HONOR ELECTRONIC production            Or type ADS-25FSF-19 19025EPI-1, SHENZHEN HONOR ELECTRONIC production            Or type ADS-25FSF-19 19025EPG-1, SHENZHEN HONOR ELECTRONIC production            Or type ADS-25FSF-19 19025EPB-1, SHENZHEN HONOR ELECTRONIC production            Or type LCAP21, LIEN CHANG ELECTRONIC ENTERPRISE production            Or type LCAP26-A, LIEN CHANG ELECTRONIC ENTERPRISE production            Or type LCAP26-E, LIEN CHANG ELECTRONIC ENTERPRISE production            Or type LCAP26-I, LIEN CHANG ELECTRONIC ENTERPRISE production            Or type LCAP26-B, LIEN CHANG ELECTRONIC ENTERPRISE production</p>	

	Or type WA-24C19FS, Asian Power Devices Inc. production Or type WA-24C19FN, Asian Power Devices Inc. production Or type DA-24B19, Asian Power Devices Inc. production Or type AD10560LF, PI Electronics (H.K.) Ltd. production Or type AD2139S20, PI Electronics (H.K.) Ltd. production Or type AD2139G20, PI Electronics (H.K.) Ltd. production Output: 19V $\overline{\sim}$ 1.3 A		
<b>Environmental Conditions</b>	Operating Conditions	Temperature	0 °C to 40 °C
		Humidity	Less than 80 %
	Storing Conditions	Temperature	-20 °C to 60 °C
		Humidity	Less than 85 %
<b>Dimensions</b>	Monitor Size (Width x Height x Depth)		
	With Stand (mm)	698.1 x 410.9 x 209.4	
	Without Stand (mm)	698.1 x 317.5 x 76.9	
<b>Weight (Without Packaging)</b>	With Stand (kg)	5.2	
	Without Stand (kg)	4.7	

The specifications are subject to change without notice.

The ~ symbol means alternating current, and the  $\overline{\sim}$  symbol means direct current.

The power consumption level can be different by operating condition and monitor setting.

\* The On mode power consumption is measured with LGE test standard (Full White pattern, Maximum resolution).

\*\* The monitor goes to the Sleep Mode in a couple of minutes (Max 5 minutes).

# PRODUCT SPECIFICATION

34WL500

<b>Color Depth</b>	8-bit / 10-bit color is supported.	
<b>Resolution</b>	Max Resolution	2560 x 1080 @ 75 Hz
	Recommended Resolution	2560 x 1080 @ 60 Hz
<b>Power Sources</b>	Power Rating	19 V --- 2.0 A
	Power Consumption (Typical)	On mode: 38 W Typ. (Outgoing condition)* Sleep Mode (Standby Mode) ≤ 0.5 W** Off Mode ≤ 0.3 W
<b>AC/DC Adapter</b>	Type ADS-45SN-19-3 19040G, SHENZHEN HONOR ELECTRONIC production Or type ADS-45SQ-19-3 19040E, SHENZHEN HONOR ELECTRONIC production Or type ADS-45FSQ-19 19040EPG-1, SHENZHEN HONOR ELECTRONIC production Or type ADS-45FSQ-19 19040EPK-1, SHENZHEN HONOR ELECTRONIC production Or type ADS-45FSQ-19 19040EPCU-1, SHENZHEN HONOR ELECTRONIC production Or type ADS-45FSQ-19 19040EPBR-1, SHENZHEN HONOR ELECTRONIC production Or type LCAP21C, LIEN CHANG ELECTRONIC ENTERPRISE production Or type LCAP26B-E, LIEN CHANG ELECTRONIC ENTERPRISE production Or type LCAP26B-A, LIEN CHANG ELECTRONIC ENTERPRISE production Or type AD10530LF, PI Electronics (H.K.) Ltd. production Or type AD2137S20, PI Electronics (H.K.) Ltd. production Or type AD2137620, PI Electronics (H.K.) Ltd. production Output: 19 V --- 2.1 A	
	Type DA-48F19, Asian Power Devices Inc. production (Only for India) Or type MS-Z2530R190-048M0-E, MOSO POWER SUPPLY TECHNOLOGY CO LTD production (Only for India) Output: 19 V --- 2.53 A	

<b>Environmental Conditions</b>	Operating Conditions	Temperature	0 °C to 40 °C
		Humidity	Less than 80 %
	Storing Conditions	Temperature	-20 °C to 60 °C
		Humidity	Less than 85 %
<b>Dimensions</b>	Monitor Size (Width x Height x Depth)		
	With Stand (mm)	825.6 x 487.4 x 208.8	
	Without Stand (mm)	825.6 x 369.8 x 51.2	
<b>Weight (Without Packaging)</b>	With Stand (kg)	6.9	
	Without Stand (kg)	5.9	

The specifications are subject to change without notice.

The ~ symbol means alternating current, and the --- symbol means direct current.

The power consumption level can be different by operating condition and monitor setting.

\* The On mode power consumption is measured with IEC test standard (Full White pattern , Maximum resolution).

\*\* The monitor goes to the Sleep Mode in a couple of minutes(Max 5 minutes).

## Factory Support Mode (Preset Mode, PC)

### HDMI

Preset Mode	Horizontal Frequency (kHz)	Vertical Frequency (Hz)	Polarity (H/V)	Remarks
640 x 480	31.469	59.94	-/-	
640 x 480	37.5	75	-/-	
800 x 600	37.879	60.317	+/+	
800 x 600	46.875	75.0	+/+	
1024 x 768	48.363	60	-/-	
1024 x 768	60.123	75.029	+/+	
1152 x 864	53.697	60	-/+	
1280 x 720	45.00	60.00	+/+	
1280 x 1024	63.981	60.02	+/+	
1280 x 1024	79.976	75.025	+/+	
1600 x 900	60.00	60.00	+/+	
1680 x 1050	65.29	59.954	-/+	
1920 x 1080	67.5	60	+/-	
2560 x 1080	66.636	59.98	-/+	
2560 x 1080	83.915	74.99	-/+	

## HDMI Timing (Video)

Preset Mode	Horizontal Frequency (kHz)	Vertical Frequency (Hz)	Remarks
480P	31.5	60	
576P	31.25	50	
720P	37.5	50	
720P	45	60	
1080P	56.25	50	
1080P	67.5	60	
2160P	67.5	30	

## Power LED

Mode	LED Color
On Mode	White (For a few seconds)
Sleep Mode (Standby Mode)	Off
Off Mode	Off



The model and serial number of the product are located on the back and on one side of the product.

Record them below in case you ever need service.

Model \_\_\_\_\_

Serial No. \_\_\_\_\_