



## INSTALLATION MANUAL

# AIR CONDITIONER

Please read this installation manual completely before installing the product.  
Installation work must be performed in accordance with the national wiring standards by authorized personnel only.

Please retain this installation manual for future reference after reading it thoroughly.

Ceiling Concealed Duct

Original instruction

[Manufacturer] LG Electronics Inc. Changwon 2nd factory 84, Wanam-ro, Seongsan-gu,  
Changwon-si, Gyeongsangnam-do, KOREA



MFL67939918  
Rev.02\_022525

Copyright © 2015 - 2025 LG Electronics Inc. All Rights Reserved.

[www.lg.com](http://www.lg.com)

ENGLISH

ITALIANO

ESPAÑOL

FRANÇAIS

DEUTSCH

EMHNIKA

ČEŠTINA

NERLANDS

POLSKI

LIMBA ROMÂNĂ

# TABLE OF CONTENTS

## 3 SAFETY PRECAUTIONS

---

## 8 MODEL DESIGNATION

---

- 8 Product information
- 9 Airborne Noise Emission
- 9 Limiting concentration

## 10 EXTERNAL APPEARANCE

---

## 11 INSTALLATION PLACES

---

- 11 Selection of the best location

## 13 THE INDOOR UNIT INSTALLATION

---

- 19 Indoor Unit Drain Piping
- 19 Drain test
- 21 Heat Insulation
- 22 Wiring Connection

## 24 REMOTE CONTROLLER INSTALLATION

---

- 25 Wired remote controller installation
- 26 Wired Remote Controller

## 27 OPTIONAL OPERATION

---

- 27 Installer Setting -Test Run Mode
- 28 Installer Setting - Setting Address of Central Control
- 29 Installer Setting -Thermistor
- 30 Installer Setting-Group Setting
- 31 Installer Setting-Dry Contact Mode Setting
- 32 Installer Setting-Celsius / Fahrenheit Switching
- 33 Installer Setting -Optional Function Setting
- 34 Installer Setting – Remote controller Mode Lock

## 35 HOW TO SET E.S.P?

---

- 35 Installer Setting -E.S.P.
- 36 Installer Setting - Static Pressure Step Setting

## 42 SELF-DIAGNOSIS FUNCTION

---

## 42 DIP SWITCH SETTING

---

# Safety Precautions



To prevent the injury of the user or other people and property damage, the following instructions must be followed.

- Be sure to read before installing the air conditioner.
- Be sure to observe the cautions specified here as they include important items related to safety.
- Incorrect operation due to ignoring instruction will cause harm or damage. The seriousness is classified by the following indications.

**⚠ WARNING** This symbol indicates the possibility of death or serious injury.

**⚠ CAUTION** This symbol indicates the possibility of injury or damage to properties only.

- The meanings of the symbols used in this manual are as shown below.

	<b>Be sure not to do.</b>
	<b>Be sure to follow the instruction.</b>

**⚠ WARNING**

## Installation

- Do not use a defective or underrated circuit breaker. Use this appliance on a dedicated circuit.
  - There is risk of fire or electric shock.
- For electrical work, contact the dealer, seller, a qualified electrician, or an Authorized Service Center.
  - Do not disassemble or repair the product. There is risk of fire or electric shock.
- Always ground the product.
  - There is risk of fire or electric shock.
- Install the panel and the cover of control box securely.
  - There is risk of fire or electric shock.
- Always install a dedicated circuit and breaker.
  - Improper wiring or installation may cause fire or electric shock.
- Use the correctly rated breaker or fuse.
  - There is risk of fire or electric shock.
- Do not modify or extend the power cable.
  - There is risk of fire or electric shock.

- Do not install, remove, or re-install the unit by yourself (customer).
  - There is risk of fire, electric shock, explosion, or injury.
- Be cautious when unpacking and installing the product.
  - Sharp edges could cause injury. Be especially careful of the case edges and the fins on the condenser and evaporator.
- For installation, always contact the dealer or an Authorized Service Center.
  - There is risk of fire, electric shock, explosion, or injury.
- Do not install the product on a defective installation stand.
  - It may cause injury, accident, or damage to the product.
- Be sure the installation area does not deteriorate with age.
  - If the base collapses, the air conditioner could fall with it, causing property damage, product failure, and personal injury.
- Do not turn on the breaker or power under condition that front panel, cabinet, top cover, control box cover are removed or opened.
  - Otherwise, it may cause fire, electric shock, explosion or death.
- Use a vacuum pump or Inert (nitrogen) gas when doing leakage test or air purge. Do not compress air or Oxygen and Do not use Flammable gases. Otherwise, it may cause fire or explosion.
  - There is the risk of death, injury, fire or explosion.

## **Operation**

- Do not let the air conditioner run for a long time when the humidity is very high and a door or a window is left open.
  - Moisture may condense and wet or damage furniture.
- Take care to ensure that power cable could not be pulled out or damaged during operation.
  - There is risk of fire or electric shock.
- Do not place anything on the power cable.
  - There is risk of fire or electric shock.
- Do not touch(operate) the product with wet hands.
  - There is risk of fire or electrical shock.
- Do not place a heater or other appliances near the power cable.
  - There is risk of fire and electric shock.
- Do not allow water to run into electric parts.
  - It may cause There is risk of fire, failure of the product, or electric shock.

- Do not store or use flammable gas or combustibles near the product.
  - There is risk of fire or failure of product.
- Do not use the product in a tightly closed space for a long time.
  - Oxygen deficiency could occur.
- When flammable gas leaks, turn off the gas and open a window for ventilation before turn the product on.
  - Do not use the telephone or turn switches on or off. There is risk of explosion or fire.
- If strange sounds, or smell or smoke comes from product. Turn the breaker off or disconnect the power supply cable.
  - There is risk of electric shock or fire.
- Stop operation and close the window in storm or hurricane. If possible, remove the product from the window before the hurricane arrives.
  - There is risk of property damage, failure of product, or electric shock.
- Do not open the inlet grill of the product during operation. (Do not touch the electrostatic filter, if the unit is so equipped.)
  - There is risk of physical injury, electric shock, or product failure.
- When the product is soaked (flooded or submerged), contact an Authorized Service Center.
  - There is risk of fire or electric shock.
- Be cautious that water could not enter the product.
  - There is risk of fire, electric shock, or product damage.
- Ventilate the product from time to time when operating it together with a stove, etc.
  - There is risk of fire or electric shock.
- Turn the main power off when cleaning or maintaining the product.
  - There is risk of electric shock.
- When the product is not be used for a long time, disconnect the power supply plug or turn off the breaker.
  - There is risk of product damage or failure, or unintended operation.
- Take care to ensure that nobody could step on or fall onto the outdoor unit.
  - This could result in personal injury and product damage.

 **CAUTION**

---

## **Installation**

- Always check for gas (refrigerant) leakage after installation or repair of product.
  - Low refrigerant levels may cause failure of product.
- Install the drain hose to ensure that water is drained away properly.
  - A bad connection may cause water leakage.
- Keep level even when installing the product.
  - To avoid vibration or water leakage.
- Do not install the product where the noise or hot air from the outdoor unit could damage the neighborhoods.
  - It may cause a problem for your neighbors.
- Use two or more people to lift and transport the product.
  - Avoid personal injury.
- Do not install the product where it will be exposed to sea wind (salt spray) directly.
  - It may cause corrosion on the product. Corrosion, particularly on the condenser and evaporator fins, could cause product malfunction or inefficient operation.
- Do not install the unit in potentially explosive atmospheres.

## **Operation**

- Do not expose the skin directly to cool air for long periods of time. (Don't sit in the draft.)
  - This could harm to your health.
- Do not use the product for special purposes, such as preserving foods, works of art, etc. It is a consumer air conditioner, not a precision refrigeration system.
  - There is risk of damage or loss of property.
- Do not block the inlet or outlet of air flow.
  - It may cause product failure.
- Use a soft cloth to clean. Do not use harsh detergents, solvents, etc.
  - There is risk of fire, electric shock, or damage to the plastic parts of the product.

- Do not touch the metal parts of the product when removing the air filter. They are very sharp!
  - There is risk of personal injury.
- Do not step on or put anything on the product. (outdoor units)
  - There is risk of personal injury and failure of product.
- Always insert the filter securely. Clean the filter every two weeks or more often if necessary.
  - A dirty filter reduces the efficiency of the air conditioner and could cause product malfunction or damage.
- Do not insert hands or other objects through the air inlet or outlet while the product is operated.
  - There are sharp and moving parts that could cause personal injury.
- Do not drink the water drained from the product.
  - It is not sanitary and could cause serious health issues.
- Use a firm stool or ladder when cleaning or maintaining the product.
  - Be careful and avoid personal injury.
- Replace the all batteries in the remote control with new ones of the same type. Do not mix old and new batteries or different types of batteries.
  - There is risk of fire or explosion.
- Do not recharge or disassemble the batteries.  
Do not dispose of batteries in a fire.
  - They may burn or explode.
- If the liquid from the batteries gets onto your skin or clothes, wash it well with clean water. Do not use the remote if the batteries have leaked.
  - The chemicals in batteries could cause burns or other health hazards.
- If you eat the liquid from the batteries, brush your teeth and see doctor.  
Do not use the remote if the batteries have leaked.
  - The chemicals in batteries could cause burns or other health hazards.

# Model Designation

## Product information

- Product Name : Air conditioner
- Model Name :

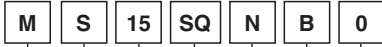

- Serial number
- Chassis name
- Indoor Unit / Outdoor Units  
N : Indoor Unit    U : Outdoor Unit
- Detailed product type for U- / C- series models  
L : Low Static    H : High COP    C : Econo  
ISL : Product for the Israel
- Nominal Capacity  
Ex) 7 000 Btu/h Class → '07', 18 000 Btu/h Class → '18'
- Product type  
S : Wall mounted / ARTCOOL mirror    J : Wall mounted  
A : ARTCOOL    T : Ceiling Cassette  
B, M : Ceiling Concealed Duct    V : Ceiling Suspended & floor  
Q : Console    P : Floor Standing
- Connectable Outdoor unit type  
U : Indoor units only for Single A systems  
C : Common Indoor Unit for Multi and Single CAC

- Additional Information : serial number is refer to the barcode on the product.
- Max allowable pressure High side :  
4.2 MPa / Low side : 2.4 MPa
- Refrigerant : R410A

## Airborne Noise Emission

The A-weighted sound pressure emitted by this product is below 70 dB.

\*\* The noise level can vary depending on the site.

The figures quoted are emission level and are not necessarily safe working levels.

Whilst there is a correlation between the emission and exposure levels, this cannot be used reliably to determine whether or not further precautions are required.

Factor that influence the actual level of exposure of the workforce include the characteristics of the work room and the other sources of noise, i.e. the number of equipment and other adjacent processes and the length of time for which an operator exposed to the noise. Also, the permissible exposure level can vary from country to country.

This information, however, will enable the user of the equipment to make a better evaluation of the hazard and risk.

## Limiting concentration

Limiting concentration is the limit of Freon gas concentration where immediate measures can be taken without hurting human body when refrigerant leaks in the air. The limiting concentration shall be described in the unit of  $\text{kg/m}^3$  (Freon gas weight per unit air volume) for facilitating calculation

<b>Limiting concentration: 0.44 <math>\text{kg/m}^3</math> (R410A)</b>
--

### ■ Calculate refrigerant concentration

$$\text{Refrigerant concentration (kg/m}^3\text{)} = \frac{\text{Total amount of replenished refrigerant in refrigerant facility (kg)}}{\text{Capacity of smallest room where indoor unit is installed (m}^3\text{)}}$$

# External Appearance

- **Ceiling Concealed Duct – Low static pressure**  
L1/L2/L3 Chassis



- **Ceiling Concealed Duct – Mid static pressure**  
M1/M2/M3 Chassis



- **Ceiling Concealed Duct – H-INV**  
BR Chassis



- **Ceiling Concealed Duct – High static pressure**  
B8 Chassis



- **Ceiling Concealed Duct – Compact**  
BH Chassis



# Installation Places

## Selection of the best location

Install the air conditioner in the location that satisfies the following conditions.

- The place shall easily bear a load exceeding four times the indoor unit's weight.
- The place shall be able to inspect the unit as the figure.
- The place where the unit shall be leveled.
- The place shall allow easy water drainage.  
(Suitable dimension "H" is necessary to get a slope to drain as figure.)
- The place shall easily connect with the outdoor unit.
- The place where the unit is not affected by an electrical noise.
- The place where air circulation in the room will be good .
- There should not be any heat source or steam near the unit.

### Ceiling Concealed Duct – Low Static

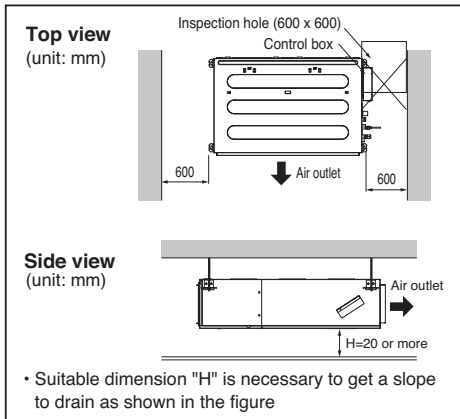

### Ceiling Concealed Duct – Mid Static

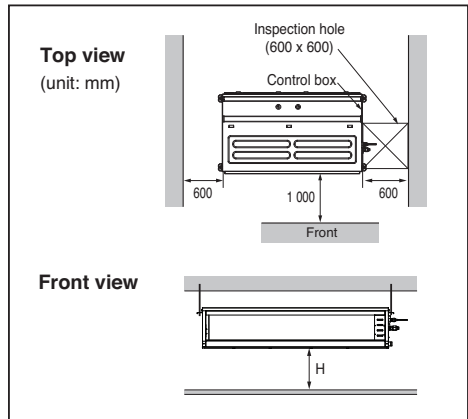

### Ceiling Concealed Duct – Compact

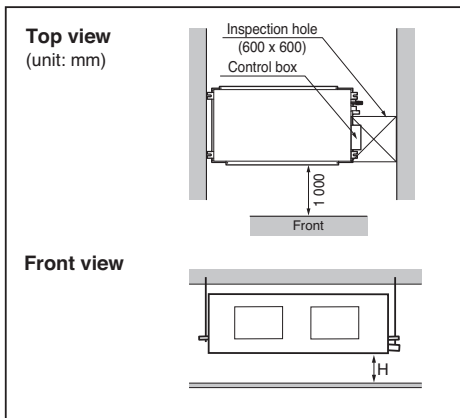

**Ceiling Concealed Duct – H-INV**

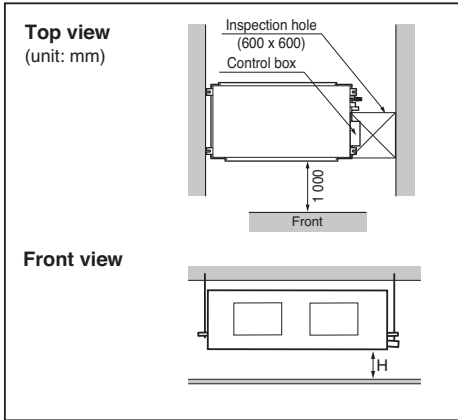

**Ceiling Concealed Duct – High Static**

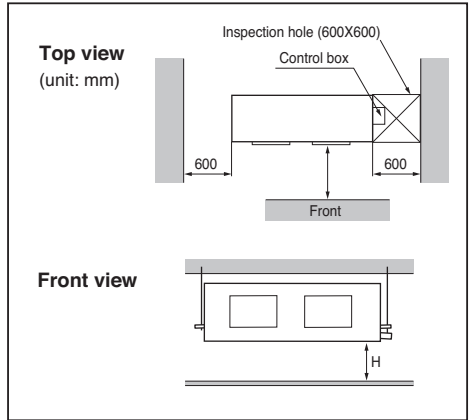

**⚠ CAUTION**

In case that the unit is installed near the sea, the installation parts may be corroded by salt, The installation parts (and the unit) should be taken appropriate anti corrosion measures.

**[Inspection Hole Standard]**

Number of Inspection hole	Distance between False ceiling & Actual ceiling	Remarks
1	More than 100 cm	Sufficient space in the ceiling for servicing.
2	20 cm to 100 cm	Insufficient space. Difficult for servicing
Hole size should be more than the size of IDU.	Less than 20 cm	Minimum height for motor replacement.

# The indoor unit installation

## Installation of Unit

Install the unit above the ceiling correctly.

### CASE 1

#### POSITION OF SUSPENSION BOLT

- Apply a joint-canvas between the unit and duct to absorb unnecessary vibration.
- Apply a filter Accessory at air return hole.

#### Ceiling Concealed Duct – Low Static

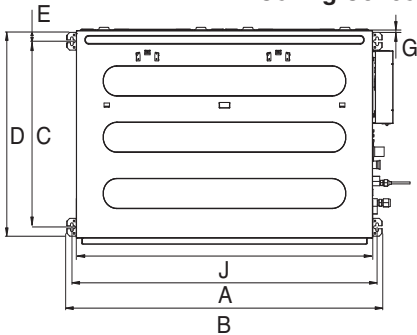

(Unit: mm)

Dimension \ Capacity (kBTU/h)	A	B	C	D	E	F	G	H	I	J
9	733	772	628	700	36	190	20	660	155	700
12/18	933	972	628	700	36	190	20	860	155	900
24	1133	1172	628	700	36	190	20	1060	155	1100

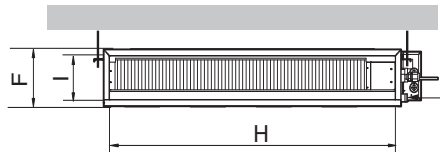

Drainage hole

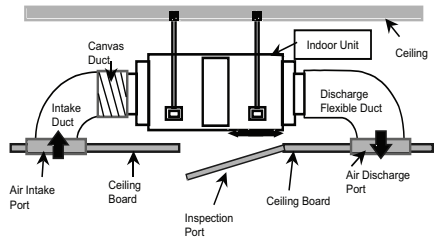

#### Ceiling Concealed Duct – Compact

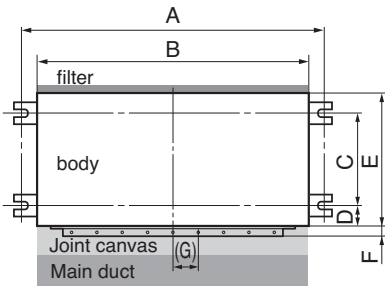

(Unit:mm)

Dimension \ Capacity	A	B	C	D	E	F	(G)	H	I	J
18/24 K	932	882	355	46	450	30	87	750	163	260

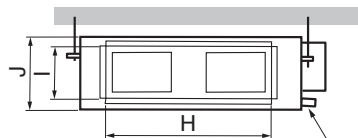

Drainage hole

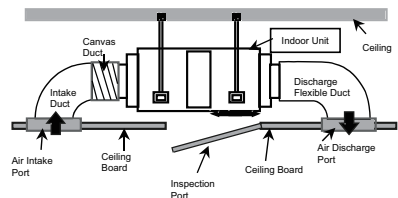

### Ceiling Concealed Duct – Mid Static

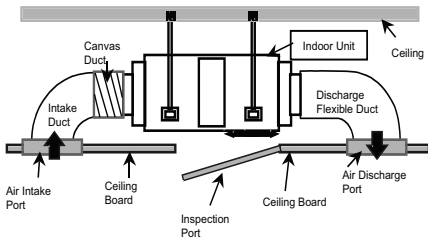
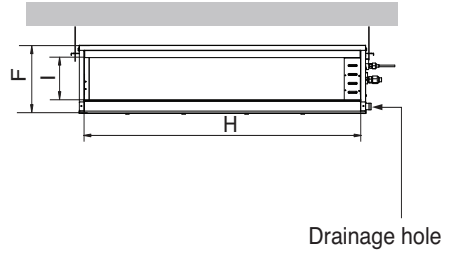
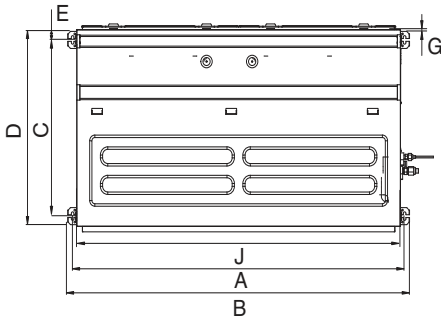

(Unit:mm)

Capacity (kBTu/h)	Dimension									
	A	B	C	D	E	F	G	H	I	J
18 / 24 / 30	933.4	971.6	619.2	700	30	270	15.2	858	201.4	900
36(10) / 42	1 283.4	1 321.6	619.2	689.6	30	270	15.2	1 208	201.4	1 250
36(30) / 48 / 60	1 283.4	1 321.6	619.2	689.6	30	360	15.2	1 208	291.4	1 250

### Ceiling Concealed Duct – H-INV

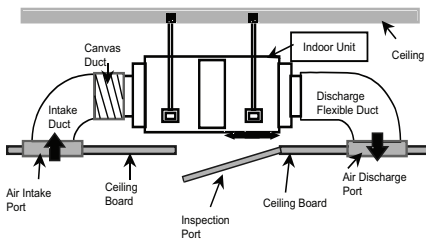
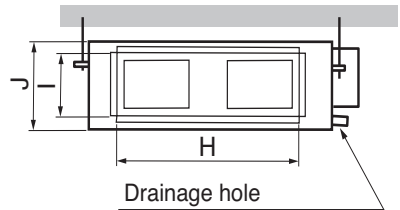
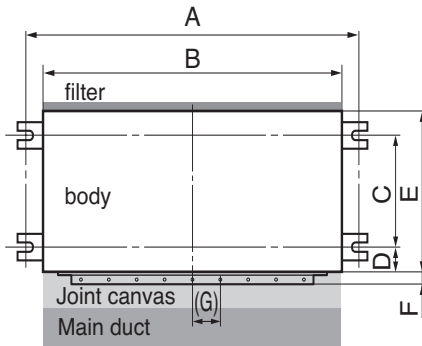

(Unit:mm)

Capacity (kBTu/h)	Dimension									
	A	B	C	D	E	F (G)	H	I	J	
36 / 42 / 46	1 290	1 230	447	56	590	30	120	1 006	294	380

### Ceiling Concealed Duct – High Static

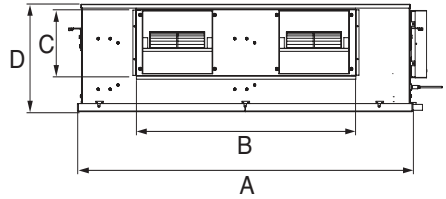
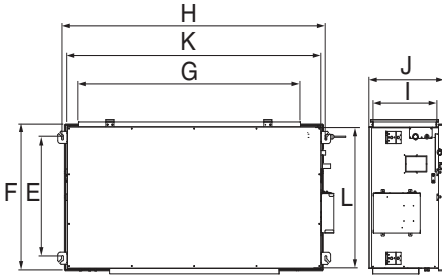

(Unit:mm)

Dimension	A	B	C	D	E	F	G	H	I	J	K	L
Capacity (kBTu/h)												
70	1 594	1 044	286	460	580	713	1 368	1 622	392	458	1 563	791
85												

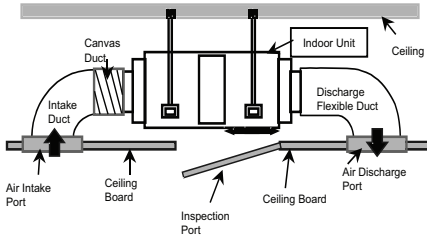

#### CASE 2

- Install the unit leaning to a drainage hole side as a figure for easy water drainage.

#### POSITION OF CONSOLE BOLT

- A place where the unit will be leveled and that can support the weight of the unit.
- A place where the unit can withstand its vibration.
- A place where service can be easily performed.

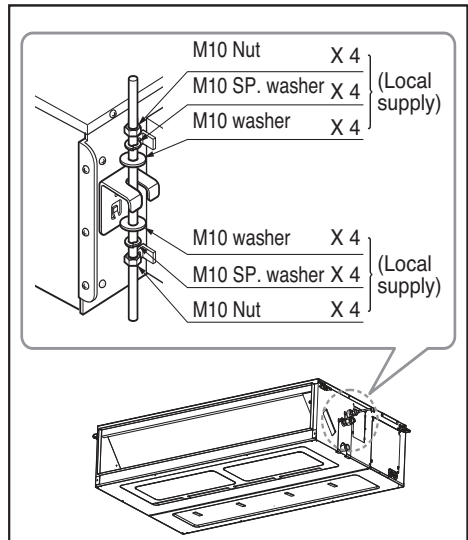

## Installation Places

- Select and mark the position for fixing bolts.
- Drill the hole for set anchor on the face of ceiling.

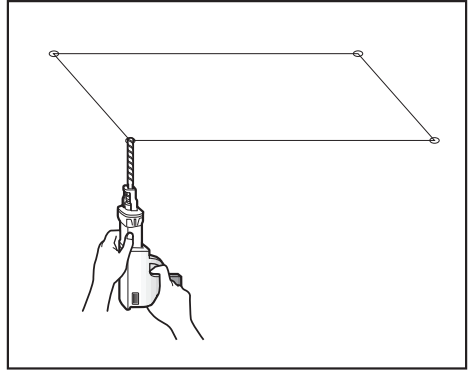

- Insert the set anchor and washer onto the suspension bolts for locking the suspension bolts on the ceiling.
- Mount the suspension bolts to the set anchor firmly.
- Secure the installation plates onto the suspension bolts (adjust level roughly) using nuts, washers and spring washers.

## **⚠ CAUTION**

Tighten the nut and bolt top revent unit falling.

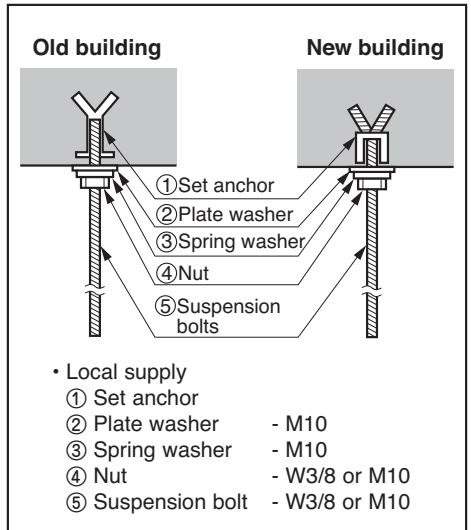

**CAUTION**

1. **Install declination** of the indoor unit is very **important for the drain** of the duct type air conditioner.
2. Minimum thickness of the insulation for the connecting pipe shall be 10mm.

**FRONT OF VIEW**

- The unit must be horizontal or declined to the drain hose connected when finished installation.

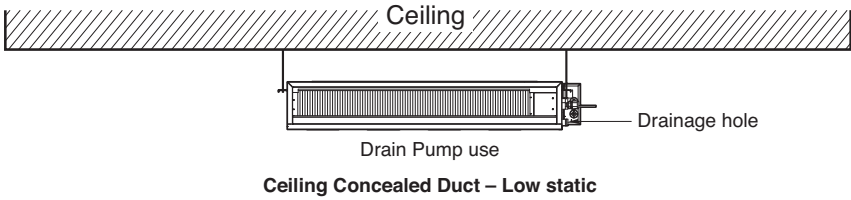

- The unit must be declined to the drain hose connected when finished installation.

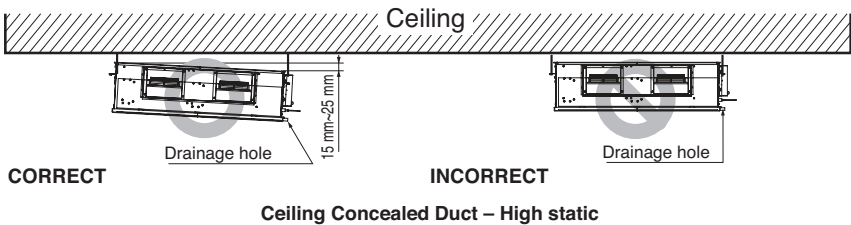
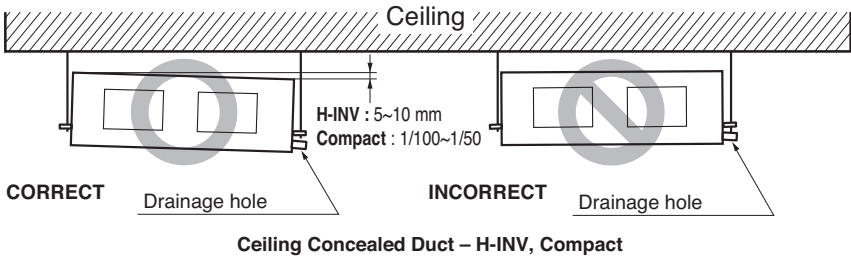
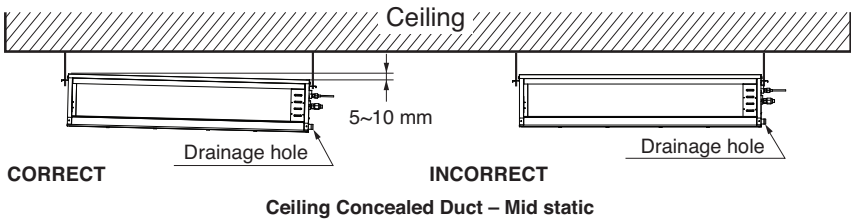

## CAUTION FOR GRADIENT OF UNIT AND DRAIN PIPING

Lay the drain hose with a downward inclination so water will drain out.

- Always lay the drain with downward inclination. Prevent any upward flow or reverse flow in any part.
- 10 mm or thicker formed thermal insulator shall always be provided for the drain pipe.

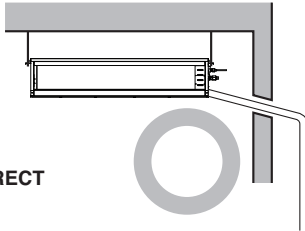
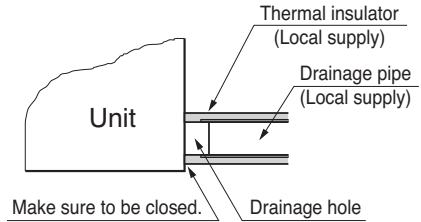

**CORRECT**

- Upward routing not allowed

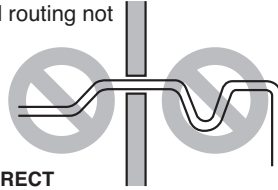

**INCORRECT**

### Applied U-Trap Dimension

$A \geq 70 \text{ mm}$

$B \geq 2C$

$C \geq 2 \times \text{SP}$

SP = External Pressure (mmAq)

Ex) External Pressure = 10 mmAq

$A \geq 70 \text{ mm}$

$B \geq 40 \text{ mm}$

$C \geq 20 \text{ mm}$

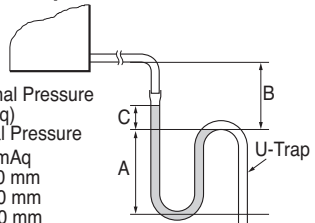

- Install the P-Trap (or U-Trap) to prevent a water leakage caused by the blocking of intake air filter.

## Indoor Unit Drain Piping

- Drain piping must have down-slope : be sure not to provide up-and-down slope to prevent reversal flow.
- During drain piping connection, be careful not to exert extra force on the drain port on the indoor unit.
- The outside diameter of the drain connection on the indoor unit is 32 mm.  
(Ceiling Concealed Duct – High static: 65 mm)

Piping material: Polyvinyl chloride pipe VP-25 and pipe fittings

- Be sure to execute heat insulation on the drain piping.
- Install the drain raising pipes at a right angle to the indoor unit and no more than 300 mm from the unit.

Heat insulation material: Polyethylene foam with thickness more than 10 mm.

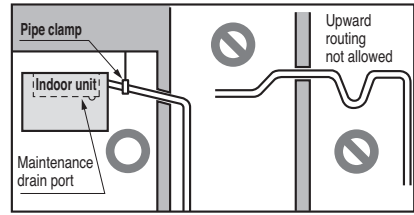

## Drain test

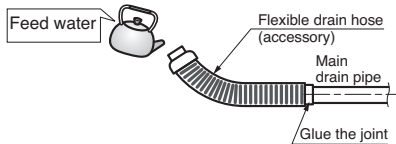

- Connect the main drain pipe to the exterior and leave it provisionally until the test comes to an end.
- Feed water to the flexible drain hose and check the piping for leakage.
- When the test is complete, connect the flexible drain hose to the drain port on the indoor unit.

## ⚠ CAUTION

The supplied flexible drain hose should not be curved, neither screwed. The curved or screwed hose may cause a leakage of water.

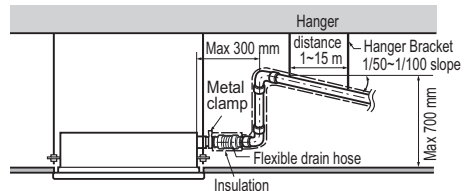

1) Remove the Air Filter.

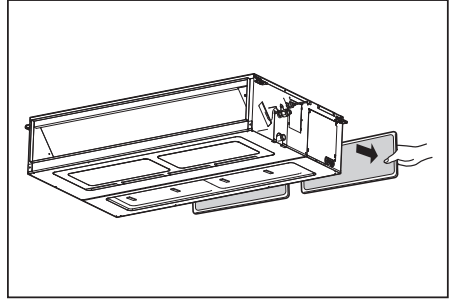

2) Check the drainage.

- Spray one or two glasses of water upon the evaporator.
- Ensure that water flows drain hose of indoor unit without any leakage.

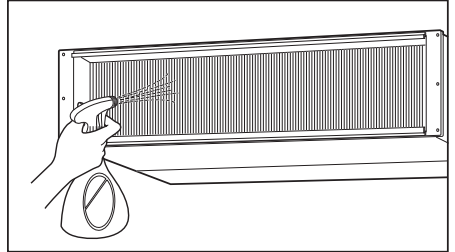

## Heat Insulation

Be sure to give insulation work to refrigerant piping by covering liquid pipe and gas pipe separately with enough thickness heat-resistant polyethylene, so that no gap is observed in the joint between indoor unit and insulating material, and insulating materials themselves. When insulation work is insufficient, there is a possibility of condensation drip, etc. Pay special attention to insulation work to ceiling plenum.

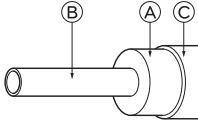

- Ⓐ Heat insulation material
- Ⓑ Pipe
- Ⓒ Outer covering(Wind the connection part and cutting part of heat insulation material with a finishing tape.)

Heat insulation material	Adhesive + Heat - resistant polyethylene foam + Adhesive tape	
Outer covering	Indoor	Vinyl tape
	Floor exposed	Water-proof hemp cloth + Bronze asphalt
	Outdoor	Water-proof hemp cloth + Zinc plate + Oily paint

### Note :

When using polyethylene cover as covering material, asphalt roofing shall not be required.

<p>Bad example</p>	<p>• Do not insulate gas or low pressure pipe and liquid or high pressure pipe together.</p> <ul style="list-style-type: none"> <li>Ⓐ Liquid pipe</li> <li>Ⓑ Gas pipe</li> <li>Ⓒ Power cables</li> <li>Ⓓ Finishing tape</li> <li>Ⓔ Insulating material</li> <li>Ⓕ Communication cables</li> </ul>	<p>• Be sure to fully insulate connecting portion.</p> <p>Ⓐ These parts are not insulated.</p>
<p>Good example</p>	<ul style="list-style-type: none"> <li>Ⓐ Liquid pipe</li> <li>Ⓑ Gas pipe</li> <li>Ⓒ Power cables</li> <li>Ⓓ Insulating material</li> <li>Ⓔ Communication cables</li> </ul>	

## ⚠ CAUTION

Cutting line of insulation must look upper direction. Thickness of insulation is 15 mm(Gas pipe) and 19 mm(Liquid pipe) or over.

### Note :

Recommended Insulation material

Material : EPDM

Thickness : 15 mm(Gas pipe) and 19 mm(Liquid pipe) or over.

Density : less than  $0.032 \pm 0.005(\text{g}/\text{cm}^3)$

Thermal conductivity : less than  $0.03(\text{kcal}/\text{m}\cdot\text{hr}\cdot^\circ\text{C})$

## Wiring Connection

- Open the control box cover and connect the Remote controller cord and Indoor power wires.
- Remove the control box cover for electrical connection between the indoor and outdoor unit. (Remove screws ①.)
- Use the cord clumper to fix the cord.

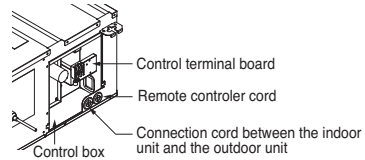
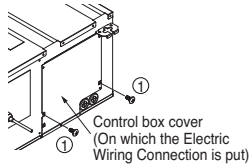

### Ceiling Concealed Duct – Low Static, Mid Static

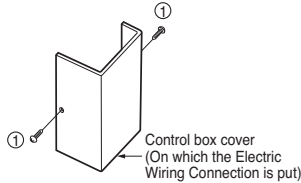
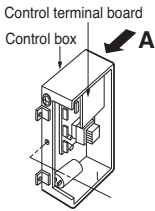

#### A view

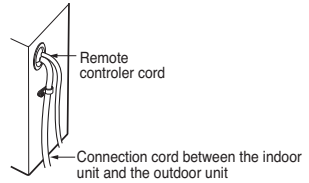

### Ceiling Concealed Duct – H-INV, Compact

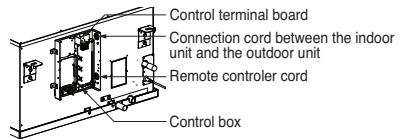
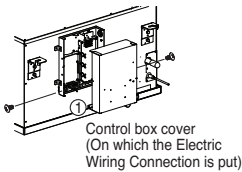

### Ceiling Concealed Duct – High static

## ⚠ CAUTION

The connecting cable connected to the indoor and outdoor unit should be complied with the following specifications (Rubber insulation, type H05RN-F approved by HAR or SAA).

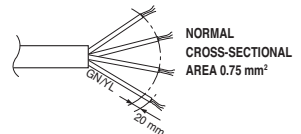

If the supply cord is damaged, it must be replaced by a special cord or assembly available from the manufacturer of its service agent. When the connection line between the indoor unit and outdoor unit and outdoor unit is over 40 m, connect the telecommunication line and power line separately.

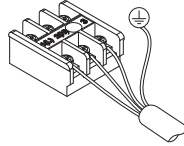

### ◆ Precautions when laying power wiring

Use round pressure terminals for connections to the power terminal block.

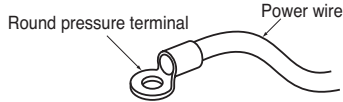

When none are available, follow the instructions below.

- Do not connect wiring of different thicknesses to the power terminal block. (Slack in the power wiring may cause abnormal heat.)
- When connecting wiring which is the same thickness, do as shown in the figure below.

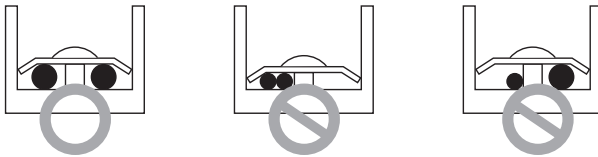

- For wiring, use the designated power wire and connect firmly, then secure to prevent outside pressure being exerted on the terminal block.
- Use an appropriate screwdriver for tightening the terminal screws. A screwdriver with a small head will strip the head and make proper tightening impossible.
- Over-tightening the terminal screws may break them.
- Pipes and wires should be purchased separately for installation of the product.

## HAND OVER

Teach the customer the operation and maintenance procedures, using the operation manual. (air filter cleaning, temperature control, etc.)

# Remote Controller Installation

**1. Please fix tightly using provided screw after placing remote controller setup board on the place where you like to setup.**

- Please set it up not to bend because poor setup could take place if setup board bends.  
Please set up remote controller board fit to the reclamation box if there is a reclamation box.
- Install the product so as not to make a gap with the wall side and to prevent shaking after the installation.

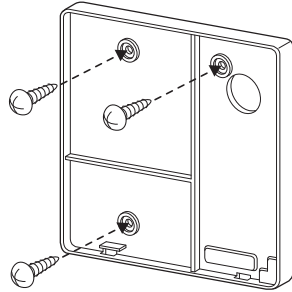

**2. Can set up Wired remote controller cable into three directions.**

- Setup direction: the surface of wall reclamation, upper, right
- If setting up remote controller cable into upper and right side, please set up after removing remote controller cable guide groove.

\* Remove guide groove with long nose.

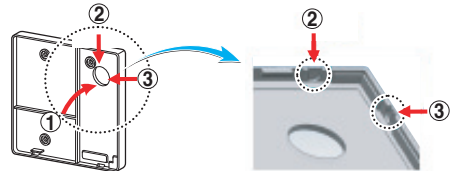

<Wire guide grooves>

- ① Reclamation to the surface of the wall
- ② Upper part guide groove
- ③ Right part guide groove

**3. Please fix remote controller upper part into the setup board attached to the surface of the wall, as the picture below, and then, connect with setup board by pressing lower part.**

- Please connect not to make a gap at the remote controller and setup board's upper and lower, right and left part.
- Before assembly with the installation board, arrange the Cable not to interfere with circuit parts.

<Connecting order>

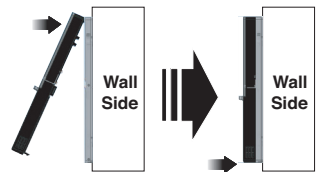

**When separating remote controller from setup board, as the picture below, after inserting into the lower separating hole using screw driver and then, spinning clockwise, remote controller is separated.**

- There are two separating holes. Please individually separate one at a time.
- Please be careful not to damage the inside components when separating.

<Separating order>

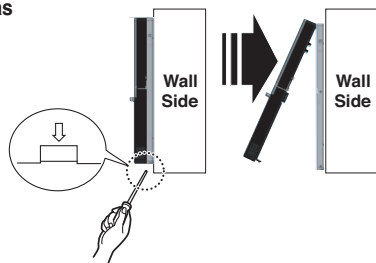

#### 4. Please connect indoor unit and remote controller using connection cable.

12 V	Red
Signal	Yellow
GND	Black

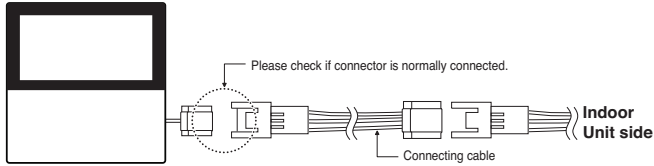

#### 5. Please use extension cable if the distance between wired remote controller and indoor unit is more than 10 m.

### CAUTION

When installing the wired remote controller, do not bury it in the wall. (It can cause damage in the temperature sensor.)

Do not install the cable to be 50m or above. (It can cause communication error.)

- When installing the extension cable, check the connecting direction of the connector of the remote controller side and the product side for correct installation.
- If you install the extension cable in the opposite direction, the connector will not be connected.
- Specification of extension cable: 2547 1007 22# 2 core 3 shield 5 or above.

### Wired remote controller installation

- Since the room temperature sensor is in the remote controller, the remote controller box should be installed in a place away from direct sunlight, high humidity and direct supply of cold air to maintain proper space temperature. Install the remote controller about 5 ft(1.5 m) above the floor in an area with good air circulation at an average temperature.

**Do not install the remote controller where it can be affected by:**

- Drafts, or dead spots behind doors and in corners.
- Hot or cold air from ducts.
- Radiant heat from sun or appliances.
- Concealed pipes and chimneys.
- Uncontrolled areas such as an outside wall behind the remote controller.
- This remote controller is equipped with a seven segment LED. display. For proper display of the remote controller LED's, the remote controller should be installed properly as shown in Fig.1. (The standard height is 1.2~1.5 m from floor level.)

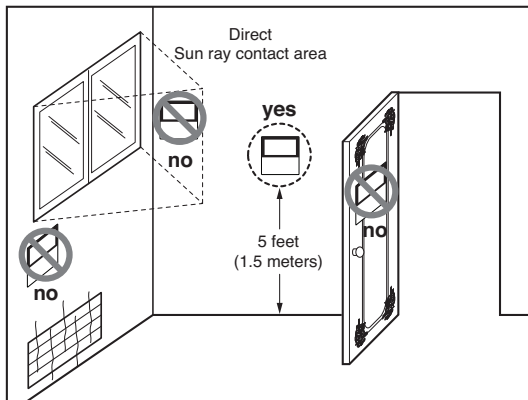
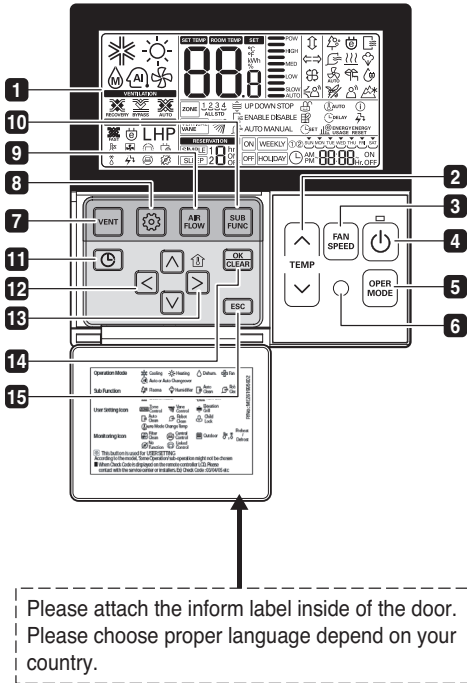

Fig.1 Typical locations for remote controller

## Wired Remote Controller



- 1** OPERATION INDICATION SCREEN
- 2** SET TEMPERATURE BUTTON
- 3** FAN SPEED BUTTON
- 4** ON/OFF BUTTON
- 5** OPERATION MODE SELECTION BUTTON
- 6** WIRELESS REMOTE CONTROLLER RECEIVER
  - Some products don't receive the wireless signals.
- 7** VENTILATION BUTTON
- 8** FUNCTION SETTING BUTTON
- 9** AIR FLOW BUTTON
- 10** SUBFUNCTION BUTTON
- 11** RESERVATION
- 12** UP,DOWN,LEFT,RIGHT BUTTON
  - To check the indoor temperature, press  button.
- 13** ROOM TEMPERATURE BUTTON
- 14** SETTING/CANCEL BUTTON
- 15** EXIT BUTTON

\* Some functions may not be operated and displayed depending on the product type.

### NOTE

- \* Display temperature can be different from actual room temperature if the remote controller is installed at the place where sun-rays are falling directly or the place nearby heat source.
- \* The actual product can be different from above contents depending upon model type.
- \* When using simultaneous operation system, whenever press remote controller button, system will approximately operate after 1~2 minutes.

# Optional Operation

## Installer Setting - Test Run Mode

After installing the product, you must run a Test Run mode.

For details related to this operation, refer to the product manual.

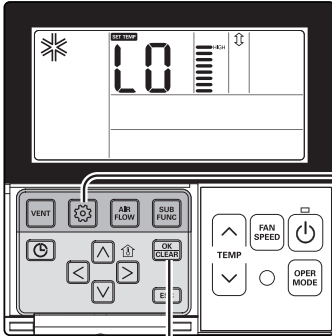

**1** If pressing  button long for 3 seconds, it enters into remote controller setter setup mode.

- If pressing once shortly, it enters into user setup mode. Please press more than 3 seconds for sure.
- Please cancel the right and left of wind direction for RAC product.



**2** Setup figure '01' blinks at the lower part of indication window.

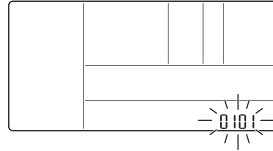

**3** Press  button to start.

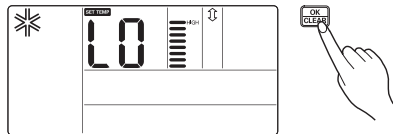



**4** During the test run, pressing the below button will exit the test run.

- Select operation, temperature up/down, wind flow control, wind direction, start/stop button.

## Installer Setting - Setting Address of Central Control

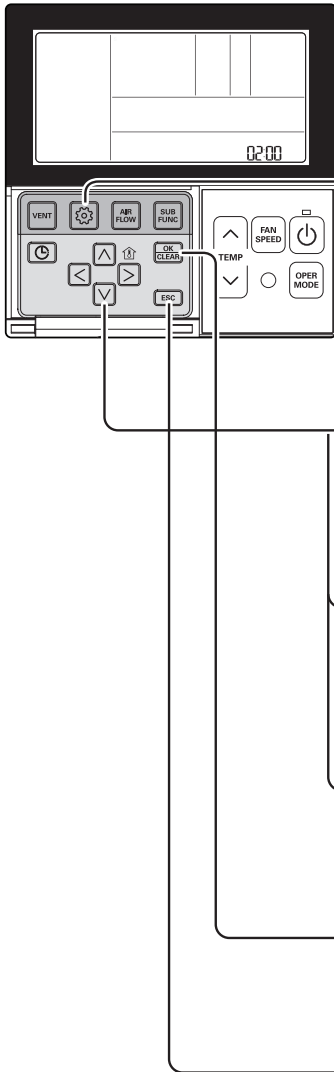
It's the function to use for connecting central control.  
Please refer to central controller manual for the details





**1** If pressing  button long for 3 seconds, it enters into remote controller setter setup mode.  
- If pressing once shortly, it enters into user setup mode. Please press more than 3 seconds for sure.



**2** If entering into address setup mode by using  button, it indicates as picture below.



**3** Set Group No. by pressing   button.(0~F)

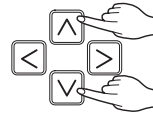

02:F0

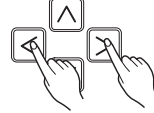

**4** Move to Indoor No. setting option by pressing   button.

02:F0



**5** Set Indoor No. by pressing   button.

02:F5

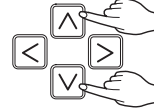

**6** Press  button to save.

02:F5





**7** Pressing  button will exit settings mode.  
\* After setup, it automatically gets out of setup mode if there is no button input for 25 seconds.  
\* When exiting without pressing set button, the manipulated value is not reflected.

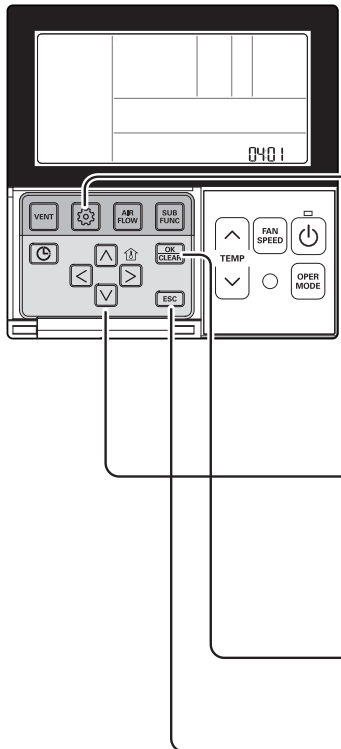

## Installer Setting - Thermistor

This is the function to select the temperature sensor to judge the room temperature.





- If pressing  button long for 3 seconds, it enters into remote controller setter setup mode.  
- If pressing once shortly, it enters into user setup mode. Please press more than 3 seconds for sure.

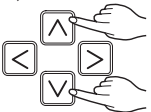

- If moving to room temperature perception sensor selection menu by pressing  button, it indicates as picture below.

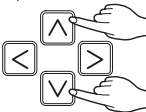

- Set Thermistor value by pressing   button. (01: Remote Controller, 02: Indoor, 03: 2TH)



Function Code      Thermistor setting

- Press  button to save.



- Pressing  button will exit settings mode.  
\* After setup, it automatically gets out of setup mode if there is no button input for 25 seconds.  
\* When exiting without pressing set button, the manipulated value is not reflected.

### <Thermistor Table>

Temperature sensor selection		Function
01	Remote controller	Operation in remote controller temperature sensor
02	Indoor unit	Operation in indoor unit temperature sensor
03	2TH	Cooling Operation of higher temperature by comparing indoor unit's and wired remote controller's temperature. (There are products that operate at a lower temperature.)
		Heating Operation of lower temperature by comparing indoor unit's and wired remote controller's temperature.

\* The function of 2TH has different operation characteristics according to the product.

## Installer Setting-Group Setting

It is a function for settings in group control, or 2-remote controller control.

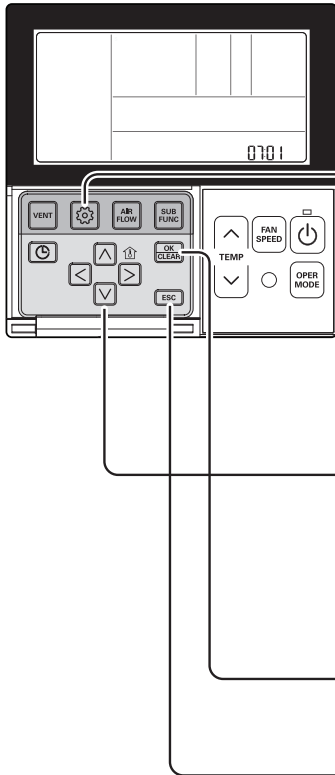

**1** If pressing button long for 3 seconds, it enters into remote controller setter setup mode.  
- If pressing once shortly, it enters into user setup mode. Please press more than 3 seconds for sure.

**2** If pressing button repeatedly, it moves to master/slave selection menu as picture below.

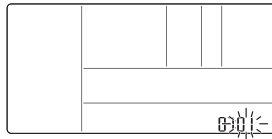

**3** Select Master/ Slave by pressing button.  
(00: Slave, 01: Master)

0701  
Function Code    Master/Slave value

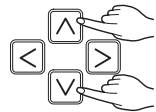

**4** Press button to save.

0701



**5** Pressing button will exit settings mode.  
\* After setup, it automatically gets out of setup mode if there is no button input for 25 seconds.  
\* When exiting without pressing set button, the manipulated value is not reflected.

Remote controller	Function
Master	Indoor unit operates based on master remote controller at group control. (Master is set when delivering from the warehouse.)
Slave	Setup all remote controllers except one master remote controller to slave at group control

\* Refer to the 'group control' part for details

• When controlling in groups, basic operation settings, airflow strength weak/medium/strong, lock setting of the remote controller, time settings, and other functions may be restricted.



## Installer Setting-Dry Contact Mode Setting

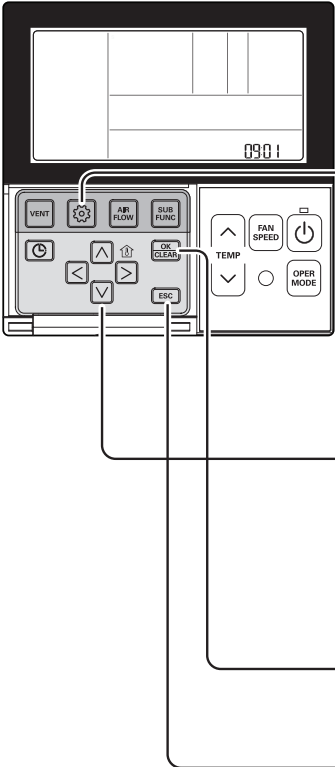

Dry contact function is the function that is possible to use only when dry contact equipment is separately purchased/setup.

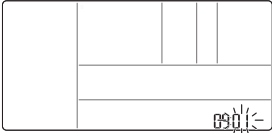

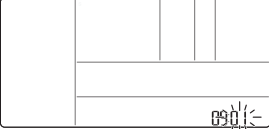

- 1** If pressing  button long for 3 seconds, it enters into remote controller setter setup mode.  
- If pressing once shortly, it enters into user setup mode. Please press more than 3 seconds for sure.

- 2** If pressing  button repeatedly, it moves to remote controller dry contact mode setup menu as picture below.

- 3** Select Dry contact setting by   pressing button.  
(00 : Automatic, 01 : manual)

- 4** Press  button to save.

- 5** Pressing  button will exit settings mode.  
\* After setup, it automatically gets out of setup mode if there is no button input for 25 seconds.  
\* When exiting without pressing set button, the manipulated value is not reflected.

### ► What is Dry Contact?

Like hotel card key and body perception sensor, it is the signal of the point of contact when using air-conditioner by interlocking.

• Please refer to dry contact manual for more details.

## Installer Setting-Celsius / Fahrenheit Switching

This function is used for switching the display between Celsius and Fahrenheit.  
(Optimized only for U.S.A)

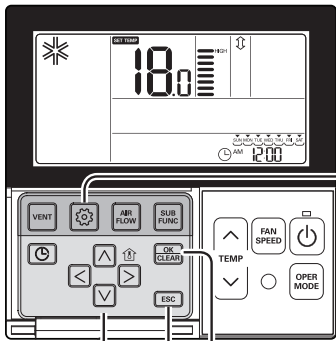



**1** If pressing  button long for 3 seconds, it enters into remote controller setter setup mode.  
- If pressing once shortly, it enters into user setup mode.  
Please press more than 3 seconds for sure.



**2** Repeat pressing  button to select Function code 12.

12:00  
↓                      ↓  
Function Code    conversion mode value

Ex) Fahrengit Setting

**3** Select Temperature unit mode by pressing   button.  
(00: Celsius, 01: Fahrenheit)

12:01

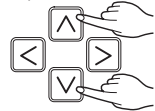

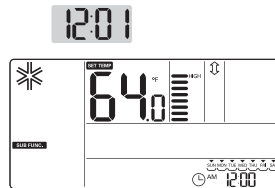

**4** Press  button to save or release.



**5** Press  button to exit or system will automatically exit after 25 seconds without any input.



\* Whenever press   button in Fahrenheit mode, the temperature will increase/drop 2 degrees.

# Installer Setting -Optional Function Setting

Setting feature for indoor unit when air cleaning / heater / humidifier / Up/down grill / Ventilation KIT / Auxiliary Heater is newly installed, or installed unit is removed.

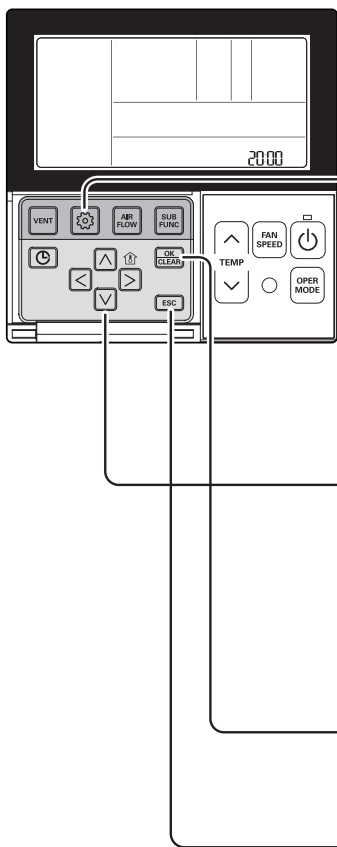



- 1** If pressing button long for 3 seconds, it enters into remote controller setter setup mode.  
- If pressing once shortly, it enters into user setup mode. Please press more than 3 seconds for sure.

- 2** If pressing button repeatedly, it moves to the selected option function code as picture below.

Function	Code
Plasma purification	20
Electric heater	21
Dehumidifier	22
Elevation grill	23
Ventilation kit	24
Auxiliary heater	25
- 3** Select existing condition of each mode by pressing button.  
(00: not installed, 01 : installed)

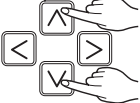
  
 Function Code    Existing condition



- 4** Press button to save.



- 5** Pressing button will exit settings mode.  
\* After setup, it automatically gets out of setup mode if there is no button input for 25 seconds.  
\* When exiting without pressing set button, the manipulated value is not reflected.

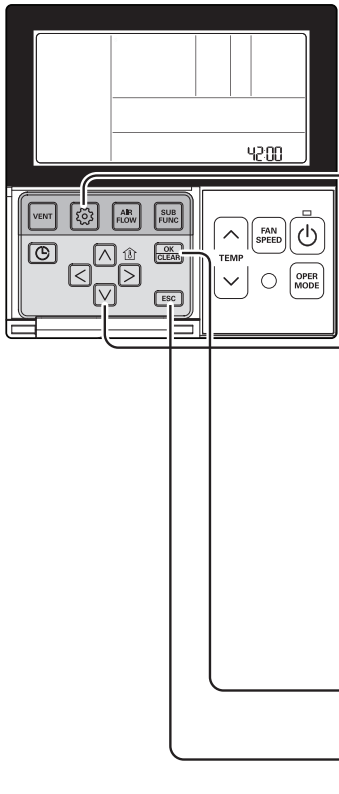

## Installer Setting – Remote controller Mode Lock

This function is used to limit 'operation-mode' selection setting.



**1** Press and hold  button for more than 3 seconds to enter the installer settings mode.

**2** Move to the installer code number 42 in the menu using  button.

**3** Select the remote control master/slave using   button.

  
 Code value for mode lock setting      Set value

code	Description
42:00	Doesn't limit operation mode setting.
42:01	User can setting to cooling mode only.
42:02	User can setting to heating mode only.

**4** Press  button to save the setting.

**5** Press  button to exit.

\* It can limit only wired remote controller button. other controllers can change operation mode. (for example wireless remote controller and central controller)

# How to Set E.S.P.?

## Installer Setting -E.S.P.

This is the function that decides the strength of the wind for each wind level and because this function is to make the installation easier.

- If you set ESP incorrectly, the air conditioner may malfunction.
- This setting must be carried out by a certificated-technician.

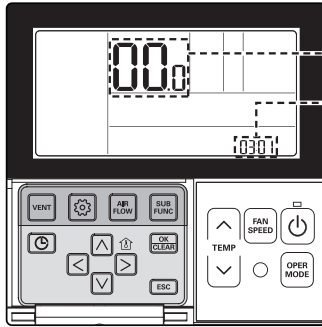

ESP value

Function code,  
ESP code

- 1** If pressing button long for 3 seconds, it enters into remote controller setter setup mode.  
- If pressing once shortly, it enters into user setup mode. Please press more than 3 seconds for sure.



- 2** If entering into ESP setup mode by using button, it indicates as the picture below.

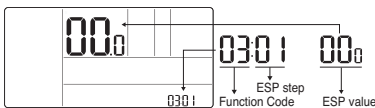

- 3** Select ESP fan step by pressing button.  
(01: very low, 02: low, 03: medium, 04: high, 05: very high)

0301

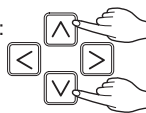

- 4** Move to ESP value setting by pressing button.  
(It is 000 when delivering from the warehouse.)

0301 00.0

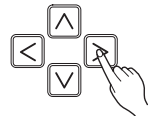

- 5** Press button to setup ESP value.  
(It is possible to setup ESP value from 1 to 255, and 1 is the smallest and 255 is the biggest.)

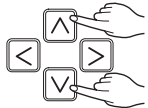

- 6** Select ESP fan step again by using button and setup ESP value, as No. 4 and 5, that corresponds each wind flow

- 7** Press button to save.



- 8** Press button to exit.  
\* After setup, it automatically gets out of setup mode if there is no button input for 25 seconds.  
\* When exiting without pressing set button, the manipulated value is not reflected.

- When setting ESP value on the product without very weak wind or power wind function, it may not work.
- Please be careful not to change the ESP value for each fan step.
- It does not work to setup ESP value for very low/power step for some products.
- ESP value is available for specific range belongs to the product.

## Installer Setting - Static Pressure Step Setting

This function is applied to only duct type. Setting this in other cases will cause malfunction.

This function is only available on some products.

This is the function that static pressure of the product is divided in 11 steps for setting.

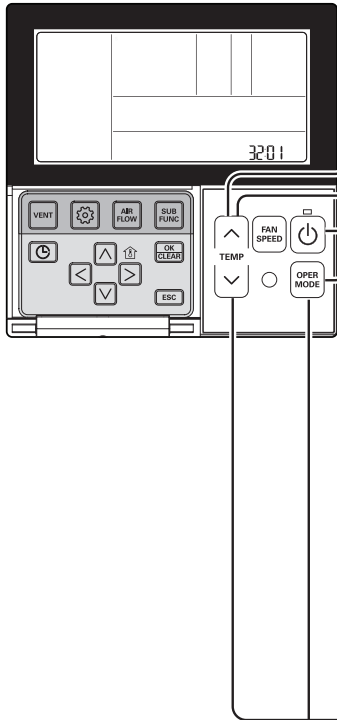

**1** When pressing the button and button simultaneously for more than 3 seconds, the system will be entered into the installer setting mode.

- After entering into the installer setting mode, select the static pressure step setting code value by pressing the button.

\* Static pressure step setting code value : 32

**2** Select the desired setting value with the temperature up() , down() button.

32.0 1

Function Code Existing condition

00: use static pressure (code 06) set value

01~ 11: static pressure step (code 32) set value

**3** When pressing button, currently established static pressure value will be set up.

**4** When pressing the button and button simultaneously for more than 3 seconds after the setting has been completed, the setting mode will be released.

- If there isn't any button input for more than 25 seconds, the installer setting mode will also be released.

- Static Pressure (Code 06) setting will not be used if Static Pressure Step (Code 32) setting is being used.

- For the static pressure value for each step, refer to the next page Table. 1

**Ceiling Concealed Duct – Low static****Table 1**

Model	Step	CMM	Static Pressure [mmAq (Pa)]					
			0(0)	1(10)	2(20)	3(29)	4(39)	5(49)
			Setting Value					
			32:01	32:02	32:03	32:04	32:05	32:06
CB09L.N12	LOW	5.5	69	76	83	91	101	111
	MID	7	81	87	94	101	109	117
	HIGH	9	97	103	108	117	124	131

Model	Step	CMM	Static Pressure [mmAq (Pa)]					
			0(0)	1(10)	2(20)	3(29)	4(39)	5(49)
			Setting Value					
			32:01	32:02	32:03	32:04	32:05	32:06
CB12L.N22	LOW	7	78	82	87	93	100	107
	MID	8.5	87	91	94	100	108	116
	HIGH	10	96	100	103	109	117	125

Model	Step	CMM	Static Pressure [mmAq (Pa)]					
			0(0)	1(10)	2(20)	3(29)	4(39)	5(49)
			Setting Value					
			32:01	32:02	32:03	32:04	32:05	32:06
CB18L.N22	LOW	10	96	100	103	109	117	125
	MID	12.5	109	113	117	123	130	137
	HIGH	15	120	124	129	134	141	147

Model	Step	CMM	Static Pressure [mmAq (Pa)]					
			0(0)	1(10)	2(20)	3(29)	4(39)	5(49)
			Setting Value					
			32:01	32:02	32:03	32:04	32:05	32:06
CB24L.N32	LOW	12	89	95	102	106	120	130
	MID	16	102	108	115	125	131	139
	HIGH	20	125	131	136	141	144	147

**Note :**

1. The above table shows the correlation between the air rates and E.S.P.
2. Be sure to set the value referring table 1. Unexpected set value will cause mal-function.
3. Table 1 is based at 230 V. According to the fluctuation of voltage, air flow rate varies.

**Ceiling Concealed Duct – Mid static**

**Table 2**

Model	Step	CMM	Static Pressure[mmAq(Pa)]										
			2(20)	2.5(25)	3(29)	4(39)	6(59)	8(78)	10(98)	12(118)	13(127)	14(137)	15(147)
			Setting Value										
			32:01	32:02	32:03	32:04	32:05	32:06	32:07	32:08	32:09	32:10	32:11
CM18.N14	LOW	13	73	74	77	88	93	103	111	117	120	125	128
	MID	14.5	76	77	85	91	97	107	114	121	125	128	131
	HIGH	16.5	85	87	90	94	103	110	118	125	128	131	134
CM24.N14	LOW	14.5	76	77	85	89	97	107	114	121	125	128	131
	MID	16.5	85	87	90	94	103	110	118	125	128	131	134
	HIGH	18	90	92	95	99	108	115	122	129	132	135	138

Model	Step	CMM	Static Pressure[mmAq(Pa)]										
			2.5(25)	4(39)	5(49)	6(59)	7(69)	8(78)	9(88)	10(98)	11(108)	13(127)	15(147)
			Setting Value										
			32:01	32:02	32:03	32:04	32:05	32:06	32:07	32:08	32:09	32:10	32:11
UM30.N14	LOW	18	96	102	107	110	114	118	122	125	127	132	134
	MID	20	102	110	114	118	121	125	127	130	133	135	137
	HIGH	22	110	117	121	124	127	130	133	136	137	138	140

Model	Step	CMM	Static Pressure[mmAq(Pa)]										
			4(39)	5(49)	6(59)	7(69)	8(78)	9(88)	10(98)	11(108)	12(118)	13(127)	15(147)
			Setting Value										
			32:01	32:02	32:03	32:04	32:05	32:06	32:07	32:08	32:09	32:10	32:11
UM36.N24	LOW	24	88	91	95	100	101	108	113	115	118	121	128
	MID	28	93	97	101	105	108	115	118	120	124	127	134
	HIGH	32	101	105	109	112	115	119	123	126	128	133	137

Model	Step	CMM	Static Pressure[mmAq(Pa)]										
			5(49)	6(59)	7(69)	8(78)	9(88)	10(98)	11(108)	12(118)	13(127)	14(137)	15(147)
			Setting Value										
			32:01	32:02	32:03	32:04	32:05	32:06	32:07	32:08	32:09	32:10	32:11
UM42.N24	LOW	28	100	103	106	110	114	118	121	125	128	133	136
	MID	33	108	111	114	118	122	125	128	131	134	138	141
	HIGH	38	117	120	124	127	130	133	135	138	141	144	147

Model	Step	CMM	Static Pressure[mmAq(Pa)]										
			4(39)	5(49)	6(59)	7(69)	8(78)	9(88)	10(98)	11(108)	12(118)	13(127)	15(147)
			Setting Value										
			32:01	32:02	32:03	32:04	32:05	32:06	32:07	32:08	32:09	32:10	32:11
UM48.N34 UM36ISL.N30	LOW	28	74	76	79	82	89	92	94	96	99	102	107
	MID	34	78	82	84	89	94	96	98	101	104	106	112
	HIGH	40	83	89	92	94	98	100	102	105	108	110	116

Model	Step	CMM	Static Pressure[mmAq(Pa)]										
			4(39)	5(49)	6(59)	7(69)	8(78)	9(88)	10(98)	11(108)	12(118)	13(127)	15(147)
			Setting Value										
			32:01	32:02	32:03	32:04	32:05	32:06	32:07	32:08	32:09	32:10	32:11
UM60.N34	LOW	40	82	89	92	94	98	100	102	105	108	110	113
	MID	45	90	92	96	98	102	104	106	109	112	114	117
	HIGH	50	94	97	100	104	107	109	112	115	117	119	121

**NOTE**

1. Be sure to set the value referring table 2. Unexpected set value will cause mal-function.
2. Table 2 is based at 230 V. According to the fluctuation of voltage, air flow rate varies.
3. Factory Set(External Static Pressure) each Model

Model	Factory set (E.S.P.) mmAq(Pa)
CM18.N14	6(59)
CM24.N14	
UM30.N14	
UM36.N24	
UM36ISL.N30	
UM42.N24	
UM48.N34	
UM60.N34	

\* If it is zero static pressure, please set value below Maximum value.

Model	Maximum value
CM18.N14	115
CM24.N14	
UM30.N14	
UM36.N24	120
UM42.N24	
UM36ISL.N30	98
UM48.N34	
UM60.N34	

**Ceiling Concealed Duct – H-INV**

**Table 3**

Model	Step	CMM	Static Pressure [mmAq (Pa)]					
			4(39)	5(49)	6(59)	8(78)	10(98)	12(118)
			Setting Value					
			32:01	32:02	32:03	32:04	32:05	32:06
UB36H.NR3	LOW	21	68	72	78	84	91	97
	MID	28	75	79	84	89	95	101
	HIGH	34	81	85	88	94	100	105

Model	Step	CMM	Static Pressure [mmAq (Pa)]					
			4(39)	5(49)	6(59)	8(78)	10(98)	12(118)
			Setting Value					
			32:01	32:02	32:03	32:04	32:05	32:06
UB42H.NR3	LOW	24		75	79	86	93	98
	MID	31		81	85	91	98	103
	HIGH	37		88	91	97	102	107

Model	Step	CMM	Static Pressure [mmAq (Pa)]					
			4(39)	5(49)	6(59)	8(78)	10(98)	12(118)
			Setting Value					
			32:01	32:02	32:03	32:04	32:05	32:06
UB48H.NR3	LOW	28		79	84	89	95	101
	MID	34		85	88	94	100	105
	HIGH	40		91	93	99	105	110

**NOTE**

Be sure to set the value referring table 3. Unexpected set value will cause mal-function.

As far as possible do not set ESP 82,83

Table 3 is based at 230 V. According to the fluctuation of voltage, air flow rate varies.

**Ceiling Concealed Duct – High static****Table 4**

Model	Step	CMM	Static Pressure[mmAq(Pa)]										
			6(59)	7(69)	8(78)	9(88)	10(98)	12(118)	13(127)	14(137)	15(147)	16(157)	18(176)
			Setting Value										
			32:01	32:02	32:03	32:04	32:05	32:06	32:07	32:08	32:09	32:10	32:11
UB70.N94	LOW	60	70	72	74	76	78	81	82	85	86	88	91
	MID	65	74	76	78	80	82	85	86	89	90	92	95
	HIGH	70	78	80	82	84	86	90	91	93	94	96	99

Model	Step	CMM	Static Pressure[mmAq(Pa)]										
			6(59)	7(69)	8(78)	9(88)	10(98)	12(118)	13(127)	14(137)	15(147)	16(157)	18(176)
			Setting Value										
			32:01	32:02	32:03	32:04	32:05	32:06	32:07	32:08	32:09	32:10	32:11
UB85.N94	LOW	64	74	75	76	78	79	82	84	86	89	91	95
	MID	72	78	79	80	82	83	87	89	91	94	96	100
	HIGH	80	82	84	86	88	90	93	95	97	100	101	105

**NOTE**

1. Be sure to set the value referring table 4. Unexpected set value will cause mal-function.
2. Table 4 is based at 230V. According to the fluctuation of voltage, air flow rate varies.
3. Factory Set(External Static Pressure) each Model

Model	Factory set (E.S.P.) mmAq(Pa)
UB85.N94 UB70.N94	13 (127)

\* If it is zero static pressure, please set value below Maximum value.

Model	Maximum value
UB85.N94 UB70.N94	105

**Ceiling Concealed Duct – Compact****Table 5**

Capacity	Step	C.M.M	Static Pressure(mmAq)					
			2.5	4	5	6	8	10
			Setting Value					
18 k	HIGH	13.5	102	112	119	125	-	-
	MID	12	96	106	114	119	-	-
	LOW	10.5	90	102	108	114	-	-
24 k	HIGH	18	121	131	137	142	-	-
	MID	16.5	115	125	130	135	-	-
	LOW	14	106	116	121	125	-	-

# Self-diagnosis Function

## Indoor Unit Error

Ex) Error 03 (Remote controller error)

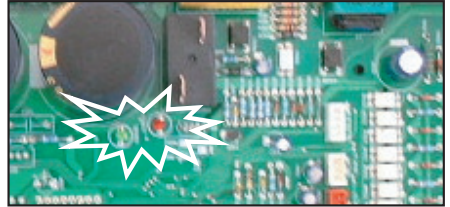
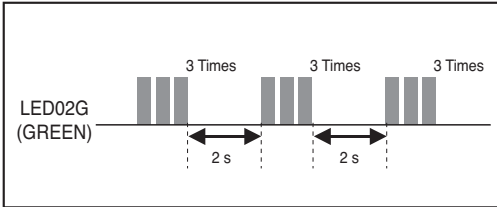

Error Code	Description	LED 1 (Red)	LED 2 (Green)	Indoor status
01	Indoor Room sensor error	0	1 time ●	OFF
02	Indoor in-pipe sensor error	0	2 times ●	OFF
03	Remote controller error	0	3 times ●	OFF
04	Drain pump error	0	4 times ●	OFF
05	Communication error indoor and outdoor	0	5 times ●	OFF
06	Indoor out-pipe sensor error	0	6 times ●	OFF
09	EEPROM error (indoor)	0	9 times ●	OFF
10	BLDC motor fan lock (indoor)	1 time ●	0	OFF

\* Because remote controller turn off when occur ERROR in simultaneous operation system, it should check LED blinks of outdoor in order to confirm error code.

\* Repeatedly after LED1 is turned on and off as the Error code number of tens digit, LED2 is turned on and off as the Error code number of single-digit.

## DIP Switch Setting

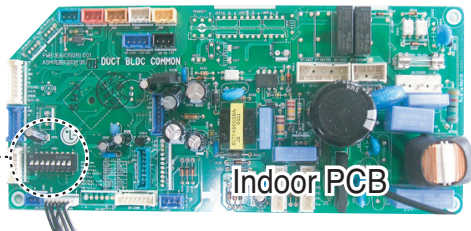
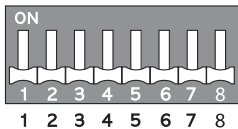

Function	Description	Setting Off	Setting On	Default	
SW3	Group Control	Selection of Master or Slave	Master	Slave	Off
SW4	Dry Contact Mode	Selection of Dry Contact Mode	Wired/Wireless remote controller Selection of Manual or Auto operation Mode	Auto	Off
SW5	Installation	Fan continuous operation	Continuous operation Removal	Working	Off

