



INSTALLATION MANUAL

AIR CONDITIONER

Please read this installation manual completely before installing the product. Installation work must be performed in accordance with the national wiring standards by authorized personnel only. Please retain this installation manual for future reference after reading it thoroughly.

Original instruction



MFL71666401
Rev.08_102225

www.lg.com
Copyright © 2019 - 2025 LG Electronics Inc. All Rights Reserved.

РУССКИЙ ЯЗЫК

ENGLISH

УКРАЇНСЬКА

ITALIANO

ҚАЗАҚ ТІЛІ

ESPAÑOL

БЕЛАРУСКАЯ МОВА

FRANÇAIS

ЎЗБЕК ТИЛИ

DEUTSCH

ΕΛΛΗΝΙΚΑ

ČEŠTINA

NETERLANDS

POLSKI

LIMBA ROMÂNĂ

MODEL DESIGNATION

Product information

- Product Name : Air conditioner
- Model Name :
 - Indoor Unit for Multi System

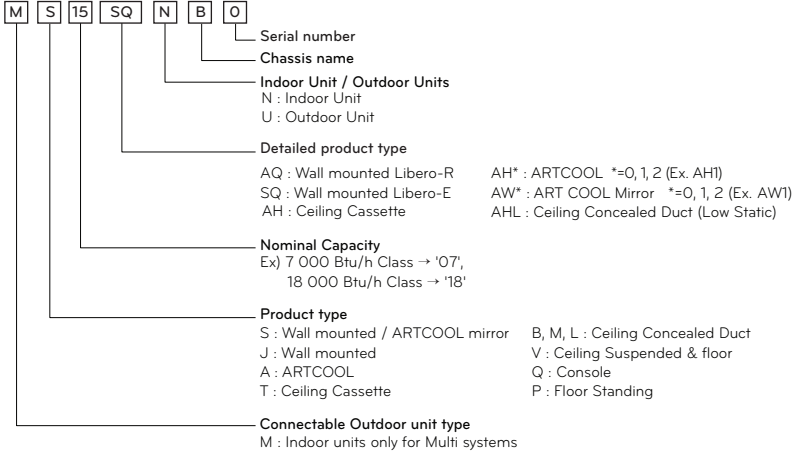

- Indoor units only for Single A Systems
- Common Indoor Unit for Multi and Single CAC

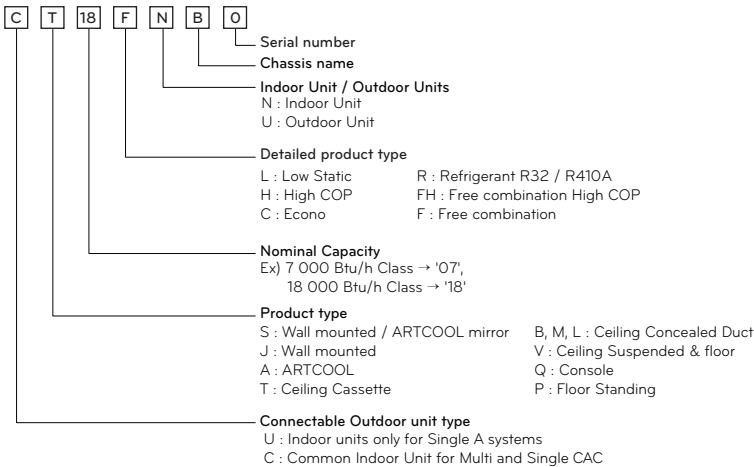

- Additional Information : serial number is refer to the barcode on the product.
- Maximum allowable pressure High side : 4.2 MPa / 4.32 MPa (it can be different by model)
 Maximum allowable pressure Low side : 2.4 MPa
- Refrigerant : R32

Airborne Noise Emission

The A-weighted sound pressure emitted by this product is below 70 dB.

** The noise level can vary depending on the site.

The figures quoted are emission level and are not necessarily safe working levels.

Whilst there is a correlation between the emission and exposure levels, this cannot be used reliably to determine whether or not further precautions are required.

Factor that influence the actual level of exposure of the workforce include the characteristics of the work room and the other sources of noise, i.e. the number of equipment and other adjacent processes and the length of time for which an operator exposed to the noise. Also, the permissible exposure level can vary from country to country.

This information, however, will enable the user of the equipment to make a better evaluation of the hazard and risk.

TIPS FOR SAVING ENERGY

Here are some tips that will help you minimize the power consumption when you use the air conditioner.

You can use your air conditioner more efficiently by referring to the instructions below:

- Do not cool excessively indoors. This may be harmful for your health and may consume more electricity.
- Block sunlight with blinds or curtains while you are operating the air conditioner.
- Keep doors or windows closed tightly while you are operating the air conditioner.
- Adjust the direction of the air flow vertically or horizontally to circulate indoor air.
- Speed up the fan to cool or warm indoor air quickly, in a short period of time.
- Open windows regularly for ventilation as the indoor air quality may deteriorate if the air conditioner is used for many hours.
- Clean the air filter once every 2 weeks. Dust and impurities collected in the air filter may block the air flow or weaken the cooling / dehumidifying functions.

For your records

Staple your receipt to this page in case you need it to prove the date of purchase or for warranty purposes.

Write the model number and the serial number here:

Model number : _____

Serial number : _____





You can find them on a label on the side of each unit.

Dealer's name : _____

Date of purchase : _____

SAFETY INSTRUCTIONS

The following symbols are displayed on indoor and outdoor units.

	Read the precautions in this manual carefully before operating the unit.		This appliance is filled with flammable refrigerant.(for R32)
	This symbol indicates that the Operation Manual should be read carefully.		This symbol indicates that a service personnel should be handling this equipment with reference to the Installation Manual.

The following safety guidelines are intended to prevent unforeseen risks or damage from unsafe or incorrect operation of the appliance.

The guidelines are separated into 'WARNING' and 'CAUTION' as described below.

 This symbol is displayed to indicate matters and operations that can cause risk.
Read the part with this symbol carefully and follow the instructions in order to avoid risk.

WARNING

This indicates that the failure to follow the instructions can cause serious injury or death.

CAUTION

This indicates that the failure to follow the instructions can cause the minor injury or damage to the product.

WARNING

- Installation or repairs made by unqualified persons can result in hazards to you and others.
- The information contained in the manual is intended for use by a qualified service technician familiar with safety procedures and equipped with the proper tools and test instruments.

- Failure to carefully read and follow all instructions in this manual can result in equipment malfunction, property damage, personal injury and/or death.
- Compliance with national gas regulations shall be observed.
- Ducts connected to an appliance shall not contain an ignition source. (for R32)

Installation

- Always perform grounding.
 - Otherwise, it may cause electrical shock.
- Don't use a power cord, a plug or a loose socket which is damaged.
 - Otherwise, it may cause a fire or electrical shock.
- For installation of the product, always contact the service center or a professional installation agency.
 - Otherwise, it may cause a fire, electrical shock, explosion or injury.
- Securely attach the electrical part cover to the indoor unit and the service panel to the outdoor unit.
 - If the electrical part cover of the indoor unit and the service panel of the outdoor unit are not attached securely, it could result in a fire or electric shock due to dust, water, etc.
- Always install an air leakage breaker and a dedicated switching board.
 - No installation may cause a fire and electrical shock.
- Do not keep or use flammable gases or combustibles near the air conditioner.
 - Otherwise, it may cause a fire or the failure of product.
- Ensure that an installation frame of the outdoor unit is not damaged due to use for a long time.
 - It may cause injury or an accident.
- Do not disassemble or repair the product randomly.
 - It will cause a fire or electrical shock.

- Do not install the product at a place that there is concern of falling down.
 - Otherwise, it may result in personal injury.
- Use caution when unpacking and installing.
 - Sharp edges may cause injury.
- The appliance shall be stored in a room without continuously operating open flames (for example an operating gas appliance) and ignition sources (for example an operating electric heater).
- Two or more people must lift and transport the product. Avoid personal injury.
- Do not use means to accelerate the defrosting process or to clean, other than those recommended by the manufacturer.
- Do not pierce or burn refrigerant cycle part.
- Be aware that refrigerants may not contain an odour.
- Keep any required ventilation openings clear of obstruction.
- The appliance shall be stored in a well-ventilated area where the room size corresponds to the room area as specified for operation. (for R32)
- Refrigerant tubing shall be protected or enclosed to avoid damage.
- Flexible refrigerant connectors (such as connecting lines between the indoor and outdoor unit) that may be displaced during normal operations shall be protected against mechanical damage.
- A brazed, welded, or mechanical connection shall be made before opening the valves to permit refrigerant to flow between the refrigerating system parts.
- Mechanical connections shall be accessible for maintenance purposes.
- The appliance shall be disconnected from its power source during service and when replacing parts.
- The appliance shall be installed in accordance with national wiring regulations.

Operation

- Do not share the outlet with other appliances.
 - It will cause an electric shock or a fire due to heat generation.
- Do not use the damaged power cord.
 - Otherwise, it may cause a fire or electrical shock.
- Do not modify or extend the power cord randomly.
 - Otherwise, it may cause a fire or electrical shock.
- Take care so that the power cord may not be pulled during operation.
 - Otherwise, it may cause a fire or electrical shock.
- Unplug the unit if strange sounds, smell, or smoke comes from it.
 - Otherwise, it may cause electrical shock or a fire.
- Keep the flames away.
 - Otherwise, it may cause a fire.
- Take the power plug out if necessary, holding the head of the plug and do not touch it with wet hands.
 - Otherwise, it may cause a fire or electrical shock.
- Do not use the power cord near the heating tools.
 - Otherwise, it may cause a fire and electrical shock.
- Do not open the suction inlet of the indoor/outdoor unit during operation.
 - Otherwise, it may electrical shock and failure.
- Do not allow water to run into electrical parts.
 - Otherwise, it may cause the failure of machine or electrical shock.
- Hold the plug by the head when taking it out.
 - It may cause electric shock and damage.
- Never touch the metal parts of the unit when removing the filter.
 - They are sharp and may cause injury.
- Do not step on the indoor/outdoor unit and do not put anything on it.
 - It may cause an injury through dropping of the unit or falling down.
- Do not place a heavy object on the power cord.
 - Otherwise, it may cause a fire or electrical shock.

- When the product is submerged into water, always contact the service center.
 - Otherwise, it may cause a fire or electrical shock.
- Take care so that children may not step on the outdoor unit.
 - Otherwise, children may be seriously injured due to falling down.
- Use a vacuum pump or inert (nitrogen) gas when doing leakage test or air purge. Do not compress air or oxygen, and do not use flammable gases. Otherwise, it may cause fire or explosion.
 - There is the risk of death, injury, fire or explosion.
- Do not turn on the breaker or power under condition that front panel, cabinet, top cover, control box cover are removed or opened.
 - Otherwise, it may cause fire, electric shock, explosion or death.
- Turn off all devices that cause fire when the refrigerant leaks., ventilate the room (example : opening window or using ventilation unit), and contact with dealer who you purchased the unit.
- The installation of pipe-work shall be kept to a minimum.
- When mechanical connectors are reused indoors, sealing parts shall be renewed. (for R32)
- When flared joints are reused indoors, the flare part shall be re-fabricated. (for R32)

CAUTION

Installation

- Install the drain hose to ensure that drain can be securely done.
 - Otherwise, it may cause water leakage.
- Install the product so that the noise or hot wind from the outdoor unit may not cause any damage to the neighbors.
 - Otherwise, it may cause dispute with the neighbors.
- Always inspect gas leakage after the installation and repair of product.
 - Otherwise, it may cause the failure of product.

- Keep level parallel in installing the product.
 - Otherwise, it may cause vibration or water leakage.
- Any person who is involved with working on or breaking into a refrigerant circuit should hold a current valid certificate from an industry-accredited assessment authority, which authorises their competence to handle refrigerants safely in accordance with an industry recognized assessment specification. (for R32)
- Wear adequate personal protection equipment (PPE) when installing, maintaining or servicing the product.
- Pipe-work shall be protected from physical damage.
- Do not install the unit in potentially explosive atmospheres.

Operation

- Avoid excessive cooling and perform ventilation sometimes.
 - Otherwise, it may do harm to your health.
- Use a soft cloth to clean. Do not use wax, thinner, or a strong detergent.
 - The appearance of the air conditioner may deteriorate, change color, or develop surface flaws.
- Do not use an appliance for special purposes such as preserving animals vegetables, precision machine, or art articles.
 - Otherwise, it may damage your properties.
- Do not place obstacles around the flow inlet or outlet.
 - Otherwise, it may cause the failure of appliance or an accident.
- The appliance shall be stored so as to prevent mechanical damage from occurring.
- Servicing shall only be performed as recommended by the equipment manufacturer. Maintenance and repair requiring the assistance of other skilled personnel shall be carried out under the supervision of the person competent in the use of flammable refrigerants. (for R32)

- Dismantling the unit, treatment of the refrigerant oil and eventual parts should be done in accordance with local and national standards.
- Periodic (more than once/year) cleaning of the dust or salt particles stuck on the heat exchanger by using water.
- Means for disconnection must be incorporated in the fixed wiring in accordance with the wiring rules.
- This appliance is not intended for use by persons (including children) with reduced physical, sensory or mental capabilities or lack of experience and knowledge, unless they have been given supervision or instruction concerning use of the appliance by a person responsible for their safety.
Children should be supervised to ensure that they do not play with the appliance.
- This appliance can be used by children aged from 8 years and above and persons with reduced physical, sensory or mental capabilities or lack of experience and knowledge if they have been given supervision or instruction concerning use of the appliance in a safe way and understand the hazards involved. Children shall not play with the appliance. Cleaning and user maintenance shall not be made by children without supervision.

TABLE OF CONTENTS

2 MODEL DESIGNATION

4 TIPS FOR SAVING ENERGY

5 SAFETY INSTRUCTIONS

13 INTRODUCTION

18 INSTALLATION PLACES

18 Select the best Location

25 THE INDOOR UNIT INSTALLATION

26 Position of suspension Bolt

30 Fixing Installation Plate

31 Connecting the Piping

40 Open side-cover

41 Mounting the anchor nut and bolt

43 Indoor Unit Drain Piping

45 Drain test

47 Wiring Connection

51 Electrical Wiring

52 Flaring Work

54 Test Running

56 Heating Only Mode

57 SMART DIAGNOSIS (Optional)

58 Manual the decor, air filter Assembly & Disassembly

60 INSTALLATION OF DECORATIVE PANEL(Accessory)

64 INSTALLATION INSTRUCTIONS

64 Installer Setting - How to enter installer setting mode

65 Installer Setting - Installer Setting Code Table

66 Installer Setting - Setting Address of Central Control

66 Installer Setting - Checking Address of Central Control

67 Installer Setting - Static Pressure Step Setting

71 Installer Setting - Auto ESP





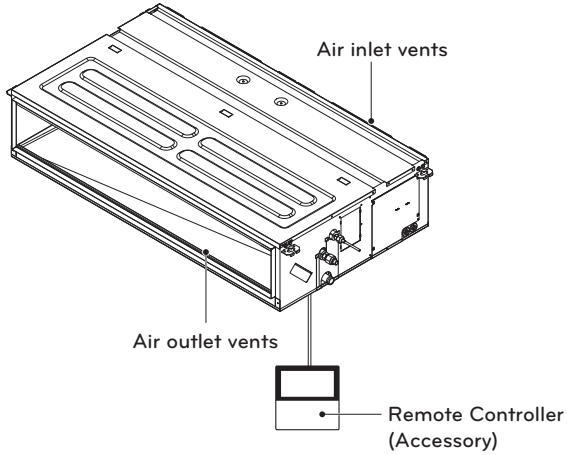

72 DIP SWITCH SETTING

INTRODUCTION

[Ceiling Concealed Duct]



Installation Tool

Name	Drain hose	Clamp metal	Washer for hanging bracket	Clamp (Tie Wrap)	Insulation for fitting	Other
Quantity	1 EA	2 EA	8 EA	4 EA	1 SET	- Manual
Shape					 For gas pipe  For liquid pipe	

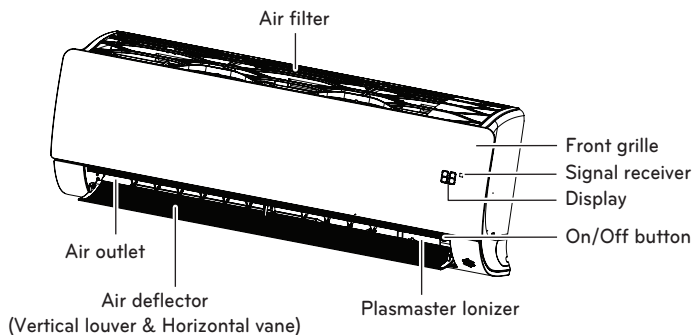
[Wall Mounted]

* The feature can be changed according to type of model.

NOTE

- When mechanical connectors are reused indoors, sealing parts shall be renewed.

Installation Tool





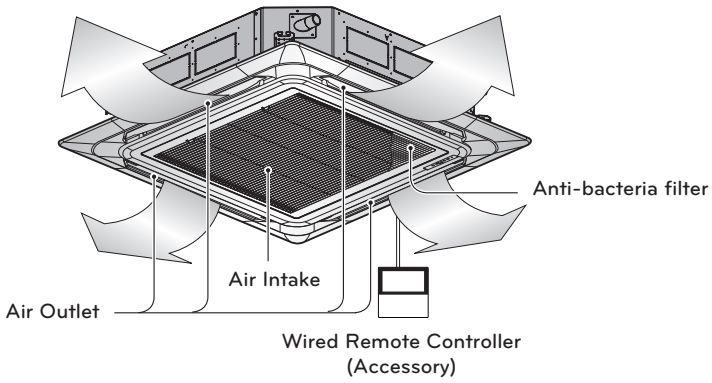

Name	Quantity	Shape
Installation plate	1 EA	<p>The feature can be changed according to type of model.</p>
Type "A" screw	5 EA	
Type "B" screw	2 EA	
Type "C" screw	2 EA	
Remote control holder	1 EA	<p>Type "B" screw</p>
Cloth tape	1 EA	
Connector	1 EA (5.0 kW) 2 EA (6.6 kW)	<p>5.0 kW : ① Ø9.52 (3/8) → Ø12.7 (1/2) 6.6 kW : ① Ø9.52 (3/8) → Ø12.7 (1/2) ② Ø15.88 (5/8) → Ø12.7 (1/2)</p>

(Other) Manual

[Ceiling Cassette]





Installation Tool

Name	Drain hose	Clamp metal	Washer for hanging bracket	Clamp (Tie Wrap)	Insulation for fitting	Other
Quantity	1 EA	2 EA	8 EA	4 EA	1 SET	- Paper pattern for installation - Manual
Shape					 For gas pipe  For liquid pipe	

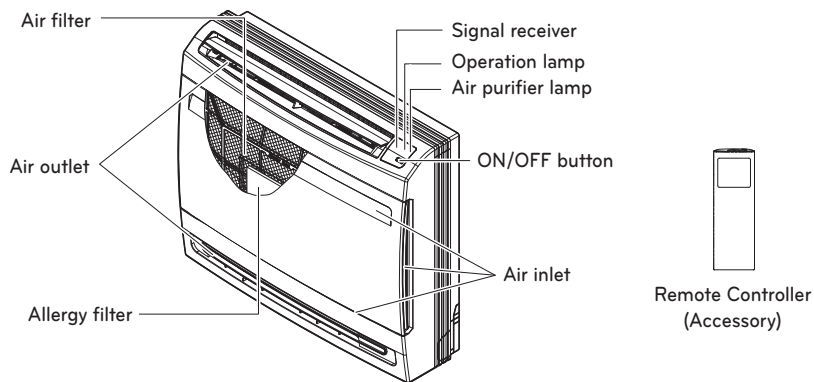
* Screws for fixing panels are attached to decoration panel.

[Console]**Installation Tool**

Name	Drain hose	Installation Plate	Other
Quantity	1 EA	1 EA	
Shape			<ul style="list-style-type: none"> - Remote Controller - Remote Controller Holder - Battery (AAA) - 2 EA - Allergy Filter - Fixing Screw for R.Controller Holder - 2 EA - Fixing screw for Installation Plate 4*25 mm - 5 EA - Wood screw for indoor fixation - 2 EA - Manual

[Ceiling suspended type]

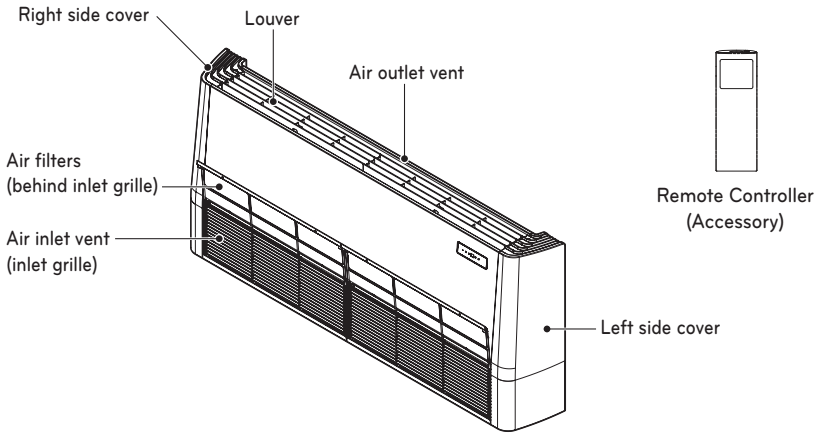

Installation Tool

Figure	Name	Figure	Name
	Screw driver		Multi-meter
	Electric drill		Hexagonal wrench
	Measuring tape, Knife		Ammeter
	Hole core drill		Gas-leak detector
	Spanner		Thermometer, Level
	Torque wrench		Flaring tool set

(Other) Manual

INSTALLATION PLACES

Select the best Location

[Ceiling Concealed Duct]

- The place shall easily bear a load exceeding four times the indoor unit's weight.
- The place shall be able to inspect the unit as the figure.
- The place where the unit shall be leveled.
- The place shall allow easy water drainage. (Suitable dimension "H" is necessary to get a slope to drain as figure.)
- The place shall easily connect with the outdoor unit.
- The place where the unit is not affected by an electrical noise.
- The place where air circulation in the room will be good .
- There should not be any heat source or steam near the unit.

Ceiling Concealed Duct – Low Static

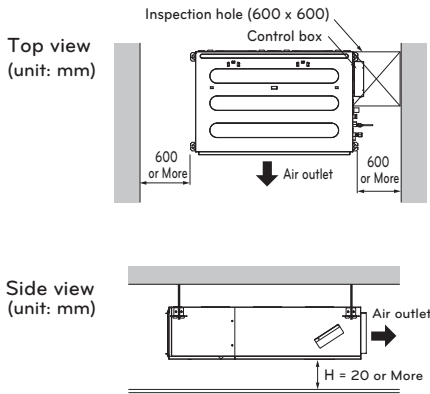

Ceiling Concealed Duct – Mid Static

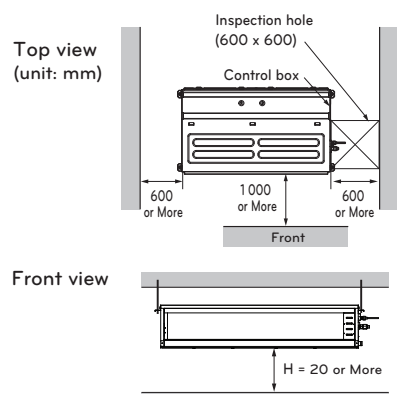

* Suitable dimension "H" is necessary to get a slope to drain as shown in the figure

CAUTION

- In case that the unit is installed near the sea, the installation parts may be corroded by salt. The installation parts (and the unit) should be taken appropriate anti-corrosion measures.

Inspection Hole Standard

Number of Inspection hole	Distance between False ceiling & Actual ceiling	Remarks
1	More than 100 cm	Sufficient space in the ceiling for servicing.
2	20 cm to 100 cm	Insufficient space. Difficult for servicing
Hole size should be more than the size of IDU.	Less than 20 cm	Minimum height for motor replacement.

[Wall Mounted]

- There should not be any heat or steam near the unit.
- Select a place where there are no obstacles around of the unit.
- Make sure that condensation drainage can be conveniently routed away.
- Do not install near a doorway.
- Ensure that the interval between a wall and the left (or right) of the unit is more than 100 mm. The unit should be installed as high as possible on the wall, allowing a minimum of 200 mm from ceiling.
- Use a metal detector to locate studs to prevent unnecessary damage to the wall.

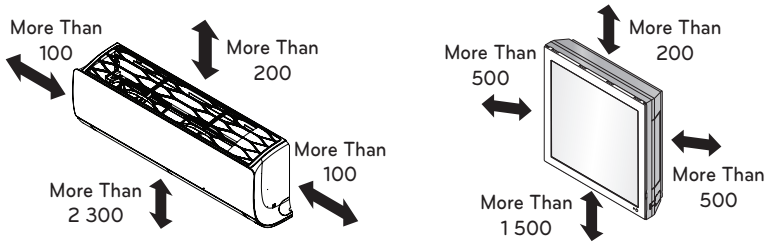

(Unit: mm)

* The feature can be changed according to type of model.

NOTE

The gap between the indoor unit and ceiling is needed more than 200 mm for disassemble the air filter.

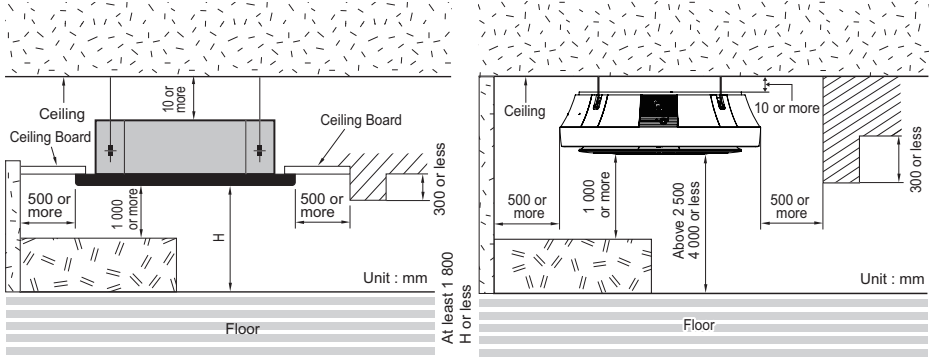

Chassis	H
TU	3 300
TQ / TR / TP / TP-B	3 600
TN / TM / TM-A	4 200

The basic installation for the round type should be in an exposed area.
Do not install at a non exposed installation site such as areas with ceiling texture.

* Please use an annexed sheet or the corrugated cardboard on the bottom of packing as installation sheet.

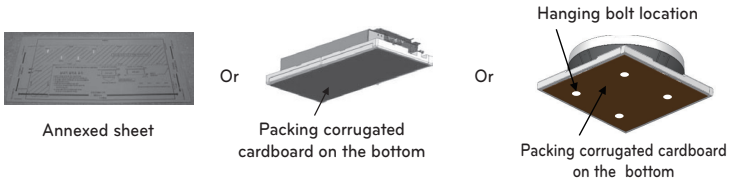

* When using the bottom sheet, please use it after separating the installation sheet from packing of the product floor by using a knife etc as a picture below.

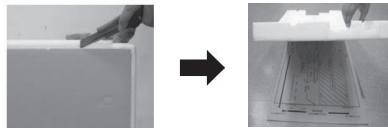

[Console]

- There should not be any heat or steam near the unit.
- Select a place where there are no obstacles around of the unit.
- Make sure that condensation drainage can be conveniently routed away.
- Do not install near a doorway.
- Ensure that the interval between a wall and the left (or right) of the unit is more than 300 mm.
- Use a metal detector to locate studs to prevent unnecessary damage to the wall.
- Keep away from electronic ignition type fluorescent lamps as they may shorten the remote controller range.
- Please check at least 1 m away from television or radio.(It cause interference with the picture or sound.)

NOTE

- Before choosing the installation site, please obtain user approval
- If the unit is installed below a window, check the interference of window curtain. (more than 300 mm)

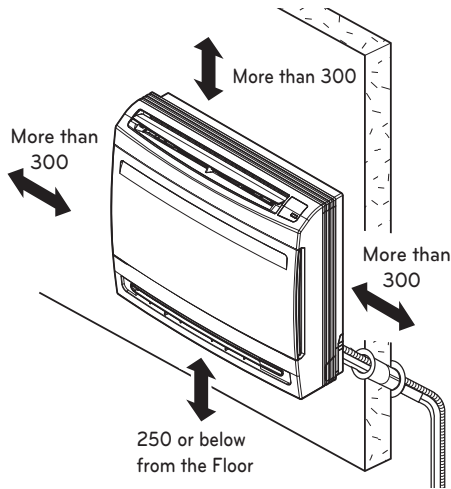

(Unit: mm)

[Ceiling suspended type]

- There should not be any heat source or steam near the unit.
- There should not be any obstacles to prevent the air circulation.
- A place where air circulation in the room will be good.
- A place where drainage can be easily obtained.
- A place where noise prevention is taken into consideration.
- Do not install the unit near the door way.
- Ensure the spaces indicated by arrows from the wall, ceiling, or other obstacles.
- The indoor unit must keep the maintenance space.

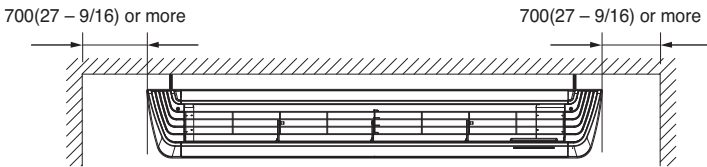
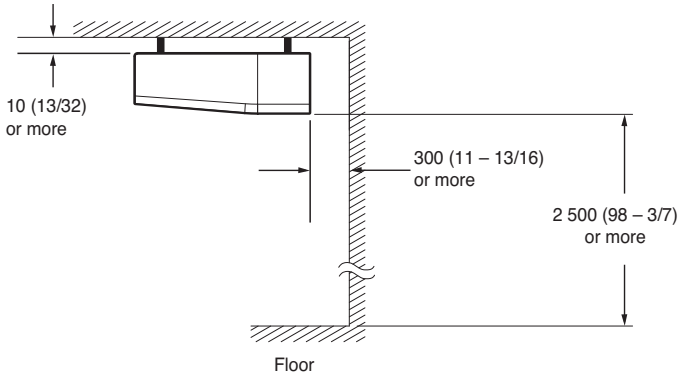

(Unit: mm)

Minimum floor area (for R32)(IEC 60335-2-40:2013+A1:2016 Edition 5.1)

- The appliance shall be installed, operated and stored in a room with a floor area larger than the minimum area.
- Use the graph of table to determine the minimum area.

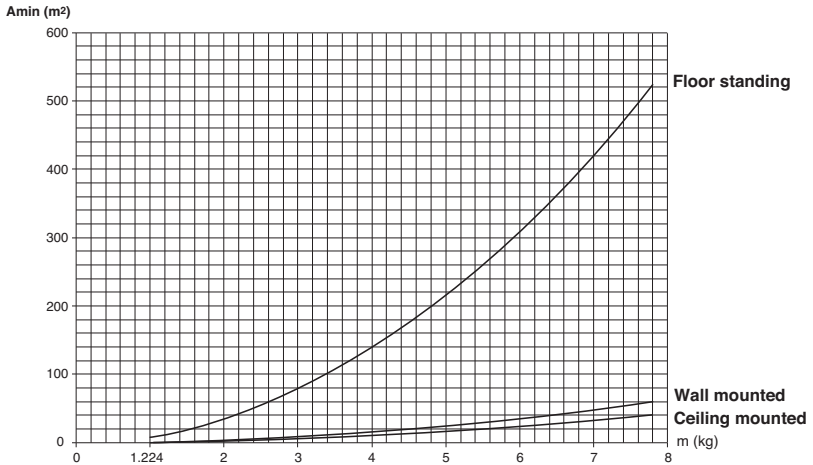

- m : Total refrigerant amount in the system
- Total refrigerant amount : factory refrigerant charge + additional refrigerant amount
- Amin : minimum area for installation

Floor standing	
m (kg)	Amin (m ²)
< 1.224	-
1.224	12.9
1.4	16.82
1.6	21.97
1.8	27.80
2	34.32
2.2	41.53
2.4	49.42
2.6	58.00
2.8	67.27
3	77.22
3.2	87.86
3.4	99.19
3.6	111.20
3.8	123.90
4	137.29
4.2	151.36
4.4	166.12

Floor standing	
m (kg)	Amin (m ²)
4.6	181.56
4.8	197.70
5	214.51
5.2	232.02
5.4	250.21
5.6	269.09
5.8	288.65
6	308.90
6.2	329.84
6.4	351.46
6.6	373.77
6.8	396.76
7	420.45
7.2	444.81
7.4	469.87
7.6	495.61
7.8	522.04

Wall mounted	
m (kg)	Amin (m ²)
< 1.224	-
1.224	1.43
1.4	1.87
1.6	2.44
1.8	3.09
2	3.81
2.2	4.61
2.4	5.49
2.6	6.44
2.8	7.47
3	8.58
3.2	9.76
3.4	11.02
3.6	12.36
3.8	13.77
4	15.25
4.2	16.82
4.4	18.46

Wall mounted	
m (kg)	Amin (m ²)
4.6	20.17
4.8	21.97
5	23.83
5.2	25.78
5.4	27.80
5.6	29.90
5.8	32.07
6	34.32
6.2	36.65
6.4	39.05
6.6	41.53
6.8	44.08
7	46.72
7.2	49.42
7.4	52.21
7.6	55.07
7.8	58.00

Ceiling Mounted	
m (kg)	Amin (m ²)
< 1.224	-
1.224	0.956
1.4	1.25
1.6	1.63
1.8	2.07
2	2.55
2.2	3.09
2.4	3.68
2.6	4.31
2.8	5.00
3	5.74
3.2	6.54
3.4	7.38
3.6	8.27
3.8	9.22
4	10.21
4.2	11.26
4.4	12.36

Ceiling Mounted	
m (kg)	Amin (m ²)
4.6	13.50
4.8	14.70
5	15.96
5.2	17.26
5.4	18.61
5.6	20.01
5.8	21.47
6	22.98
6.2	24.53
6.4	26.14
6.6	27.80
6.8	29.51
7	31.27
7.2	33.09
7.4	34.95
7.6	36.86
7.8	38.83

Minimum floor area (for R32)(IEC 60335-2-40:2018 Edition 6.0)

- The appliance shall be installed, operated and stored in a room with a floor area larger than the minimum area.
- Use the graph of table to determine the minimum area.
- Console model(For EU market) should be installed only in accordance with IEC 60335-2-40:2018 Edition 6.0.

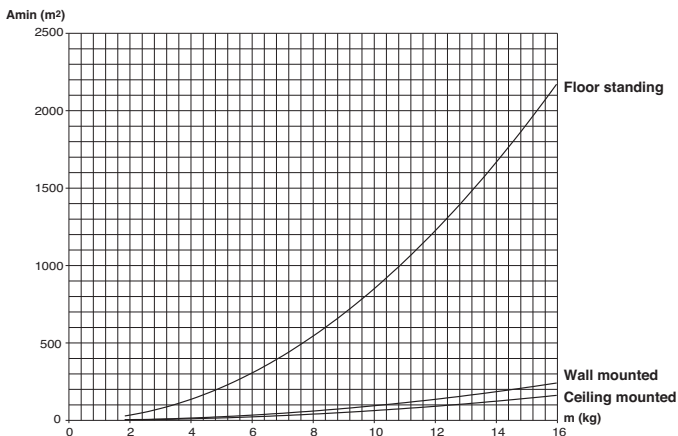

- m : Total refrigerant amount in the system
- Total refrigerant amount : factory refrigerant charge + additional refrigerant amount
- Amin : minimum area for installation

Floor standing		Floor standing		Wall mounted		Wall mounted		Ceiling Mounted		Ceiling Mounted	
m (kg)	Amin (m²)	m (kg)	Amin (m²)	m (kg)	Amin (m²)	m (kg)	Amin (m²)	m (kg)	Amin (m²)	m (kg)	Amin (m²)
< 1.842	-	9.00	689.38	< 1.842	-	9.00	76.60	< 1.842	-	9.00	51.28
1.842	28.88	9.20	720.36	1.842	4.44	9.20	80.04	1.842	3.64	9.20	53.58
2.00	34.04	9.40	752.02	2.00	4.83	9.40	83.56	2.00	3.95	9.40	55.94
2.20	41.19	9.60	784.36	2.20	5.31	9.60	87.15	2.20	4.34	9.60	58.34
2.40	49.02	9.80	817.38	2.40	5.79	9.80	90.82	2.40	4.74	9.80	60.80
2.60	57.53	10.00	851.08	2.60	6.39	10.00	94.56	2.60	5.13	10.00	63.30
2.80	66.72	10.20	885.47	2.80	7.41	10.20	98.39	2.80	5.53	10.20	65.86
3.00	76.60	10.40	920.53	3.00	8.51	10.40	102.28	3.00	5.92	10.40	68.47
3.20	87.15	10.60	956.28	3.20	9.68	10.60	106.25	3.20	6.48	10.60	71.13
3.40	98.39	10.80	992.70	3.40	10.93	10.80	110.30	3.40	7.32	10.80	73.84
3.60	110.30	11.00	1029.81	3.60	12.26	11.00	114.42	3.60	8.20	11.00	76.60
3.80	122.90	11.20	1067.60	3.80	13.66	11.20	118.62	3.80	9.14	11.20	79.41
4.00	136.17	11.40	1106.07	4.00	15.13	11.40	122.90	4.00	10.13	11.40	82.27
4.20	150.13	11.60	1145.22	4.20	16.68	11.60	127.25	4.20	11.17	11.60	85.18
4.40	164.77	11.80	1185.05	4.40	18.31	11.80	131.67	4.40	12.26	11.80	88.14
4.60	180.09	12.00	1225.56	4.60	20.01	12.00	136.17	4.60	13.40	12.00	91.16
4.80	196.09	12.20	1266.75	4.80	21.79	12.20	140.75	4.80	14.59	12.20	94.22
5.00	212.77	12.40	1308.62	5.00	23.64	12.40	145.40	5.00	15.83	12.40	97.34
5.20	230.13	12.60	1351.18	5.20	25.57	12.60	150.13	5.20	17.12	12.60	100.50
5.40	248.18	12.80	1394.41	5.40	27.58	12.80	154.93	5.40	18.46	12.80	103.72
5.60	266.90	13.00	1438.33	5.60	29.66	13.00	159.81	5.60	19.85	13.00	106.98
5.80	286.30	13.20	1482.93	5.80	31.81	13.20	164.77	5.80	21.30	13.20	110.30
6.00	306.39	13.40	1528.20	6.00	34.04	13.40	169.80	6.00	22.79	13.40	113.67
6.20	327.16	13.60	1574.16	6.20	36.35	13.60	174.91	6.20	24.33	13.60	117.09
6.40	348.60	13.80	1620.80	6.40	38.73	13.80	180.09	6.40	25.93	13.80	120.56
6.60	370.73	14.00	1668.12	6.60	41.19	14.00	185.35	6.60	27.58	14.00	124.08
6.80	393.54	14.20	1716.12	6.80	43.73	14.20	190.68	6.80	29.27	14.20	127.65
7.00	417.03	14.40	1764.80	7.00	46.34	14.40	196.09	7.00	31.02	14.40	131.27
7.20	441.20	14.60	1814.17	7.20	49.02	14.60	201.57	7.20	32.82	14.60	134.94
7.40	466.05	14.80	1864.21	7.40	51.78	14.80	207.13	7.40	34.67	14.80	138.66
7.60	491.59	15.00	1914.94	7.60	54.62	15.00	212.77	7.60	36.56	15.00	142.43
7.80	517.80	15.20	1966.34	7.80	57.53	15.20	218.48	7.80	38.51	15.20	146.26
8.00	544.69	15.40	2018.43	8.00	60.52	15.40	224.27	8.00	40.51	15.40	150.13
8.20	572.27	15.60	2071.19	8.20	63.59	15.60	230.13	8.20	42.57	15.60	154.06
8.40	600.52	15.80	2124.64	8.40	66.72	15.80	236.07	8.40	44.67	15.80	158.03
8.60	629.46	15.964	2168.98	8.60	69.94	15.964	241.00	8.60	46.82	15.964	161.33
8.80	659.08			8.80	73.23			8.80	49.02		

THE INDOOR UNIT INSTALLATION

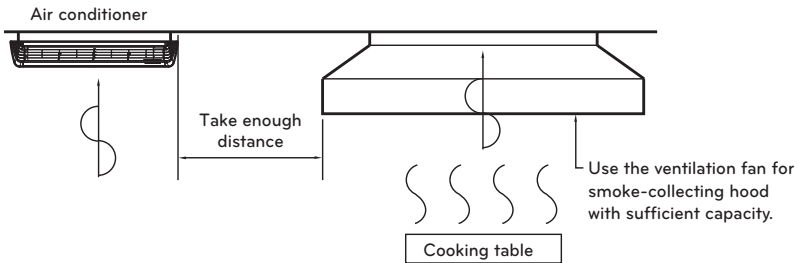

CAUTION

- This air-conditioner uses a drain pump.
- Install the unit horizontally using a level gauge.
- During the installation, care should be taken not to damage electric wires.
- Select and mark the position for fixing bolts and piping hole.
- Decide the position for fixing bolts slightly tilted to the drain direction after considering the direction of drain hose.
- Drill the hole for anchor bolt on the ceiling or wall.

NOTE

Avoid the following installation location.

- Such places as restaurants and kitchen where considerable amount of oil steam and flour is generated. These may cause heat exchange efficiency reduction, or water drops, drain pump mal-function.

In these cases, take the following actions;

- Make sure that ventilation fan is enough to cover all noxious gases from this place.
- Ensure enough distance from the cooking room to install the air conditioner in such a place where it may not suck oily steam.
- Avoid installing air conditioner in such places where cooking oil or iron powder is generated.
- Avoid places where inflammable gas is generated.
- Avoid place where noxious gas is generated.
- Avoid places near high frequency generators.

Install the unit leaning to a drainage hole side as a figure for easy water drainage.

Position of suspension Bolt

- Apply a joint-canvas between the unit and duct to absorb unnecessary vibration.
- Apply a filter Accessory at air return hole.

[Ceiling Concealed Duct – Low Static]

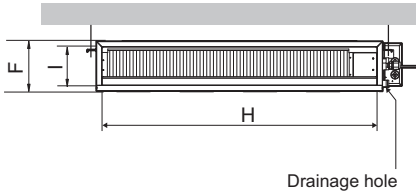
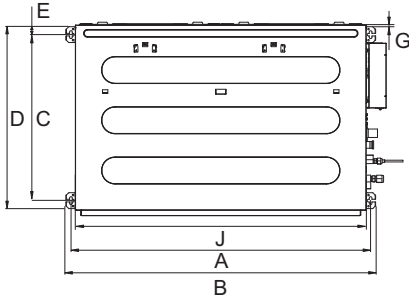

(Unit: mm)

Dimension		A	B	C	D	E	F	G	H	I	J
Low Static	L1	733	772	628	700	36	190	20	660	155	700
	L2	933	972	628	700	36	190	20	860	155	900
	L3	1133	1172	628	700	36	190	20	1060	155	1100
	L4	733	772	338	460	36	190	20	660	148	700
	L5	933	972	338	460	36	190	20	860	148	900
	L6	1133	1172	338	460	36	190	20	1060	148	1100

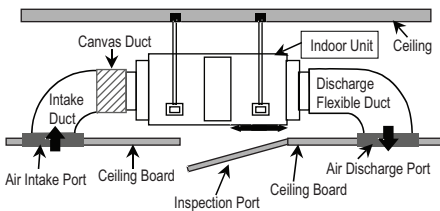

[Ceiling Concealed Duct – Mid Static]

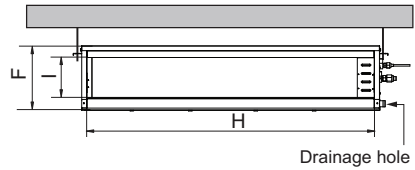
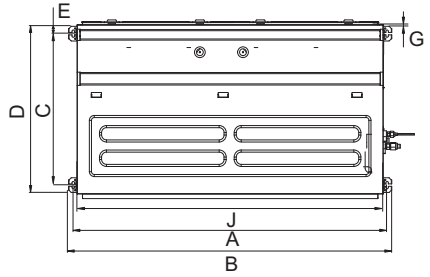

(Unit: mm)

Dimension		A	B	C	D	E	F	G	H	I	J
Mid Static	M1	933.4	971.6	619.2	700	30	270	15.2	858	201.4	900
	M2	1283.4	321.6	619.2	689.6	30	270	15.2	1208	201.4	1250
	M3	1283.4	321.6	619.2	689.6	30	360	15.2	1208	291.4	1250

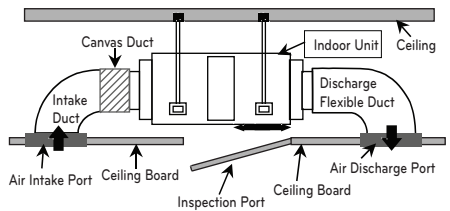

- A place where the unit will be leveled and that can support the weight of the unit.
- A place where the unit can withstand its vibration.
- A place where service can be easily performed.

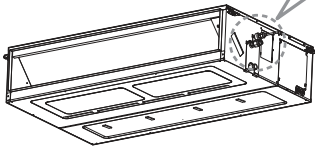
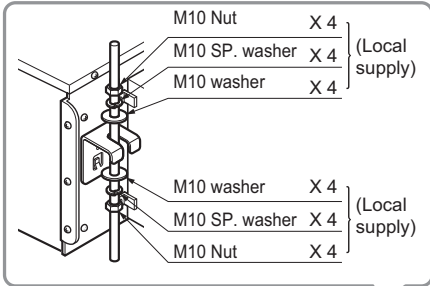

- Select and mark the position for fixing bolts.
- Drill the hole for set anchor on the face of ceiling.

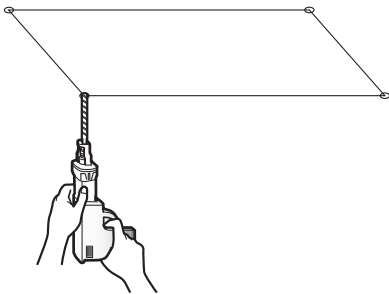

- Insert the set anchor and washer onto the suspension bolts for locking the suspension bolts on the ceiling.
- Mount the suspension bolts to the set anchor firmly.
- Secure the installation plates onto the suspension bolts (adjust level roughly) using nuts, washers and spring washers.

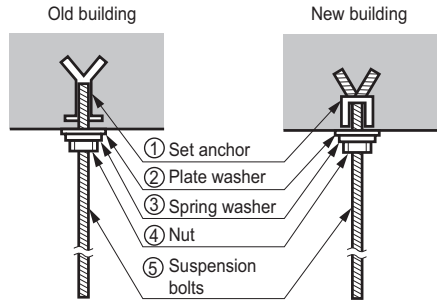

Local supply

- ① Set anchor
- ② Plate washer - M10
- ③ Spring washer - M10
- ④ Nut - W3/8 or M10
- ⑤ Suspension bolt - W3/8 or M10

! CAUTION

- Tighten the nut and bolt to prevent unit falling.

! CAUTION

1. Install declination of the indoor unit is very important for the drain of the duct type air conditioner.
2. Minimum thickness of the insulation for the connecting pipe shall be 10 mm.

Front of view

- The unit must be horizontal or declined to the drain hose connected when finished installation.

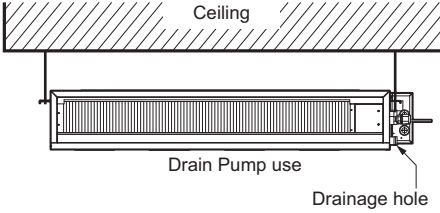

[Ceiling Cassette]

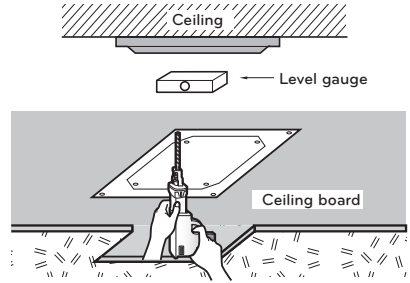

Ceiling Concealed Duct – Low static

- The unit must be declined to the drain hose connected when finished installation.

CORRECT

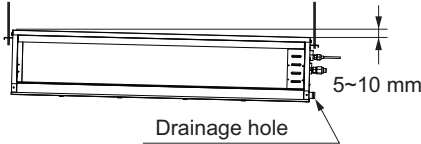

INCORRECT

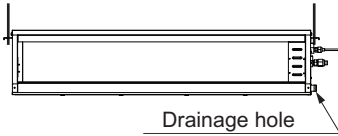

Ceiling Concealed Duct – Mid static

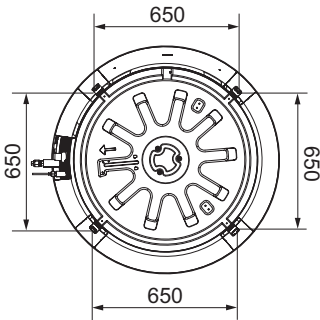

TY Chassis

(Unit: mm)

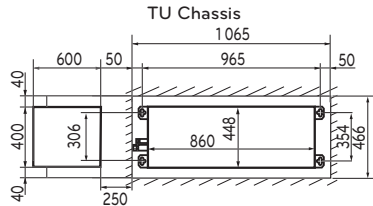
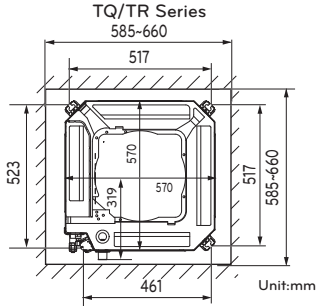
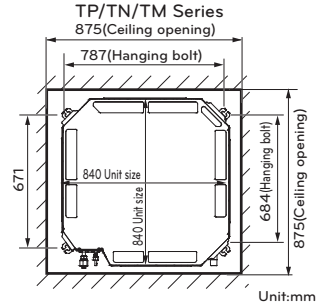

Fixing Installation Plate

[Wall Mounted]

The wall you select should be strong and solid enough to prevent vibration

- 1 Mount the installation plate on the wall with type "A" screws. If mounting the unit on a concrete wall, use anchor bolts.
 - Mount the installation plate horizontally by aligning the centerline using Horizontal meter.

- 2 Measure the wall and mark the centerline. It is also important to use caution concerning the location of the installation plate. Routing of the wiring to power outlets is through the walls typically. Drilling the hole through the wall for piping connections must be done safely.

SK/SJ Chassis

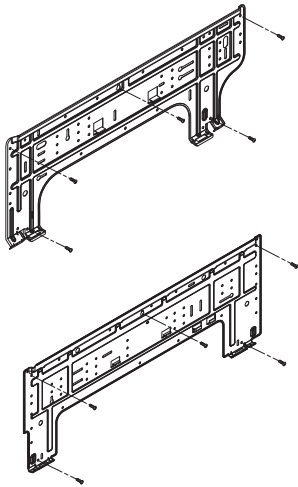

SK/SJ Chassis

(Unit: mm)

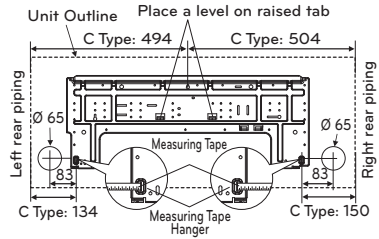
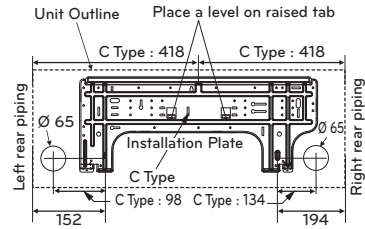

SR Chassis

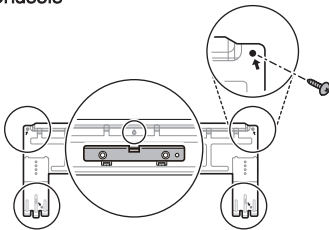

SR Chassis

(Unit: mm)

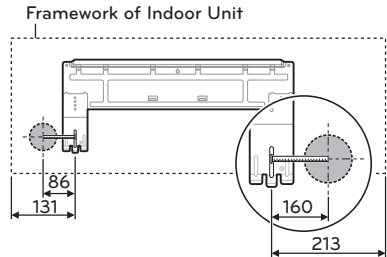

Connecting the Piping

- 1 Pull the cover at the bottom of the indoor unit. Pull the cover ① → ②.
- 2 Remove the cover from the indoor unit.

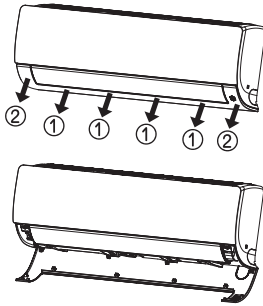

- 3 Pull back the tubing holder.
- 4 Remove pipe port cover and positioning the tubing

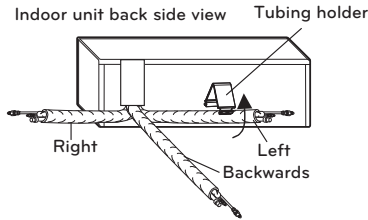

* The feature can be changed according to type of model.

Assembly of chassis cover

- 1 Insert 4 hooks of the chassis cover into gap of the chassis certainly.

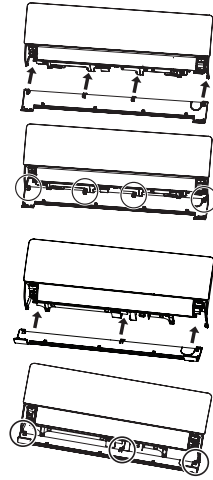

- 2 Push the 6 point hook to assemble chassis cover. Push the chassis cover ① → ②.

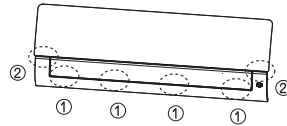

NOTE

To protect the chassis cover bended, assembly chassis cover correctly.

Good case

- Press on the tubing cover and unfold the tubing to downward slowly. And then bend to the left side slowly.

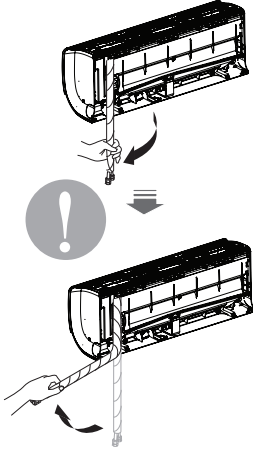

* The feature can be changed according to type of model.

Bad case

- Following bending case from right to left directly may cause damage to the tubing.

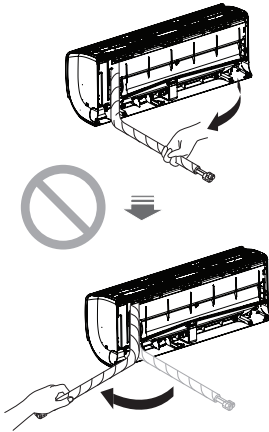

* The feature can be changed according to type of model.

NOTE

Installation Information. For right piping. Follow the instruction above.

Installation of Indoor Unit

- 1 Hook the indoor unit onto the upper portion of the installation plate.(engage the three hooks at the top of the indoor unit with the upper edge of the installation plate) Ensure that the hooks are properly seated on the installation plate by moving it left and right

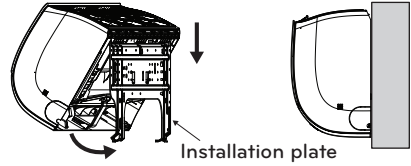

- 2 Unlock the tubing holder from the chassis and mount between the chassis and installation plate in order to separate the bottom side of the indoor unit from the wall.

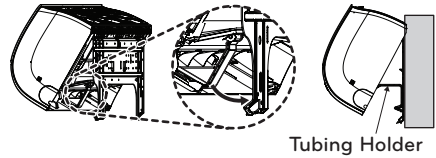

* The feature can be changed according to the type of model.

Piping

1 Insert the connecting cable through the bottom side of indoor unit and connect the cable (You can see detail contents in 'Connecting the cables' section)

<Left side piping>

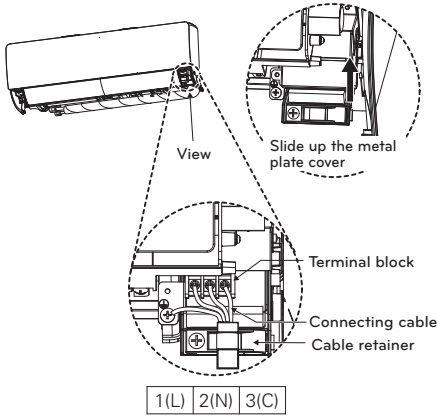

<Left side piping>

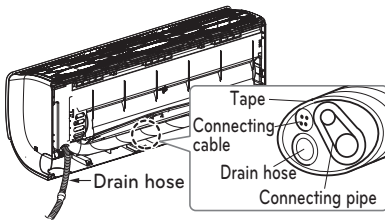

<Right side piping>

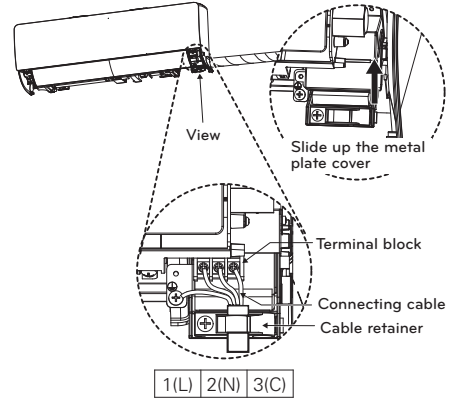

<Right side piping>

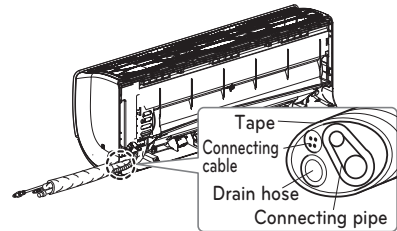

- 2 Secure the cable onto the control board with the cable retainer.
- 3 Tape the tubing pipe, drain hose and the connection cable. Be sure that the drain hose is located at the lowest side of the bundle. Locating at the upper side can cause overflow from the drain pan through the inside of the unit.

Finishing the indoor unit installation

- 1 Mount the tubing holder in the original position.
- 2 Ensure that the hooks are properly seated on the installation plate by moving it left and right.
- 3 Press the lower left and right sides of the unit against the installation plate until the hooks engage into their slots (clicking sound).
- 4 Finish the assembly by screwing the unit to the installation plate by using two pieces of type "C" screws. And assemble a chassis cover.

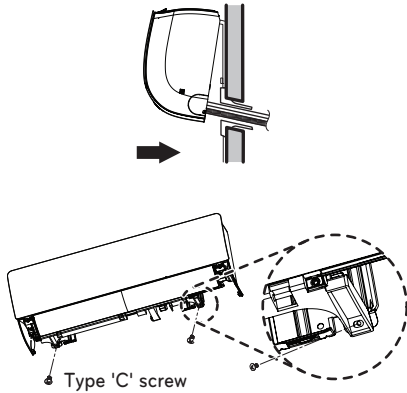

* The feature can be changed according to type of model.

⚠ CAUTION

The indoor unit can be dropped from the wall, the indoor unit is not screwed correct position on the install plate.

To avoid the gap between the indoor unit and wall, screw the indoor unit to the install plate correctly.

[Console]

Preparation / Removing front panel

- 1 Open the front grille by pulling forward
- 2 Then pull out the link of grille from groove in front panel.
- 3 Then pull out 2 hinges of grille from grooves in front panel.
- 4 Then remove 4 screws, dismount the front panel while pulling it forward.

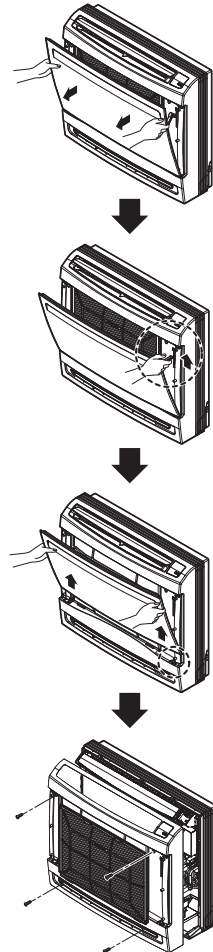

Preparation / For Moldings , Side Piping, and Concealed Installation

For Moldings

- 1 Remove the slit portions on the Rear Panel.

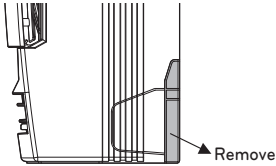

For Concealed Installation

- 1 Remove the 6 screws.
- 2 Remove the Upper Deco cover.
- 3 Remove the Side Deco covers.

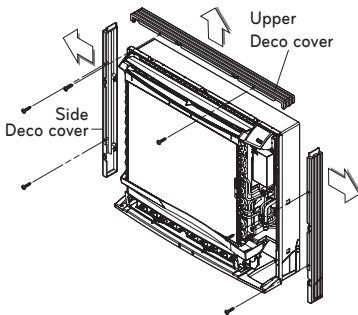

For Side Piping

- 1 Remove the Deco Covers.
- 2 Remove the slit portions
- 3 Assemble the Deco Covers.

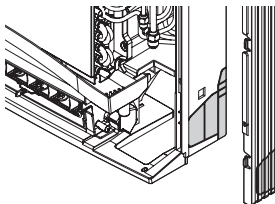

Refrigerant Piping

- 1 The location of hole is different depending on which side of the pipe is taken out.
- 2 Drill a hole ($\varnothing 70$ mm) in the point indicated by \otimes symbol in the illustration as below

(Unit: mm)

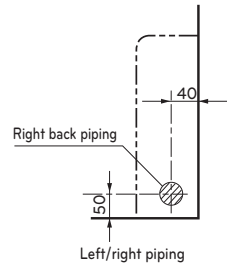
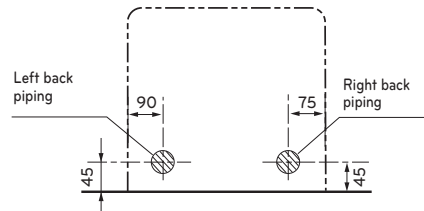
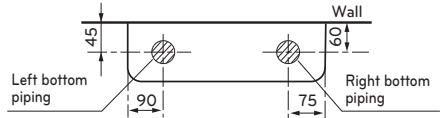

NOTE

The suggested shortest pipe length is 5 m, in order to avoid noise from the outdoor unit and vibration.

- 1 The Outer diameter of Drain Hose (which is supplied with indoor unit) is 17 mm at connecting end, 600 mm long.
- 2 Use commercial rigid PVC pipe for extension.
- 3 Insulate the indoor drain pipe with 10 mm or more of insulation material to prevent condensation.

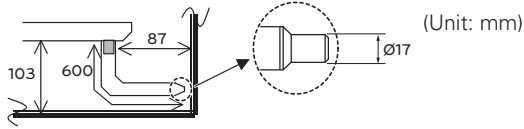

NOTE

The drain pipe should be inclined downward so that water will flow smoothly without any accumulation.

Installing Indoor unit

Installation on the Floor

- 1 Fix up using 6 screws for floor installation.

(Unit: mm)

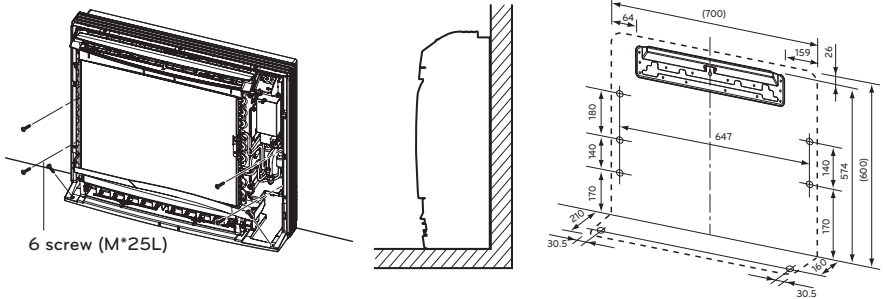

Installation on the Wall

- 1 Fix up the installation plate using 5 screws and the indoor unit using 4 screws.
- 2 The installation plate should be fixed on a wall which can support the weight of the indoor unit.

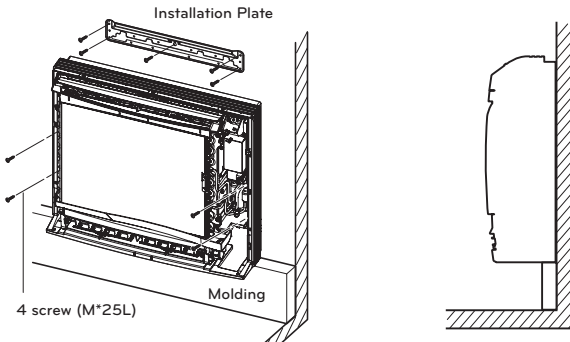

Half concealed installation.

1 Make a wall hole of the size shown Fig-1.

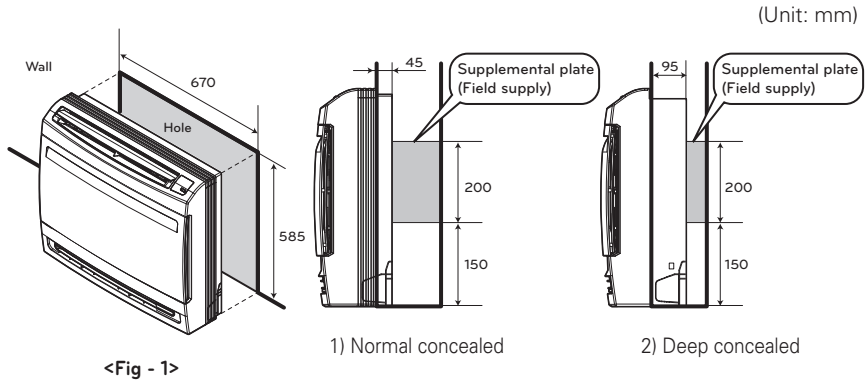

2 Installation of supplemental plate for attaching main unit.

- The rear of the unit can be fixed with screws at the points shown in the Fig-2. Be sure to install the supplemental plate in accordance with the depth of the inner wall.

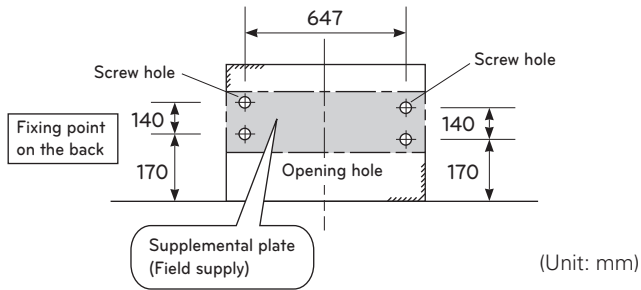

3 Piping Hole

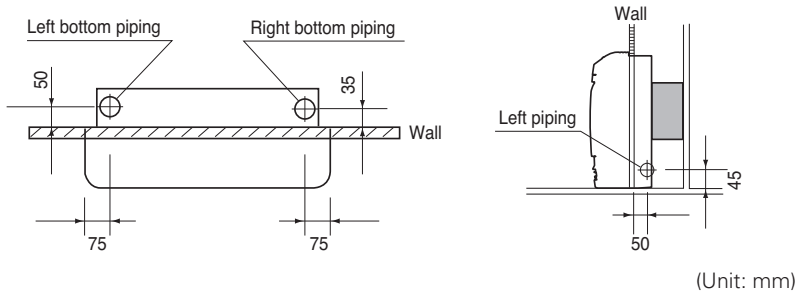

- 4 Remove the Deco Covers and Fixing Indoor Unit
- 1) Remove the Deco Covers.
 - 2) Insert the Indoor Unit to the Wall hole.
 - 3) Secure using 6 screws. (shown in the illustration)

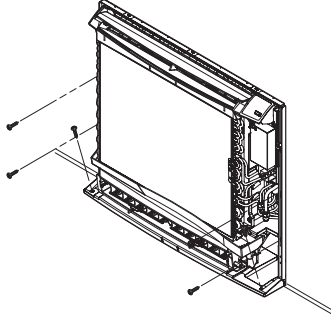
**NOTE**

Check the horizon of Indoor unit with the wall. Please use the Leveler on the drain pan guide.

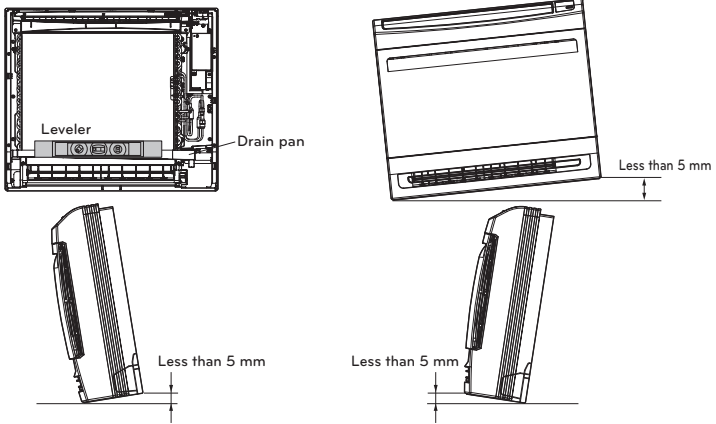

Connecting the Piping

When you connect the refrigerant pipe, it is easier that you connect the gas pipe first.

- 1 Hold up the Sensor Link.
- 2 Separate the Pipe Bracket (2 screws)
- 3 Connect the refrigerant pipe.
- 4 Assemble the Pipe Bracket (2 screws)
- 5 Put down the Sensor Link

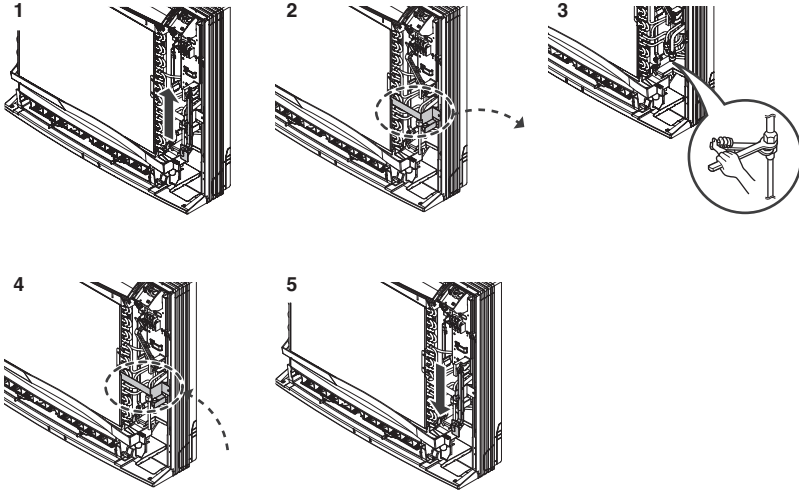

- 6 After connecting, check the pipe arrangement as per illustration.
- 7 The piping can be arranged in six ways as shown in the illustration below.

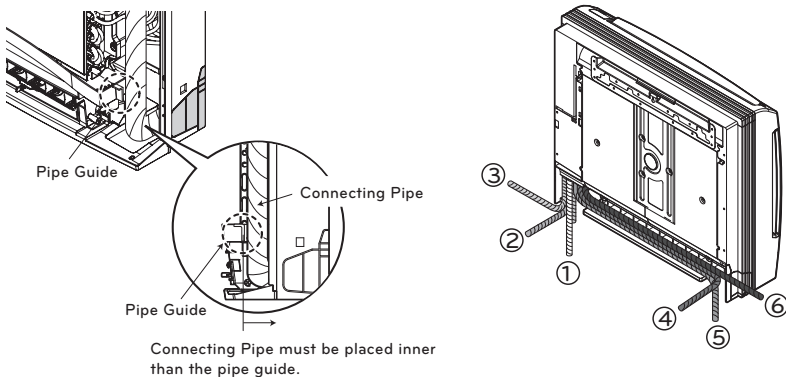

Open side-cover

[Ceiling suspended type]

Step 1

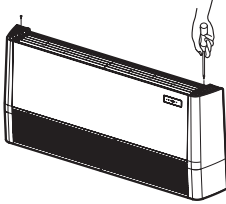

- Remove two screws from side-cover.

Step 2

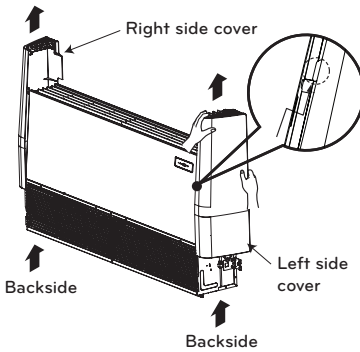

- Unlock side-cover from side-panel slightly (Tap the side-cover with your palm on the backside)

Step 3

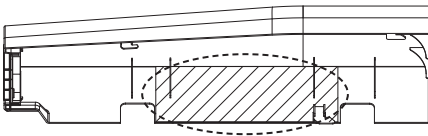

- Remove paper bracket from side-cover.

Step 4

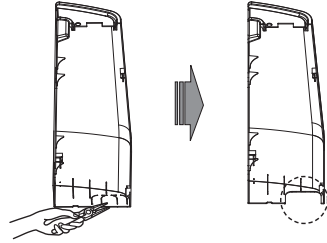

- Knock out the pipe hole from the left sidecover with nipper/plier.

CAUTION

Hold the side-cover with other hand while tapping to prevent it to fall down.

Mounting the anchor nut and bolt

- Prepare 4 suspension bolts. (Each bolts length should be same.)
- Measure and mark the position for the Suspension bolts and the piping hole.
- Drill the hole for anchor nut on the ceiling.
- Insert the nuts and washer onto the suspension bolts for locking the suspension bolts on the ceiling.
- Mount the suspension bolts to the anchornuts firmly.
- Secure the hangers onto the Suspension bolts (adjust level roughly.) using nuts, washers and spring washers.
- Adjust a level with a level gauge on the direction of left-right, back-forth by adjusting suspension bolts.
- Adjust a level on the direction of top-bottom by adjusting suspension bolts. Then the unit will be declined to the bottomside so as to drain well.

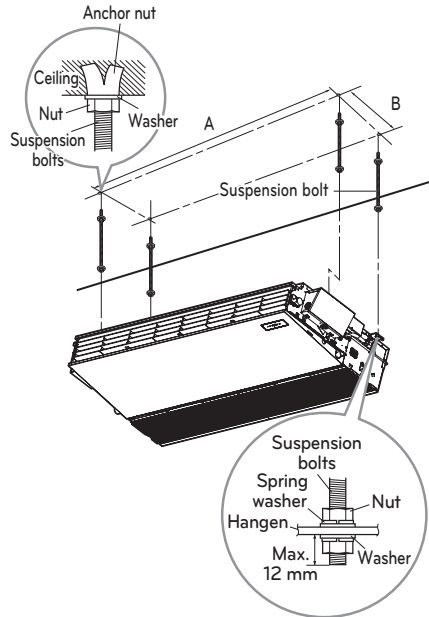

(Unit : mm)

Model (kBtu/h)	A	B
18 k/24 k	1 018	355
36 k/42 k/48 k/60 k	1 418	

! CAUTION

- Installation information for declination
- Install declination of the indoor unit is very important for the drain of the convertible type air conditioner.
 - Minimum thickness of the insulation for the connecting pipe shall be 10 mm.
 - If the Installation Plates are fixed to horizontal line, the indoor unit after installing will be declined to the bottomside.

Front of view

- The unit must be horizontal or inclined at angle.
- The inclination should be less than or equal to 1° or in between 10 to 20 mm inclined in drain direction as shown in fig.

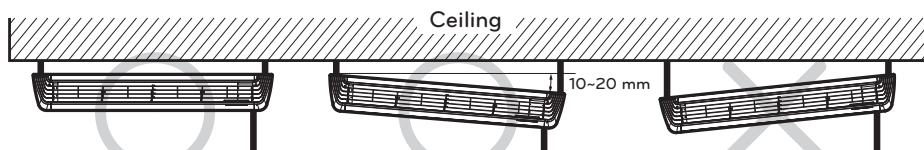
**Side of view**

- The unit must be inclined to the bottomside of the unit when finished installation.

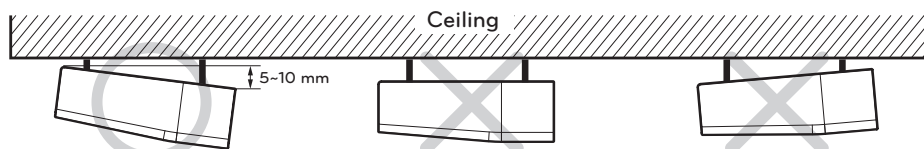

Indoor Unit Drain Piping

[Ceiling Concealed Duct / Cassette]

- Drain piping must have down-slope (1/50 to 1/100): be sure not to provide up-and-down slope to prevent reversal flow.
- During drain piping connection, be careful not to exert extra force on the drain port on the indoor unit.
- The outside diameter of the drain connection on the indoor unit is 32 mm.

Piping material: Polyvinyl chloride pipe VP-25 and pipe fittings

- Be sure to execute heat insulation on the drain piping.
- Install the drain raising pipes at a right angle to the indoor unit and no more than 300 mm from the unit.

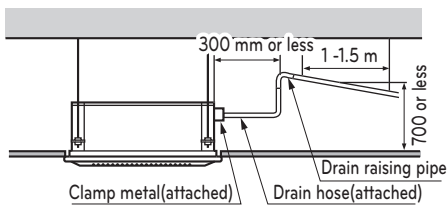
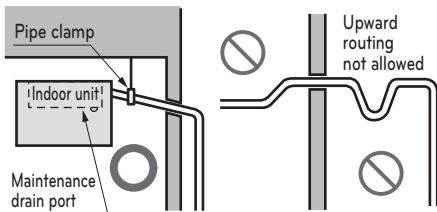

Heat insulation material: Polyethylene foam with thickness more than 8 mm.

[Type : Round]

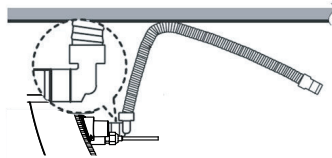
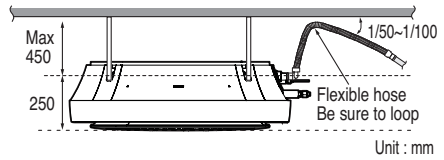

1. Connect the elbow connector to the product facing upwards.

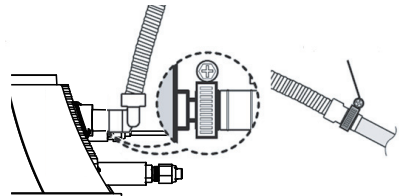

2. Place the bolt of the clamp joint upwards to secure the connector.

Drain test

The air conditioner uses a drain pump to drain water.

Use the following procedure to test the drain pump operation:

- Connect the main drain pipe to the exterior and leave it provisionally until the test comes to an end.
- Feed water to the flexible drain hose and check the piping for leakage.
- Be sure to check the drain pump for normal operating and noise when electrical wiring is complete.
- When the test is complete, connect the flexible drain hose to the drain port on the indoor unit.

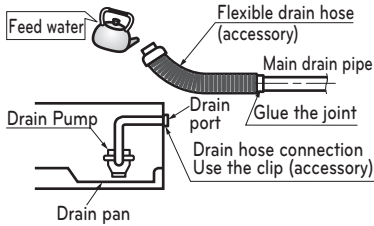

CAUTION

The supplied flexible drain hose should not be curved, neither screwed. The curved or screwed hose may cause a leakage of water.

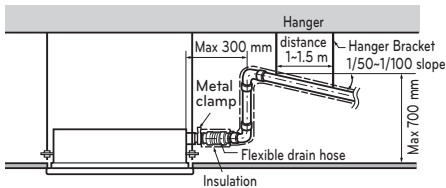

[Wall Mounted]

To check the drainage

- 1 Pour a glass of water on the evaporator.
- 2 Ensure the water flows through the drain hose of the indoor unit without any leakage and goes out the drain exit.

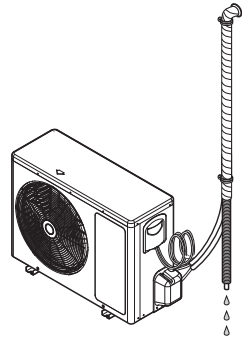
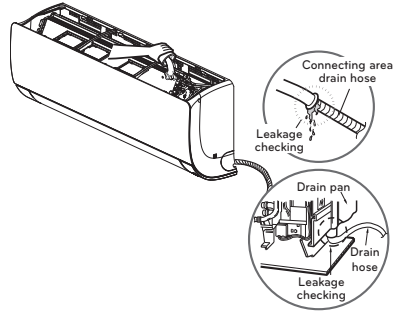

* The feature can be changed according to type of model.

Drain piping

- 1 The drain hose should point downward for easy drain flow.

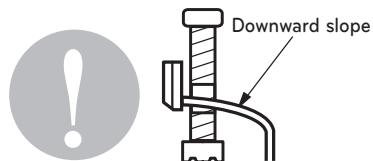

- 2 Do not make drain piping like the following.

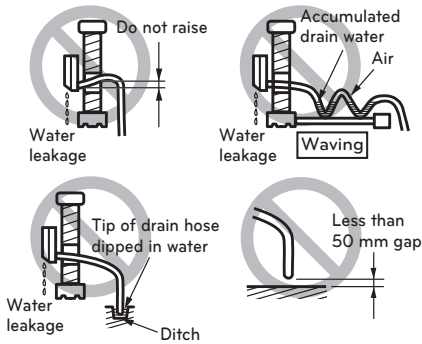

* The feature can be changed according to type of model.

Evaluation of the performance

Operate the unit for 15~20 minutes, then check the system refrigerant charge:

- 1 Measure the pressure of the gas side service valve.
- 2 Measure the air temperature from inlet and outlet of air conditioner.
- 3 Ensure the difference between the inlet and outlet temperature is more than 8 °C.
- 4 For reference; the gas side pressure at optimum condition is shown on table (cooling)

The air conditioner is now ready to use.

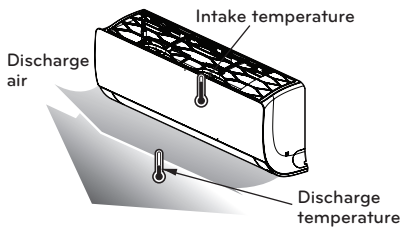

* The feature can be changed according a type of model.

[Ceiling suspended type]

- Drain piping must have down-slope (1/50 to 1/100): be sure not to provide up - and - down slope to prevent reversal flow.
- During drain piping connection, be careful not to exert extra force on the drain port on the indoor unit.
- Remove the rubber stopple before connecting drain hose.
- Hook on the bracket after connecting the drain hose as below.

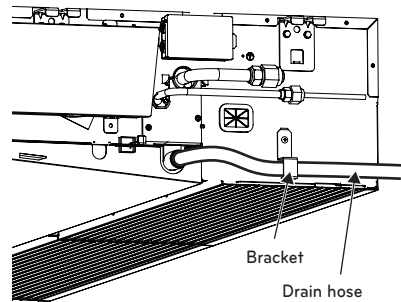

Drain test

Use the following procedure to test the drain pump operation:

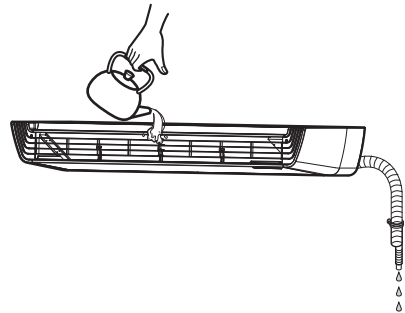

- Set the air direction louvers up - and - down to the position (horizontally) by hand.
- Pour a glass of water on the evaporator using a kettle.
- Ensure the water flows through the drain hose of the indoor unit without any leakage and goes out the drain exit.

HEAT INSULATION

- Use the heat insulation material for the refrigerant piping which has an excellent heat-resistance (over 120 °C).

- Precautions in high humidity circumstance:

This air conditioner has been tested according to the "KS Standard Conditions with Mist" and confirmed that there is not any default. However, if it is operated for a long time in high humid atmosphere (dew point temperature: more than 23 °C), water drops are liable to fall. In this case, add heat insulation material according to the following procedure:

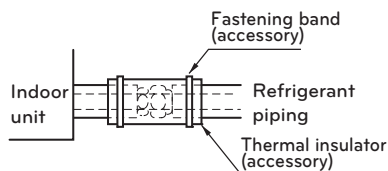

- Heat insulation material to be prepared... Adiabatic EPDM or NBR with thickness 10 to 20 mm.

- Stick glass wool on all air conditioners that are located in ceiling atmosphere.

applies to	Insulation material standard (mm) (besides normal conditions for residential use)		Insulation material standard (mm) - residential		Insulation material standard (mm) (unfavorable conditions)
			If installed in an air-conditioned place (CASE 1) (ex: bedroom, living room, etc.)	If installed in a non-air conditioned place (CASE 2) (ex: hallway, outdoors, etc.)	
	Refrigerant piping dimensions (mm)	EPDM	EPDM	EPDM	EPDM
Gas piping	6.35	19	13	19	19
	9.52	19	13	19	25
	12.7	19	13	19	25
	15.88	19	13	19	25
	19.05	19	13	19	25
	22.22	19	13	19	32
	25.40	19	19	19	32
	28.58	19	19	19	32
	31.75	19	19	19	32
	38.1	25	19	25	32
44.45	25	19	25	32	
Liquid piping	6.35	9	9	9	9
	9.52				
	12.7~44.45	13	13	13	13

• Normal conditions: Temperature of 30 °C, relative humidity of 85 %

• Unfavorable conditions: Temperature of 30 °C, relative humidity of 90 % (humid places such as bathrooms, swimming pools, etc.: air supply and exhaust fan installation)

Wiring Connection

- * The feature can be changed according a type of model.
- * Pipes and wires should be purchased separately for installation of the product.
- Open the control box cover and connect the Remote controller cord and Indoor power wires.
- Remove the control box cover for electrical connection between the indoor and outdoor unit. (Remove screws ①)
- Use the cord clamper to fix the cord.

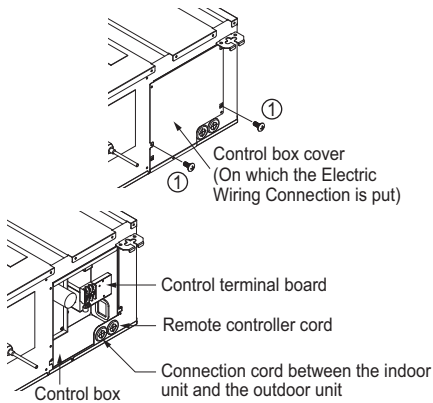

Ceiling Concealed Duct – Low Static, Mid Static

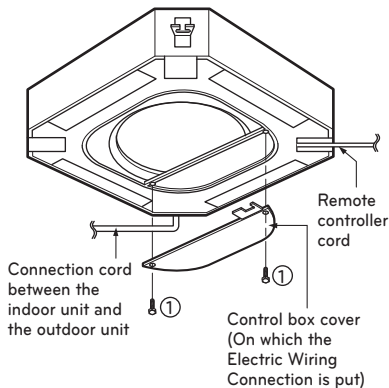

Wiring Connection for Round Type

- Connect the wires to the terminals on the control box individually according to the outdoor unit connection.
- Ensure that the color of the wires of outdoor unit and the terminal No. are the same as those of indoor unit respectively.

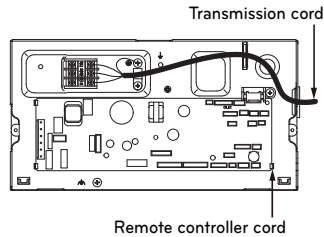
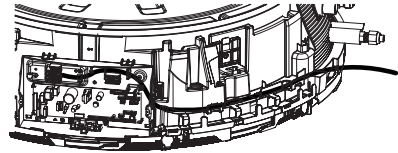

- When connecting the wired remote controller, remove the deco panel and pull into the lower hole of the control box.

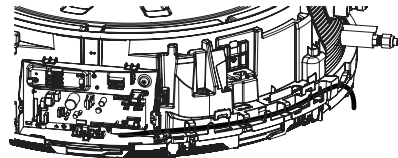

Wired remote controller connector

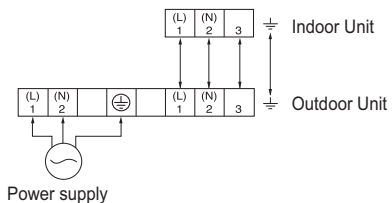

Connect the cable to the indoor unit by connecting the wires to the terminals on the control board individually according to the outdoor unit connection. (Ensure that the color of the wires of the outdoor unit and the terminal No. are the same as those of the indoor unit.)

Insert the connecting cable through the bottom side of indoor unit and connect the cable.

- (1) Open the Decor
- (2) Unscrew the screw of C/Box
- (3) Slide up the Metal Plate Cover
- (4) Connect the connecting cable
- (5) After complete connect the cables, should assemble the Metal Plate Cover by screw.

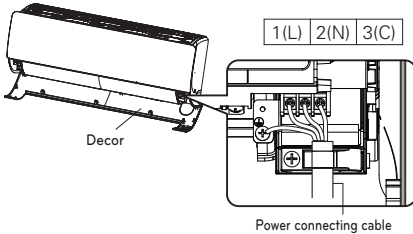
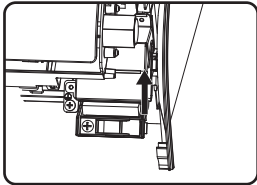

- 1 Loosen No 1, 2 screws of control box cover.
- 2 Connect the cable to the Terminal block as below diagram

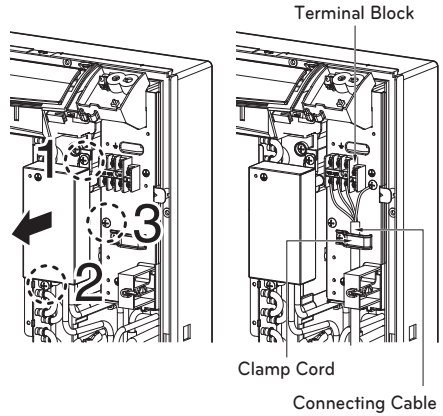
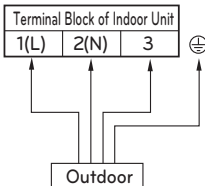

- 3 Secure the cable onto the Control panel with the Clamp cord.
- 4 If indoor unit's setting is needed, loosen No.3 screw and lift up the PCB. (option: usage of bottom vanes, limit angle of top vane)

DIP S/W	Description	S/W OFF	S/W ON
S/W 5	Install scene	Exposed	Half Concealed
S/W 7	Vane	Top+Bottom vane	Top vane only

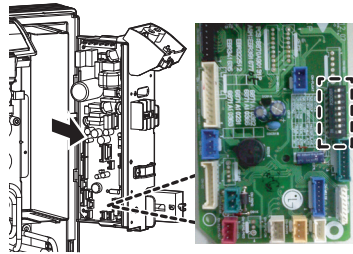

CAUTION

The Power cord connected to the unit should be selected according to the following specifications.

CAUTION

- The connecting cable connected to the indoor and outdoor unit should be complied with the following specifications (Rubber insulation, type H05RN-F approved by HAR or SAA).

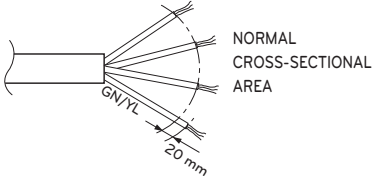

Rated current of appliance A.	Nominal cross-sectional area mm ²
≤ 0.2	Tinsel cord
> 0.2 and ≤ 3	0.5
> 3 and ≤ 6	0.75
> 6 and ≤ 10	1.0 (0.75)
> 10 and ≤ 16	1.5 (1.0)
> 16 and ≤ 25	2.5
> 25 and ≤ 32	4
> 32 and ≤ 40	6
> 40 and ≤ 63	10

NOTE For **supply cords** supplied with multi-phase appliances, the nominal cross-sectional area of the conductors is based on the maximum cross-sectional area of the conductors per phase at the **supply cord** connection to the appliance terminals.

- If the supply cord is damaged, it must be replaced by a special cord or assembly available from the manufacturer of its service agent.

CAUTION

- The circuit diagram is a subject to change without notice.
 - The earth wire should be longer than the common wires.
 - When installing, refer to the circuit diagram on the chassis cover.
 - Connect the wires firmly so that they may not be pulled out easily.
 - Connect the wires according to color codes, referring to the wiring diagram.
- The installation of a residual current device(RCD) having a rated residual operating current not exceeding 30 mA is advisable.

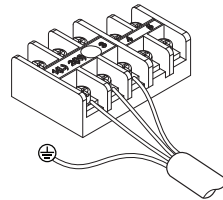
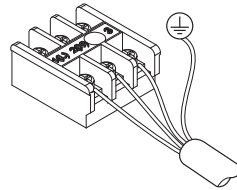

Precautions when laying power wiring

Use round pressure terminals for connections to the power terminal block.

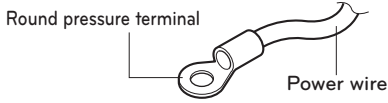

When none are available, follow the instructions below.

- Do not connect wiring of different thicknesses to the power terminal block. (Slack in the power wiring may cause abnormal heat.)
- When connecting wiring which is the same thickness, do as shown in the figure below.

Connect same thickness wiring to both sides.

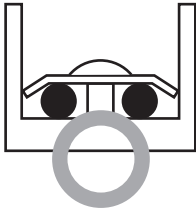

It is forbidden to connect two to one side.

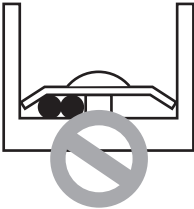

It is forbidden to connect wiring of different thicknesses.



- For wiring, use the designated power wire and connect firmly, then secure to prevent outside pressure being exerted on the terminal block.
- Use an appropriate screwdriver for tightening the terminal screws. A screwdriver with a small head will strip the head and make proper tightening impossible.
- Over-tightening the terminal screws may break them.

⚠ CAUTION

According to the confirmation of the above conditions, prepare the wiring as follows.

- 1 Never fail to have an individual power circuit specifically for the air conditioner. As for the method of wiring, be guided by the circuit diagram posted on the inside of control cover.
- 2 The screw which fasten the wiring in the casing of electrical fittings are liable to come loose from vibrations to which the unit is subjected during the course of transportation. Check them and make sure that they are all tightly fastened. (If they are loose, it could cause burn-out of the wires.)
- 3 Specification of power source.
- 4 Confirm that electrical capacity is sufficient.
- 5 See that the starting voltage is maintained at more than 90 percent of the rated voltage marked on the name plate.
- 6 Confirm that the cable thickness is as specified in the power source specification. (Particularly note the relation between cable length and thickness.)
- 7 Always install an earth leakage circuit breaker in a wet or moist area.
- 8 The following would be caused by voltage drop.
 - Vibration of a magnetic switch, which will damage the contact point, fuse breaking, disturbance of the normal function of the overload.
- 9 The means for disconnection from a power supply shall be incorporated in the fixed wiring and have an air gap contact separation of at least 3 mm in each active(phase) conductors.
- 10 Open the terminal cover block before connecting the indoor side wire.

Electrical Wiring

- 1 All wiring must comply with LOCAL REGULATIONS.
- 2 Select a power source that is capable of supplying the current required by the air conditioner.
- 3 Feed the power source to the unit via a distribution switch board designed for this purpose.
- 4 The terminal screws inside the control box may be loose due to vibration during transport. Check the screws for loose connection. (Running the air conditioner with loose connection can overload and damage electrical components.)
- 5 Always ground the air conditioner with a grounding wire and connector to meet the LOCAL REGULATION.

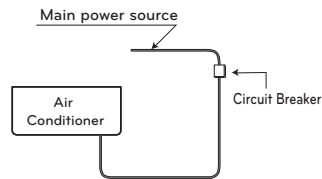

⚠ CAUTION

- The circuit diagram is not subject to change without notice.
- Be sure to connect wires according to the wiring diagram.
- Connect the wires firmly, so that not to be pulled out easily.
- Connect the wires according to color codes by referring the wiring diagram.

Flaring Work

Main cause for gas leakage is due to defect of flaring work. Carry out correct flaring work in the following procedure.

Cut the pipes and the cable

- 1 Use the piping kit accessory or the pipes purchased locally.
- 2 Measure the distance between the indoor and the outdoor unit.
- 3 Cut the pipes a little longer than measured distance.
- 4 Cut the cable 1.5 m longer than the pipe length.

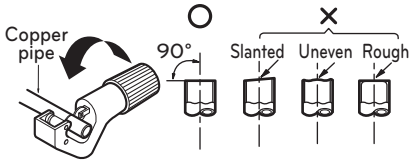

Burrs removal

1. Completely remove all burrs from the cut cross section of pipe/tube.
2. While removing burrs put the end of the copper tube/pipe in a downward direction while removing burrs location is also changed in order to avoid dropping burrs into the tubing.

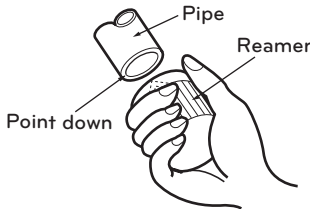

CAUTION

Copper in contact with refrigerants shall be oxygen-free or de-oxidized, for example Cu-DHP as specified in EN 12735-1 and EN 12735-2

Putting nut on

- Remove flare nuts attached to indoor and outdoor unit, then put them on pipe/tube having completed burr removal. (not possible to put them on after finishing flare work)

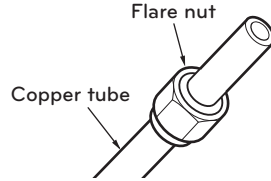

Flaring work

- 1 Firmly hold copper pipe in a bar with the dimension shown in below table table below.
- 2 Carry out flaring work with the flaring tool.

Pipe diameter Inch (mm)	A inch (mm)	
	Wing nut type	Clutch type
Ø 1/4 (Ø 6.35)	0.04~0.05 (1.1~1.3)	0~0.02 (0~0.5)
Ø 3/8 (Ø 9.52)	0.06~0.07 (1.5~1.7)	
Ø 1/2 (Ø 12.7)	0.06~0.07 (1.6~1.8)	
Ø 5/8 (Ø 15.88)	0.06~0.07 (1.6~1.8)	
Ø 3/4 (Ø 19.05)	0.07~0.08 (1.9~2.1)	

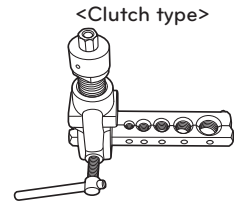
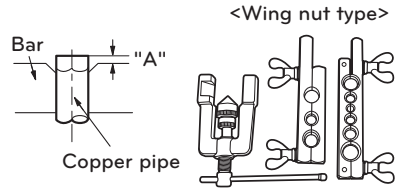

CAUTION

- The installation of pipe-work shall be kept to a minimum
- Flared joint shall be restricted to use with annealed pipe only, and to pipe sizes not exceeding a diameter of 20 mm outside diameter.

Check

- 1 Compare the flared work with the figure by.
- 2 If a flared section is defective, cut it off and do flaring work again.

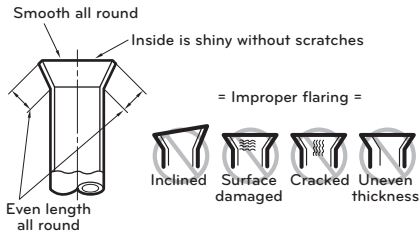

Connecting the installation pipe and drain hose to the indoor unit.

- 1 Align the center of the pipes and sufficiently tighten the flare nut by hand

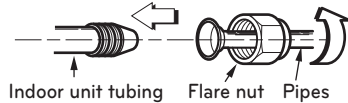

- 2 Tighten the flare nut with a wrench

Outside diameter		Torque
mm	inch	kgf·m
Ø 6.35	1/4	1.8~2.5
Ø 9.52	3/8	3.4~4.2
Ø 12.7	1/2	5.5~6.5
Ø 15.88	5/8	6.3~8.2
Ø 19.05	3/4	9.9~12.1

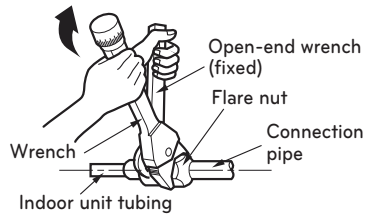

CAUTION

- When mechanical connectors are reused indoors, sealing parts shall be renewed.
- When flared joints are reused indoors, the flare part shall be re-fabricated.

- 3 When needed to extend the drain hose of indoor unit, assembly the drain pipe as shown on the drawing

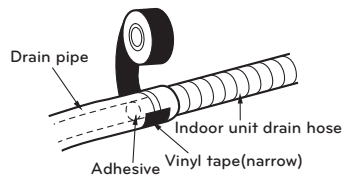

Wrap the insulation material around the connecting portion.

- 1 Overlap the connection pipe insulation material and the indoor unit pipe insulation material. Bind them together with vinyl tape so that there may be no gap.

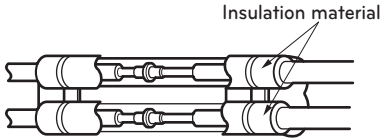

- 2 Set the tubing cutting line upward. Wrap the area which accommodates the rear piping housing section with vinyl tape.

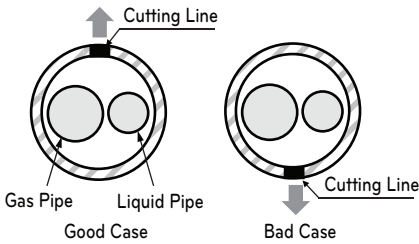

* Tubing cutting line have to be upward.

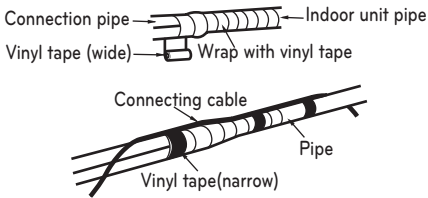

- 3 Bundle the piping and drain hose together by wrapping them with vinyl tape sufficient enough to cover where they fit into the rear piping housing section.

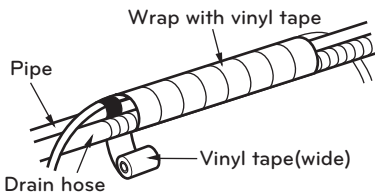

Test Running

- Check that all tubing and wiring are properly connected.
- Check that the gas and liquid side service valves are fully open.

Prepare remote controller

- 1 Remove the battery cover by pulling it according to the arrow direction.
- 2 Insert new batteries making sure that the (+) and (-) of battery are installed correctly.
- 3 Reattach the cover by pushing it back into position.

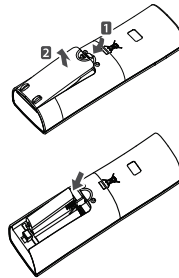

NOTE

- Use 2 AAA(1.5 V) batteries. Do not use rechargeable batteries.
- Remove the batteries from the remote controller if the system is not used for a long time

Test operation

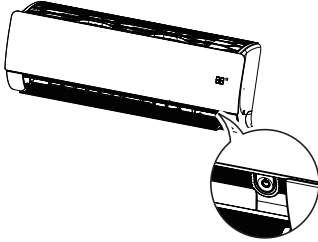

- If you press and hold the On/Off button for 3 – 5 seconds instead of 6 seconds, the unit will switch to the test operation.
- In the test operation, the unit blows out strong air for cooling for 18 minutes and then returns to the factory default settings.

NOTE

If the actual pressure is higher than shown, the system is most likely over-charged, and charge should be removed. If the actual pressure are lower than shown, the system is most likely undercharged, and charge should be added.

Pump Down

This is performed when the unit is relocated or the refrigerant circuit is serviced.

Pump Down means collecting all refrigerant into the outdoor unit without the loss of refrigerant.

NOTE

Be sure to perform Pump Down procedure in the cooling mode.

⚠ WARNING

It may cause explosion or injury.

After pump down, power must be turned off before removing the pipe. When operating this product without connecting the pipe, there will be high pressure inside the compressor due to the entry of air, possibly causing explosion or injury.

Pump Down Procedure

- Connect a low-pressure gauge manifold hose to the charge port on the gas side service valve.
- Open the gas side service valve halfway and purge the air in the manifold hose using the refrigerant.
- Close the liquid side service valve(all the way).
- Turn on the unit's operating switch and start the cooling operation.
- When the low-pressure gauge reading becomes 1 to 0.5 kg/cm² G(14.2 to 7.1 P.S.I.G.), fully close the gas side valve and then quickly turn off the unit. Now Pump Down procedure is completed, and all refrigerant is collected into the outdoor unit.

Heating Only Mode

Heating Only Mode switching function setup

- 1 Supply the power to the unit with no functions active.
- 2 Enter the Installer Code and set the code to 47.
- 3 Press  to select the code No.47 then, check if buzzer beeps.
- 4 Cut the power to the unit.
- 5 Turn back on the power to the unit after 30 seconds.

Heating Only Mode switching function disable setup



- 1 Supply the power to the unit with no functions active.
- 2 Enter the Installer Code and set the code to 48.
- 3 Press  to select the code No.48 then, check if buzzer beeps.
- 4 Cut the power to the unit.
- 5 Turn back on the power to the unit after 30 seconds.

* How to enter the installer mode

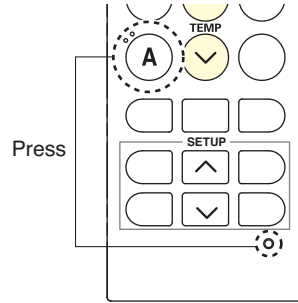
Press Reset Button and 'A' Button ()



* How to set the code

Set the code you want by pressing TEMP button () and press  .

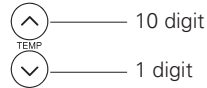

NOTE

- Once the function is set up, Cooling, Dehumidification Auto Change over cannot be used.
- Once the function is disable it will return to its normal state.
- Code cannot be entered when it is in operation mode. It must be OFF state to enter code.
- Even if able to enter code in ON state, it won't function if the code is not entered in OFF state.
- At Heating Only Mode, if the product gets turned off while the wireless remote control is set at other than heating / blowing, the product will not get turned back on. Turn off the product after the wireless remote control is set at heating / blowing and then turn back on.

SMART DIAGNOSIS (Optional)

Diagnosis of operating information

- 1 Enter the Installer Code and set the code to 57.
- 2 Click the "Receive" button on the main screen of LG AC Smart Diagnosis App on your smart phone.
- 3 Press  and hold your smart phone close to the indoor unit.
- 4 Receive the buzzer beeps from indoor unit with your smart phone.
- 5 The diagnosis of operating information will be displayed on the screen of your smart phone.

Diagnosis of error information



- 1 Enter the Installer Code and set the code to 58.
- 2 Click the "Receive" button on the main screen of LG AC Smart Diagnosis App on your smart phone.
- 3 Press  and hold your smart phone close to the indoor unit.
- 4 Receive the buzzer beeps from indoor unit with your smart phone.
- 5 The diagnosis of operating information will be displayed on the screen of your smart phone.

* How to enter the installer mode

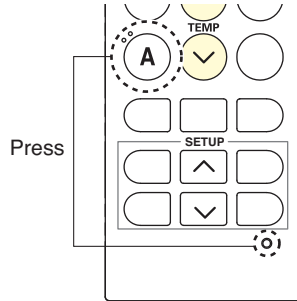
Press Reset Button and 'A' Button ()



* How to set the code

Set the code you want by pressing TEMP button () and press  .

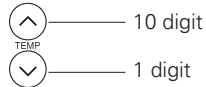

NOTE

- Be sure to keep ambient noise to a minimum or the smart phone may not correctly receive the buzzer beeps from the indoor unit.
- Initialization of diagnosis data may take approximately 1 minute after supplying the AC power .
- The code No. 57 is used for confirming the diagnosis data which is updated on while the indoor unit is operating
- The code No. 58 is used for confirming the diagnosis data which is the occurred time of Error Code.

Manual the decor, air filter Assembly & Disassembly

Disassemble the decor

- 1 Turn off the power and unplug the power cord.
- 2 Pull the decor at the bottom of the indoor unit.



- 3 Remove the decor from the indoor unit.



Assemble the decor

- 1 Turn off the power and unplug the power cord.
- 2 Insert 3 or 4 hooks of the decor into gap of the indoor unit certainly.

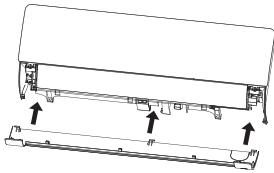

- 3 Push the nooks to assemble the decor.

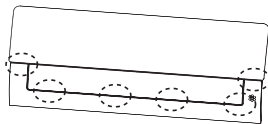

CAUTION

The air filter can be broken when it is bended.

Disassemble the air filter

- 1 Turn off the power and unplug the power cord.
- 2 Hold the knob of the air filter, Lift it up slightly.



- 3 Hold the knob of the air filter, lift it up slightly and remove it from the unit.



Assemble the air filter

- 1 Turn off the power and unplug the power cord.
- 2 Insert the hooks of the air filter into the front grille.

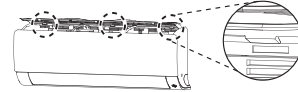

- 3 Push down hooks to assemble the air filter.

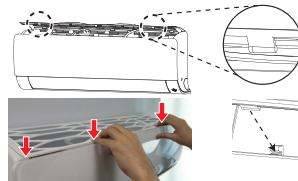

- 4 Check side of the front grille for the air filter assembled correctly.



NOTE

If the air filter is not assembled correctly, Dust and other substance come into the indoor unit. If look at the indoor unit from higher than it, can assemble the air filter easily.

Precautions about installation in regions with extreme snowfall and cold temperatures

To ensure the outdoor unit operates properly, certain measures are required in locations where there is a possibility of heavy snowfall or severe wind chill or cold :

- 1 Prepare for severe winter wind chills and heavy snowfall, even in areas of the country where these are unusual phenomena.
- 2 Position the outdoor unit so that its airflow fans are not buried by direct, heavy snowfall. If snow piles up and blocks the airflow, the system may malfunction.
- 3 Remove any snow that has accumulated 100 mm or more on the top of the outdoor unit.
- 4 Place the outdoor unit on a raised platform at least 500 mm higher than the average annual snowfall for the area. If the frame width is wider than the outdoor unit, snow may accumulate.
- 5 Install a snow protection hood.
- 6 To prevent snow and heavy rain from entering the outdoor unit, install the suction and discharge ducts facing away from direct winds.
- 7 Additionally, the following conditions should be taken into consideration when the unit operates in defrost mode:
 - If the outdoor unit is installed in a highly humid environment (near an ocean, lake, etc.), ensure that the site is well-ventilated and has a lot of natural light. (Example: Install on a rooftop.)

INSTALLATION OF DECORATIVE PANEL(ACESSORY)

The decorative panel has its installation direction. Before installing the decorative panel, always remove the paper template.

- 1 Remove the packing and take out air inlet grille from front panel.

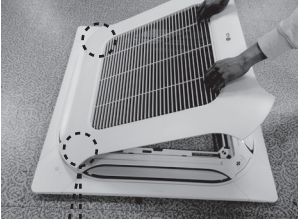

Separate the link from the front grill

- 2 Remove the Corner covers of the panel.

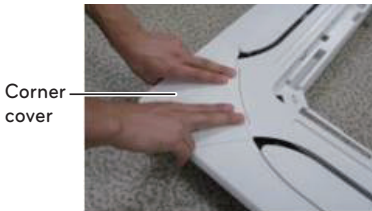

- 3 Fit the panel on the unit by inserting hooks as shown in picture.

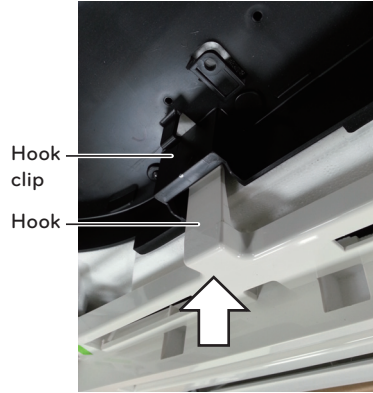

- 4 Insert two screws on diagonal corners of panel. Do not tighten the bolts completely. (The fixing screws are included in the indoor unit box.)
Check the alignment of panel with the ceiling. Height can be adjusted using hanging bolts as shown in picture. Insert the other two screws and tighten all screws completely.



5 Fit the corner covers.

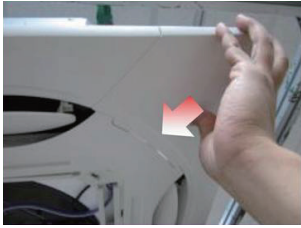

6 Open two screws of control panel cover.

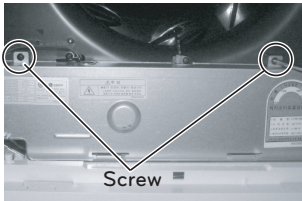

7 Connect one display connector and two vane control connectors of front panel to indoor unit PCB.

The position marking on PCB is as:
 Display connector : CN_DISPLAY
 Vane control connector: CN_VANE 1,2

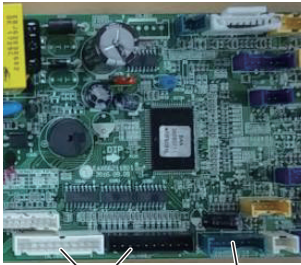

CN_VANE 1,2 CN_DISPLAY

8 Close the cover for control box.

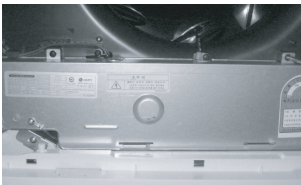

9 Install the air inlet grille and Filter on the panel.

- After inserting the edge of the grill into the panel body, close the door lock and press on the left, right, and center sections.

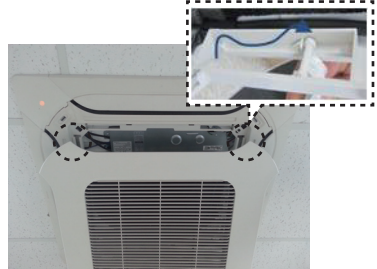

Installing the grill link on the panel body

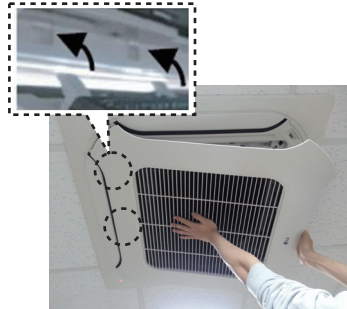

Inserting the edge into the panel body



Closing the door lock



Check the left, right and central sections

! CAUTION

Install certainly the decorative panel.
Cool air leakage causes sweating.
☞ Water drops fall.

Good example

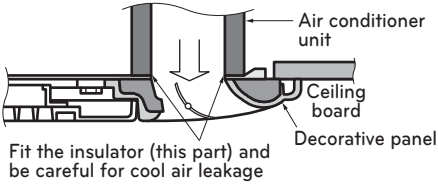

Bad example

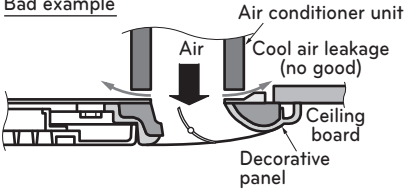

PRECAUTIONS IN TEST RUN

- The initial power supply must provide at least 90 % of the rated voltage.
Otherwise, the air conditioner should not be operated.

! CAUTION

- For test run, carry out the cooling operation firstly even during heating season. If heating operation is carried out firstly, it leads to the trouble of compressor. Then attention must be paid.
- Carry out the test run more than 5 minutes without fail.
(Test run will be cancelled 18 minutes later automatically)

- To cancel the test run, press any button.

CHECK THE FOLLOWING ITEMS WHEN INSTALLATION IS COMPLETED

- After completing work, be sure to measure and record trial run properties, and store measured data, etc.
- Measuring items are room temperature, outside temperature, suction temperature, blow out temperature, wind velocity, wind volume, voltage, current, presence of abnormal vibration and noise, operating pressure, piping temperature, compressive pressure.
- As to the structure and appearance, check following items.
 - * Is the circulation of air adequate?
 - * Is the draining smooth?
 - * Is the heat insulation complete (refrigerant and drain piping)?
 - * Is there any leakage of refrigerant?
 - * Is the remote controller switch operated?
 - * Is there any faulty wiring?
 - * Are there any terminal screws loosened?

- M4.....118 N-cm{12 kgf-cm}
- M5.....196 N-cm{20 kgf-cm}
- M6.....245 N-cm{25 kgf-cm}
- M8.....588 N-cm{60 kgf-cm}

Connection of power supply

- Connect the power supply cord to the independent power supply.
Circuit breaker is required.
- Operate the unit for 15 minutes or more.

Evaluation of the performance

- Measure the temperature of the intake and discharge air.
- Ensure the difference between the intake temperature and the discharge one is more than 8 °C (Cooling) or reversely (Heating).

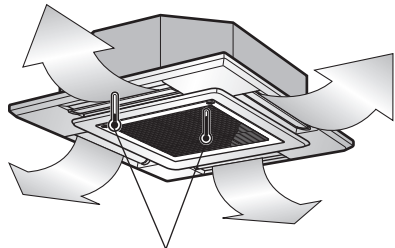

Thermometer

Test operation

During the TEST OPERATION, the unit operates in cooling mode at high speed fan, regardless of room temperature and resets in 18 minutes. During test operation, if remote controller signal is received, the unit operates as remote controller sets. If you want to use this operation, **Press and hold the ON/OFF button for 3~5 seconds**, then the buzzer sound 1 'beep'. If you want to stop the operation, re-press the button.

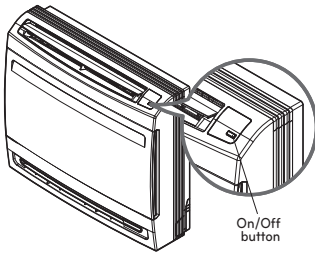

Self-Diagnosis Function

This unit has an inbuilt error diagnosis capability. Error is displayed by 'RED' Operation Lamp. Please contact your serviceman/dealer in such a situation

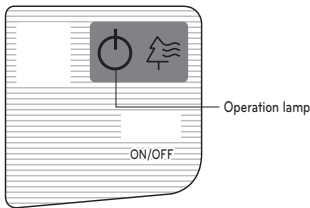
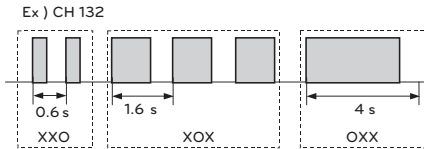

Evaluation of the performance

Operate the unit for 10~15 minutes, then check the system refrigerant charge:

- 1 Measure the pressure of the gas side service valve.
- 2 Measure the air temperature from inlet and outlet of air conditioner.
- 3 Ensure the difference between the inlet and outlet temperature is more than 8 °C.
- 4 For reference; the gas side pressure at optimum condition is shown on table (cooling)

The air conditioner is now ready to use.

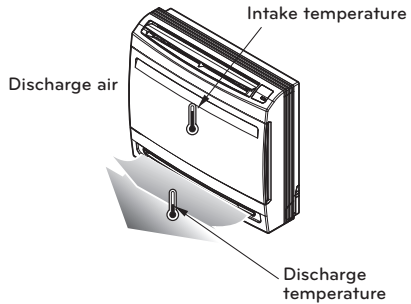

Refrigerant	Outside ambient TEMP.	The pressure of the gas side
R-410A	35 °C (95 °F)	8.5~9.5 kg/cm ² G (120~135 P.S.I.G.)

NOTE

If the actual pressure is higher than shown, the system is most likely over-charged, and charge should be removed. If the actual pressure are lower than shown, the system is most likely undercharged, and charge should be added.

INSTALLATION INSTRUCTIONS

Installer Setting - How to enter installer setting mode

! CAUTION

Installer setting mode is to set the detail function of the remote controller.

If the installer setting mode is not set correctly, it can cause problems to the product, user injury or property damage. This must be set by an certificated installer, and any installation or change that is carried out by a non-certificated person should be responsible for the results.

In this case, free service cannot be provided.

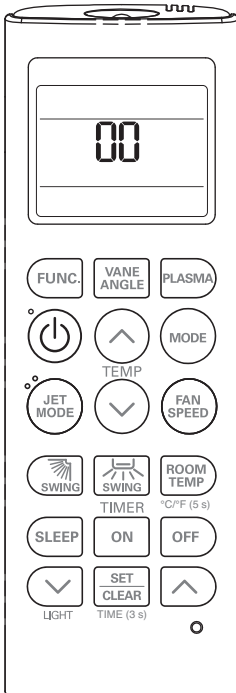

- 1 With the JET MODE button pressed, press the RESET button.
- 2 By using the TEMPERATURE SETTING button, set function code and setting value. (Please refer the Installer Setting Code Table.)
- 3 Press the ON/OFF button toward the indoor unit 1 time.
- 4 Reset the remote controller to use the general operation mode.

Refer to the Installer Setting Code Table on the next page.

Installer Setting - Installer Setting Code Table

Installer Setting Code Table

No.	Function	Function code	Setting value	Remote controller LCD
0	Mode override	0	0 : Set to master	00
			1 : Set to slave	01
1	Ceiling height Selection	1	1 : Standard	11
			2 : Low	12
			3 : High	13
			4 : Super high	14
2	Group control	2	0 : Set to master	20
			1 : Set to slave	21
			2 : Check master/slave	22
	Auxiliary heater	2	3 : Set to auxiliary heater	23
			4 : Cancel auxiliary heater	24
5 : Check auxiliary heater Installation			25	

Mode Override

This Function is only for Non-Auto Changeover H/P model.

Ceiling Height Selection

Indoor unit connected to wired remote controller operate as wired remote controller setting.

Group Control (optional)

This function is only for group control. Please don't set this function in case of non-group control.

After setting group control of the product, turn off the power then turn it back on after 1 minute.

Auxiliary heater

This function is only applied to models with Auxiliary Heater function being activated.

Installer Setting - Setting Address of Central Control

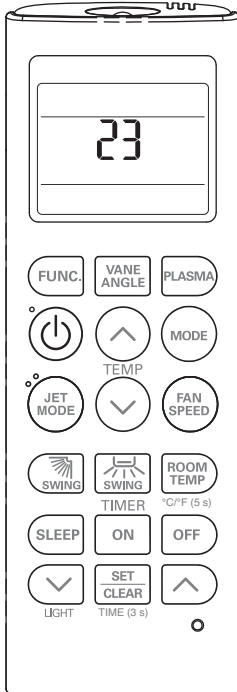

- 1 With the MODE button pressed, press the RESET button.
- 2 By using the temperature setting button, set the indoor unit address.
 - Setting range : 00 ~ FF
- 3 After setting the address, press the ON/OFF button toward the indoor unit 1 time.
- 4 The indoor unit will display the set address to complete the address setting.
 - The address display time and method can differ by the indoor unit type.
- 5 Reset the remote controller to use the general operation mode.

Installer Setting - Checking Address of Central Control

- 1 With the FUNC. button pressed, press the RESET button.
- 2 Press the ON/OFF button toward the indoor unit 1 time, and the indoor unit will display the set address in the display window.
 - The address display time and method can differ by the indoor unit type.
- 3 Reset the remote controller to use the general operation mode.

Installer Setting - Static Pressure Step Setting

This function is applied to only duct type. Setting this in other cases will cause malfunction.

This function is only available on some products.

This is the function that static pressure of the product is divided in 11 steps for setting.

Ceiling Concealed Duct – Low static

Table 1

Chassis	Capacity (kBtu/h)	Grade	Step	CMM	Static Pressure [mmAq(Pa)]					
					0(0)	1(10)	2(20)	3(29)	4(39)	5(49)
					Setting Value					
					32:01	32:02	32:03	32:04	32:05	32:06
L5	9	Standard Compact	LOW	8	76	87	96	106	116	116
			MID	9.5	87	96	106	114	120	120
			HIGH	11.5	101	109	118	125	130	130
L5	12	Standard Compact	LOW	8	76	87	96	106	116	116
			MID	9.5	87	96	106	114	120	120
			HIGH	11.5	101	109	118	125	130	130
L6	18	Standard Compact	LOW	10	82	87	90	96	106	116
			MID	12.5	92	98	105	109	119	128
			HIGH	15	100	106	112	122	129	137
L3	24	Standard Compact	LOW	12	89	95	102	106	120	130
			MID	16	102	108	115	125	131	139
			HIGH	20	125	131	136	141	142	147
L5	12	High	LOW	8	76	87	96	106	116	116
			MID	9.5	87	96	106	114	120	120
			HIGH	11.5	101	109	118	125	130	130
L3	18	High	LOW	10	80	90	95	100	110	120
			MID	14	97	103	109	117	126	134
			HIGH	18	115	122	127	133	138	142

NOTE

1. The above table shows the correlation between the air rates and E.S.P.
2. Be sure to set the value referring table 1. Unexpected set value will cause mal-function.
3. Table 1 is based at 230 V. According to the fluctuation of voltage, air flow rate varies.

Ceiling Concealed Duct – Mid static

Table 2

Chassis	Capacity (kBtu/h)	Grade	Step	CMM	Static Pressure [mmAq(Pa)]										
					2(20)	2.5(25)	3(29)	4(39)	6(59)	8(78)	10(98)	12(118)	13(127)	14(137)	15(147)
					Setting Value										
					32:01	32:02	32:03	32:04	32:05	32:06	32:07	32:08	32:09	32:10	32:11
M1	18	Standard Compact	LOW	13	73	74	77	88	93	103	111	117	120	125	128
			MID	14.5	76	77	86	91	97	107	114	121	125	128	131
			HIGH	16.5	86	87	90	94	103	110	118	125	128	131	134
M1	24	Standard Compact	LOW	14.5	76	77	86	89	97	106	114	121	124	127	130
			MID	16.5	86	87	90	94	103	111	118	125	128	131	134
			HIGH	18	90	92	95	99	108	115	122	129	132	135	138
M1	12	High	LOW	9	64	67	70	72	81	94	103	110	113	117	121
			MID	12	68	72	74	76	86	100	108	115	118	121	125
			HIGH	16	81	86	89	93	98	110	118	124	127	131	135
M1	18	High	LOW	14	76	77	86	89	97	107	114	121	124	127	130
			MID	16	86	87	90	94	103	111	118	125	128	131	134
			HIGH	17.5	90	92	95	99	108	115	122	129	132	135	138

Chassis	Capacity (kBtu/h)	Grade	Step	CMM	Static Pressure [mmAq(Pa)]										
					2.5(25)	4(39)	5(49)	6(59)	7(69)	8(78)	9(88)	10(98)	11(108)	13(127)	15(147)
					Setting Value										
					32:01	32:02	32:03	32:04	32:05	32:06	32:07	32:08	32:09	32:10	32:11
M1	30	Standard Compact	LOW	18	96	102	107	110	114	118	122	125	127	130	132
			MID	20	102	110	114	118	121	125	127	130	133	134	136
			HIGH	22	110	117	121	124	127	130	133	136	137	138	140
M2	24	High	LOW	21	84	88	89	90	95	96	100	105	110	112	113
			MID	24	88	92	94	95	100	101	108	113	118	118	118
			HIGH	28	92	96	99	101	105	108	115	118	124	124	124
M2	30	High	LOW	21	84	88	89	90	95	96	100	105	110	112	113
			MID	24	88	92	94	95	100	101	108	113	118	118	118
			HIGH	28	92	96	99	101	105	108	115	118	124	124	124

Chassis	Capacity (kBtu/h)	Grade	Step	CMM	Static Pressure [mmAq(Pa)]											
					4(39)	5(49)	6(59)	7(69)	8(78)	9(88)	10(98)	11(108)	12(118)	13(127)	15(147)	
					Setting Value											
					32:01	32:02	32:03	32:04	32:05	32:06	32:07	32:08	32:09	32:10	32:11	
M2	36	Standard Compact	LOW	24	88	91	95	100	101	108	113	115	118	118	118	
			MID	28	93	97	101	105	108	115	118	120	124	124	124	
			HIGH	32	101	105	109	112	115	119	123	126	128	128	128	
M3	48	Standard Compact	LOW	28	74	76	79	82	89	92	94	96	99	102	107	
			MID	34	78	82	84	89	94	96	98	101	104	106	112	
			HIGH	40	83	89	92	94	98	100	102	105	108	110	116	
M3	48	High	LOW	28	74	76	79	82	89	92	94	96	99	102	107	
			MID	34	78	82	84	89	94	96	98	101	104	106	112	
			HIGH	40	83	89	92	94	98	100	102	105	108	110	116	
M3	36	High	LOW	28	74	76	79	82	89	92	94	96	99	102	107	
			MID	34	78	82	84	89	94	96	98	101	104	106	112	
			HIGH	40	83	89	92	94	98	100	102	105	108	110	116	
M3	42	High	LOW	28	74	76	79	82	89	92	94	96	99	102	107	
			MID	34	78	82	84	89	94	96	98	101	104	106	112	
			HIGH	40	83	89	92	94	98	100	102	105	108	110	116	
M3	60	Standard Compact	LOW	40	82	89	92	94	98	100	102	105	108	110	113	
			MID	45	90	92	96	98	102	104	106	109	112	114	117	
			HIGH	50	94	97	100	104	107	109	112	115	117	119	121	

Chassis	Capacity (kBtu/h)	Grade	Step	CMM	Static Pressure [mmAq(Pa)]										
					5(49)	6(59)	7(69)	8(78)	9(88)	10(98)	11(108)	12(118)	13(127)	14(137)	15(147)
					Setting Value										
					32:01	32:02	32:03	32:04	32:05	32:06	32:07	32:08	32:09	32:10	32:11
M2	42	Standard Compact	LOW	28	100	103	106	110	114	118	121	125	128	133	136
			MID	33	108	111	114	118	122	125	128	131	134	138	140
			HIGH	38	117	120	124	127	130	133	135	138	140	144	147

NOTE

1. Be sure to set the value referring table 2. Unexpected set value will cause mal-function.
2. Table 2 is based at 230 V. According to the fluctuation of voltage, air flow rate varies.
3. Factory Set(External Static Pressure) each Model

Capacity (kBtu/h)	Factory set (E.S.P.) mmAq(Pa)
18	6(59)
24	
30	
36	
42	
48	
60	

* If it is zero static pressure, please set value below Maximum value.

Chassis	Maximum value
M1	115
M2	120
M3	98

Installer Setting - Auto ESP

This function automatically sets the rotation speed of the fans corresponding to each step of rated airflow for easy installation.

Please refer to the manual for separately sold remote control for detailed setup.

NOTE

If this function is incorrectly set especially, in case of mismatching the voltage, the air conditioner may malfunction.
This function must be set by the installation specialist that holds an installation license.
(please check the product type)

NOTE

- If the heat exchanger is not dry, please set the device to operate in air circulation mode for 15 minutes.
- The air filter must be properly attached to the suction side of the product.
- Adjust the dampers so that each air inlet and outlet exhaust the required air.
- Please do not use the set auto air flow function when using various booster fans (outdoor air treatment device or ERV through ducts).
- Please reinitiate the set auto air flow function if the duct shape has changed since its initial installation.
- When setting the voltage manually, the set air flow will differ from the actual air flow if the set voltage is different from the actual voltage.
- When setting voltage manually, measure the actual voltage and select the set voltage on the remote control.
- Failure to follow the above method may cause the actual air flow to differ from the rated air flow.

DIP SWITCH SETTING



	Function	Description	Setting Off	Setting On	Default
SW3	Group Control	Selection of Master or Slave	Master	Slave	Off
SW4	Dry Contact Mode	Selection of Dry Contact Mode	Wired/Wireless remote controller Selection of Manual or Auto operation Mode	Auto	Off
SW5	Installation	Fan continuous operation	Continuous operation Removal	Working	Off



Manufacturer :
LG Electronics Inc.
84, Wanam-ro, Seongsan-gu, Changwon-si, Gyeongsangnam-do, KOREA

UK Importer : LG Electronics U.K. Ltd
Velocity 2, Brooklands Drive, Weybridge, KT13 0SL

Eco design requirement

- The information for Eco design is available on the following free access website.
<https://www.lg.com/global/support/cedoc/cedoc>