



ENGLISH

ESPAÑOL

PORTUGUÊS

OWNER'S MANUAL

AIR CONDITIONER

Please read this manual carefully before operating your set and retain it for future reference.

CEILING CASSETTE - 1WAY



MFL67655306
Rev.03_031721

www.lg.com

Copyright © 2015 - 2021 LG Electronics Inc. All Rights Reserved.

TABLE OF CONTENTS

3 SAFETY INSTRUCTIONS

6 PRIOR TO OPERATION

- 6 Preparing for Operation
- 6 Usage
- 6 Cleaning and Maintenance
- 6 Service
- 6 Current

7 PART DESCRIPTION

8 OPERATING INSTRUCTIONS

- 8 How to insert the Batteries
- 8 Wireless Remote Controller Maintenance
- 8 Operating Method
- 9 Using Wireless Remote Control
- 10 Using the Mode Function
- 12 Using the Auto Operation Function
- 13 Using the Temperature Setting Function
- 14 Using the Fan Speed Function
- 14 Using the Air Flow Direction Function
- 16 Using the Optional Function
- 17 Using Special Functions
- 19 Timer Functions
- 21 How to set Air quality level color
- 21 Forced Operation
- 21 Auto Restart Function

22 MAINTENANCE AND SERVICE (WITH AIR PURIFIER)

- 26 When the air conditioner is not going to be used for a long time.
- 26 Operation Tips
- 27 Before you call for service...

Safety instructions

The following safety guidelines are intended to prevent unforeseen risks or damage from unsafe or incorrect operation of the appliance.

The guidelines are separated into 'WARNING' and 'CAUTION' as described below.

-  This symbol is displayed to indicate matters and operations that can cause risk.
Read the part with this symbol carefully and follow the instructions in order to avoid risk.

WARNING

This indicates that the failure to follow the instructions can cause serious injury or death.

CAUTION

This indicates that the failure to follow the instructions can cause the minor injury or damage to the product.

WARNING

Installation

- Do not use a defective or underrated circuit breaker. Use this appliance on a dedicated circuit.
 - There is risk of fire or electric shock.
- For electrical work, contact the dealer, seller, a qualified electrician, or an Authorized Service Center.
 - Do not disassemble or repair the product. There is risk of fire or electric shock.
- Always ground the product.
 - There is risk of fire or electric shock.
- Install the panel and the cover of control box securely.
 - There is risk of fire or electric shock.
- Always install a dedicated circuit and breaker.
 - Improper wiring or installation may cause fire or electric shock.
- Use the correctly rated breaker or fuse.
 - There is risk of fire or electric shock.
- Do not modify or extend the power cable.
 - There is risk of fire or electric shock.
- Do not install, remove, or re-install the unit by yourself (customer).
 - There is risk of fire, electric shock, explosion, or injury.
- Be cautious when unpacking and installing the product.
 - Sharp edges could cause injury. Be especially careful of the case edges and the fins on the condenser and evaporator.
- For installation, always contact the dealer or an Authorized Service Center.
 - There is risk of fire, electric shock, explosion, or injury.
- Do not install the product on a defective installation stand.
 - It may cause injury, accident, or damage to the product.
- Be sure the installation area does not deteriorate with age.
 - If the base collapses, the air conditioner could fall with it, causing property damage, product failure, and personal injury.
- Do not turn on the breaker or power under condition that front panel, cabinet, top cover, control box cover are removed or opened.
 - Otherwise, it may cause fire, electric shock, explosion or death.
- Use a vacuum pump or Inert (nitrogen) gas when doing leakage test or air purge. Do not compress air or Oxygen and Do not use Flammable gases. Otherwise, it may cause fire or explosion.
 - There is the risk of death, injury, fire or explosion.

Operation

- Do not let the air conditioner run for a long time when the humidity is very high and a door or a window is left open.
 - Moisture may condense and wet or damage furniture.
- Take care to ensure that power cable could not be pulled out or damaged during operation.
 - There is risk of fire or electric shock.
- Do not place anything on the power cable.
 - There is risk of fire or electric shock.
- Do not plug or unplug the power supply plug during operation.
 - There is risk of fire or electric shock.
- Do not touch(operate) the product with wet hands.
 - There is risk of fire or electrical shock.
- Do not place a heater or other appliances near the power cable.
 - There is risk of fire and electric shock.
- Do not allow water to run into electric parts.
 - It may cause There is risk of fire, failure of the product, or electric shock.
- Do not store or use flammable gas or combustibles near the product.
 - There is risk of fire or failure of product.
- Do not use the product in a tightly closed space for a long time.
 - Oxygen deficiency could occur.
- When flammable gas leaks, turn off the gas and open a window for ventilation before turn the product on.
 - Do not use the telephone or turn switches on or off. There is risk of explosion or fire.
- If strange sounds, or smell or smoke comes from product. Turn the breaker off or disconnect the power supply cable.
 - There is risk of electric shock or fire.
- Stop operation and close the window in storm or hurricane. If possible, remove the product from the window before the hurricane arrives.
 - There is risk of property damage, failure of product, or electric shock.
- Do not open the inlet grill of the product during operation. (Do not touch the electrostatic filter, if the unit is so equipped.)
 - There is risk of physical injury, electric shock, or product failure.
- When the product is soaked (flooded or submerged), contact an Authorized Service Center.
 - There is risk of fire or electric shock.
- Be cautious that water could not enter the product.
 - There is risk of fire, electric shock, or product damage.
- Ventilate the product from time to time when operating it together with a stove, etc.
 - There is risk of fire or electric shock.
- Turn the main power off when cleaning or maintaining the product.
 - There is risk of electric shock.
- When the product is not be used for a long time, disconnect the power supply plug or turn off the breaker.
 - There is risk of product damage or failure, or unintended operation.
- Take care to ensure that nobody could step on or fall onto the outdoor unit.
 - This could result in personal injury and product damage.



CAUTION

Installation

- Always check for gas (refrigerant) leakage after installation or repair of product.
 - Low refrigerant levels may cause failure of product.
- Install the drain hose to ensure that water is drained away properly.
 - A bad connection may cause water leakage.
- Keep level even when installing the product.
 - To avoid vibration or water leakage.
- Do not install the product where the noise or hot air from the outdoor unit could damage the neighborhoods.
 - It may cause a problem for your neighbors.

- Use two or more people to lift and transport the product.
 - Avoid personal injury.
- Do not install the product where it will be exposed to sea wind (salt spray) directly.
 - It may cause corrosion on the product. Corrosion, particularly on the condenser and evaporator fins, could cause product malfunction or inefficient operation.
- Contact the authorized service technician for repair or maintenance of this unit.
- Contact the installer for installation of this unit.
- When the power cord is to be replaced, replacement work shall be performed by authorized personnel only using only genuine replacement parts.
- Installation work must be performed in accordance with the National Electric Code by qualified and authorized personnel only.
- If anyone other than a licensed professional installs, repairs, or alters LG Electronics air conditioning products, the warranty is voided.
 - All costs associated with repair are then the full responsibility of the owner.
- Do not install the unit in potentially explosive atmospheres.

Operation

- Do not expose the skin directly to cool air for long periods of time. (Don't sit in the draft.)
 - This could harm to your health.
- Do not use the product for special purposes, such as preserving foods, works of art, etc. It is a consumer air conditioner, not a precision refrigeration system.
 - There is risk of damage or loss of property.
- Do not block the inlet or outlet of air flow.
 - It may cause product failure.
- Use a soft cloth to clean. Do not use harsh detergents, solvents, etc.
 - There is risk of fire, electric shock, or damage to the plastic parts of the product.
- Do not touch the metal parts of the product when removing the air filter. They are very sharp!
 - There is risk of personal injury.
- Do not step on or put anything on the product. (outdoor units)
 - There is risk of personal injury and failure of product.
- Always insert the filter securely. Clean the filter every two weeks or more often if necessary.
 - A dirty filter reduces the efficiency of the air conditioner and could cause product malfunction or damage.
- Do not insert hands or other objects through the air inlet or outlet while the product is operated.
 - There are sharp and moving parts that could cause personal injury.
- Do not drink the water drained from the product.
 - It is not sanitary and could cause serious health issues.
- Use a firm stool or ladder when cleaning or maintaining the product.
 - Be careful and avoid personal injury.
- Replace the all batteries in the remote control with new ones of the same type. Do not mix old and new batteries or different types of batteries.
 - There is risk of fire or explosion.
- Do not recharge or disassemble the batteries. Do not dispose of batteries in a fire.
 - They may burn or explode.
- If the liquid from the batteries gets onto your skin or clothes, wash it well with clean water. Do not use the remote if the batteries have leaked.
 - The chemicals in batteries could cause burns or other health hazards.
- If you eat the liquid from the batteries, brush your teeth and see doctor. Do not use the remote if the batteries have leaked.
 - The chemicals in batteries could cause burns or other health hazards.
- This appliance is not intended for use by persons (including children) with reduced physical, sensory or mental capabilities, or lack of experience and knowledge unless they have been given supervision or instruction concerning use of the appliance by a person responsible for their safety.
 - Children should be supervised to ensure that they do not play with the appliance.
- The user must carry out checks and cleaning of routine to avoid defective performance.
 - In a special situation, only service personnel can carry out repair work.

Prior to Operation

Preparing for Operation

1. Contact an installation specialist for installation.
2. Use a dedicated circuit.

Usage

1. Being exposed to direct airflow for an extended period of time could be hazardous to your health. Do not expose occupants, pets, or plants to direct airflow for extended periods of time.
2. Due to the possibility of oxygen deficiency, ventilate the room when used together with stoves or other heating devices.
3. Do not use this air conditioner for non-specified special purposes (e.g. preserving precision devices, food, pets, plants, and art objects). Such usage could damage the items.

Cleaning and Maintenance

1. Do not touch the metal parts of the unit when removing the filter. Injuries can occur when handling sharp metal edges.
2. Do not use water to clean inside the air conditioner. Exposure to water can destroy the insulation, leading to possible electric shock.
3. When cleaning the unit, first make sure that the power and breaker are turned off. The fan rotates at a very high speed during operation. There is a possibility of injury if the unit's power is accidentally triggered on while cleaning inner parts of the unit.

Service

For repair and maintenance, contact your authorized service dealer.

Current

Model	Voltage, Hz	Current(A)
AMNW09GTUC0	220 V~ 60 Hz	0.2
AMNW12GTUC0		

Part Description

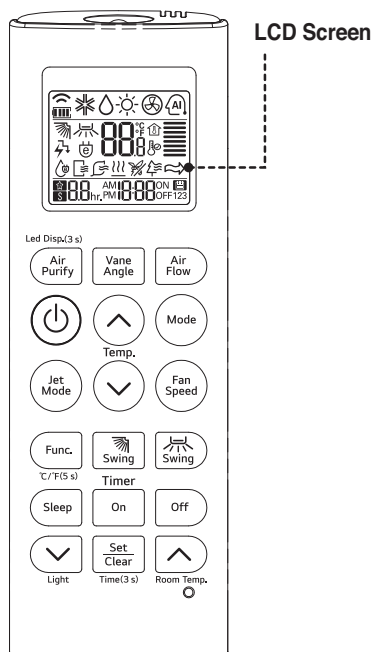

Wireless Remote Controller

Accessory



Holder(1 EA)



Fixing Screw (2 EA)

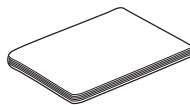

Owner's / Installation
Manual

Operating Instructions

How to insert the Batteries

1. Remove the battery cover by pulling it according to the arrow direction.
2. Insert new batteries making sure that the (+) and (-) of battery are installed correctly.
3. Reattach the cover by sliding it back into position.

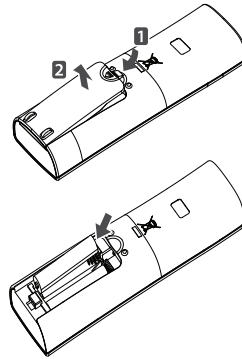

NOTE

1. Always use/replace both batteries of same type.
2. If the system is not to be used for a long time, remove the batteries to save their working life.
3. If the display screen of remote controller starts, fading replace both of the batteries.
4. Batteries from regionally certified organizations must be used.

Wireless Remote Controller Maintenance

1. Choose a suitable place where its safe & easy to reach.
2. Fix the holder to wall etc with the supplied screws firmly.
3. Slide the remote controller inside the holder.

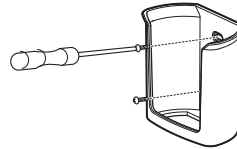

NOTE

1. Remote controller should never be exposed to direct sunlight.
2. Signal transmitter & receiver should always be clean for proper communication. Use a soft cloth to clean them.
3. In case some other appliances also get operated with remote control, change their position or consult your serviceman.

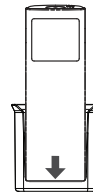

Operating Method

1. The signal receiver is inside the unit.
2. Aim the remote controller towards the unit to operate it.
There should not be any blockage in between.

Using Wireless Remote Control

You can operate the air conditioner more conveniently with the remote control.

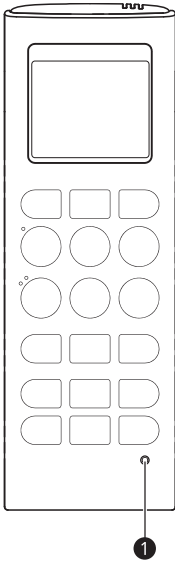

Button	Display Screen	Description
	-	Used to turn on/off the unit.
AIR PURIFY		Used to start or stop the air purification function.
PLASMA		Used to start or stop the plasma-purification function.
VANE ANGLE		Used to set each vane angle.
AIR FLOW		Used to set airflow.
		Used to select the room temperature.
MODE	-	Used to select the operation mode.
JET MODE		To change room temperature quickly.
JET COOL		
FAN SPEED	-	To adjust the fan speed.
FUNC.	-	Used to set or clear additional function.
		To adjust the air flow direction vertically or horizontally.
ROOM TEMP		Used to check the room temperature.
SLEEP		Used to set the time for the sleep function.
ON	-	Used to set the start time.
OFF	-	Used to set the stop time.
	-	Used to set the timer. Used to adjust the brightness. Used to check the room temperature. (If it is not time adjust mode)
SET/CLEAR	-	Used to set/clear the timer. Used to set the current time. (hold button for 3 seconds)
RESET	-	To initialize the remote control settings.



NOTE

- Depending on the product type, some functions may not be available and displayed.
- Some products don't receive the wired signals.
- When using the simultaneous operation system, the system will operate approximately 1 - 2 minutes after pressing the remote controller button.
- The displayed temperature can be different from the actual room temperature if the remote controller is installed somewhere exposed to direct sunlight or is nearby a heat source.
- Depending on the product, wireless and wired remote control are optional or basic.
- Heating Mode is not available for Cooling only Models.
- Buttons may be changed according to the type of model.

Using the Mode Function

Cooling Mode

This cools the room with a comfortable and clean wind.

- 1 Turn the appliance on.
- 2 Press **MODE** button repeatedly to select the Cooling Mode.
 -  is displayed on the display screen.
- 3 Press  or  button to set the desired temperature.
- 4 Press **FAN SPEED** button repeatedly to adjust the fan speed.

NOTE

- Press the **ROOM TEMP** button to check the Room temperature.
- When setting the desired temperature higher than the current room temperature, the unit will produce only ventilation wind.

Power Cooling Mode

This cools the room with a comfortable and clean wind.

- 1 Turn the appliance on.
- 2 Press **MODE** button repeatedly to select the Cooling Mode.
- 3 Press **JET MODE** or **JET COOL** button.
 -  is displayed on the display screen.

NOTE

- To cancel the Power Cooling Mode, Press the **JET MODE** or **JET COOL** button, the **FAN SPEED** button or the **ROOM TEMP** button.
- This rapidly lowers the room temperature.
- Partial appliance has no Power Cooling function.
- The unit will operate at a high fan speed in cooling mode.
- The feature may be changed according to the type of model.

Dehumidification Mode

It removes humidity while slightly cooling the air.



- 1 Turn the appliance on.
- 2 Press **MODE** button repeatedly to select the Dehumidification Mode.
 -  is displayed on the display screen.
- 3 Press **FAN SPEED** button repeatedly to adjust the fan speed.

NOTE

- The temperature setting can not be adjusted when this mode is operating.
- During rainy seasons or in high-humidity climates, it is possible to simultaneously operate the dehumidifier and cooling mode to remove humidity effectively.
- The menu item of wind powerfulness might not be partially selected according to the product.

Heating Mode

This supplies warm wind to the inside of the building.

- 1 Turn the appliance on.
- 2 Press **MODE** button repeatedly to select the Heating Mode.
 -  is displayed on the display screen.
- 3 Press  or  button to set the desired temperature.
- 4 Press **FAN SPEED** button repeatedly to adjust the fan speed.

NOTE

- Press the **ROOM TEMP** button to check the Room temperature.
- When setting the desired temperature lower than the room temperature, the unit will produce only ventilation wind.
- Heating Mode is not available for Cooling only models.
- To check the indoor temperature, press the room temperature button.

Power Heating Mode

- 1 Turn the appliance on.
- 2 Press **MODE** button repeatedly to select the Heating Mode.
- 3 Press **JET MODE** button.
 -  is displayed on the display screen.

NOTE

- Heating Mode is not available for Cooling only models.
- Some functions may not be supported, depending on the model.

Fan Mode

- 1 Turn the appliance on.
- 2 Press **MODE** button repeatedly to select the Fan Mode.
 -  is displayed on the display screen.
- 3 Press **FAN SPEED** button repeatedly to adjust the fan speed.

NOTE

- Natural wind based on chaos logic
 - For a fresher feeling than other fan speeds, press the Indoor Fan Speed Selector and set to chaos mode. In this mode, the wind blows like a natural breeze by automatically changing fan speed based on the chaos logic.
- During Fan Mode
 - The outdoor compressor doesn't work. Have a function to circulate the indoor as it sends out the air that doesn't have much temperature difference with indoor.

Using the Auto Operation Function

Auto Operation Mode

This mode automatically sets the fan speed and temperature depending on the room temperature.

Cooling Only Model

In this mode, you cannot adjust the fan speed, but you can set the air deflector to rotate automatically.

1 Turn the appliance on.

2 Press **MODE** button repeatedly to select the Auto Operation Mode.

-  is displayed on the display screen.



3 Press  or  button to set the desired temperature.

- Please select the code depend on your feeling.



Code	Description
2	Cold
1	Slightly cool
0	Neutral
-1	Slightly warm
-2	Warm

Cooling & Heating Model

This mode changes the mode automatically to maintain the set temperature at ± 2 °C.

1 Turn the appliance on.

2 Press **MODE** button repeatedly to select the Auto Operation Mode.

-  is displayed on the display screen.

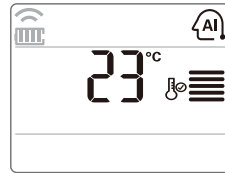

3 Press  or  button to set the desired temperature.



- Setting temp range: 18 °C ~ 30 °C

4 Press **FAN SPEED** button repeatedly to adjust the fan speed.

Auto Changeover Mode - Setting the Mode Change Temperature

Cooling & Heating Model

The Mode Change Temperature is the difference of temperature when from cooling mode to heating mode or from heating mode to cooling mode.

- 1 In Auto Operation Mode, Press the **FUNC.** button to select Setting the Mode Change Temperature.
- 2 Press  or  button to set desired Mode Change Temperature.
 - Default value is 2 °C
 - Setting temp range: 1 °C ~ 7 °C





NOTE

When setting temperature is 25 °C and room temperature is 20 °C, then operating mode is heating. If you set the mode change temperature to 2 °C, when the room temperature up to 27 °C(25 °C + 2 °C), the unit start cooling operation.

Using the Temperature Setting Function

Temperature setting

Use this function to adjust the desired temperature.

-  : Increase 1 °C or 1 °F each time pressed.
-  : Decrease 1 °C or 1 °F each time pressed.

NOTE

- 5 °C is proper for the difference between room and outside temperature.
- Cooling operation
 - The cooling mode doesn't work if the desired temperature is higher than room temperature. Please lower the desired temperature.
 - Setting temp range: 18 °C ~ 30 °C
- Heating operation
 - The heating mode doesn't work if the desired temperature is lower than room temperature.
 - Please increase the desired temperature.
 - Setting temp range: 16 °C ~ 30 °C

- When pressing the **FAN SPEED** button of the remote controller for approx. 3 seconds, the room temperature will be displayed for about 5 seconds before returning to the previous display panel.

- Some functions may not be supported, depending on the model.

Switching Between Celsius/Fahrenheit

Press and hold the **ROOM TEMP** or **FUNC.** button long for 5 seconds to change from Celsius to Fahrenheit or from Fahrenheit to Celsius.

NOTE

- Some functions may not be supported, depending on the model.

Using the Fan Speed Function

Adjusting the Fan Speed

- 1 Turn the appliance on.
- 2 Press **FAN SPEED** button repeatedly to adjust the fan speed.



NOTE

- The menu item might not be partially selected according to product function.
- The feature may be changed according to the type of model.

Using the Air Flow Direction Function

Up/Down Airflow Direction Control (Optional)

The up/down airflow (Vertical Airflow) can be adjusted by using the remote controller.



- 1 Turn the appliance on.
- 2 Press  button.
 - The louvers will swing up and down.
- 3 Press  button again to set the vertical louver at the desired airflow direction.

NOTE

- If you press  button, the horizontal airflow direction is changed automatically based on the Auto Swing algorithm to distribute the air in the room evenly and at the same time to make the human body feel more comfortable, as if enjoying a natural breeze.
- Always use the remote controller to adjust the up/down airflow direction. Manually moving the vertical airflow direction louver by hand, could damage the air conditioner.
- When the unit is shut off, the up/down airflow direction louver will close the air outlet vent of the system.
- Some functions may not be supported, depending on the model.

Left/Right Airflow Direction Control (Optional)

The left/right (horizontal) airflow can be adjusted by using the remote control.

- 1 Turn the appliance on.
- 2 Press  button.
 - The louvers will swing left and right.
- 3 Press  button again to set the horizontal louver at the desired airflow direction.

NOTE

- Some functions may not be supported, depending on the model.

Indirect Wind (Optional)

It adjusts the wind direction to indirect wind.

- 1 Turn the appliance on.
- 2 Press **AIR FLOW** button repeatedly until  icon displayed.
- 3 Press **SET/CLEAR** button to set or cancel this function.

NOTE

Some functions may not be supported, depending on the model.

Direct Wind (Optional)

It adjusts the wind direction to direct wind.

- 1 Turn the appliance on.
- 2 Press **AIR FLOW** button repeatedly until  icon displayed.
- 3 Press **SET/CLEAR** button to set or cancel this function.

NOTE

Some functions may not be supported, depending on the model.

Smart Mode (Optional)

It is the function to set the Smart Mode operation of the product.





- 1 Turn the appliance on.
- 2 Press **AIR FLOW** button repeatedly until  icon displayed.
- 3 Press **SET/CLEAR** button to set or cancel this function.

NOTE

- Smart Mode function can only be selected in the cooling and heating modes.
- Smart Mode / Energy Saving Cooling / Refresh Mode functions cannot be set at the same time.
- Some functions may not be supported, depending on the model.

Refresh Mode (Optional)

It is the function to set the Refresh Mode operation of the product.

- 1 Turn the appliance on.
- 2 Press **AIR FLOW** button repeatedly until  icon displayed.
- 3 Press **SET/CLEAR** button to set or cancel this function.
- 4 When set, it is displayed with the animated effect in the order of  →  → .

NOTE

- Refresh Mode function can only be selected in the cooling and heating modes.
- Smart Mode / Energy Saving Cooling / Refresh Mode functions cannot be set at the same time.
- Some functions may not be supported, depending on the model.

Using the Optional Function

Individual vane angle control (Optional)

This is the function that controls the vane angles individually in the ceiling cassette products.

- 1 Press **VANE ANGLE** button.
 - The individual vane angle control symbol will blink.

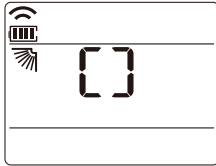

- 2 Set each vane angle by pressing **VANE ANGLE** button.

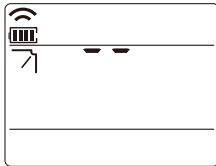

- 3 Press **SET/CLEAR** button to set or cancel this function.

NOTE

- There may be differences between the up/down/left/ right buttons on the wireless remote controller and the wind discharge port directions.
- Set the desired angle while checking the movement and angle of the product's vanes.
- Some functions may not be supported, depending on the model.

Air Purification / Plasma Purification (Optional)

- Press **AIR PURIFY** or **PLASMA** button.
 -  is displayed on the display screen.

NOTE

- If you wish to stop, press **AIR PURIFY** or **PLASMA** button again.
- When **AIR PURIFY** button is pressed while the unit is stopped, Air Purification will start independently.
- Plasma filter is a technology developed by LG to get rid of microscopic contaminants in the intake air by generating a plasma of highly charged electrons. This plasma kills and destroys the contaminants completely to provide clean and hygienic air.
- This function can be used in any operation mode and any fan speed can be used while the plasma filter is functioning.
- Some functions may not be supported, depending on the model.

Smart Indicator (Air Quality) Always On Setting (Optional)

- Press the **AIR PURIFY** button for 3 seconds, Air quality level will always be displayed on Smart Indicator of the product.

NOTE

- Some functions may not be supported, depending on the model.

LCD Luminosity Control (Optional)

It is comfortable when you feel that the display of the unit too bright.

- Press the  button.

Using Special Functions

Setting Special Functions

- 1 Press **FUNC.** button repeatedly to select the desired function.
- 2 Press **SET/CLEAR** button to finish.

NOTE

- Some functions may not be supported, depending on the model.
- Some functions may operate differently from the remote control display.

Canceling Special Functions

- 1 Press **FUNC.** button repeatedly to select the desired function.
- 2 Press **SET/CLEAR** button to cancel the function.

Auto Clean (Optional)

In the Cooling and Dehumidification Mode, moisture is generated inside the indoor unit. This function removes such moisture.

-  is displayed on the display screen.

NOTE

- If you turn off the unit, the fan continues to run for 30 minutes and cleans the inside of the indoor unit.
- Some functions cannot be used while the Auto Clean function is in operation.

Smart Clean (Optional)

The Smart Clean function can be used by setting to manual or automatic.

-  is displayed on the display screen.

Auto Smart Clean Operation

If the accumulated operation time of the product exceeds 30 hours, the Smart Clean automatically starts when the unit is turned off.

Manual Smart Clean Operation

When the unit stop, press the **FUNC.** button to select Smart Clean.

NOTE

- The brush clean a dust from the filter by moving from left to right or from right to left on the filter. The sucked dust is collected into the dust box.
- Some functions may not be supported, depending on the model.

Energy Saving Cooling (Optional)

Energy Saving Cooling is the function to adjust the desired temperature during cooling operation to enhance the comfort of the user and improve the energy saving performance.

-  is displayed on the display screen.

NOTE

- It can be selected only during the cooling operation.
- When pressing Energy Saving Cooling while cooling at 22 °C or lower, it is automatically set to 22 °C.
- During the Energy Saving Cooling operation, the temperature on the remote control may be displayed differently from the air conditioner display.
- Smart Mode / Energy Saving Cooling / Refresh Mode functions cannot be set at the same time.
- Some functions may not be supported, depending on the model.

Electric Heater (Optional)

It can only be set during heating operation.

-  is displayed on the display screen.

NOTE

- The indoor unit displays during the heating mode, the Auxiliary heater is automatically turned on, but it is not displayed on the wireless remote controller separately.
- It operates in Floor heating mode in Console products.
- Heating Mode is not available for Cooling only models.
- Some functions may not be supported, depending on the model.

Comfort Cooling (Optional)

This function is automatically control the cooling strength to maintain the pleasant feeling without turning off the product after the indoor temperature reached the desired temperature.



-  is displayed on the display screen.

NOTE

- It can be selected only during the cooling operation.
- Some functions may not be supported, depending on the model.

Timer Functions

Setting the Current Time

- 1 Press **SET/CLEAR** button for 3 seconds.
- 2 Press  or  button until the desired time is set.
 - If you press down and hold the button for a long time, the time will change more quickly in 10 minute increments.



NOTE

Check the indicator for A.M. and P.M.

Sleep Timer Setting

- 1 Turn the appliance on.
- 2 Press **SLEEP** button to turn the timer on or off.



- 3 Press  or  button until the desired time is set.
 - 7 hours is the maximum setting.
- 4 Press **SET/CLEAR** button.

Setting the On Timer

- 1 Press **ON** button to turn the timer on or off.

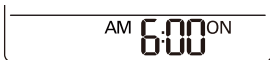

- 2 Press  or  button until the desired time is set.
- 3 Press **SET/CLEAR** button.

Setting the Off Timer

- 1 Press **OFF** button to turn the timer on or off.

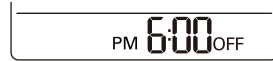

- 2 Press  or  button until the desired time is set.
- 3 Press **SET/CLEAR** button.

Canceling the Timer Setting

You can cancel all timer settings.

- Press **SET/CLEAR** button.

NOTE

- If you wish to cancel a specific timer setting, press the each timer button to turn on or off the Sleep Timer, On Timer, or Off Timer as you want. Then press the **SET/CLEAR** button while aiming the remote controller at the signal receptor.
- The timer lamp on the air conditioner and the display will go off.

Checking the air quality level during air purification operation (Optional)

Press  button for 3 seconds, Air quality level will always be displayed on Smart Indicator of the product.

Global

Display Color	Air Quality Level	Concentration of dust ($\mu\text{g}/\text{m}^3$)	
		PM10	PM2.5/1.0
Green	Good	54 ↓	12 ↓
Yellow	Moderate	55-154	13-35
Orange	Unhealthy	155-254	36-55
Red	Poor	255 ↑	56 ↑

China/India

Display Color	Air Quality Level	Concentration of dust ($\mu\text{g}/\text{m}^3$)	
		PM10	PM2.5/1.0
Green	Good	50 ↓	35 ↓
Yellow	Moderate	51-150	36-75
Orange	Unhealthy	151-250	76-115
Red	Poor	251-350	116-150
Pink	Very poor	351-420	151-250
Violet	Severe	421 ↑	251 ↑



NOTE

- The dust concentration is displayed from 8 to 999 by the unit of 1.
- The dust concentration referred to the data sheet of the sensor manufacturer.
- The dust concentration criteria for the PM1.0 dust were set based on the same criteria as the PM2.5 dust. (Company standard)
- The dust concentration and level displayed on the product may differ from other measuring instruments or other products.
- The displayed dust concentration values can differ from each other depending on the differences in dust measuring methods and also from the actual dust density.
- The dust concentration evaluation is carried out with our company's standard test dust.
- If you use a product generating steam or fine particles (humidifier, cooking appliances, sprays, etc.), the dust concentration may change.
- The dust concentration may vary depending on the installation environment and surrounding environment.
- It is also affected by sofas, beds, carpets, vacuum cleaners, humidity, smoke, bugs, pets, etc.
- It is affected by construction sites, roadsides and factories.
- Dust concentrations can be measured to be higher in an environment where external air is introduced, such as near the entrance, windows and ventilation openings.
- This is an additional function of the product and may not work in some products.
- The feature may be changed according to the type of model.
- Some functions may not be supported, depending on the model.

How to set Air quality level color

- 1 With the  button pressed, press the reset button.



- 2 By using the  or  button, set function code and Setting value.

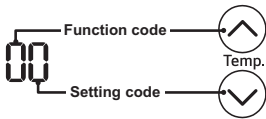

- 3 Press the  button toward the indoor unit 1 time. Each countries have different standards for indicating Overall air quality. Please refer to table below.

Value	Step	Overall Air Quality
Type1 (1beep)	4step (For Korea)	Good/Moderate/Unhealthy/ Poor
Type2 (2beep)	4step (For Global)	Good/Moderate/Unhealthy/ Poor
Type3 (3beep)	6step (For China)	Good/Moderate/Unhealthy/ Poor/ Very Poor/ Severe

- 4 Reset the remote controller to use the general operation mode.

NOTE

- The feature may be changed according to the type of model.
- Some functions may not be supported, depending on the model.

Forced Operation

Operation procedures when the remote control can't be used. Press the tact switch (forced operation) for 2 seconds. If you want to stop operation, press again the tact switch. In case the power comes on again after power failure on the forced operation mode, the operating conditions are automatically set as follows:
During forced operation, the initial mode continues.

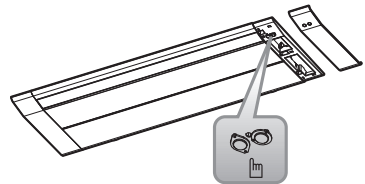

Forced operation
(Tact switch)

Auto Restart Function

In case the power comes on again after a power failure, auto restarting operation is the function to operate procedures automatically to the previous operating conditions.

Maintenance and Service (With Air Purifier)

Cleaning the filter

⚠ CAUTION

Before performing any maintenance, turn off the main power to the system.

1. Pull on the handles on both ends of the marked rear side of the front panel, then open the front grille and press down on the two hooks and remove the Pre-filter.

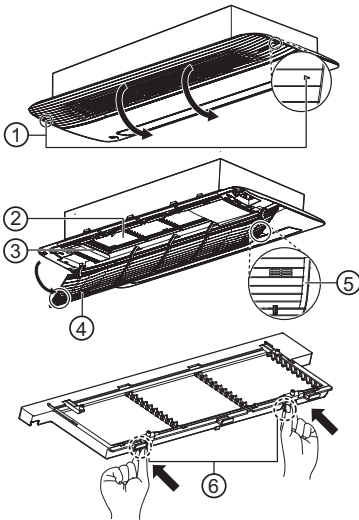

2. Clean with a vacuum cleaner or a soft brush.
 - If the filter is very dirty, wash using water and a neutral detergent.
3. Allow the filter to dry in the shade until completely dry.
4. Install the filter in the reverse order from which it was removed, then close the front grille.
 - When installing the filter, insert the hook in the square hole.

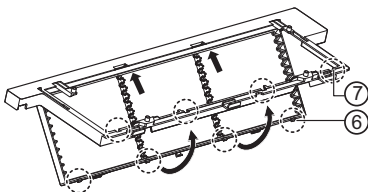

- ① Marker
- ② Pre-filter
- ③ Filter case
- ④ Front intake grille
- ⑤ Handle
- ⑥ Hook
- ⑦ Square hole

⚠ WARNING

For safety, turn off the main power switch.

⚠ CAUTION

- Make sure that the filter is properly installed in the filter case. (When you insert the filter into the case and push the handle, you will hear a clicking sound when it is secured in place.)
- Be careful not to drop the front grille when removing the filter.
- Do not use volatile liquids or water that is 40 °C or hotter.
- Using the filter when it is not completely dry could cause the product to malfunction.
- Drying the filter near a fire or in direct sunlight may cause damage to the filter.
- When cleaning the filter, be careful not to damage the filter's mesh.

NOTE

- If dust gets in the filter, there could be a drop in cooling capacity.
- Clean around once every two weeks.
- If you have the filter cleaned at an LG Electronics Service Center, a separate fee may be charged. (paid service)
- The number and type of filters provided may differ depending on the model.
- Product shape and components may differ depending on the model.
- The feature may be changed according to the type of model.
- Some functions may not be supported, depending on the model.

Cleaning the deodorization filter/PM1.0 filter (Optional)

1. Refer to 'How to Remove the Filter' when removing the filter.
2. Grab the handle on the filter case holder and pull in the direction of the arrow to remove the PM1.0 filter.
 - Do not remove the filter case holder and the intake grille.

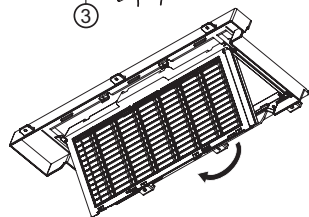
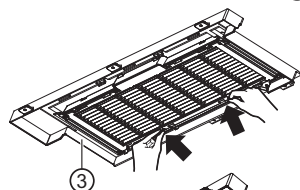
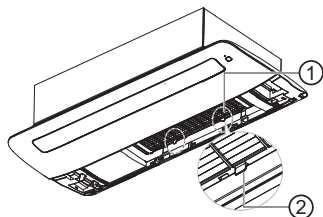

3. As shown in the figure, pull on the handle and remove the deodorization filter.

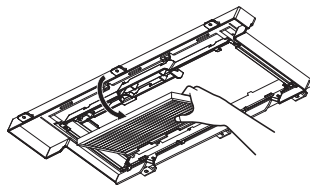
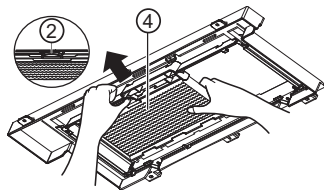

4. Wash the filter after checking the washing method in 'Filter Information'.
5. After washing, reinstall the deodorization filter and the PM1.0 filter to their original positions, respectively.
 - When installing the PM1.0 filter, insert the hook in the square hole.

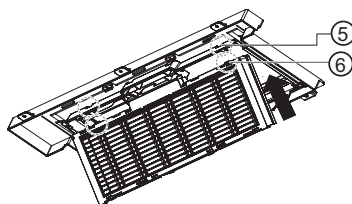

- ① PM1.0 filter
- ② Handle
- ③ Filter case holder
- ④ deodorization filter
- ⑤ Hook
- ⑥ Square hole

⚠ WARNING

For safety, turn off the main power switch.

NOTE

- The feature may be changed according to the type of model.
- Some functions may not be supported, depending on the model.



! CAUTION

- Be careful that the filter case is correctly assembled to the filter holder.
- Be careful not to drop the front grille when removing the filter.
- Do not wash the dust filter with hot water over 40 °C or volatile liquids.
- Do not wash the photocatalytic Deodorization filter in water.
- After cleaning the PM1.0 filter, the buzzer sounds 7 times if the water is not completely dry. Dry the filter thoroughly.
- Drying the filter near a fire or in direct sunlight may cause damage to the filter.
- Wear gloves during installation.

NOTE

- The quantity and type of filters provided by each model may differ.
- The feature may be changed according to the type of model.
- Some functions may not be supported, depending on the model.

Filter Information

Filter Name	Filter Description
Deodorization filter 	<ul style="list-style-type: none"> • Dry for 3 hours in sunlight or under fluorescent light. • It is recommended to clean it every six months. (assuming 8 hours of daily use) • Washing the filter with water could damage or deform it.
PM1.0 filter 	<ul style="list-style-type: none"> • Clean the filter without disassembling it. • Submerge the PM1.0 filter in water, shaking it several times to clean it. • If the filter is very dirty, soak it for 30 minutes in lukewarm water with mild detergent and rinse thoroughly with clean water. (Do not use acidic detergents such as citric acid.) • It is recommended to clean it every six months. • Dry it thoroughly in the shade for about a day. (If there is any remaining moisture, the buzzer will sound 7 times.) Drying with a hot air heater, such as a hair dryer or a heater, could damage or deform the filter. • The inside of the filter is sharp, so do not rub or touch it directly.

Cleaning the PM1.0 Sensor

PM1.0 Sensor

1. As shown in the figure below, put your finger in the indicator.

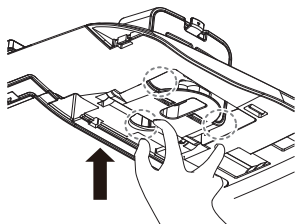

2. Open the front panel and lower the PM1.0 Sensor case as shown in the figure below.

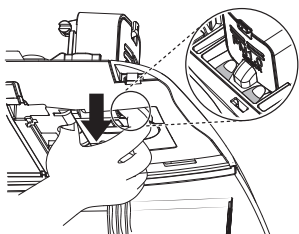

3. Once the PM1.0 Sensor case is lowered all the way, turn the PM1.0 Sensor case to secure it as shown in the figure below.

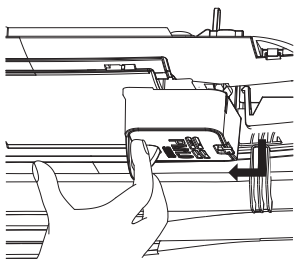

4. Open the PM1.0 sensor cover on the side of the case.

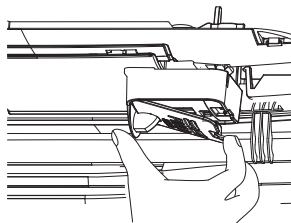

5. Use a slightly wet cotton swab to wipe dust off the lens, and then use a dry swab to remove the moisture.

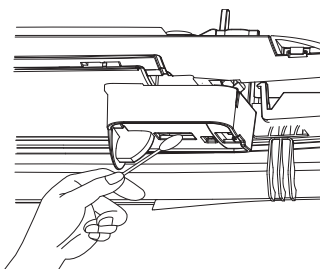

6. Close the PM1.0 Sensor case cover, then install the PM1.0 Sensor case in its original position.

! WARNING

- For safety, turn off the main power switch.
- Be careful not to drop the product when removing the PM1.0 Sensor corner cover.
- Be careful of falling accidents when cleaning the PM1.0 Sensor.

NOTE

- It is recommended to clean it every six months. (assuming 8 hours of daily use)
- PM1.0 Sensor is only included with Air purification panel.
- The feature may be changed according to the type of model.
- Some functions may not be supported, depending on the model.

When the air conditioner is not going to be used for a long time.

When it is not going to be used for a long time.

- 1** Operate the air conditioner at the following settings for 2 to 3 hours.
 - Type of operation: Fan operation mode.
 - This will dry out the internal mechanisms.

- 2** Turn off the breaker.

CAUTION

Turn off the breaker when the air conditioner is not going to be used for a long time.

Dirt may collect and may cause a fire.

Helpful information

The air filters and your electric bill.

If the air filters become clogged with dust, the cooling capacity will drop, and 6 % of the electricity used to operate the air conditioner will be wasted.

When the air conditioner is to be used again.

- 1** Clean the air filter and install it in the indoor unit.

- 2** Check that the air inlet and outlet of the indoor/outdoor unit are not blocked.

- 3** Check that the ground wire is connected correctly. It may be connect to the indoor unit side.

Operation Tips

Do not overcool the room.

This is not good for the health and wastes electricity.

Make sure that the doors and windows are shut tight.

Avoid opening doors and windows as much as possible to keep the cool air in the room.

Keep blinds or curtains closed.

Do not let direct sunshine enter the room when the air conditioner is in operation.

Clean the air filter regularly.

Blockages in the air filter reduce the airflow and lower cooling and dehumidifying effects. Clean at least once every two weeks.

Keep the room temperature uniform.

Adjust the vertical and horizontal airflow direction to ensure a uniform temperature in the room.

Ventilate the room occasionally.

Since windows are kept closed, it is a good idea to open them and ventilate the room now and then.

Before you call for service...



Troubleshooting Tips! Save time and money!

Check the following points before requesting repairs or service.... If the malfunction persist, please contact your dealer.

<p>The air conditioner does not operate.</p> <ul style="list-style-type: none"> • Have you made a mistake in timer operation? • Has the fuse blown or has the circuit breaker been tripped? 	<p>The room has a peculiar odor.</p> <ul style="list-style-type: none"> • Check that this is not a damp smell exuded by the walls, carpet, furniture or cloth items in the room. 	<p>It seems that condensation is leaking from the air conditioner.</p> <ul style="list-style-type: none"> • Condensation occurs when the airflow from the air conditioner cools the warm room air. 	<p>Air conditioner does not operate for about 3 minutes when restart.</p> <ul style="list-style-type: none"> • This is the protector of the mechanism. • Wait about three minutes and operation will begin.
<p>Does not cool or heat effectively.</p> <ul style="list-style-type: none"> • Is the air filter dirty? See air filter cleaning instructions. • The room may have been very hot when the room air conditioner was first turned on. Allow time for it to cool down. • Has the temperature been set incorrectly? • Are the indoor unit's air inlet or outlet vents obstructed? 	<p>The air conditioner operation is noisy.</p> <ul style="list-style-type: none"> • For a noise that sounds like water flowing. <ul style="list-style-type: none"> -This is the sound of freon flowing inside the air conditioner unit. • For a noise that sounds like the compressed air releasing into atmosphere. <ul style="list-style-type: none"> -This is the sound of the dehumidifying water being processed inside the air conditioning unit. 	<p>Crack sound is heard.</p> <ul style="list-style-type: none"> • This sound is generated by the expansion/ constriction of the front panel, etc. due to changes of temperature. <p>Remote control display is faint, or no display at all.</p> <ul style="list-style-type: none"> • Are the batteries depleted? • Are the batteries inserted in the opposite (+) and (-) directions? 	<p>The buzzer sounds. (7 times)</p> <ul style="list-style-type: none"> • Is the suction panel completely closed? Close the suction grille completely. • Is the water completely dried after cleaning the PM1.0 filter? If moisture remains, let it dry in the shade for about a day. • Is the PM1.0 filter film torn? Contact the LG Electronics Service Center.

NOTE

WATER RESISTANT: The outdoor side of this appliance is WATER RESISTANT. The indoor side is not water resistant and should not be exposed to excess water.

Model	Voltage / Hz	Current(A)
AMNW09GTUC0	220 V~ 60 Hz	0.2
AMNW12GTUC0	220 V~ 60 Hz	0.2



Model / Modelo (s) :

AMNW09GTUC0 / AMNW12GTUC0

LG Electronics México, S.A de C.V
Sor Juana Inés de la Cruz No. 555
Col. San Lorenzo Industrial
Tlalnepantla de Baz Estado de México C.P. 54033
Tel. 55 5321 1919
Página web <http://www.lg.com/mx>

NOM