



Scan the QR code to see the manual.



OWNER'S MANUAL

# FRIDGE & FREEZER

---



Before beginning installation, read these instructions carefully. This will simplify installation and ensure that the product is installed correctly and safely. Leave these instructions near the product after installation for future reference.

**ENGLISH**



MFL72119811  
Rev.02\_121225

[www.lg.com](http://www.lg.com)

Copyright © 2025 LG Electronics. All Rights Reserved

# TABLE OF CONTENTS

This manual may contain images or content that may be different from the model you purchased.  
This manual is subject to revision by the manufacturer.

## SAFETY INSTRUCTIONS

READ ALL INSTRUCTIONS BEFORE USE..... 4  
WARNING ..... 4  
CAUTION ..... 10  
CARING FOR THE ENVIRONMENT ..... 12

## INSTALLATION

Before Installation ..... 15  
Removing the Fridge and Freezer Door ..... 16  
Levelling and Door Alignment..... 18  
Turning on the Power ..... 20  
Moving the Appliance for Relocation ..... 20

## OPERATION

Before Use ..... 22  
Product Features..... 24  
Control Panel ..... 27  
InstaView..... 28  
Icemaker ..... 29  
Drawer ..... 30  
Shelf ..... 32  
Door Basket ..... 33

## SMART FUNCTIONS

LG ThinQ Application ..... 34  
Smart Diagnosis ..... 35

## MAINTENANCE

Cleaning ..... 37

## TROUBLESHOOTING

Before Calling for Service..... 38

## APPENDIX

Information.....	43
Warranty .....	43

## SAFETY INSTRUCTIONS

### READ ALL INSTRUCTIONS BEFORE USE

The following safety guidelines are intended to prevent unforeseen risks or damage from unsafe or incorrect operation of the appliance.

The guidelines are separated into **'WARNING'** and **'CAUTION'** as described below.

### Safety Messages



This symbol is displayed to indicate matters and operations that can cause risk. Read the part with this symbol carefully and follow the instructions in order to avoid risk.



#### **WARNING**

This indicates that the failure to follow the instructions can cause serious injury or death.



#### **CAUTION**

This indicates that the failure to follow the instructions can cause the minor injury or damage to the product.

### WARNING

---

#### **WARNING**

To reduce the risk of explosion, fire, death, electric shock, injury or scalding to persons when using this product, follow basic precautions, including the following:

---

### Technical Safety

- This appliance is not intended for use by persons (including children) with reduced physical, sensory or mental capabilities, or lack of experience and knowledge, unless they have been given supervision or instruction concerning use of the appliance by a person

responsible for their safety. Children should be supervised to ensure that they do not play with the appliance.

- This appliance is intended to be used in household and similar applications such as:
  - staff kitchen areas in shops, offices and other working environments;
  - farm houses and by clients in hotels, motels and other residential type environments;
  - bed and breakfast type environments;
  - catering and similar non-retail applications.
- This refrigerating appliance is not intended to be used as a built-in appliance.
- This appliance is not for use in portable or mobile installations, such as marine or RV uses, where it will be in motion while operating.



This symbol alerts you to flammable materials that can ignite and cause a fire if you do not take care.

- This appliance contains a small amount of isobutane refrigerant (R600a), but it is also combustible. When transporting and installing the appliance, care should be taken to ensure that no parts of the refrigerating circuit are damaged.
- The refrigerant and insulation blowing gas used in the appliance require special disposal procedures. Consult with service agent or a similarly qualified person before disposing of them.
- Do not damage the refrigerant circuit.
- If the power cord is damaged or the hole of the outlet socket is loose, it must be replaced. Do not use the power cord and contact an authorized service centre in order to avoid a hazard.
- Do not locate multiple portable socket-outlets or portable power supplies at the rear of the appliance.
- Securely plug the power plug in the outlet socket after completely removing any moisture and dust.

- Never unplug the appliance by pulling on the power cable. Always grip the power plug firmly and pull straight out from the outlet socket.
- Keep ventilation openings, in the appliance enclosure or in the built-in structure, clear of obstruction.
- Do not store explosive substances such as aerosol cans with a flammable propellant in this appliance.
- Do not tilt the appliance to pull or push it when transporting.
- When positioning the appliance, ensure the supply cord is not trapped or damaged.
- Do not use mechanical devices or other means to accelerate the defrosting process.
- Do not use a hair drier to dry the inside of the appliance or place a candle inside to remove the odours.
- Do not use electrical appliances inside the food storage compartments of the appliance, unless they are of the type recommended by the manufacturer.
- Make sure not to get a body part such as a hand or foot stuck while moving the appliance.
- Disconnect the power cord before cleaning the appliance interior or exterior.
- Do not spray water or inflammable substances (toothpaste, alcohol, thinner, benzene, flammable liquid, abrasive, etc.) over the interior or exterior of the appliance to clean it.
- Do not clean the appliance with brushes, cloths or sponges with rough surfaces or which are made of metallic material.
- Only qualified service personnel from LG Electronics service centre should disassemble, repair, or modify the appliance. Contact an LG Electronics customer information centre if you move and install the appliance in a different location.

### **Risk of Fire and Flammable Materials**

- If a leak is detected, avoid any naked flames or potential sources of ignition and air the room in which the appliance is standing for

several minutes. In order to avoid the creation of a flammable gas air mixture if a leak in the refrigerating circuit occurs, the size of the room in which the appliance is used should correspond to the amount of refrigerant used. The room must be 1 m<sup>2</sup> in size for every 8 g of R600a refrigerant inside the appliance.

- Refrigerant leaking out of the pipes could ignite or cause an explosion.
- The amount of refrigerant in your particular appliance is shown on the identification plate inside the appliance.

## Installation

- This appliance should only be transported by two or more people holding the appliance securely.
- Install the appliance on a firm and level floor.
- Do not install the appliance in a damp and dusty place. Do not install or store the appliance in any outdoor area, or any area that is subject to weathering conditions such as direct sunlight, wind, rain, or temperatures below freezing.
- Do not place the appliance in direct sunlight or expose it to the heat from heating appliances such as stoves or heaters.
- Be careful not to expose the rear of the appliance when installing.
- Install the appliance in a place where it is easy to unplug the power plug of the appliance.
- Be careful not to let the appliance door fall during assembly or disassembly.
- Be careful not to pinch, crush, or damage the power cable during assembly or disassembly of the appliance door.
- Be careful not to point the power plug up or let the appliance lean against the power plug.
- Do not connect a plug adapter or other accessories to the power plug.
- Do not modify or extend the power cable.

- Ensure that the outlet socket is properly grounded, and that the earth pin on the power cord is not damaged or removed from the power plug. For more details on grounding, inquire at an LG Electronics customer information centre.
- This appliance is equipped with a power cord having an equipment-grounding conductor and a grounding power plug. The power plug must be plugged into an appropriate outlet socket that is installed and grounded in accordance with all local codes and ordinances.
- Never start up an appliance showing any signs of damage. If in doubt, consult your dealer.
- Dispose of all packaging materials (such as plastic bags and styrofoam) away from children. The packaging materials can cause suffocation.
- Do not plug the appliance into a multi socket adapter which does not have a power cable (mounted).
- The appliance should be connected to a dedicated power line which is separately fused.
- Do not use a multi socket outlet which is not properly grounded (portable). In case of using a properly-grounded multi socket outlet (portable), use the multi socket outlet with the current capacity of the power cord rating or higher and use the multi socket outlet only for the appliance.

### **Operation**

- Do not use the appliance for any purpose (storage of medical or experimental materials or shipping) other than any domestic household food storage use.
- If water penetrates electrical parts of the appliance, disconnect power plug and contact an LG Electronics customer information centre.
- Unplug the power plug during a severe thunderstorm or lightning or when not in use for a long period of time.
- Do not touch the power plug or the appliance controls with wet hands.

- Do not bend the power cable excessively or place a heavy object on it.
- Immediately unplug the power plug and contact an LG Electronics customer information centre if you detect a strange sound, odour, or smoke coming from the appliance.
- Do not place hands or metallic objects inside the area emitting the cold air, cover or heat releasing grille on the back.
- Do not apply excessive force or impact to the back cover of the appliance.
- Be careful of nearby children when you open or close the appliance door. The door may bump the child and cause injury.
- Avoid the danger of children getting trapped inside the appliance. A child trapped inside the appliance can cause suffocation.
- Do not put animals, such as pets into the appliance.
- Do not place heavy or fragile objects, containers filled with liquid, combustible substances, flammable objects (such as candles, lamps, etc.), or heating devices (such as stoves, heaters, etc.) on the appliance.
- Do not place any electronic appliance (such as heater and mobile phone) inside the appliance.
- If there is a gas leakage (isobutane, propane, natural gas, etc.), do not touch the appliance or power plug and ventilate the area immediately. This appliance uses a refrigerant gas (isobutane, R600a). Although it uses a small amount of the gas, it is still combustible gas. Gas leakage during appliance transport, installation or operation can cause fire, explosion or injury if sparks are caused.
- Do not use or store flammable or combustible substances (ether, benzene, alcohol, chemical, LPG, combustible spray, insecticide, air freshener, cosmetics, etc.) near the appliance.
- This appliance incorporates an earth connection for functional purposes.
- Connect to potable water supply only.
  - If connected to a water supply, connect to a potable water supply only.
- Fill with potable water only.

- If using an icemaker or dispenser water tank, make sure to fill it with potable water only.

### **Disposal**

- When discarding the appliance, remove the door gasket while leaving the shelves and baskets in place and keep children away from the appliance.

### **CAUTION**

---

#### **CAUTION**

To reduce the risk of minor injury to persons, malfunction, or damage to the product or property when using this product, follow basic precautions, including the following:

---

### **Installation**

- After unpacking, check the appliance for any damage that may have occurred during transit.
- Wait for at least 3 to 4 hours in order to ensure the refrigerant circuit is fully efficient.
- Move the appliance carefully on sensitive floors to avoid damage to the floor.

### **Operation**

- Do not touch frozen food or the metal parts in the freezer compartment with wet or damp hands. It may cause frostbite.
- Do not place glass containers, bottles or cans (especially those containing carbonated drinks) in the freezer compartment, shelves or ice bucket that will be exposed to temperatures below freezing.
- The tempered glass on the front side of the appliance door or the shelves can be damaged by an impact. If it is broken, do not touch it with hands.

- Do not hang from the appliance doors, storage room, shelf or climb up into it.
- Do not store an excessive amount of water bottles or containers for side dishes on the door baskets.
- Do not open or close the appliance door with excessive force.
- If the hinge of the appliance door is damaged or operates improperly, stop using the appliance and contact an authorized service centre.
- Prevent animals from nibbling on the power cable or water hose.
- Never eat frozen foods immediately after they have been taken out in the freezer compartment.
- Make sure not to get a hand or foot stuck upon opening or closing the appliance door or door in door.

## Maintenance

- This appliance is equipped with maintenance-free LED interior light. Do not remove cover or LED lamp in any attempt to repair or change it. Contact an LG Electronics customer information centre.
- Do not clean glass shelves or covers with warm water when they are cold. They may shatter if exposed to sudden temperature changes.
- Do not insert the shelves upside down. The shelves may fall.
- To remove frost from the appliance, contact an LG Electronics customer information centre.
- Dispose of the ice inside the ice bucket in the freezer compartment during an extended power outage.

## CARING FOR THE ENVIRONMENT

### Disposal of Your Old Appliance (as per e-waste Rules)



1. When this crossed out wheeled bin symbol is depicted on the product and its operator's manual, it means the product is covered by E-Waste Management Rules India published by MoEF & CC, Govt. of India and are meant to be recycled, dismantled, refurbished or disposed off.

#### 2. Do's

- a. The product is required to be handed over only to the authorized recycler for disposal.
- b. Keep the product in isolated area, after it becomes non-functional/unreparable so as to prevent its accidental breakage.

#### Don'ts

- a. The product should not be opened by the user himself/herself, but only by authorized service personnel.
- b. The product is not meant for re-sale to any unauthorized agencies/scrap dealer/kabariwalah.
- c. The product is not meant for mixing into household waste stream.
- d. Do not keep any replaced spare part(s) from the product in exposed area.

3. Any disposal through unauthorized agencies/person will attract action under Environment (Protection) Act 1986.

#### 4. Hazards of improper handling or accidental breakage :

- a. The refrigerant (R134a) used, if overexposed, might cause dizziness and loss of concentration. Liquid contact can cause irritation and frostbite. The refrigerant (R600a), squirting out of the pipes could ignite or cause eye injury.
- b. The blowing agent cyclopentane is highly flammable liquid and vapor. Harmful to aquatic life. Contact with liquid may cause cold burns/frost bites. Repeated exposure causes skin dryness.

5. This product is complied with the requirement of Hazardous Substances as specified under E-Waste Management Rules India published by MoEF & CC , Govt. of India.

6. To locate a nearest collection centre or call for pick-up (limited area only) for disposal of this appliance, please contact No. 08069379999, Toll Free No. 1800-315-9999 for details. All collection centre and pick up facilities are done by third parties with LG Electronics India Ltd. Merely as a facilitator. For more detailed information, please visit : <http://www.lg.com/in>.

## अपने पुराने उपकरण का निपटान (ई- अपशिष्ट नियमों के अनुसार)



1. जब इस काटे गए पहिये वाले बिन का चिह्न किसी उपकरण और इसके ऑपरेटर और उसके ऑपरेटर की पुस्तिका के साथ संलग्न होता है, तो इसका मतलब है कि इसे "ई-अपशिष्ट" (प्रबंधन और हथालन) नियम के अंतर्गत सम्मिलित किया गया है और इसके पुनर्नवीनीकरण, नवीनीकरण, विघटन और निपटान के लिए बनाया गया है। MoEF & CC भारत सरकार द्वारा प्रकाशित (भारतीय "ई- अपशिष्ट" (प्रबंधन और हथालन))

2. करें

क. उपकरण को सिर्फ अधिकृत पुनः नवीनीकरणकर्ता को ही निपटारन करने हेतु हस्तांतरित करें।

ख. जब उपकरण कार्यरत ना हो, इसे अलग क्षेत्र में रखें ताकि उपकरण से होने वाली दुर्घटनाओं से बचा जा सके।

ना करें

क. इस उपकरण को स्वयं उपयोगकर्ता द्वारा नहीं खोला जाना चाहिए, बल्कि केवल अधिकृत सेवा कर्मियों द्वारा ही खोला जाना चाहिए।

ख. इस उपकरण को पुनः बिक्री के लिए किसी भी अनधिकृत संस्था /भंगार वाला /कबाड़ीवाला को ना दे।

ग. इस उपकरण को किसी घरेलू अपशिष्ट सामान के साथ मिलाकर ना रखें।

घ. उपकरण के बदले हुए या आंतरिक पुरजो को खुले क्षेत्र में न रखें।

3. यदि किसी अनधिकृत विभाग या व्यक्ति के द्वारा निपटारन किया जाता है तो यह पर्यावरण (सुरक्षा) अधिनियम 1986 के अंतर्गत आता है।

4. यह उत्पाद ई- अपशिष्ट (प्रबंधन और हथालन) नियम के तहत निर्दिष्ट खतरनाक पदार्थों की आवश्यकता का पालन करता है।

MoEF & CC, भारत सरकार द्वारा प्रकाशित (भारतीय "ई- अपशिष्ट" (प्रबंधन और हथालन))

5. उपरोक्त पदार्थों के निपटारन के लिए नजदीकी निपटारन संस्थान (संकीर्ण क्षेत्र) में कॉल करें। अधिक जानकारी के लिए हमारे नंबर **08069379999**, टोल फ्री नंबर **1800-315-9999** पर पर कॉल करें। सभी संग्रहण केंद्र व पिक-अप की सुविधाएं किसी थर्ड -पार्टी जो "LG Electronics India Ltd." को अपनी सेवाएं प्रदान कर रही हों से करवाएं।

अधिक जानकारी के लिए, कृपया देखें वेब साइट : <http://www.lg.com/in>

# INSTALLATION

## Before Installation

### Dimensions and Clearances

Too small of a distance from adjacent items may result in the degradation of freezing capability and increased electricity costs. Allow over 50 mm of clearance between the back of the appliance and the wall when installing the appliance.

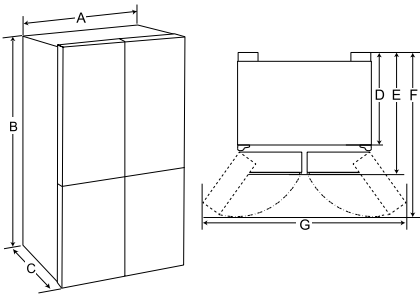

-	Size (mm)	
	Type A	Type B
A	835	
B	1860	1777
C	736	
D	635	
E	736	
F	1057	
G	1290	

### NOTE

- You can determine what type of appliance it is by looking at the label inside the appliance.

## Ambient Temperature

- The appliance is designed to operate within a limited range of ambient temperatures, depending on the climate zone.
- The internal temperatures could be affected by the location of the appliance, the ambient temperature, the frequency of door opening and so on.
- The climate class can be found on the rating label.

Climate Class	Ambient Temperature Range °C
SN (Extended Temperate)	+10 - +32
N (Temperate)	+16 - +32
ST (Subtropical)	+16 - +38 / +18 - +38**
T (Tropical)	+10 - +43* / +16 - +43 / +18 - +43**

\* Australia, India, Kenya

\*\* Argentina

### NOTE

- The appliances rated from SN to T are intended to be used at an ambient temperature between 10 °C and 43 °C.

## Accessories

\*1 This feature is only available on some models.



1 Spanner\*1

2 C-Clip (Snap Ring)\*1

## Removing the Fridge and Freezer Door

If your entrance door is too narrow for the appliance to pass through, remove the appliance doors and pass the appliance laterally.

### ⚠ WARNING

- Disconnect the power cord, house fuse or circuit breaker before installing, removing the doors, or cleaning the appliance. Failure to follow these instructions may result in death, fire or electric shock.

## Removing the Hinge Cover

Remove the screws from the hinge cover at the top of the appliance. Lift the hook (not visible), located at the bottom of the front side of the cover with a flat-head screwdriver.

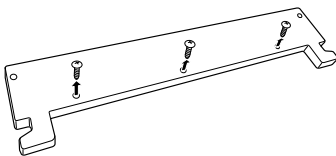

## Removing the Left Fridge Door

- 1 Disconnect all wire harnesses 1. Unscrew the ground wire 2.

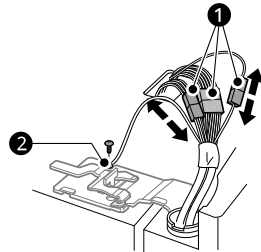

### NOTE

- The number of wire harnesses may vary depending on the model.

- 2 Rotate the hinge lever 3 counterclockwise. Lift the top hinge 4 free of the hinge lever latch 5.

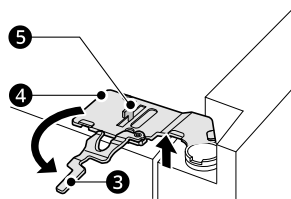

### ⚠ CAUTION

- When lifting the hinge free of the latch, be careful that the door does not fall forward. It is recommended that two or more people carry out the door removal and refitting.

- 3 Lift the left fridge door until it is free of the middle hinge assembly.

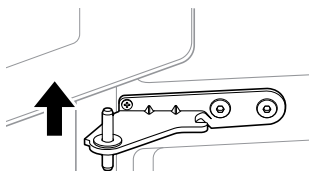

### ⚠ CAUTION

- Place the door on a non-scratching surface with the inner side facing up.

- 2 Rotate the hinge lever 3 clockwise. Lift the top hinge 4 free of the hinge lever latch 5.

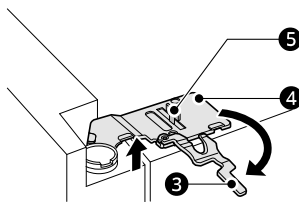

### ⚠ CAUTION

- When lifting the hinge free of the hinge lever latch, be careful that the door does not fall forward. It is recommended that two or more people carry out the door removal and refitting.

## Removing the Right Fridge Door

- 1 Disconnect all wire harnesses 1. Unscrew the ground wire 2.

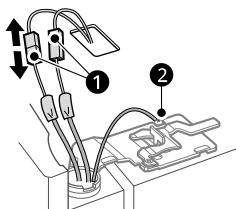

### NOTE

- The number of wire harnesses may vary depending on the model.
- Ground wire is only present on some model

- 3 Lift the right fridge door until it is free of the middle hinge assembly.

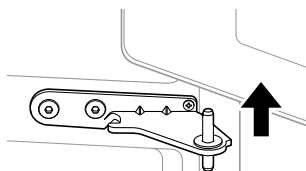

### ⚠ CAUTION

- Place the door on a non-scratching surface with the inner side facing up.

## Removing the Freezer Door

- 1 Remove the two hinge bolts.

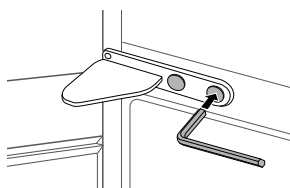

## 18 INSTALLATION

- 2** Twist the hinge to raise the pivoting end so that the door can be lifted off. Lift the door off the lower hinge pin and remove it.

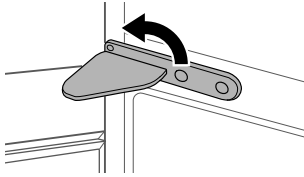

- 3** Remove the door by lifting it off the lower hinge pin.

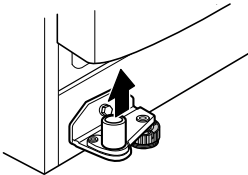

## Refitting the Fridge and Freezer Door

Refit the doors in the reverse sequence of their removal once the appliance has been passed through all access doors.

## Levelling and Door Alignment

### Before Beginning

When the appliance doors appear to be uneven, follow the instructions below to align the doors.

### NOTE

- The spanner may differ depending on the model. You will be provided with one of the available spanners.

- Spanner Type A

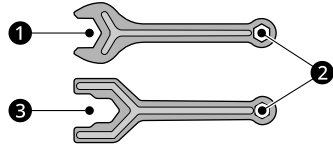

- Spanner Type B

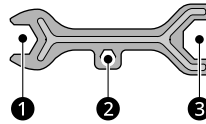

- Spanner Type C

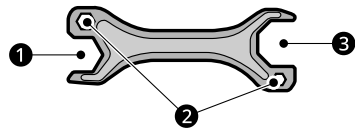

- Spanner Type D

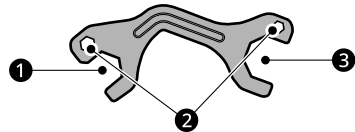

## Levelling the Appliance

The appliance has two front levelling legs. Adjust the legs to alter the tilt from front to back or side to side. If the appliance seems unsteady, or the doors do not close easily, adjust the appliance's tilt using the instructions below.

It is quite normal for the appliance to have a backward lean even when the front legs are turned all the way.

Use the spanner ❶ to adjust the height by turning the levelling leg to the left to raise it or to the right to lower it.

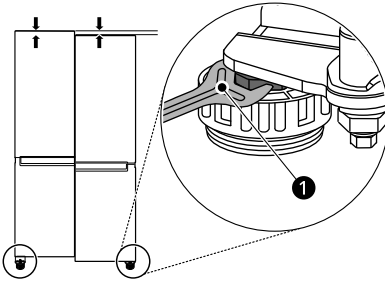

2 Use the spanner ❷ to adjust the height by turning the adjustment hinge pin to the left or to the right.

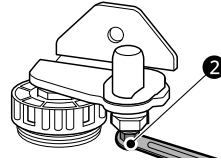

**⚠ CAUTION**

- Do not adjust the height of the appliance door more than 3 mm.

**Door Alignment for Freezer Door**

If the door of the appliance is not level, adjust the difference in the height of appliance door.

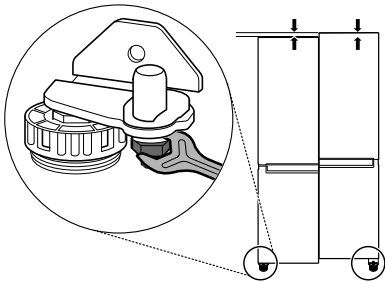

1 Open the door and use the spanner ❶ to loosen the keeper nut by turning it to the left.

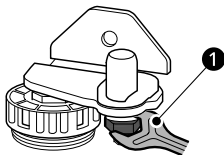

3 Use the spanner ❶ to fasten the keeper nut by turning it to the right.

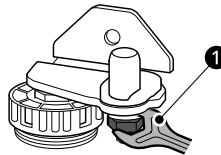

**NOTE**

- Levelling the doors may not be possible when the floor is not level, or is of weak or poor construction.
- The refrigerator is heavy and should be installed on a rigid, flat and solid surface.
- Some timber flooring may cause levelling difficulties if it flexes excessively.

### Door Alignment for Left Fridge Door

Open the fridge door and use the spanner ③ to rotate the door hinge bolt.

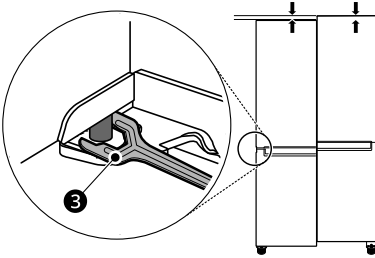

### Door Alignment for Right Fridge Door

Adjust the left fridge door first. If the door is too low, lift the right door up and use a pair of long nose pliers to insert C-Clips until both doors are level.

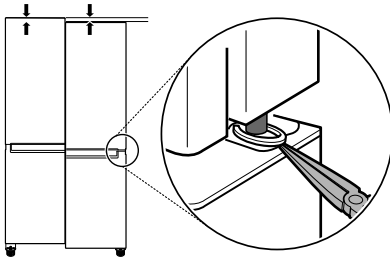

## Turning on the Power

### Connecting the Appliance

To turn on the appliance, connect the power plug into the outlet socket. Do not double up with other appliances on the same outlet.

#### NOTE

- After connecting the power supply cord (or plug) to the outlet, wait enough time before you put

food into the appliance. If you add food before the appliance has cooled completely, your food may spoil. Make sure you have removed any clear protective film where it has been applied to the door.

- To turn off the appliance, disconnect the power plug from the outlet socket.

## Moving the Appliance for Relocation

### Moving the Appliance

- 1 Remove all food from inside the appliance.
- 2 Fix the power plug.
  - Models with a power plug hook:  
Pull the power plug out, insert and fix it into the power plug hook at the rear or on top of the appliance.
  - Models without a power plug hook:  
Pull the power plug out and fix the power supply cable with a tape to the side of the appliance where the power socket is located at the installation site.
- 3 Tape parts such as shelves and the door handle to prevent from falling off while moving the appliance.
- 4 Move the appliance with more than two people carefully. When transporting the appliance over a long distance, keep the appliance upright.

### ⚠ CAUTION

- Move the appliance carefully on sensitive floors to avoid damage to the floor.
- Use cardboard, floor mat or carpet to prevent scratches on the floor when installing or moving the appliance.

- Do not move the appliance in zigzags.

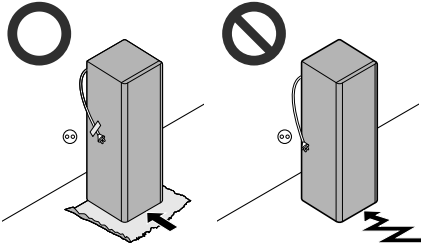

- 5 After installing the appliance, connect the power plug into a mains outlet socket and switch it on.

# OPERATION

## Before Use

### Notes for Operation

- Users should keep in mind that frost can form if the door is not closed completely or if the humidity is high during the summer.
- Ensure there is sufficient space between food stored on the shelf or door basket to allow the door to close completely.
- Opening the door for long periods can cause a significant increase of the temperature in the compartments of the appliance.
- If the refrigerating appliance is left empty for long periods, switch off, defrost, clean, dry, and leave the door open to prevent mould developing within the appliance.
- Note that a temperature rise after defrosting has a permissible range in the appliance specifications. If you wish to minimise the impact on the food storage due to a temperature rise, seal or wrap the stored food in several layers.

## Door Open Alarm

This feature is only available on some models. The alarm sounds if the door is left open or not completely closed.

---

### NOTE

- Contact the LG Electronics customer information centre if the alarm sound continues even after closing all doors.
- 

## Failure Detection

The appliance can automatically detect problems during the operation.

---

### NOTE

- If a problem is detected, the appliance may not operate and an error code is displayed even when any button is pressed.

- If an error code is indicated on the display, do not turn off the power. Immediately contact the LG Electronics customer information centre and report the error code. If you turn off the power, the repair technician from the our information centre may have difficulty finding the problem.
- 

## Suggestion for Energy Saving

- For the most efficient use of energy, keep all inner parts (e.g. door baskets, drawers and shelves) on their original location. Altering their positions may result in less efficient energy consumption or performance.
- Ensure there is sufficient space between stored foods. This allows cold air to be circulated evenly and lowers electricity bills.
- Store hot food only after it has cooled in order to prevent dew or frost.
- When storing food in the freezer compartment, set the freezer temperature lower than the temperature indicated on the food.
- Do not set the temperature of the appliance lower than needed.
- Do not put food near the temperature sensor of the fridge compartment. Keep a distance of at least 3 cm from the sensor.

## Storing Foods Effectively

- Food may freeze or spoil if stored at the wrong temperature. Set the refrigerator to the correct temperature for the food being stored.
- Store frozen food or refrigerated food inside sealed containers.
- Check the expiration date and label (storage instructions) before storing food in the appliance.
- Do not store food for a long period of time if it spoils easily at a low temperature.
- Do not place unfrozen food in direct contact with food that is already frozen. It could be necessary

to reduce the quantity to be frozen if freezing every day is anticipated.

- Place the refrigerated food or frozen food in each fridge or freezer compartment immediately after purchasing.
- Store raw meat and fish in suitable containers in the refrigerator, so that it is not in contact with or drip onto other food.
- Refrigerated foods and other food items can be stored on top of the vegetable drawer.
- Avoid refreezing any food which has been completely thawed. Freezing any food which has been completely thawed again will lower its taste and nutrition.
- Do not overfill the appliance. Cold air can not circulate properly if the appliance is overfilled.
- Cool hot food before storing. If too much hot food is placed inside, the internal temperature of the appliance can increase and negatively affect other foods stored in the appliance.
- If you set an excessively low temperature for food, it may become frozen. Do not set a temperature lower than the required temperature for the food to be stored correctly.
- If there are chill compartments in the appliance, do not store vegetables and fruits with higher moisture content in the chill compartments as they may freeze due to the lower temperature.
- In the event of a blackout, call the electricity company and ask how long it is going to last.
  - You should avoid door openings while the power is off.
  - When the power supply gets back to normal, check the condition of the food.

- To freeze food items quickly, store the food in the front of the right side tray and drawer. Food items will freeze most quickly in the zone.
- To get better air circulation, insert all inner parts like baskets, drawers, and shelves.

## Freezing the Maximum Amount of Food

If large quantities of food are to be stored, all the freezer drawers should be taken out of the appliance except the bottom one and the food should be stacked directly on the freezer shelves in the freezer compartment.

### CAUTION

- To remove the drawers, first remove the food from drawers and then pull out the drawers carefully. Not doing so could cause injury or damage to the drawers.

### NOTE

- The shape of each drawer may be different, insert in the right position.

## Maximum Freezing Capacity

- For maximum freezing capacity, set the freezer temperature to the coldest temperature setting.
- **Express Freeze** function will allow the freezer to reach its maximum freezing capacity. This generally takes up to 24 hours and automatically switches off.
- **Express Freeze** must be switched on for 3 hours before fresh products are placed in the freezer compartment.

### Product Features

The appearance or components of the appliance may differ from model to model.

### Exterior

\*1 This feature is only available on some models.

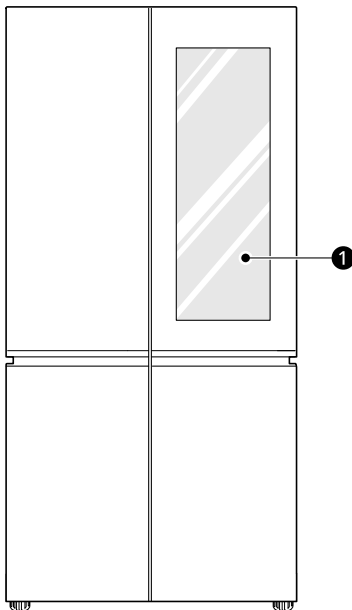

#### 1 InstaView<sup>\*1</sup>

Knock twice on the glass to turn the LED light inside the **InstaView** on or off.

## Interior

\*1 This feature is only available on some models.

### Standard Door Model:

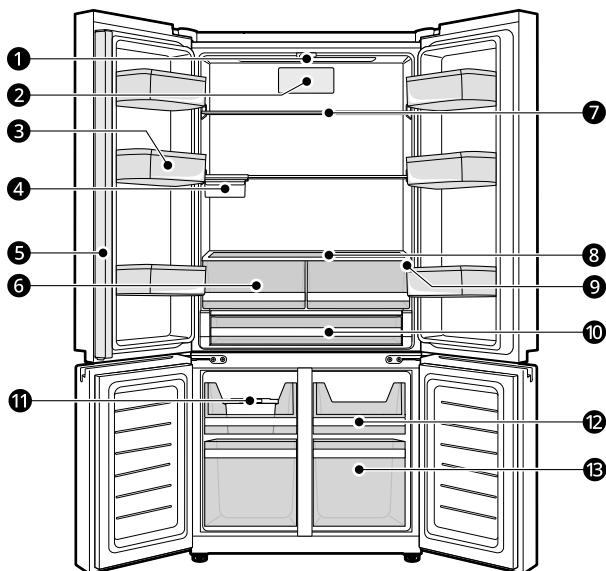

### InstaView Model:

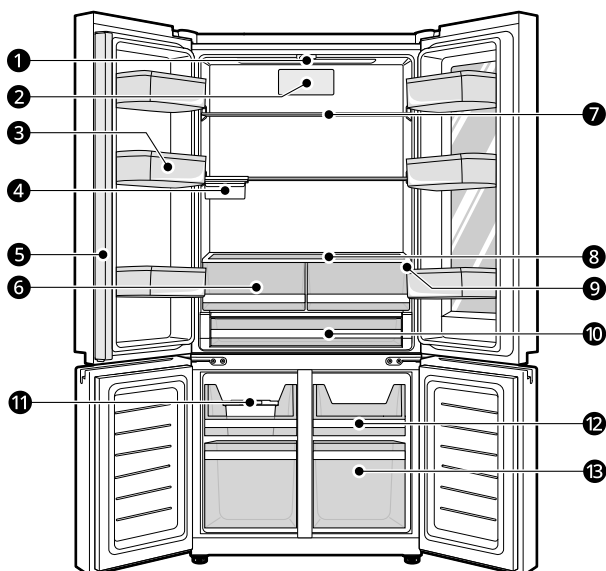

### ① LED Lamp

The LED lamps inside the fridge light up when you open the door.

### ② Air Filter

Reduces odours inside the fridge compartment.

### ③ Fridge Door Basket

Stores small packages of refrigerated foods, drinks and sauce containers.

### ④ Fresh Tray\*<sup>1</sup>

You can store leftover ingredients or a small amount of ingredients.

### ⑤ Door Mullion

Prevents the cold air of the fridge from leaking.

---

## ⚠ CAUTION

- To reduce the risk of scratching the door or breaking the center door mullion, make sure that the refrigerator door mullion is always folded in.
- 

### ⑥ Fridge Drawer

Keeps fruits and vegetables fresh.

### ⑦ Fridge Shelf

Stores refrigerated foods and fresh foods.

Stores the foods with higher moisture content at the front of the shelf.

The shelf height can be adjusted by inserting the shelf in another groove of different height.

### ⑧ Bottom Shelf

To store a food container that is greater than 1 kg, place it on the bottom shelf.

### ⑨ Control Panel

Sets the fridge temperature and freezer temperature.

### ⑩ Pantry Drawer

Stores food items at a different temperature than the regular fridge area.

### ⑪ Icemaker

This is where ice is produced and stored.

---

## NOTE

- The location of the icemaker may vary depending on the model.
- 

### ⑫ Freezer Tray

Stores small packaged frozen food or frequently-used foods. The sliding trays allow easy access and convenience of use.

### ⑬ Freezer Drawer

Stores frozen food for longer storage.

# Control Panel

The actual control panel may differ from model to model.

## Control Panel and Functions

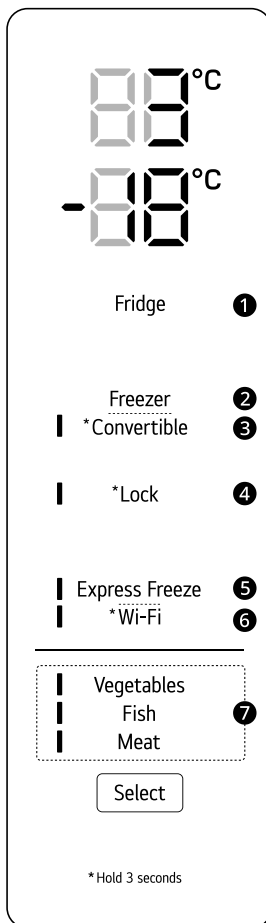

### 1 Fridge

Press this button repeatedly to select a desired temperature between 1 °C and 7 °C.

- The default fridge temperature is 3 °C.

### 2 Freezer

Press this button repeatedly to select a desired temperature between -23 °C and -15 °C.

- The default freezer temperature is -18 °C.

### 3 Convertible

This function allows you to use the freezer compartment as a fridge.

- Press and hold the button for 3 seconds to activate or deactivate this function.
- When the **Convertible** function is activated, the temperature of the freezer is set to 3 °C
- When the **Convertible** function is activated, the Pantry Drawer in the fridge automatically switches to **Vegetables** mode and cannot be set to other modes until the **Convertible** function is deactivated.
- Before activating the **Convertible** function, remove any food items from the freezer that require freezing.

### ④ Lock

This locks buttons on the control panel.

- To lock the control panel buttons, press and hold the **Lock** button for 3 seconds until indicator light turns on and the function is activated.
- To disable the function, press and hold the **Lock** button for 3 seconds until the indicator light turns off and the function is deactivated.

### ⑤ Express Freeze

This function can quickly freeze a large amount of ice or frozen foods.

- This function is enabled and disabled in turn each time you press the button.
- This function automatically terminates after a specific period has passed.

### ⑥ Wi-Fi

This button allows the appliance to connect to a home Wi-Fi network. Refer to Smart Functions for information on the initial setup of the **LG ThinQ** application.

### ⑦ Vegetables / Fish / Meat

This function provides storage space with a variable temperature control that can be adjusted to keep the compartment either colder or warmer than the fridge.

---

## NOTE

- The control panel automatically turns off for energy saving.
  - For optimal food preservation, increasing or decreasing 1 °C or one level from the default temperature is recommended for each compartment.
  - If there is any finger or skin contacts to the control panel while cleaning it, the button function may operate.
  - The actual temperature inside the appliance depends on the following factors: room temperature, the amount of food and how often the doors are opened, where the appliance is. Set the temperatures by considering these factors.
- 

## InstaView

This feature is only available on some models.

## Using the InstaView

The **InstaView** lets you see if you're running low on frequently used items like beverages and snacks, without opening the fridge door.

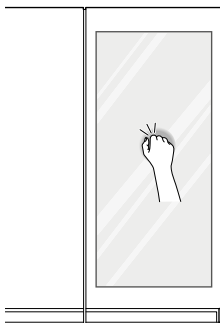

- 1 Knock twice on the glass to turn the LED light inside the **InstaView** on or off.
- 2 The LED light turns off automatically after ten seconds.

### NOTE

- The **InstaView** function is disabled for 2 seconds after closing the left or right freezer door.
- Knock near the centre of the glass. Knocking near the edges of the glass may not activate the **InstaView** function.
- Knock hard enough so that the knocking sound is audible.
- The **InstaView** function may activate if a loud noise occurs near the refrigerator.
- Clean the glass door with a dry cloth. To remove stubborn stains, slightly moisten a clean cloth with lukewarm water or a glass cleaner. Do not spray glass cleaner directly at the glass door.

## Before Using the Icemaker

### ! WARNING

- Fill with potable water only into icemaker or dispenser water tank.

### NOTE

- The icemaker produces ice normally once approximately 48 hours have passed after the appliance is initially installed.
- If half-frozen ice is put into the ice storage bin, it will cause the exiting ice cubes to lump together. It takes about 4 hours at - 20 °C for ice production.
- If the freezer door is frequently opened, warm air enters the freezer compartment. It may take a longer time to freeze ice.
- Be careful not to twist the ice maker with force since it can break.
- Do not freeze the ice in the ice storage bin. This could break it and cause appliance damage or injury.

## Using the Ice Tray

This is where ice is manually produced. You can remove the ice tray if you do not use it to create more space inside the freezer.

- 1 Fill the ice tray with potable water and place it in the freezer.



## Icemaker

This feature is only available on some models.

This feature may vary depending on model purchased.

- After the water is frozen, hold the ice tray at its ends and twist gently.



### ⚠ CAUTION

- Be careful not to twist the ice tray with force as it can be broken.
- If you open and close the freezer door frequently, it may take longer for water to be frozen.

### NOTE

- If the ice tray is overfilled, the ice cubes may stick together and be difficult to remove.
- Ice can be removed more easily by pouring water on the ice tray.

## Drawer

### ⚠ CAUTION

- Always empty the drawers before removing them, and use both hands when removing and refitting them.
- Make sure that the fridge doors are fully open before removing and refitting the drawers.

## Using the Fresh Tray

This feature is only available on some models. Use the fresh tray to store frequently-used items that require easy access.

- 1 Insert the fresh tray into the holder under the fridge shelf. Push the fresh tray completely until it stops.

- The holder may not be provided depending on model purchased.

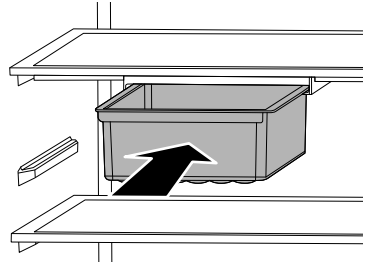

### NOTE

- You can move the fresh tray left or right to find the proper position.

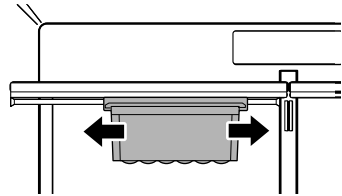

## Removing/Refitting the Fridge Drawer

- 1 Pull out the drawer to full extension, lift the front up, and pull straight out.

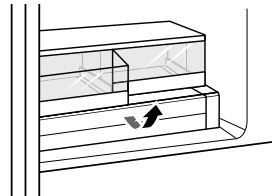

- 2 Lift the front of the cover up with both hands until it detaches from the back wall of the cabinet, then pull it out.

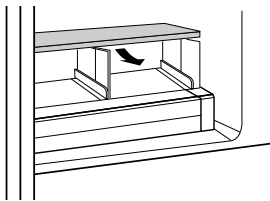

- 3 To refit, insert the cover into the refrigerator with both hands and lower it onto the guides.

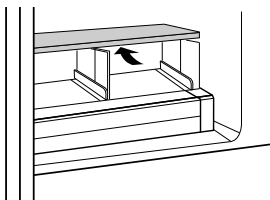

- 4 Slightly tilt up the front, insert the drawer into the frame and push it back into place.

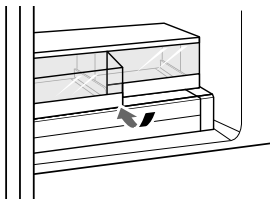

Press the **Select** button to choose between **Vegetables** (Cold), **Fish** (Colder) and **Meat** (Coldest).

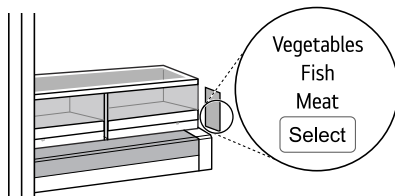

### ⚠ CAUTION

- Do not place any items on the pantry drawer cover.

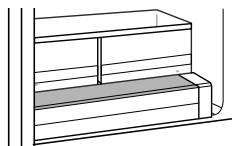

## Removing/Refitting the Pantry Drawer

- 1 To remove the pantry drawer, pull out the pantry drawer to full extension, lift the front up, and pull straight out.

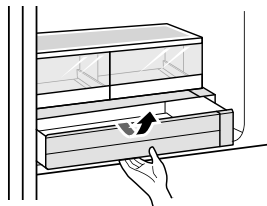

## Using the Pantry Drawer

This space is used to store vegetables, fish, meat, and other items that need to be kept chilled.

- 2** To refit, slightly tilt up the front, insert the pantry drawer into the frame and push it back into place.

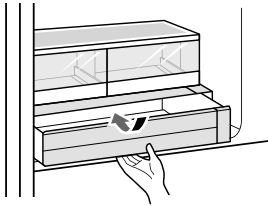

### Using the Freezer Drawer

The sliding freezer drawers allow easy access and convenience of use.

- Use the upper compartment to store packaged frozen foods and frequently-used foods.
- Use the lower compartment for larger frozen foods and items stored for longer periods.

### Removing/Refitting the Freezer Drawer

This feature may vary depending on model purchased.

- 1** Open both freezer doors completely. Pull out the freezer drawer to full extension and remove all of the contents.

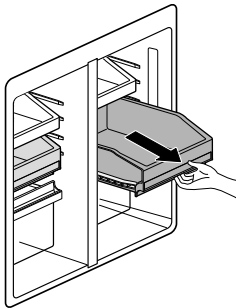

- 2** With the drawer fully extended, lift up the front and pull the drawer out to remove it.

- 3** Mount the freezer drawer in the reverse order of the removal process.

---

### ⚠ CAUTION

- The drawers are heavy. Always use two hands when removing or refitting the drawers to avoid product damage or personal injury.
  - Always open the freezer doors completely before removing or refitting the drawers.
- 

### Shelf

---

### ⚠ CAUTION

- Glass shelves are heavy. Use special care when removing them.
  - Do not clean glass shelves with warm water while they are cold. Shelves may break if exposed to sudden temperature changes or impact.
- 

### Removing/Refitting the Shelf

The shelves in the fridge are adjustable to meet individual storage needs. Adjusting the shelves to fit items of different heights will make finding the exact item you want easier.

- 1** Open the fridge doors completely.
- 2** If the Fresh Tray is inserted under the fridge shelf, remove the Fresh Tray first.
- 3** Support the shelf from the bottom and tilt one end up so the shelf is at an angle.

- If needed, lower one side of the shelf on the bottom of the refrigerator interior.

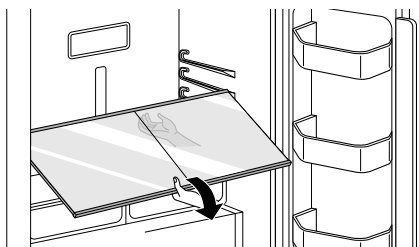

**4** Pull the shelf out.

**5** Refit the shelf in the reverse order of the removal process.

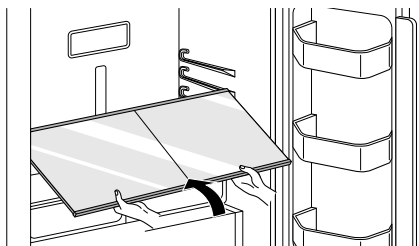

The door baskets are removable for easy cleaning and adjustment.

**1** To remove the baskets, simply lift the basket up and pull straight out.

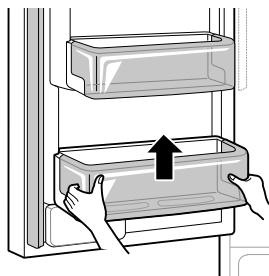

**2** To assemble the baskets, slide it in above the desired support and push down until it snaps into place.

## **⚠ CAUTION**

- Do not clean glass shelves with warm water while they are cold. Shelves may break if exposed to sudden temperature changes or impact.
- Make sure that shelves are level from one side to the other. Failure to do so may result in the shelf falling or food spilling.

## **Door Basket**

### **Removing/Refitting the Door Basket**

This feature may vary depending on model purchased.

# SMART FUNCTIONS

## LG ThinQ Application

This feature is only available on models with Wi-Fi. The **LG ThinQ** application allows you to communicate with the appliance using a smartphone.

## LG ThinQ Application Features

Communicate with the appliance from a smartphone using the convenient smart features.

### Smart Diagnosis

- If you experience a problem while using the appliance, this smart diagnosis feature will help you diagnose the problem.

### Settings

- Allows you to set various options on the appliance and in the application.

## NOTE

- In the following cases, you must update the network information for each appliance in the **LG ThinQ** application under **Device Cards > Settings > Change Network**.
  - wireless router is changed
  - wireless router password is changed
  - Internet service provider is changed
- The application is subject to change for appliance improvement purposes without notice to users.
- Functions may vary by model.

## Installing LG ThinQ Application and Connecting an LG Appliance

### Models with QR Code

Scan the QR code attached to the product using the camera or a QR code reader application on your smartphone.

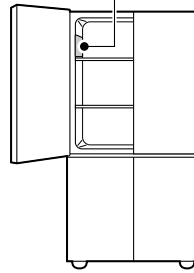

### Models without QR Code

- 1 Search for and install the **LG ThinQ** application from the Google Play Store or Apple App Store on a smartphone.
- 2 Run the **LG ThinQ** application and sign in with your existing account or create an LG account to sign in.
- 3 Touch the add (+) button on the **LG ThinQ** application to connect your LG appliance. Follow the instructions in the application to complete the process.

## NOTE

- To verify the Wi-Fi connection, check that the Wi-Fi indicator on the control panel is lit.

- The appliance supports 2.4 GHz Wi-Fi networks only. To check your network frequency, contact your Internet service provider or refer to your wireless router manual.
- **LG ThinQ** is not responsible for any network connection problems or any faults, malfunctions, or errors caused by network connection.
- The surrounding wireless environment can make the wireless network service run slowly.
- If the distance between the appliance and the wireless router is too far, the signal strength becomes weak. It may take a long time to connect or installation may fail.
- If the appliance is having trouble connecting to the Wi-Fi network, it may be too far from the router. Purchase a Wi-Fi repeater (range extender) to improve the Wi-Fi signal strength.
- The network connection may not work properly depending on the Internet service provider.
- The Wi-Fi connection may not connect or may be interrupted because of the home network environment.
- The appliance cannot be connected due to problems with the wireless signal transmission. Unplug the appliance and wait about a minute before trying again.
- If the firewall on your wireless router is enabled, disable the firewall or add an exception to it.
- The wireless network name (SSID) should be a combination of English letters and numbers. (Do not use special characters.)
- Smartphone user interface (UI) may vary depending on the mobile operating system (OS) and the manufacturer.
- If the security protocol of the router is set to **WEP**, you may fail to set up the network. Please change it to other security protocols (**WPA2** is recommended) and connect the product again.
- To disable the Wi-Fi function, press and hold the **Wi-Fi** button for 3 seconds. The Wi-Fi indicator will be turned off.
- To reconnect the appliance or add another user, press and hold the **Wi-Fi** button for 3 seconds to temporarily turn it off. Run the **LG ThinQ** application and follow the instructions in the application to connect the appliance.

## Open Source Software Notice Information

To obtain the source code that is contained in this product, under GPL, LGPL, MPL, and other open source licenses that have the obligation to disclose source code, and to access all referred license terms, copyright notices and other relevant documents, please visit <https://opensource.lge.com>.

LG Electronics will also provide open source code to you on CD-ROM for a charge covering the cost of performing such distribution (such as the cost of media, shipping, and handling) upon email request to [opensource@lge.com](mailto:opensource@lge.com).

This offer is valid to anyone in receipt of this information for a period of three years after our last shipment of this product.

## Smart Diagnosis

Use this feature to help you diagnose and solve problems with your appliance.

### NOTE

- For reasons not attributable to LGE's negligence, the service may not operate due to external factors such as, but not limited to, Wi-Fi unavailability, Wi-Fi disconnection, local app store policy, or app unavailability.
- The feature may be subject to change without prior notice and may have a different form depending on where you are located.

## Using LG ThinQ to Diagnose Issues

If you experience a problem with your Wi-Fi equipped appliance, it can transmit troubleshooting data to a smartphone using the **LG ThinQ** application.

- Launch the **LG ThinQ** application and select the **Smart Diagnosis** feature in the menu. Follow the instructions provided in the **LG ThinQ** application.

### Using Audible Diagnosis to Diagnose Issues

Follow the instructions below to use the audible diagnosis method.

- Launch the **LG ThinQ** application and select the **Smart Diagnosis** feature in the menu. Follow the instructions for audible diagnosis provided in the **LG ThinQ** application.

**1** Press the **Lock** button to activate the lock function.

- If the display has been locked for over 5 minutes, you must deactivate the lock and then reactivate it.

**2** Open the fridge door and then hold the phone on the upper right speaker hole.

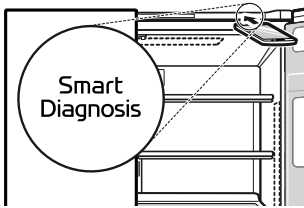

**3** Press and hold the **Freezer** button for three seconds or longer while holding your phone to the speaker until the data transfer is complete.

**4** After the data transfer is complete, the diagnosis will be displayed in the application.

---

#### NOTE

- For best results, do not move the phone while the tones are being transmitted.
-

# MAINTENANCE

## Cleaning

### General Cleaning Tips

- Performing manual defrosting, maintenance or cleaning of the appliance while food is stored in the freezer can raise the temperature of the food and reduce its storage life.
- Regularly clean any surfaces that can come in contact with food.
- When cleaning the inside or outside of the appliance, do not wipe it with a rough brush, toothpaste, or flammable materials. Do not use cleaning agents containing flammable substances. This may cause discolouration or damage to the appliance.
  - Flammable substances: alcohol (ethanol, methanol, isopropyl alcohol, isobutyl alcohol, etc.), thinner, bleach, benzene, flammable liquid, abrasive, etc.
- After cleaning, check if the power cable is damaged.

### Cleaning the Exterior

- When cleaning the outside air vents of the appliance by means of vacuuming, then the power cord should be unplugged from the outlet to avoid any static discharge that can damage the electronics or cause an electric shock. Regular cleaning of the rear and side ventilation covers is recommended to maintain reliable and economical operation of the unit.
- Keep the air vents on the exterior of the appliance clean. Blocked air vents can cause fire or appliance damage.
- For the appliance exterior, use a clean sponge or soft cloth and a mild detergent in warm water. Do not use abrasive or harsh cleaners. Dry thoroughly with a soft cloth. Do not use contaminated cloths when cleaning the stainless steel doors. Always use a dedicated cloth and wipe in the same direction as the grain. This helps reduce surface staining and tarnishing.

### Cleaning the Interior

- Before removing a shelf or drawer from inside the appliance, remove all stored foods from the shelf or drawer to prevent injury or damage to the appliance. Otherwise, injury may occur due to the weight of stored foods.
- Detach the shelves and drawers and clean them with water and a mild detergent, and then dry them sufficiently, before replacing them.
- Regularly wipe the door gaskets and door seals with water and a mild detergent. Never use solvent or acidic based chemicals to clean the interior. Doing so will alter its integrity.
- Door basket spills and stains should be cleaned as they can compromise storage ability of the basket and could even be damaged.
- Never clean the shelves, door baskets, or containers in the dishwasher or in hot water. The parts may become deformed, and glass may shatter due to the heat.
- The automatic defrosting system in the appliance ensures that the compartment remains free of ice buildup under normal operating conditions. Users do not need to defrost it manually.

### Cleaning the Condenser Cover

Use a vacuum cleaner with a brush to clean the condenser cover and vents. Do not remove the panel covering the condenser coil area. We strongly recommend that this be done every 12 months to maintain operating efficiency. Failing to do so could cause loss of cooling, higher energy usage and compressor overheating.

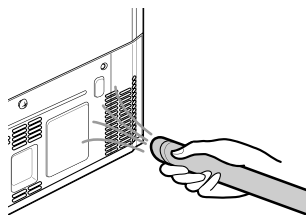

# TROUBLESHOOTING

## Before Calling for Service

### Cooling

Symptoms	Possible Cause & Solution
There is no refrigeration or freezing.	<b>Is there a power interruption?</b> <ul style="list-style-type: none"> <li>Check the power of other appliances.</li> </ul>
	<b>Appliance is unplugged.</b> <ul style="list-style-type: none"> <li>Plug the power plug in the outlet properly.</li> </ul>
	<b>A fuse in your home may be blown or the circuit breaker tripped. Or the appliance is connected to a GFCI (Ground Fault Circuit Interrupter) outlet, and the outlet's circuit breaker has tripped.</b> <ul style="list-style-type: none"> <li>Check the main electrical box and replace the fuse or reset the circuit breaker. Do not increase fuse capacity. If the problem is a circuit overload, have it corrected by a qualified electrician.</li> <li>Reset the circuit breaker on the GFCI. If the problem persists, contact an electrician.</li> </ul>
There is poor refrigeration or freezing.	<b>Is the fridge or freezer temperature set to its warmest setting?</b> <ul style="list-style-type: none"> <li>Set the fridge or freezer temperature to a colder setting.</li> </ul>
	<b>Is the appliance in direct sunlight, or is it near a heat generating object such as cooking oven or heater?</b> <ul style="list-style-type: none"> <li>Check the installation area and reinstall it away from heat generating objects.</li> </ul>
	<b>Did you store hot food without cooling it first?</b> <ul style="list-style-type: none"> <li>Cool the hot food first before putting it in the fridge or freezer compartment.</li> </ul>
	<b>Did you put in too much food?</b> <ul style="list-style-type: none"> <li>Maintain an appropriate space between food.</li> </ul>
	<b>Are the appliance doors completely closed?</b> <ul style="list-style-type: none"> <li>Completely close the door and make sure that stored food is not obstructing in the door.</li> </ul>
	<b>Is there enough space around the appliance?</b> <ul style="list-style-type: none"> <li>Adjust the installation position to make enough space around the appliance.</li> </ul>
The appliance contains a bad smell.	<b>Is the fridge or freezer temperature set to its warmest setting?</b> <ul style="list-style-type: none"> <li>Set the fridge or freezer temperature to a colder setting.</li> </ul>

Symptoms	Possible Cause & Solution
The appliance contains a bad smell.	<b>Did you put in food with a strong smell?</b> <ul style="list-style-type: none"> <li>Store foods with strong smells in sealed containers.</li> </ul>
	<b>Vegetables or fruit may have spoiled in the drawer.</b> <ul style="list-style-type: none"> <li>Throw away rotten vegetables and clean the vegetable drawer. Do not store vegetables too long in the vegetable drawer.</li> </ul>

## Condensation & Frost

Symptoms	Possible Cause & Solution
There is condensation inside the appliance or on the bottom of the vegetable drawer cover.	<b>Did you store hot food without cooling it first?</b> <ul style="list-style-type: none"> <li>Cool the hot food first before putting it inside the fridge or freezer.</li> </ul>
	<b>Did you leave the appliance door open?</b> <ul style="list-style-type: none"> <li>Although the condensation will disappear soon after you close the appliance door, you can wipe it with a dry cloth.</li> </ul>
	<b>Do you open and close the appliance door too frequently?</b> <ul style="list-style-type: none"> <li>Condensation can form due to the temperature difference from the outside. Wipe out the dampness with a dry cloth.</li> </ul>
	<b>Did you put warm or moist food inside without sealing it in a container?</b> <ul style="list-style-type: none"> <li>Store food in a covered or sealed container.</li> </ul>
Frost has formed in the freezer compartment.	<b>Doors may not be closed properly.</b> <ul style="list-style-type: none"> <li>Check if the food item inside the appliance is blocking the door and make sure that the door is tightly closed.</li> </ul>
	<b>Did you store hot food without cooling it first?</b> <ul style="list-style-type: none"> <li>Cool the hot food first before putting it in the fridge or freezer compartment.</li> </ul>
	<b>Is the air entry or exit of the freezer compartment blocked?</b> <ul style="list-style-type: none"> <li>Make sure that air entry or exit is not blocked so that the air can circulate inside.</li> </ul>
	<b>Is the freezer compartment overfilled?</b> <ul style="list-style-type: none"> <li>Maintain an appropriate space between items.</li> </ul>
Frost or condensation has formed inside or outside the appliance.	<b>Did you open and close the appliance door frequently or is the appliance door improperly closed?</b> <ul style="list-style-type: none"> <li>Frosts or condensation can form if the outside air penetrates inside the appliance.</li> </ul>

Symptoms	Possible Cause & Solution
<b>Frost or condensation has formed inside or outside the appliance.</b>	<p><b>Is the installation environment humid?</b></p> <ul style="list-style-type: none"> <li>Condensation can appear on the exterior of the appliance if the installation area is too humid or on a humid day such as a rainy day. Wipe off any moisture with a dry cloth.</li> </ul>
<b>The side or front of the appliance is warm.</b>	<p><b>There are anti condensation pipes fitted to these areas of the appliance to reduce condensation forming from around the door area.</b></p> <ul style="list-style-type: none"> <li>The heat releasing pipe to prevent condensation is installed on the front and side of the appliance. You may feel it particularly hot right after the appliance is installed or during the summer. You can be assured that this is not a problem and is quite normal.</li> </ul>
<b>There is water inside or outside of the appliance.</b>	<p><b>Is there water leakage around the appliance?</b></p> <ul style="list-style-type: none"> <li>Check if the water has leaked from a sink or another place.</li> </ul>
	<p><b>Is there water on the bottom of the appliance?</b></p> <ul style="list-style-type: none"> <li>Check if the water is from the thawed frozen food or a broken or dropped container.</li> </ul>

## Parts & Features

Symptoms	Possible Cause & Solution
<b>The appliance door is not closed tightly.</b>	<p><b>Is the appliance leaning forward?</b></p> <ul style="list-style-type: none"> <li>Adjust the front feet to raise the front side slightly.</li> </ul>
	<p><b>Were the shelves properly assembled?</b></p> <ul style="list-style-type: none"> <li>Refit the shelves if needed.</li> </ul>
	<p><b>Did you close the door with excessive force?</b></p> <ul style="list-style-type: none"> <li>If you apply too much force or speed when closing the door, it may remain briefly open before closing. Make sure that you do not slam the door closed. Close the door gently.</li> </ul>
<b>It is difficult to open the appliance door.</b>	<p><b>Did you open the door right after you closed it?</b></p> <ul style="list-style-type: none"> <li>If you try to open the appliance door within one minute after you closed it, you may have difficulties because of the pressure inside the appliance. Try to open the appliance door again in a few minutes so that the internal pressure stabilizes.</li> </ul>
<b>Door mullion does not fold in and out properly.</b>	<p><b>Are front levelling legs extended, the appliance level, and doors aligned?</b></p> <ul style="list-style-type: none"> <li>Once the door baskets are filled, the doors may become misaligned, preventing the door mullion or the Auto Open Door function from working properly. Extend both front levelling legs fully so they are in firm contact with the floor. Follow the instruction in the Door Alignment section to raise the left fridge door until the door mullion is once again working properly. Adjust the right fridge door so it aligns with the left fridge door.</li> </ul>

Symptoms	Possible Cause & Solution
<b>The inside lamp in the appliance does not turn on.</b>	<p><b>Lamp failure</b></p> <ul style="list-style-type: none"> <li>• Close the door and re-open. If the lamp does not turn on, please contact the LG Electronics customer information centre. Do not attempt removal of the lamp.</li> </ul>

## Noises

Symptoms	Possible Cause & Solution
<b>The appliance is noisy and generates abnormal sounds.</b>	<p><b>Is the appliance installed on a weak floor or improperly levelled?</b></p> <ul style="list-style-type: none"> <li>• Install the appliance on a solid and flat area.</li> </ul>
	<p><b>Does the rear of the appliance touch the wall?</b></p> <ul style="list-style-type: none"> <li>• Adjust the installation position to allow enough clearance around the appliance.</li> </ul>
	<p><b>Are objects scattered behind the appliance?</b></p> <ul style="list-style-type: none"> <li>• Remove the scattered objects from behind the appliance.</li> </ul>
	<p><b>Is there an object on top of the appliance?</b></p> <ul style="list-style-type: none"> <li>• Remove the object on top of the appliance.</li> </ul>
<b>Clicking noises</b>	<p><b>The defrost control will click when the automatic defrost cycle begins and ends. The thermostat control (or appliance control on some models) will also click when cycling on and off.</b></p> <ul style="list-style-type: none"> <li>• Normal Operation</li> </ul>
<b>Rattling noises</b>	<p><b>Rattling noises may come from the flow of appliance, the water line on the back of the unit (for plumbed models only), or items stored around the appliance.</b></p> <ul style="list-style-type: none"> <li>• Normal Operation</li> </ul>
	<p><b>Appliance is not resting evenly on the floor.</b></p> <ul style="list-style-type: none"> <li>• Floor is weak or uneven or levelling legs need to be adjusted. See the Door Alignment section.</li> </ul>
	<p><b>Appliance with a compressor was moved while operating.</b></p> <ul style="list-style-type: none"> <li>• Normal operation. If the compressor does not stop rattling after three minutes, turn the power to the appliance off and then on again.</li> </ul>
<b>Whooshing noises</b>	<p><b>Evaporator fan motor is circulating air through the fridge and freezer compartments.</b></p> <ul style="list-style-type: none"> <li>• Normal Operation</li> </ul>
	<p><b>Air is being forced over the condenser by the condenser fan.</b></p> <ul style="list-style-type: none"> <li>• Normal Operation</li> </ul>

Symptoms	Possible Cause & Solution
Gurgling noises	<b>Appliance flowing through the cooling system.</b> <ul style="list-style-type: none"> <li>• Normal Operation</li> </ul>
Popping noises	<b>Contraction and expansion of the inside walls due to changes in temperature.</b> <ul style="list-style-type: none"> <li>• Normal Operation</li> </ul>
Vibrating	<b>If the side or back of the appliance is touching a cabinet or wall, some of the normal vibrations may make an audible sound.</b> <ul style="list-style-type: none"> <li>• To eliminate the noise, make sure that the sides and back do not make any contact with any wall or cabinet.</li> </ul>
Buzzing sound from the water tank. (Non plumbed models only)	<b>You may hear valve a buzzing sound from the water tank if the icemaker is on and the water tank is empty.</b> <ul style="list-style-type: none"> <li>• Fill the water tank or turn the icemaker off.</li> </ul>

## Wi-Fi

Symptoms	Possible Cause & Solution
Your home appliance and smartphone are not connected to the Wi-Fi network.	<b>The password for the Wi-Fi that you are trying to connect to is incorrect.</b> <ul style="list-style-type: none"> <li>• Find the Wi-Fi network connected to your smartphone and remove it, then register your appliance on <b>LG ThinQ</b>.</li> </ul>
	<b>Mobile data for your smartphone is turned on.</b> <ul style="list-style-type: none"> <li>• Turn off the <b>Mobile data</b> of your smartphone and register the appliance using the Wi-Fi network.</li> </ul>
	<b>The wireless network name (SSID) is set incorrectly.</b> <ul style="list-style-type: none"> <li>• The wireless network name (SSID) should be a combination of English letters and numbers. (Do not use special characters.)</li> </ul>
	<b>The router frequency is not 2.4 GHz.</b> <ul style="list-style-type: none"> <li>• Only a 2.4 GHz router frequency is supported. Set the wireless router to 2.4 GHz and connect the appliance to the wireless router. To check the router frequency, check with your Internet service provider or the router manufacturer.</li> </ul>
	<b>The distance between the appliance and the router is too far.</b> <ul style="list-style-type: none"> <li>• If the distance between the appliance and the router is too far, the signal may be weak and the connection may not be configured correctly. Move the location of the router so that it is closer to the appliance.</li> </ul>

# APPENDIX

## Information

### Product Information

Model	GV-B25FFGMB GV-B25FFLMB	GV-B23FFGMB GV-B23FFLMB
Operating Principle	Vapour Compressor Refrigerator System	
Pull-Down Time (min)	308	308
Cooling Time (hours)	7.5	7.5
Rated Energy Consumption (kWh/Yr.)	530	510
Rated Total Volume (L)	610	574
Rated Total Fresh Food Volume (L)	437	401
Rated Total Freezer Volume (L)	173	173
Star Rating (Freezer)	4 star	4 star
Temperature Rise Time (hours)	8.83	8.83
Specific Freezing Capacity (kg/12h)	5	5

## Warranty

### Warranty and Service Information

The LG Refrigerator (hereinafter referred as product) comes with 1 year warranty on all Parts (except Consumables, Bulb, Loose Plastic Parts, Glass) in the first year from the date of purchase on producing the tax paid invoice provided always that the warranty card bears the rubber stamp, date and signature of our Authorized Dealer showing the Additional warranty on compressor as specified below shall be on fulfilling the above mentioned conditions.

#### 9 (SELECTED MODEL) YEAR ADDITIONAL WARRANTY ON COMPRESSOR

The 9 Year warranty (Selected Model) on Compressor will continue even after expiry of 1 year period from the date of purchase. This warranty covers Compressor only. Gas charging related gas and applicable service charges will be charged to the customer. During the additional warranty period, it does not cover any part such as PCB assembly, condenser, freezer, capillary, suction line, overload protector, relay, thermostat etc., standard service charges will be applicable within the municipal limit of town where LG Electronics India Ltd. (LGEIL) has its Authorized Service center, service outside municipal limit will attract to and fro traveling, other incidental expenses in addition to standard service charges, as prevailing from time to time.

#### TERMS & CONDITIONS

- 1) The warranty is confined to the first purchaser of the Refrigerator only & is non-transferable.

- 2) Repairs & replacements will be carried out by the dealer from whom the product has been purchased, or through the Authorized Service Centers of LG Electronics. In case the customer shifts the place of residence during warranty period, it is advised to contact Authorized Service Centre directly or call our help line.
- 3) Repairs under warranty shall be carried out by an authorized service personnel only. The details of centralized help lines are attached.
- 4) For units installed beyond municipal limits of the jurisdiction of company's Authorized Service Center, it is responsibility of the purchaser to contact the nearest authorized service center and bring the unit to the authorized service center at its own cost and risk. All expenses incurred in collecting the units or parts thereof from the company's authorized service center, as well as expenses incurred with deputed service personnel/technicians towards conveyance and other incidentals etc. will be borne by the customer. Local charges for transportation and handling charges may vary from location to location. Customers are advised to verify before. In case the customer desires to bring the unit on its own to the Authorized Service Centre, the same shall be at its own risks & consequences.
- 5) The concerned authorized service center will advise the customer whether to effect the repairs at site or at the authorized service center.
- 6) Call registered with the centralized helpline/Authorized service center, wherein only cleaning of the unit/parts in the unit due to dust accumulation on portions of the unit, general explanations/returning, are not to be considered as defects.
- 7) In case of repairs or replacement of any part/s of the unit, this warranty will thereafter continue and remain in force only for the unexpired period of the warranty. Replacement of parts would be purely at the discretion of LGEIL alone. In case the replacement of the entire unit is being made, (subject to the sole discretion of LGEIL), the same model shall be replaced and in the event such model has been discontinued, it shall be replaced with the model of price equivalent at the time of purchase.
- 8) In case of any damage to the product / customer abuse/ repairs by un-authorized personnel/ misuse detected/ by the Authorized Service Center personnel, the warranty conditions are not applicable and repairs will be done subject to availability of parts and on a chargeable basis only.
- 9) This warranty shall not cover any consequential or resulting liability, damage or loss to property or life arising directly or indirectly out of any defect in the Refrigerator. The company's obligation under this warranty shall be limited to repair or providing replacement of defective parts only under the warranty period.
- 10) The company or its Authorized Service Center reserves the right to retain any part/s or component replaced at its discretion, in the event of a defect being noticed in the equipment during warranty period.
- 11) While the company will make every effort to carry out repairs at the earliest, it however is made expressly clear that the company is under no obligation to do so in a specified period of time.
- 12) In the event of any unforeseen circumstance, and spares not being available, the company's prevailing depreciation rules may apply on the purchaser to accept as a commercial solution in lieu of repairs.
- 13) Warranty does not cover accessories external to the equipment supplied by the dealer.
- 14) If any coloured internal or external components are replaced, there will be commitment to ensure that the shades match with the original or other components. The replaced shades, patterns, tints may vary from the customer's unit due to continuous usage of the unit. Any matching components changed at customer's request will be on chargeable basis except the component which actually needed.
- 15) Free Installation or Demo of the product, can be availed only once & within 3 months from the date of purchase.
- 16) Any extended warranty offered by LGEIL has to be supported by relevant proof.

- 17) This warranty will automatically terminate on the expiry of the warranty period of 12 months, even if the Refrigerator may not be in use for any time during the warranty period for any reason. The warranty on compressor will automatically terminate on expiry of 9\*(Selected Model) years (after 1 year warranty period) even if the Refrigerator may not be in use for any time during the said period for any reason.
- 18) Only courts in state of Delhi and places where LGEIL has its branch office shall have the jurisdiction for settling any claims, disputes arising under the warranty.

**Warranty is not applicable in any of the following cases :**

- 1) The warranty card is not completed properly at the time of purchase.
- 2) The completed warranty card is not presented to authorized service personnel at the time of service of the product.
- 3) The product is not operated according to instructions given in the Operating Instruction Booklet.
- 4) The product is used for commercial purposes.
- 5) The product has failed under certain conditions like water logging, flood, fire, misuse etc.
- 6) Defects are caused by improper or reckless use, which shall be determined by the company personnel.
- 7) Any repair work is carried out by persons other than authorized service personnel.
- 8) Defects are caused by due to causes beyond control like lightening, abnormal voltage, acts of God or while in transit to service center or purchaser's residence.
- 9) Any issue is caused by usage of 3rd party product like voltage stabilizer, power outlet socket, MCB, extension board etc.
- 10) Defects/malfunction caused while in transit to service centre or purchaser's residence.
- 11) Defects caused by rodents bite or by pests and vermin ants/Insects/animals/birds etc.
- 12) The warranty is not valid in case, the serial number is deleted, defected or altered.
- 13) Damage to the product or any part/s due to transportation or shifting is not covered by warranty.
- 14) Use of knife or sharp instrument is used to remove the ice trays or Ice from the freezer or to remove the frost mechanically and as a result Compressor, Evaporator, Condensers, capillary, suction line & other related items get spoiled.
- 15) Any accessory external to the equipment are supplied by dealer or LG.
- 16) Any issue of Wi-Fi connectivity or compatibility with other products or software's is there.
- 17) Any loss of data.

**CUSTOMER'S COPY**

-----  
CUSTOMER'S COPY

MODEL No. :

DATE OF PURCHASE :

UNIT SERIAL No. :

CUSTOMER'S NAME & ADDRESS _____ _____ TEL. _____
---

DEALER'S NAME & ADDRESS _____ _____ TEL. _____
---

Customer's Signature

Dealer's Signature

This card is valid only if it is filled in and stamped by our authorised dealer on the date of purchase.

**Memo**

**Memo**



### Importer (LG Electronics India Ltd.) & Packaging Type Details as per PWM Rules

Packaging type	Company name	Registration number	Thickness
Plastic Sheet	LG Electronics India Ltd	IM-13-000-07-AAACL1745Q-22	0.05 mm and above
Multilayered bag	LG Electronics India Ltd		N/A

### LG Electronics India Ltd.

Phone	08069379999 1800 315 9999 [Toll Free]
WhatsApp No.	9711709999
Mobile Application	'LG Service India Mobile App' available at Google Play
SNS	<a href="http://www.facebook.com/LGIndiaPage">www.facebook.com/LGIndiaPage</a> <a href="http://www.twitter.com/LGIndia">www.twitter.com/LGIndia</a>
Address	Regd. Office: LG Electronics India Ltd., A-24/6 Mohan Cooperative Industrial Estate, Mathura Road, New Delhi-110044 CIN No. U32107DL1997PLC220109

24 hours, 7 days a week ( except National Holidays )