



OWNER'S MANUAL

Wi-Fi

Soundbar

Please read this manual carefully before operating your set and retain it for future reference.

Model

S80TR (S80TR, SPT8-W, SPT85-SL, SPT85-SR)

Soundbar Quick Guide

Installing and using the Product

1 Connect the soundbar to your TV via an optical cable or an HDMI cable.

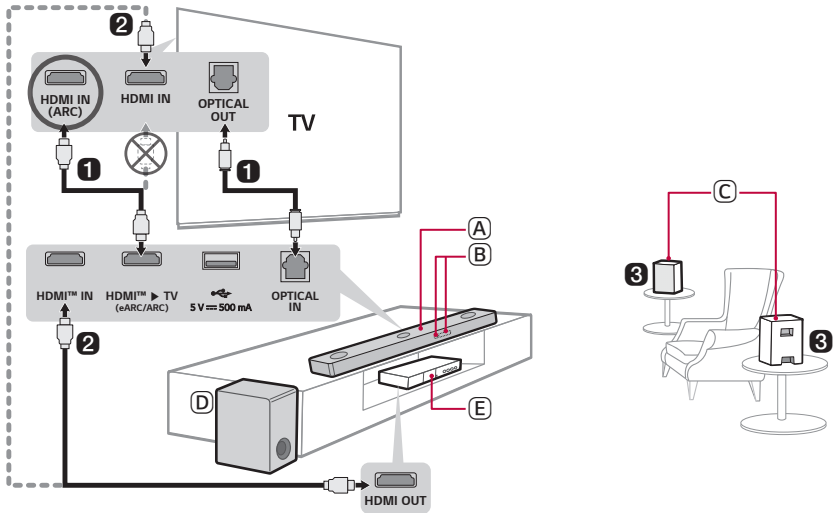

- (A) Soundbar
- (B) Remote Control Receiver / Status Display
- (C) Wireless Rear Speakers
- (D) Wireless Subwoofer - Install it close to the soundbar.
- (E) External Device - (Blu-ray player, game console, etc.)

- ② If you are using an external device (ex. Set-top box, Blu-ray player, game console, etc.), connect it to the soundbar or to the TV via an HDMI cable.
- ③ Connect to power in the following order: wireless subwoofer → wireless rear speakers → soundbar. Then, turn on the soundbar. When the connection is automatically established with the soundbar, the LEDs on the wireless subwoofer and wireless rear speakers will light up green. (→ See “Connecting the Product” on page 6.)





④ Using the product with your TV (→ See “Connecting with an Optical Cable”, “Connecting with an HDMI Cable”, “Connecting via Bluetooth” on page 30, 32, 34.)

- ① Press the **Function**  button repeatedly until “**OPT/HDMI ARC**” appears on the status display.
- ② On your TV’s settings, set the output speaker to [HDMI ARC], [Optical], [LG WOWCAST], or [External Speaker].
- ③ When the TV is properly connected to the product, “**OPT**”, “**ARC**”, or “**E-ARC**” will appear on the status display with a sound.

⑤ Connecting the product to your smartphone via Wi-Fi (→ See “Connecting with the product via LG ThinQ app” on page 16.)

- ① Connect your smartphone to Wi-Fi.
- ② Install the **LG ThinQ app** on Google Play or the App Store.
- ③ Run the **LG ThinQ app** and follow the instructions.
- ④ The product will connect to your smartphone and you can control the product with **LG ThinQ app**.

6 Connecting the product to your smartphone via Bluetooth (→ See “Connecting via Bluetooth” on page 39.)

- 1 Tap the **Settings**  button on your smartphone and select **Bluetooth**. Turn on the **Bluetooth** function. ( **Off** >  **On**)
- 2 Press the **Bluetooth pair**  button. After a moment, you will see “**BT READY**” on the status display.
- 3 Find and select “**LG_Speaker_S80TR_XXXX**”.
- 4 When the product is connected to your smartphone via **Bluetooth**, you can see the status display change from “**PAIRED**” → “**Connected Bluetooth device name**” → “**BT**”.

Manually connecting the soundbar to the wireless subwoofer or wireless rear speakers (→ See “Connecting the wireless subwoofer and wireless rear speakers manually” on page 8.)

If you see a red LED on the wireless subwoofer or wireless rear speakers, it means that the soundbar is not connected to the speakers. If this is the case, connect them in the following order.



- 1 Press the **Power**  button on the soundbar to turn it off.
- 2 Press the **PAIRING** button on the back of the wireless subwoofer or wireless rear speakers. Check if each LED blinks green.
 - If you still see a red LED on the wireless subwoofer or wireless rear speakers, press and hold the button on the back of the subwoofer or wireless rear speakers again.
- 3 Press the **Power**  button on the soundbar to turn it on.
- 4 When the connection is established, you will see a green LED light on the wireless subwoofer or wireless rear speakers light up green.

Table of Contents

Soundbar Quick Guide

- 2 Installing and using the Product

Installation

- 6 Connecting the Product
- 10 Setting up surround sound
- 16 Connecting with the product via LG ThinQ app
- 17 Installing the LG ThinQ app and registering the product
- 19 Resetting the Product

Exploring the Product

- 20 Front
- 22 Back
- 23 Exploring Remote Control

Various settings for convenience

- 27 Convenient functions

Connecting to the TV

- 30 Connecting with an Optical Cable
- 32 Connecting with an HDMI Cable
- 34 Connecting via Bluetooth

Connecting to an External Device

- 35 Connecting with an HDMI Cable
- 38 Connecting with an Optical Cable

Using the Product as an Audio System

- 39 Connecting via Bluetooth
- 42 Connecting to a USB Storage Device
- 44 Using the LG ThinQ app
- 45 Compatible with Google Assistant

- 46 Works with Apple AirPlay
- 47 Spotify Connect
- 48 Works with Alexa

Mounting the Product to a Wall

- 49 Checking before mounting to a wall
- 51 Mounting the Product to a Wall

Safety Precautions

- 53 Safety and Regulatory
- 56 Prevention of product misuse

Before Reporting Product Malfunction

- 60 Troubleshooting

Appendix

- 66 Specifications
- 68 Registered Trademarks and Licenses
- 70 What You Need to Know about Network Services
- 70 Open Source Software Notice Information
- 71 Handling the Product

Installation

Connecting the Product

You can enjoy a richer sound by connecting the soundbar to the wireless subwoofer.

Connecting the wireless subwoofer automatically

After completing installation, the wireless subwoofer will automatically be connected to the soundbar. Connect the soundbar to the subwoofer in the following order.

- 1 Plug the power cable into the wireless subwoofer.
- 2 Plug the power cable connected to the wireless subwoofer into an outlet.
- 3 Plug the power cables into the wireless rear speakers and arrange the power cables.
- 4 Plug the power cables connected to the wireless rear speakers into outlets.

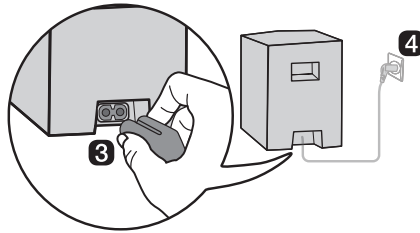
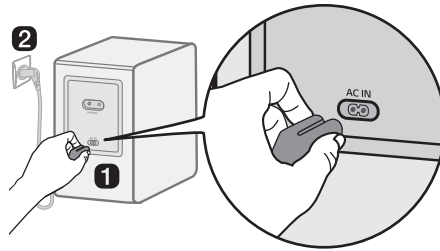

- 5 Plug the power cable into the soundbar.
- 6 Plug the power cable connected to the soundbar into an outlet.
- 7 Press the **Power**  button on the soundbar to turn it on.

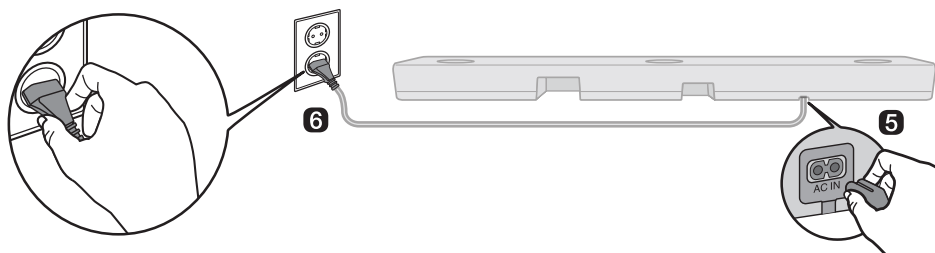

- 8 When the connection is automatically established, you will see the LEDs on the back of the wireless subwoofer and wireless rear speakers light up green.

Checking the connection with the LEDs on the back of the wireless subwoofer and wireless rear speakers

You can check the connection status by looking at the LEDs on the back of the wireless subwoofer and wireless rear speakers.

LED Colour	Status
Blinking green	Connecting in progress
Green	Connected successfully
Red	Bad connection, or the subwoofer or wireless rear speakers are in standby
Off	Power cable not connected

Connecting the wireless subwoofer and wireless rear speakers manually

If you see a red LED on the back of the wireless subwoofer or wireless rear speakers, it means that the soundbar is not connected to the subwoofer or wireless rear speakers. If this is the case, connect them in the following order.

- 1 Press the **Power**  button on the soundbar to turn it off.
- 2 Press the **PAIRING** button on the back of the wireless subwoofer or wireless rear speakers. Check if the LED on the back of the subwoofer or wireless rear speakers is blinking green. If you still see a red LED on the wireless subwoofer or wireless rear speakers, press and hold the button on the back of the subwoofer or wireless rear speakers again.

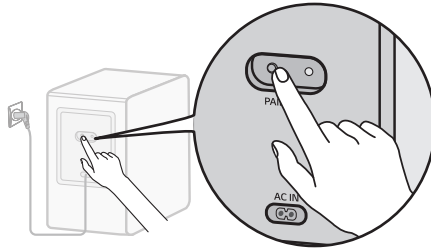

Connecting the wireless subwoofer manually

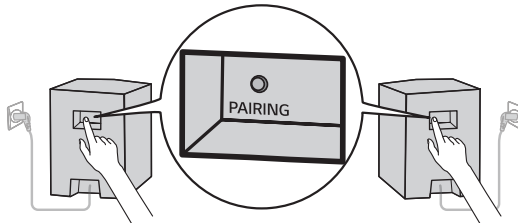

Connecting the wireless rear speakers manually

- 3 Press the **Power**  button on the soundbar to turn it on.
- 4 When the connection is established, you will see the LED light on the back of the wireless subwoofer or wireless rear speakers light up green.

✔ **Note**

- Install the soundbar as close to the wireless subwoofer as possible. The closer the distance between the soundbar and the wireless subwoofer, the better the sound quality.
- Please ensure there are no obstacles between the soundbar and the wireless subwoofer.
- Keep the rear speakers at least 30 cm away from the TV or monitor.
- To prevent wireless interference, maintain a distance of at least 1 m between the soundbar or the wireless subwoofer, wireless rear speakers and any peripheral devices that generate strong electromagnetic waves (ex. wireless routers, microwave ovens, etc.).

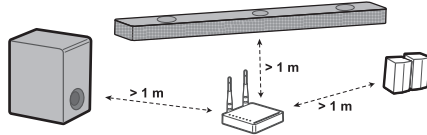

Setting up surround sound

The surround sound function allows you to hear immersive 3D sound produced by multiple audio channels from the speakers, regardless of the channels in the originally recorded content.

For example, if you listen to music recorded in 2.0 channels with standard sound effects while the wireless rear speakers are connected, you can hear the following difference.

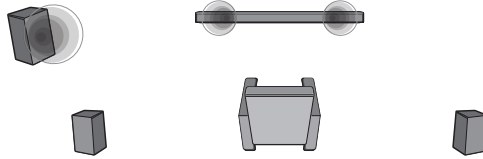

When the surround sound is off

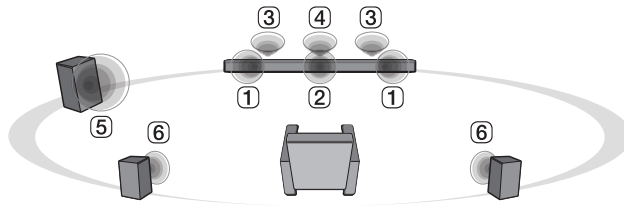

When the surround sound is on

✔ Note

• Speaker positions are as follows.

- ① Front speakers
 - ② Centre speaker
 - ③ Top speakers
 - ④ Top centre speaker
 - ⑤ Subwoofer
 - ⑥ Rear speakers
-

Turning surround sound on/off

- 1 Press **Settings**  button. The product enters the setting mode and you can see "**OFF-AUTO POWER**" or "**ON-AUTO POWER**".

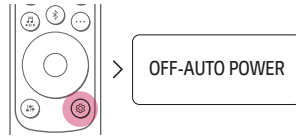



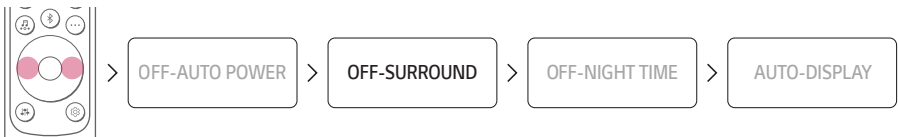

- 2 While the "**OFF-AUTO POWER**" or "**ON-AUTO POWER**" is scrolling in the status display, press **Left/Right** button to select the surround sound setting. You can see the status of the surround sound, "**OFF-SURROUND**" or "**ON-SURROUND**".

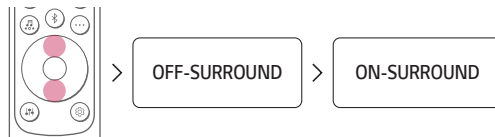

- 3 While the "**OFF-SURROUND**" or "**ON-SURROUND**" is scrolling in the status display, press **Up/Down** button to turn on or off the surround sound.

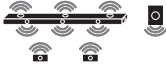

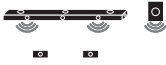
Speaker sound based on input channels

Sound Effects		
Input	Output	
	Rear speakers not connected	Rear speakers connected
AI SOUND PRO Sound customised with artificial intelligence		
2.0 channels		
5.1 channels		
7.1 channels or more		
7.1.4 channels		
STANDARD You can enjoy optimised sound		
2.0 channels		
5.1 channels		
7.1 channels or more		
7.1.4 channels		

Sound Effects		
Input	Output	
	Rear speakers not connected	Rear speakers connected

CINEMA

Cinematic 3D sound

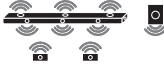
Input	Rear speakers not connected	Rear speakers connected
2.0 channels		
5.1 channels		
7.1 channels or more		
7.1.4 channels		

CLEAR VOICE PRO

Improves the clarity of voices

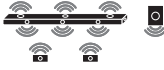



Input	Rear speakers not connected	Rear speakers connected
2.0 channels		
5.1 channels		
7.1 channels or more		
7.1.4 channels		

Sound Effects

Input	Output	
	Rear speakers not connected	Rear speakers connected





SPORTS

Realistic sound like in a stadium

2.0 channels		
5.1 channels		
7.1 channels or more		
7.1.4 channels		

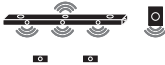
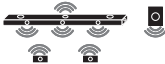
MUSIC

You can enjoy better sound optimised for music

2.0 channels		
5.1 channels		
7.1 channels or more		
7.1.4 channels		

Sound Effects		
Input	Output	
	Rear speakers not connected	Rear speakers connected

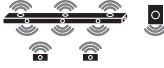

GAME

Optimised sound for playing games

Input	Rear speakers not connected	Rear speakers connected
2.0 channels		
5.1 channels		
7.1 channels or more		
7.1.4 channels		

BASS BLAST (BASS BLAST+)

Sound with reinforced bass

Input	Rear speakers not connected	Rear speakers connected
2.0 channels		
5.1 channels		
7.1 channels or more		
7.1.4 channels		

Connecting with the product via LG ThinQ app

LG ThinQ app allows you to connect the product to the network and to control the product.

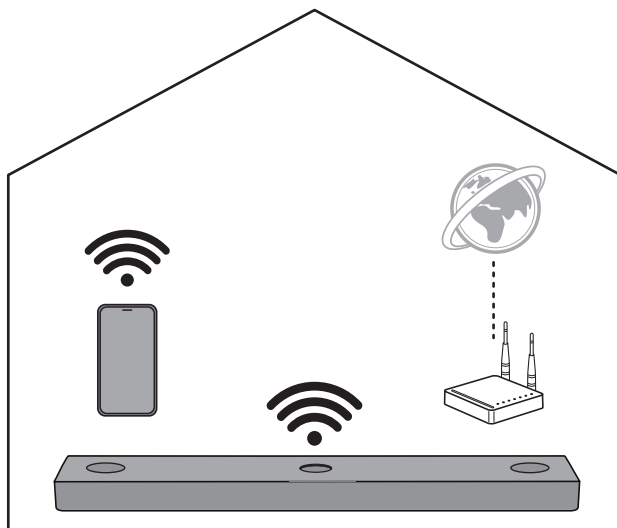

Please check the following first.

- Do you have a wireless router?
 - To connect your smartphone and the product via Wi-Fi, you must have a wireless router that is connected to the internet.
 - Make sure that they are both connected to the same Wi-Fi network.
 - If the wireless router signal is weak, it may not be able to connect. Move the router closer to the soundbar or reposition it away from obstacles.
- Does your smartphone have **Bluetooth** enabled?
 - Enable **Bluetooth** on your smartphone.
 - If **Bluetooth** is enabled, you can easily connect to Wi-Fi. If **Bluetooth** is disabled, the product may not be registered on the **LG ThinQ app**.
- The **LG ThinQ app** is available in the versions listed below.
 - Android™ OS: Version 9.0 or higher
 - iOS OS: Version 15.0 or higher
 - Minimum supported versions for each OS may change later.

Installing the LG ThinQ app and registering the product

You can manage your home appliance whenever wherever by the **LG ThinQ app**.

Product without the QR code

- 1 Go to the Google Play or the App Store on your smartphone and search for the **LG ThinQ app** to install it.
- 2 Run the **LG ThinQ app** and log in to the app with your account. If you don't have an account, you can also create a new one.
- 3 Press the **add (+)** button and follow the instructions on the **LG ThinQ app** to register your product.

Product with the QR code

Scan the QR code on the bottom of the product with your smartphone camera or a QR code scan app.

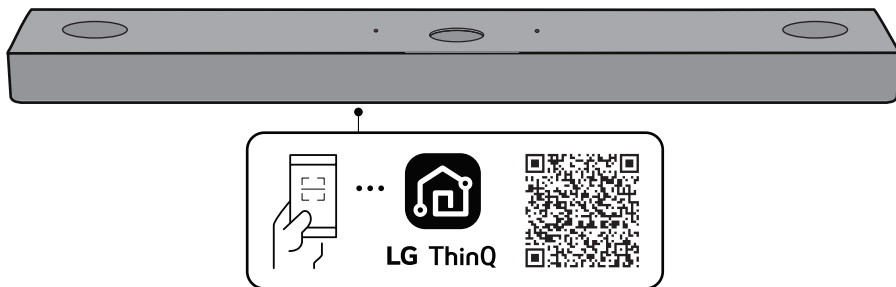

✔ **Note**

- Please note that the QR code may not be available at the time of purchase.
 - The QR code attachment location may differ depending on the product.
 - Settings menu items may vary depending on the smartphone manufacturer and OS.
 - Google, Android, Google Play, Google Home and Google Cast are trademarks of Google LLC.
 - If the router password contains some special characters (such as ` ' " + / \ ; : - _ ^ & () < >) or emoticons, the soundbar may not be connected. It is recommended to set a password using a combination of English letters and numbers.
 - It is recommended to set the security type of the wireless router to WPA2.
-

Resetting the Product

If the network connection is unstable, you will need to reset it. If the Wi-Fi network has been changed, you will need to reset the product and connect it to your smartphone again.

How to reset

- 1 Press and hold the **Wi-Fi**  button on the side of the product until you hear a sound signal.
- 2 You will see “**RESET**” appear on the status display, and all wireless network settings on the product will be cleared.

✔ Note

- Once you reset the product, you will also need to reconnect the product to the smartphone via Wi-Fi on the **LG ThinQ app**.
-

How to deactivate the wireless network connection(s).

Press and hold the **Power**  button for 3 seconds or longer to turn off the product.

Exploring the Product

Front

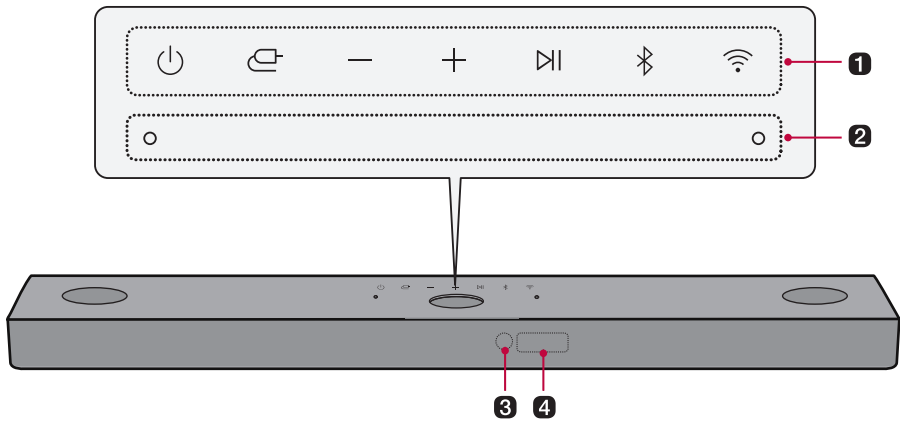

1 Power

This turns the product on/off.

- If you press and hold the **Power**  button for longer than 3 seconds, Wi-Fi will disconnect and the product will no longer emit sound. Press the **Power**  button quickly to maintain the Wi-Fi connection for future use.

Function

Press the button repeatedly to select the desired function or input mode.

- OPT/HDMI ARC: Connects the product to a TV that supports an optical cable, ARC, E-ARC, or LG Sound Sync
- BT: Connects the product via **Bluetooth**
- Wi-Fi: Connects the product via Wi-Fi
- HDMI: Connects the product to an HDMI input port
- USB: Connects the product to a USB storage device

Volume

Adjusts the sound volume.

Play/Pause

This allows you to pause or play music.

Bluetooth pair

It allows you to pair your **Bluetooth** device such as a smartphone to this product within three minutes. (→ See “Connecting via Bluetooth” on page 39.)

Wi-Fi

It goes to the Wi-Fi function directly.

2 Built-in microphone

This is used when operating the Room Calibration on **LG ThinQ app**.

3 Remote Control Receiver

This receives wireless signals from the remote control.

4 Status display

Options such as input mode and volume are displayed in text.

- The status display can be controlled as auto, on, and off. (→ See "Using Display" on page 29.)
-

✔ Note

- To reduce power consumption, the product will automatically turn off after 15 minutes of no input signal from an external device.
-

Back

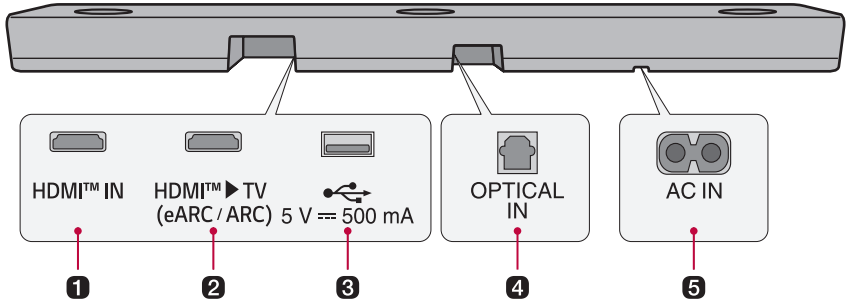

1 HDMI™ IN

Plug in an HDMI cable to connect an external device to the product.

2 HDMI™ ► TV (eARC / ARC) 5 V 500 mA

Plug in an HDMI cable to connect the TV to the product.

3 USB port

Plug in a USB storage device to play music with the product.

4 OPTICAL IN

Plug in an optical cable to connect the TV to the product.

5 AC IN

Plug in the power cord.

Exploring Remote Control

You can use the remote to control all functions of the product, from turning the power on/off to enabling cinematic sound.

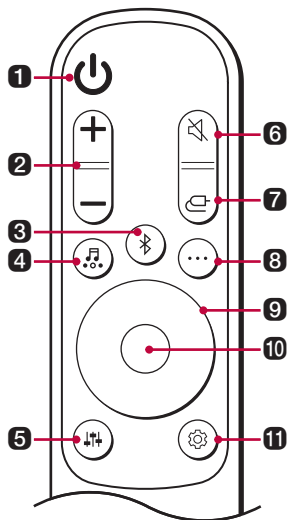

Replacement of Battery

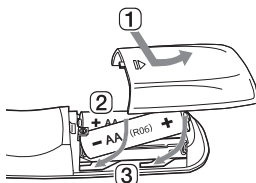

Use AA 1.5V batteries. Replace the two batteries by inserting them into the remote control in accordance with the directions indicated.

- 1 Open the battery cover on the back of the remote control.
- 2 Insert the batteries with the + and - ends corresponding to the markings.
- 3 Close the battery cover.

Risk of fire or explosion if the battery is replaced by an incorrect type.

1 Power

Turns the product on/off.

2 Volume

Adjusts the sound volume.

3 Bluetooth pair

It allows you to pair your **Bluetooth** device such as a smartphone to this product within three minutes. (→ See "Connecting via Bluetooth" on page 39.)

4 Sound Effects

Press the button to select the desired sound field.

- AI SOUND PRO: Artificial intelligence selects the optimal sound settings to suit your content.
- STANDARD: You can enjoy optimised sound.
- CINEMA: Play content with 3D sound similar to a movie theater.
- CLEAR VOICE PRO: Improves the clarity of voices.
- SPORTS: Realistic sound like in a stadium.
- MUSIC: You can enjoy better sound optimised for music.
- GAME: Optimised sound for playing games.
- BASS BLAST (BASS BLAST+): Bass sounds are enhanced.

5 Sound Tuning

This adjusts the sound level of the connected speaker. Press the **Sound Tuning**  button and then **Left/Right** button to select the desired speaker before you press the **Up/Down** button to increase/decrease the sound volume. Adjustable speakers and adjustment ranges are as follows:

- WF (Subwoofer): -15 - 6
 - C (Centre speaker): -6 - 6
 - OVC (Top speaker): -6 - 6
 - R (Rear Speaker): -6 - 6
 - TRE (treble): -6 - 6
 - MID (middle) : -6 - 6
 - BAS (bass): -6 - 6
 - Adjusting subwoofer and rear speakers level is applied only when the subwoofer and rear speakers are connected.
-

6 Mute 

This turns off the sound from the product.

7 Function 

Press the button repeatedly to select the desired input mode or function.

8 Information 

View the connected input source, Wi-Fi network or **Bluetooth** information.

- Wi-Fi: Connected app name
- BT: Connected **Bluetooth** device name
- OPT/ARC/E-ARC/HDMI: Current sound source
- USB: Current sound filename

9 Up/Down/Left/Right 

These buttons are used to adjust the settings of the convenient functions.

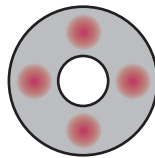

Up/Down: This scrolls through the folders on the USB storage device. You can press the button to select the desired folder.

Left/Right: To play the previous song, press **Left** button. To play the next song, press **Right** button.

10 Play/Pause 

To play or pause a song, press this button.

- When listening to music on a USB storage device, you can select the play mode by pressing the button for 3 seconds or longer, then press **Up/Down** to select the desired Repeat option.
 - OFF: Plays the files in order, then ends playback
 - ONE: Plays the current file repeatedly
 - FOLDER: Only plays the files in the folder on a loop
 - ALL: Plays all files on a loop
 - SHUFFLE: Plays a random file until all files are played, then ends playback

11 Settings

It allows you to adjust the settings of this product: AUTO POWER, SURROUND, NIGHT TIME, DISPLAY. Press **Settings**  button and select the setting by using **Left/Right** button before you press the **Up/Down** button to turn on/off the setting.

- **AUTO POWER:** When the TV or an external device is turned on or off, the product will also turn on or off automatically. It is available only when the product is connected to the TV via an optical cable or **Bluetooth**. (→ See "Using Auto Power" on page 27.)
 - **SURROUND:** The surround sound function allows you to hear immersive 3D sound produced by multiple audio channels from the speakers, regardless of the channels in the originally recorded content. (→ See "Turning surround sound on/off" on page 11.)
 - **NIGHT TIME:** This reduces the general sound volume, but raises the volume of soft and delicate sounds. This is useful when enjoying music or a movie late at night. (→ See "Using Night Time" on page 28.)
 - **DISPLAY:** The status display can be controlled as auto, on, and off. (→ See "Using Display" on page 29.)
-

Various settings for convenience

Convenient functions

Using Auto Power

This function automatically turns the product on or off when the TV or external device is turned on or off.

When the connected device is turned on, the product turns on automatically and selects a function according to the input signal.

Activating/Deactivating the Auto Power function

- 1 Press **Settings**  button. The product enters the setting mode and you can see "OFF-AUTO POWER" or "ON-AUTO POWER".

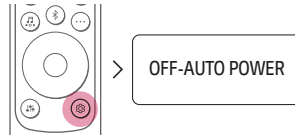

- 2 While the "OFF-AUTO POWER" or "ON-AUTO POWER" is scrolling in the status display, press **Up/Down** button to turn on or off the Auto Power function.

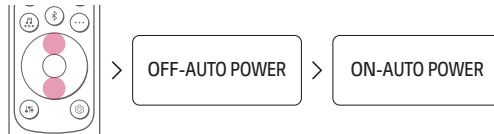

Using Night Time

This reduces the general sound volume, but raises the volume of soft and delicate sounds. This is useful when enjoying music or a movie late at night.

Activating/Deactivating the Night Time function

- 1 Press **Settings**  button. The product enters the setting mode and you can see "OFF-AUTO POWER" or "ON-AUTO POWER".

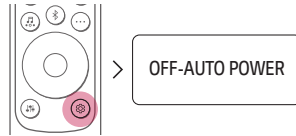

- 2 While the "OFF-AUTO POWER" or "ON-AUTO POWER" is scrolling in the status display, press **Left/Right** button to select the Night time setting. You can see the status of the Night time, "ON-NIGHT TIME" or "OFF-NIGHT TIME".



- 3 While the "ON-NIGHT TIME" or "OFF-NIGHT TIME" is scrolling in the status display, press **Up/Down** button to turn on or off the Night time.



Using Display

The status display can be controlled as auto, on, and off.

Option	Status display
AUTO	Dimmed after 20 seconds of button input.
ON	Always on
OFF	Turned off after 20 seconds of button input.

Activating/Deactivating the Display function

- 1 Press **Settings**  button. The product enters the setting mode and you can see "OFF-AUTO POWER" or "ON-AUTO POWER".

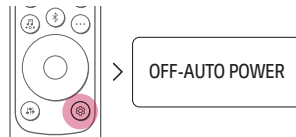

- 2 While the "OFF-AUTO POWER" or "ON-AUTO POWER" is scrolling in the status display, press **Left/Right** button to select the Display setting. You can see the status of the Display, "AUTO-DISPLAY", "ON-DISPLAY" or "OFF-DISPLAY".



- 3 While the "AUTO-DISPLAY", "ON-DISPLAY" or "OFF-DISPLAY" is scrolling in the status display, Press **Up/Down** button to change the Display to "AUTO" or turn it on or off.

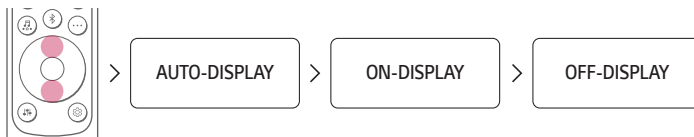

Connecting to the TV

Connecting with an Optical Cable

Transmit your TV's audio to the product by connecting it to the TV with an optical cable. You can add a variety of 3D effects to the original audio to fill the room with a deep, rich sound.

Watching TV after connecting with an optical cable

- 1 If the digital cable terminal has a cover, first remove the covers from both ends.

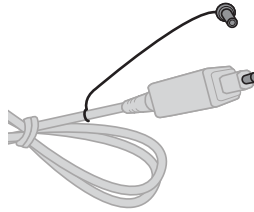

- 2 Using an optical cable, connect the **OPTICAL IN** terminal on the back of the product to the **Optical Digital Output (OPTICAL OUT)** terminal on the TV as shown in the picture.

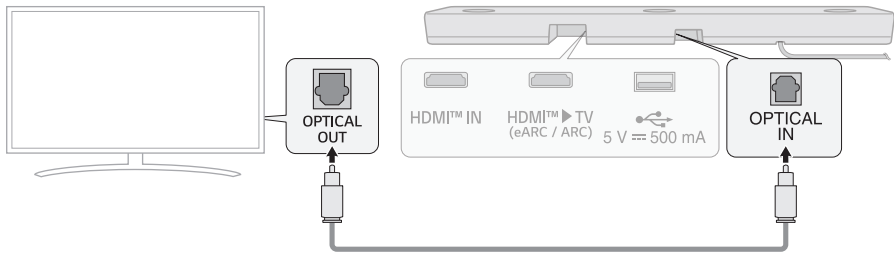

- 3 Press the **Function**  button repeatedly until **"OPT/HDMI ARC"** appears on the status display.

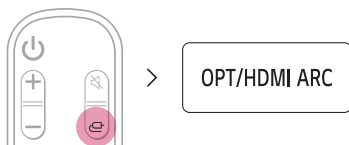

- 4 Press the **Settings** button on the TV remote control to enter the [Speaker] menu and set the output speaker to [Optical] or [External Speaker]. Settings and menu items may vary depending on the TV manufacturer.

✔ **Note**

- If the optical input signal and the ARC signal attempt to connect at the same time, the ARC signal will take priority.

When you use an LG TV

You can adjust the volume with the LG TV remote control if the TV is connected to the product with an optical cable. You can only do so on a TV that supports the LG TV Sound Sync function. Check your TV's user manual to see if your TV is supported.

Functions controllable with an LG TV remote control

Volume, mute on/off

✔ **Note**

- When the TV is properly connected to the product, **"LGOPT"** will appear on the status display.
- When using the product with an LG TV remote control, the volume and mute status set on the TV will automatically be applied to the product.
- You can still use the product's remote control even after connecting it to an LG TV.
- To use LG Sound Sync, you may have to change the sound setting of your TV. It may vary depending on the TV.

Connecting with an HDMI Cable

You can transmit TV audio to the product by connecting the TV to the product with an HDMI cable. Add a variety of 3D effects to the original audio to fill the room with a deep, rich sound.

Watching TV after connecting with an HDMI cable

- 1 Using the HDMI cable, connect the **HDMI™ ► TV (eARC / ARC)** terminal on the back of the product to the **HDMI IN (ARC)** terminal on the TV as shown in the picture.

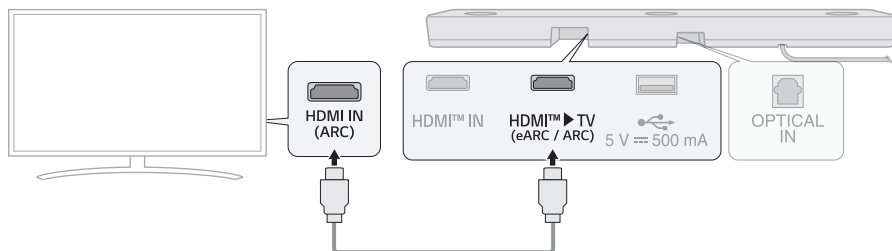

- 2 Press the **Function** button repeatedly until **"OPT/HDMI ARC"** appears on the status display.

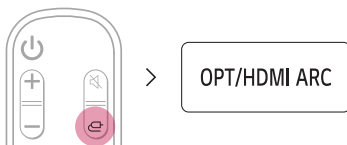

- 3 Press the **Settings** button on the TV remote control to enter the [Speaker] menu and set the output speaker to [HDMI ARC]. Settings and menu items may vary depending on the TV manufacturer.
- 4 When the TV is properly connected to the product, **"ARC"** or **"E-ARC"** will appear on the status display.

✓ Note

- E-ARC supports high-quality audio such as DTS-HD Master Audio™, DTS:X®, Dolby TrueHD, and Dolby Atmos®.
- If you wish to use Dolby Atmos® or DTS:X®, the connected device and its content should support Dolby Atmos® or DTS:X®.
- Ensure that your TV supports the eARC function before you turn on eARC from the **Settings** menu. For more information on how to use this function, please refer to your TV's user manual. Settings may vary depending on the TV.
- Use a certified cable with the HDMI logo.

SIMPLINK

- SIMPLINK refers to the HDMI-CEC function that allows you to use a single TV remote control to easily operate an audio device or player connected to an LG TV via HDMI.
 - Functions controllable with a SIMPLINK-compatible LG TV remote control: Power on/off, volume control, mute on/off, etc.
- For more information on how to set up SIMPLINK, consult your LG TV's user manual.



✔ Note

- The SIMPLINK function may not work properly depending on the status of the product or other connected devices.
 - HDMI-CEC features by TV manufacturer: LG SIMPLINK, Sony BRAVIA Sync/Link, Philips EasyLink, Samsung Anynet+, etc.

Using WOW Orchestra with LG TV

The combination of the LG soundbar and the LG TV gives you the best listening experience to output sound simultaneously through both of them.

This function is automatically activated when the soundbar is connected to the TV and you can choose it on the sound out menu on the TV.

✔ Note

- Available on some LG TV and soundbar models.
- It operates according to the audio codec supported by the TV.
- This function only works when the TV is connected with an HDMI cable or when a TV that supports the LG WOWCAST built-in function is connected.
- Be sure to enable e-ARC on the TV.
- The messages displayed on the TV may differ depending on the model.
- Refer to the TV's instruction manual for more details on settings.

Using PSW mode with WOW Orchestra

PSW (Personalized Sound Wizard) mode is a personalized sound mode provided by LG TV and can be enjoyed in the WOW Orchestra function.

With the personalized sound mode provided by LG TV, the user-selected sound source is analyzed with artificial intelligence deep learning technology to set it as the preferred optimal sound.

✔ Note

- Refer to the TV's instruction manual for more details on settings.
-

Connecting via Bluetooth

Bluetooth is a technology that wirelessly connects electronic products around you. Connect the product to a TV via **Bluetooth** and enjoy your TV audio in high quality.

Watching TV after connecting it wirelessly

1 Press the **Bluetooth pair**  button. After a moment, “**BT READY**” appears on the status display.



2 Press the **Settings** button on the TV remote control and enter the [Speaker] menu to set the output speaker to [**Bluetooth**].

3 Find and select “LG_Speaker_S80TR_XXXX”.

4 When the product is connected to the TV via **Bluetooth**, you can see the status display change from “**PAIRED**” (Connected) → “**Connected TV name**” → “**BT**” (Ready to use).

✔ Note

- For **Bluetooth** devices, characters that cannot be displayed (ex. Korean Hangul) are shown as ‘-’ on the product status display.
- Press the **Information**  button on the remote control to check the name of the connected **Bluetooth** device. You will see the name of the connected **Bluetooth** device appear on the status display.

Connecting to an External Device

Connecting with an HDMI Cable

Connect the TV and external device (game console, DVD player, etc.) with an HDMI cable and enjoy a deep and rich sound.

Connecting an external device via HDMI A

- 1 Connect an external device such as a DVD or Blu-ray player. Following the picture below, connect the **HDMI OUT** terminal of the device to the **HDMI™ IN** terminal on the back of the product.
- 2 Using the HDMI cable, connect the **HDMI™ ▶ TV (eARC / ARC)** terminal on the back of the product to the **HDMI IN (ARC)** terminal on the TV.

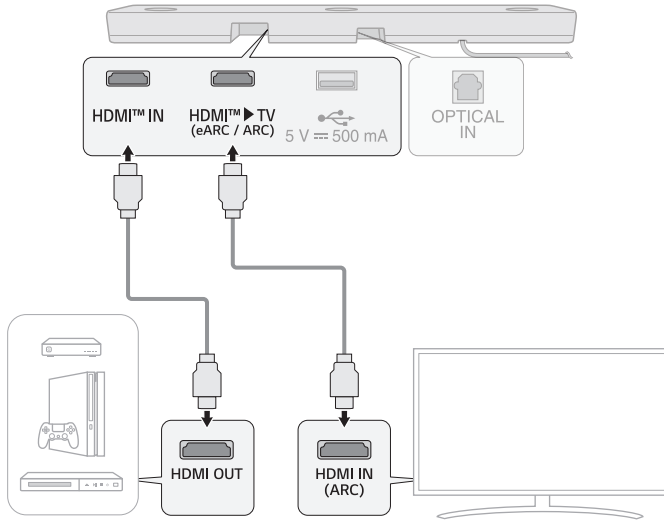

- 3 Press the **Function**  button repeatedly until **"HDMI"** appears on the status display.



- 4 When the external device is properly connected to the product, you can listen to the sound of the device. When playing the video with Dolby Atmos® or DTS:X® technology, either **"DOLBY ATMOS"** or **"DTS:X"** will appear on the status display.

✓ **Note**

- Dolby Atmos® or DTS:X® audio supports 3.1.3 channels. When the wireless rear speakers are connected, 5.1.3 channels are supported.
 - Please check the audio output settings in the Settings menu of your external device (ex. Blu-ray player or TV). The audio output should be set to [No encoding], [Bitstream], [Auto], or [Pass through]. For more information on how to set the output, please refer to your external device's user manual.
 - Use a certified cable with the HDMI logo.
-

Connecting an external device via HDMI **B**

- 1 Connect an external device such as a Set-top box, DVD or Blu-ray player. Following the picture below, connect the **HDMI OUT** terminal of the device to the **HDMI IN** terminal on the TV.
- 2 Using the HDMI cable, connect the **HDMI™ ► TV (eARC / ARC)** terminal on the back of the product to the **HDMI IN (ARC)** terminal on the TV.

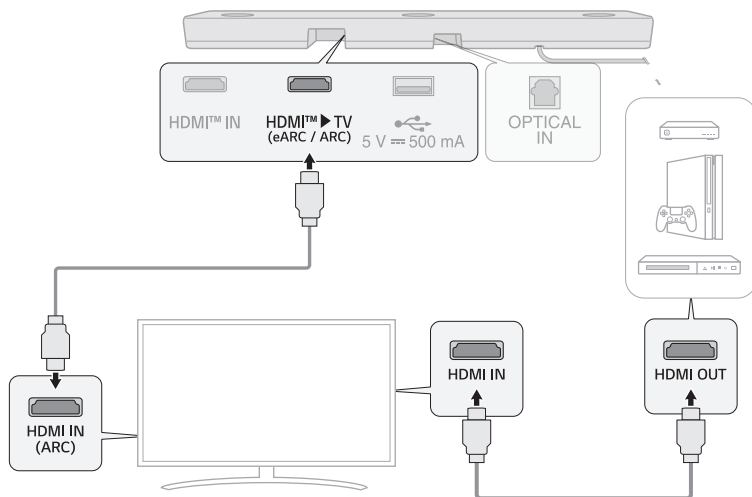

- 3 Press the **Function**  button repeatedly until **"OPT/HDMI ARC"** appears on the status display.

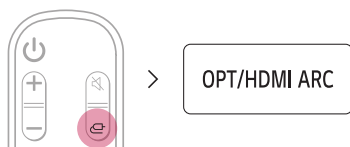

- 4 When the external device is properly connected to the product, you can listen to the sound of the device.

✓ Note

- There may be no sound depending on the specifications of the connected TV. It is recommended to connect the external device directly to the product. (→ See "Connecting an external device via HDMI A" on page 35.)

Connecting with an Optical Cable

Connect the TV and external device (game console, DVD player, etc.) with an optical cable and enjoy a deep and rich sound.

Connecting an external device via optical cable

- 1 Use the optical cable to connect the **OPTICAL IN** terminal on the back of the product to the **OPTICAL OUT** terminal of your external device (ex. TV, Blu-ray player) as shown in the picture.

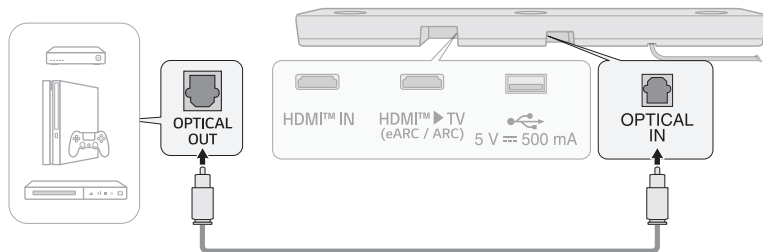

- 2 Press the **Function** button repeatedly until **"OPT/HDMI ARC"** appears on the status display.

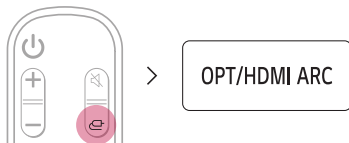

- 3 When the external device is properly connected to the product, **"OPT"** will appear on the status display.

Using the Product as an Audio System

Connecting via Bluetooth

You can play music files stored on a **Bluetooth** device, or run music apps to enjoy the music with this product.

Please check the following first.



- **Bluetooth** devices to be connected to the product should meet the following specifications.
 - **Bluetooth** 5.1 technology
 - Codec: SBC, AAC
- Steps to connect the device to the product may vary depending on the **Bluetooth** device type and model. For more information on how to connect the device, please refer to your external device's user manual.

Select the [**Bluetooth**] from your smartphone's **Settings** menu.

Settings menu items may vary depending on your smartphone manufacturer and model.

- 1 Turn on the product.
- 2 Press the **Bluetooth pair**  button. After a moment, "BT READY" appears on the status display.



- 3 Tap the **Settings**  /  button on your smartphone and select **Bluetooth**.

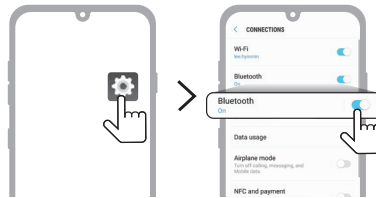

(Android Phone)

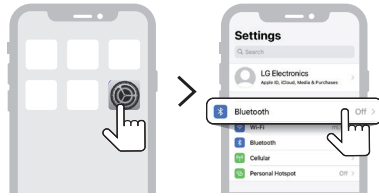

(iPhone)

- 4 Turn on the **Bluetooth** function. (Off > On)
- 5 You will see a list of connectable devices on your smartphone. Find and select “LG_Speaker_S80TR_XXXX”.



- 6 When the product is connected to the smartphone via **Bluetooth**, you will see the status display change from “**PAIRED**” (Connected) → “**Connected Bluetooth device name**” → “**BT**” (Ready to use).
- 7 If you cannot find the product “LG_Speaker_S80TR_XXXX”, tap the **Refresh** (🔄) button at the top right of the screen on the Android smartphone or turn the **Bluetooth** off and turn it on again on iPhone.

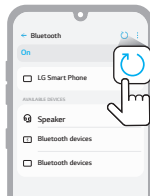

(Android Phone)

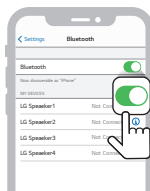

(iPhone)

- 8 Run a Music app and listen to music on the smartphone.



✓ Note

- The closer the **Bluetooth** device is to the product, the better your connection.
 - If you pressed the **Bluetooth pair** (📶) button of the product and selected the "**BT**" option, but could not connect to the **Bluetooth** device, you will see "**BT READY**" on the status display. Check the status of the **Bluetooth** device.
 - When using **Bluetooth**, you should adjust the volume level to an appropriate level.
 - In the **Bluetooth** name of this product "LG_Speaker_S80TR_XXXX", "XXXX" is randomly generated four-digit numbers and alphabets.
-

Connecting to a USB Storage Device

Enjoy high-quality sound by connecting a USB storage device containing music files to the product.

Connecting the product to a USB storage device

- 1 Plug the USB storage device into the **USB** port on the back of the product.
 - The product cannot play any devices connected via a USB storage device hub or a USB storage device cable.
 - The product cannot be connected to any USB storage device, USB type MP3 player, or card reader that requires a separate device driver to be installed.

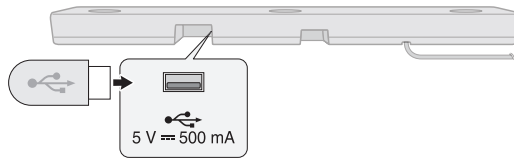

- 2 Press the **Function** button repeatedly until "USB" appears on the status display.

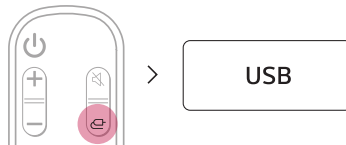

- 3 When the product is properly connected to a USB storage device, the number of music files in the USB device will appear on the status display. Press the **Play/Pause** button on the remote control to enjoy the music.

Note

- It is recommended that you purchase a separate USB gender changer to make it easier to plug in and out USB storage devices.
- Purchase a USB gender changer with a USB 2.0 extension cable.
- USB devices with a large storage volume may take several minutes to browse through files.
- LG Electronics is not responsible for any data loss. Please always back up the data on your USB storage device to minimise damage caused by data loss.
- Only FAT16/FAT32/NTFS formats are supported. exFAT format is not supported.
- Use the USB port of this product only for playing a media file. You cannot charge external devices with the USB port.

USB storage devices supported

- MP3 player
- Flash MP3 player
- USB flash device
- USB 2.0

This product may not recognise some USB storage devices.

Playable file specifications

File extension	Sampling frequency / Bitrate
MP3	32 kHz - 48 kHz / 8 kbps - 320 kbps
AAC	32 kHz - 48 kHz / 8 kbps - 320 kbps
OGG	32 kHz - 48 kHz / 64 kbps - 320 kbps

File extension	Sampling frequency
FLAC (16 bit/24 bit)	32 kHz, 44.1 kHz, 48 kHz, 88.2 kHz, 96 kHz, 176.4 kHz, 192 kHz
WAV (16 bit/24 bit)	32 kHz, 44.1 kHz, 48 kHz, 88.2 kHz, 96 kHz, 176.4 kHz, 192 kHz

- Number of playable files: Up to 2,000
- Maximum number of directories: Up to 200
- This product cannot play files protected by DRM (Digital Rights Management).
- This product cannot play video files from a USB storage device.

Using the LG ThinQ app

Controlling device functions

Run the **LG ThinQ app**. You can easily set [Sound Effect] and [Night Time] and adjust the level of each speaker without a remote control.

Tap the **Settings**  button on the first screen to change the settings of the soundbar.



Using Room Calibration

This technology allows you to analyse the sound coming from the product and fine-tune the audio settings. Please note that, when you start Room Calibration, the product may make a louder sound than expected.

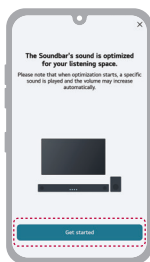

✔ Note

- Some menus can be added to the home card, so you can use the menu more accessible.

Please check the following first.

- Be aware that some features, specifications, applications, services and/or content (“Features”) may not be available in some countries. The Features may vary by country and are subject to change without notice. The Features may not be available in some languages. Please refer to lg.com for service status by country.

Compatible with Google Assistant

Control your device using just your voice with help from Google Assistant.

If you have a compatible Google Assistant-enabled device with Google Cast, you can add this device in your Google Home app. You will be able to play, skip, or stop music, and change the volume - just ask Google Assistant.

Requirements

- Google Assistant-enabled device (Sold Separately)
- This product must be connected to the Internet.
- This product must be set up in the **Google Home** app.



Using Google Cast™

You can listen to your favourite music on this product using hundreds of Google Cast-enabled apps on your phone, tablet or laptop.



Simply tap the **Cast** button from apps you already know and love. No new logins or downloads required. Use your phone to search, play, pause and turn up the volume from anywhere in the home.

For more information on Google Cast, including a list of Google Cast-enabled apps you can cast from, visit g.co/cast/audio

To set up multiroom with other Google Cast-enabled speakers, download the **Google Home** app.

Works with Apple AirPlay

This product allow you to listen to the music from your iOS device through AirPlay.

✓ Note

- Make sure that this product and your iOS device are connected to the same Wi-Fi network.
- Make sure that your iOS device is running iOS 11.4 or later.
- The AirPlay 2-Enabled Speakers are needed to stream to multiple speakers.

Wi-Fi network setting with iOS device

- 1 Turn on the product by pressing the **Power**  button.
- 2 On your iOS device, select the **Settings** and then **Wi-Fi**.
- 3 Select "LG_Speaker_S80TR_XXXX" on the **SET UP NEW AIRPLAY SPEAKER**.
- 4 Make sure your home router is selected. In this step, you can change the product's name of your choice and also you can set up a password. After completing the settings, select the **Next**.
- 5 Select **Done**.



Stream music through AirPlay

From the Control Centre:

- 1 Open the Control Centre on your iOS device.
- 2 Tap AirPlay (📶).
- 3 Choose your product to listen to music. You can choose one or more AirPlay 2 -enabled speakers.

From a music player app:

- 1 Open a music player app.
- 2 Tap AirPlay (📶).
- 3 Choose your product to listen to music. You can choose one or more AirPlay 2 -enabled speakers.



Apple®, AirPlay®, iPad®, iPad Air®, iPad Pro® and iPhone® are trademarks of Apple Inc., registered in the U.S. and other countries.

Use of the Works with Apple badge means that an accessory has been designed to work specifically with the technology identified in the badge and has been certified by the developer to meet Apple performance standards.

To control this AirPlay 2-enabled speaker, iOS 11.4 or later is required.

| Spotify Connect

Use your phone, tablet or computer as a remote control for Spotify. Go to spotify.com/connect to learn how.



The Spotify Software is subject to third party licenses found here: <https://www.spotify.com/connect/third-party-licenses>.

Works with Alexa

Alexa lets you use your voice to control this product by speaking commands through an Alexa Built-in device. Alexa Built-in device is sold Separately.

Alexa setup flow

Run the **LG ThinQ app** and tap **amazon alexa** button on the first screen and then follow the instructions.



How to use Alexa

- **Explicating targeting:** Through Alexa Built-in devices (e.g. Amazon Echo), you can ask Alexa to play music on your [S80TR]. For example, "Alexa, play jazz on [LG S80TR Soundbar]".
- **Preferred Speaker:** You can set one or more speakers so specific devices within a Smart Home Group plays music. You can set a speakers using the Alexa app.
- **Music casting from Alexa app:** You can control music playback to your [S80TR] remotely from the Alexa app.

Amazon, Alexa and all related logos are trademarks of Amazon.com, Inc. or its affiliates.

✔ Note

- This service is provided by Amazon and can be terminated at any time. LG does not assume responsibility for service availability.
- Amazon Alexa app screen is subject to change without prior notice.
- This feature may not be available in some countries.
- For more information, visit the web site
 - <https://www.amazon.com/gp/help/customer/display.html?nodeId=202207000>

Mounting the Product to a Wall

Checking before mounting to a wall

You can mount this product and wireless rear speakers onto a wall.

When mounting the product and wireless rear speakers to the wall, follow the instructions below.

Please check the following first.

- It may be difficult to connect external devices and cables after wall-mounting. First, connect an external device with the proper connection cable to the product before mounting it to the wall.
- Please note the following when you mount the product to the wall. Product damage or injury may occur during the process.
 - Do not put objects on top of the wall-mounted product.
 - Secure the product firmly to the wall using the fixing screws so that it does not fall off.
 - Ensure it is out of the reach of children. Pulling or shaking the mounted product may cause it to fall.
- There are also speakers on the top of the product. When installing the product under the TV, install it 10 cm away from the bottom of the TV.
- When assembling, ensure that all of the provided screws are attached. If the screws are not fully tightened, the product may tilt or tip over, resulting in damage. Tightening the screws with excessive force may cause them to come off due to abrasion of the screw joint.

Components for mounting the product

Soundbar



Wall bracket



Soundbar screws



Wall bracket installation guide



Sold separately

Bracket screws



Wall plugs



✔ Note

- Screws and Wall Plugs are not supplied for mounting the product. We recommend the Hilti (HUD-1 6 x 30) for the mounting.
-

Mounting the Product to a Wall

- 1 Find the wall bracket installation guide in the product package.
- 2 Align the “**TV Bottom Line**” on the wall bracket installation guide with the bottom of the TV, and attach it to the wall. Align the centre of the wall-mounted TV with the part marked “**TV Center**” in the installation guide.

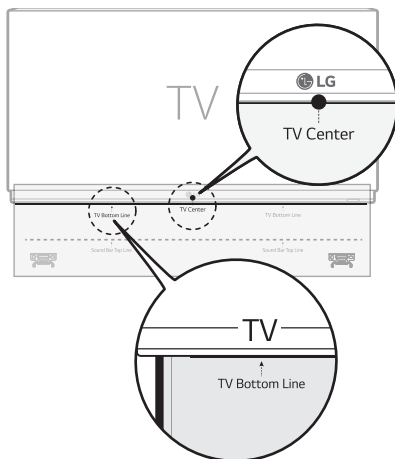

- 3 With a pen, mark screw holes on the installation guide where the wall brackets will be attached.

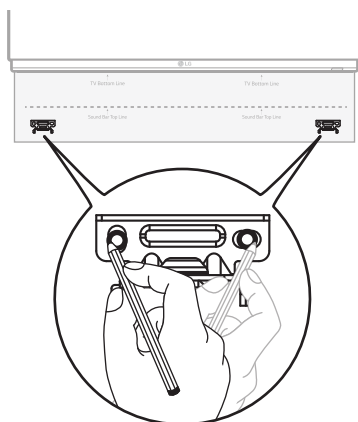

- 4 Drill screw holes in the marked positions on the installation guide.
- 5 Remove the wall bracket installation guide from the wall.

- 6** Fix the brackets firmly to the wall using the wall plugs and screws.

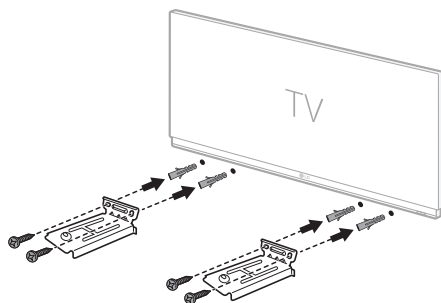

- 7** Place the product on the brackets. Position the product on the brackets so the screw holes on the bottom of the product align with the screw holes on the wall bracket.

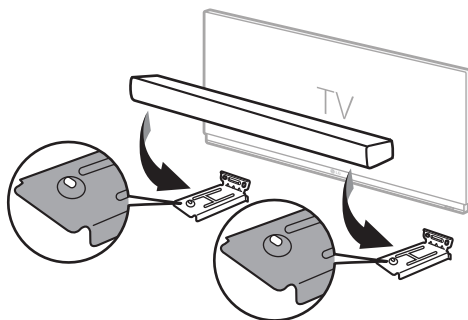

- 8** Firmly attach the product to the wall brackets using the screws provided.

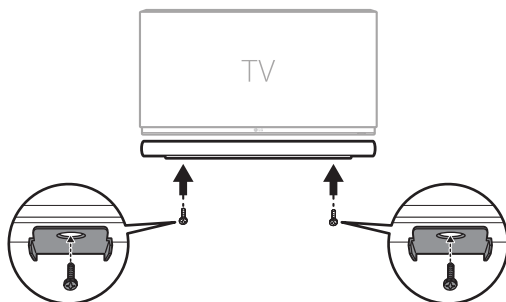

Safety Precautions

| Safety and Regulatory



CAUTION: TO REDUCE THE RISK OF ELECTRIC SHOCK DO NOT REMOVE COVER (OR BACK). NO USER-SERVICEABLE PARTS INSIDE. REFER SERVICING TO QUALIFIED SERVICE PERSONNEL.



This lightning flash with arrowhead symbol within an equilateral triangle is intended to alert the user to the presence of uninsulated dangerous voltage within the product's enclosure that may be of sufficient magnitude to constitute a risk of electric shock to persons.



The exclamation point within an equilateral triangle is intended to alert the user to the presence of important operating and maintenance (servicing) instructions in the literature accompanying the product.

WARNING:

- TO PREVENT FIRE OR ELECTRIC SHOCK HAZARD, DO NOT EXPOSE THIS PRODUCT TO RAIN OR MOISTURE.
- Do not install this equipment in a confined space such as a book case or similar unit.

CAUTION:

- Do not use high voltage products around this product. (ex. Electrical swatter) This product may malfunction due to electrical shock.
- No naked flame sources, such as lighted candles, should be placed on the apparatus.
- Do not block any ventilation openings. Install in accordance with the manufacturer's instructions. Slots and openings in the cabinet are provided for ventilation and to ensure reliable operation of the product and to protect it from over heating. The openings should never be blocked by placing the product on a bed, sofa, rug or other similar surface. This product shall not be placed in a built-in installation such as a bookcase or rack unless proper ventilation is provided or the manufacturer's instruction has been adhered to.
- The apparatus should not be exposed to water (dripping or splashing) and no objects filled with liquids, such as vases, should be placed on the apparatus.
- For safety marking information including product identification and supply ratings, please refer to the main label on the bottom or the other surface of the product.
- Be careful to make sure children do not put their hands or any objects into the *speaker duct.
 - * speaker duct: A hole for plentiful bass sound on speaker cabinet. (enclosure)

CAUTION concerning the Power Cord

The Power Plug is the disconnecting device. In case of an emergency, the Power Plug must remain readily accessible.

Check the specification page of this owner's manual to be certain of the current requirements.

Do not overload wall outlets. Overloaded wall outlets, loose or damaged wall outlets, extension cords, frayed power cords, or damaged or cracked wire insulation are dangerous. Any of these conditions could result in electric shock or fire. Periodically examine the cord of your device, and if its appearance indicates damage or deterioration, unplug it, discontinue use of the device, and have the cord replaced with an exact replacement part by an authorised service centre.

Protect the power cord from physical or mechanical abuse, such as being twisted, kinked, pinched, closed in a door, or walked upon. Pay particular attention to plugs, wall outlets, and the point where the cord exits the device.

For models using an adapter

Only use the AC adapter supplied with this device. Do not use a power supply from another device or another manufacturer. Using any other power cable or power supply may cause damage to the device and void your warranty.

For models using a battery

This device is equipped with a portable battery or accumulator.

CAUTION: Risk of fire or explosion if the battery is replaced by an incorrect type.

For models using a built-in battery

Do not store or transport at pressures lower than 11.6 kPa and at above 15,000 m altitude.

- replacement of a battery with an incorrect type that can defeat a safeguard (for example, in the case of some lithium battery types);
- disposal of a battery into fire or a hot oven, or mechanically crushing or cutting of a battery, that can result in an explosion;
- leaving a battery in an extremely high temperature surrounding environment that can result in an explosion or the leakage of flammable liquid or gas;
- a battery subjected to extremely low air pressure that may result in an explosion or the leakage of flammable liquid or gas.

Symbols

~ : Alternating current (AC).

≡ : Direct current (DC).

⊞ : This is a class II equipment.

⏻ : Standby power state.

⏻ : The power is turned on.

⚡ : Danger voltage.

Prevention of product misuse

To prevent misuse of the product, please be sure to check the contents below.

Precautions for installing the product

- Do not install the product in an unstable or vibrating place, such as on a shaking shelf or inclined surface. Install the product on a firm and level surface.
 - Otherwise, the product may fall or tip over and cause injury.
 - If you install the product on an unstable surface, the product may not work properly.
- If you install the product on a piece of furniture or shelf, make sure that the bottom front of the product does not protrude. Always use a piece of furniture or shelf that fits the product size.
 - Otherwise, the product may lose its balance and fall, causing injury or product damage.
- Install the product in a safe place. Otherwise, a child may bump into an edge of the product and get injured.
- Install the product in a place free from electromagnetic interference for proper operation.
- If you install the product in a place that does not meet the general use conditions, an unexpected quality problem may arise. So, make sure that you contact the service centre first before installing the product in such a place.
- Do not keep the product in a place where the temperature is too high (above 40 °C) or too low (below 5 °C) or a place with too much humidity.
- Avoid places exposed to direct sunlight or heat, e.g., near a heater. Do not use or keep flammable sprays or substances near the product.
 - Otherwise, there is a risk of explosion or fire.
- Do not install the product in a place with too much moisture, dust or soot.
 - Otherwise, it may cause a fire or electric shock.
- Do not install the product in a narrow space, such as inside a bookshelf, that does not ventilate well. Do not cover the product with a table cover or curtain.
 - Otherwise, it may increase the product temperature, causing a breakdown or fire.
- Connect the power plug of the product to a power outlet that is easily accessible.
 - When a fire or other problem occurs in the product, you must be able to remove the power plug quickly.
- Do not connect multiple products to one power outlet at the same time.
 - Otherwise, it may cause overheating, resulting in a fire.

Precautions for using the product

- Do not lift or move the product while it is operating.
 - Otherwise, it may cause a breakdown.
- When moving the product, pull out the power cord and all cables connected to the product.
 - Otherwise, it may cause a fire or electric shock.
- Stop using the product immediately if you notice smoke or a strange odor. In this case, turn off the power immediately, disconnect the power plug, and contact the service centre.
 - Using the product in this state may result in a fire or electric shock.
- Do not insert metal objects such as coins and hairpins or flammable objects such as paper and matchsticks into the product. Make sure that you tell any children not to do so.
 - Otherwise, it may cause a breakdown.
- If a foreign substance is inserted into the product, disconnect the power plug and contact the service centre.
- Do not put a heavy object on top of the product.
 - Otherwise, it may tip over or fall, causing injury.
- Make sure that a child does not hang on the product or get on it.
 - Otherwise, the product may tip over or fall, causing injury. Make sure that you tell any children not to do so.
- Remove the power plug during thunderstorms.
 - Otherwise, it may cause a fire.
- Do not place vessels with liquid, such as a vase, pot, cosmetics, or medicine, on top of the product.
 - Otherwise, it may result in a fire, electric shock, or injury due to its fall, etc.
- Make sure that you connect the power plug firmly. Do not use voltage other than the rated voltage indicated on the product.
 - An insecure connection may result in a fire.
- Do not insert a conductor, such as chopsticks, into the groove on the other side of the product while the power plug is connected to an outlet. Do not touch the power plug immediately after unplugging it from the outlet.
 - Otherwise, it may cause electric shock.
- Hold the power plug with dry hands.
 - Otherwise, it may cause electric shock.
- Do not move or push the product while holding a product cable such as a power cord.
 - The cable may get damaged and cause a breakdown or result in a fire or electric shock.
- When removing a cable plugged into the product, make sure that you hold the connector at the end of the cable. Do not hold the cable line.
 - Otherwise, it may result in an injury or the product may fall and cause a breakdown.
- Do not keep the product in a place exposed to heat, e.g., near a heater.
 - Otherwise, it may cause a fire or malfunction.
- Do not disassemble, repair, or modify the product.
 - Otherwise, it may cause a breakdown, resulting in a fire, electric shock, or injury.
- Keep plastic wraps out of reach of toddlers.
 - Otherwise, toddlers may choke on the plastic wraps.
- Do not drop an object on the product or make an impact on it. Keep the product away from places with severe vibrations or magnets.

- Do not damage, modify, bend, twist, or heat a power cord.
 - Otherwise, it can damage the power cord, resulting in a fire or electric shock.
- When you are not using the product for a prolonged period, such as when you are away from home, unplug the power cord from the power outlet.
 - If dust accumulates, it can cause heat, resulting in electric shock or fire due to a short circuit.
- Do not dispose of waste batteries together with regular waste. Dispose of them separately.
 - Otherwise, there is a risk of explosion or fire.
- Do not use high voltage products around this product. (ex. Electrical swatter)
 - This product may malfunction due to electrical shock.
- Do not touch the power plug immediately after unplugging it from the outlet.
 - Otherwise, it may cause electric shock.
- Connect the power plug to a grounded outlet or extension cord. (This does not apply to products without a ground.)
 - Otherwise, it may cause a breakdown or electric shock due to a short circuit.
- In the case of a product with a vent, keeping the product turned on for a prolonged period can result in the vent getting hot. Do not touch the vent when it is hot. The heat is not a fault of the product and does not cause any malfunction. So, you may use the product without worry.
- Do not damage the power cable, AC adapter, or power plug. Do not place a heavy object on top of the power cable or AC adapter.
 - Otherwise, it may cause a fire or electric shock.
- If dust, dirt, etc. is found on the power plug pins, an AC adapter, or a power outlet, wipe it completely.
 - Otherwise, it may cause a fire.
- In the case of a product with a power cord or AC adapter, use only genuine power cords and AC adapters provided by LG Electronics.
 - Otherwise, it may cause a fire or electric shock.
- If you are using headphones or earphones, do not turn on the volume too loudly or use them for a prolonged period. [This only applies to models that support headphones or earphones]
 - Otherwise, it may negatively affect your hearing ability.
- The software of this product can be updated. Do not turn off the power of the product while updating the software. Once the update is complete, the product power turns off automatically.
 - If you turn off the power of the product while the software is being updated, it may cause a product malfunction.

The following only applies to models with a remote control

- Do not let children use the remote control. Keep the remote control out of reach of toddlers.
- Do not let children put the remote control in their mouth. Make sure that children don't swallow the remote control cover or a battery. If a child swallowed one, consult a physician immediately.
- Beware that children may step on the remote control cover and get injured.
- Remove obstacles between the product and the remote control for the smooth operation of the remote control.

The following only applies to models that use optical discs

- Do not insert your hand into a disc drive or pull it out forcefully.
- Make sure that children do not insert their hands into the disc drive.

The following only applies to models that able to watch video

- Refrain from watching a 3D video if you didn't have enough sleep or after drinking alcohol.
 - Some 3D videos may surprise or excite people.
- If any of the following symptoms occur while watching a video, stop watching it immediately and take a rest.
 - If any of the symptoms continue, consult a physician. Vertigo, burning sensation of eyes or face, unconscious motion, spasm, clouded consciousness, confusion, disorientation, nausea.
- You may suffer a symptom such as a seizure when you watch a certain image in a video or game or a video with a certain pattern or flashing lights. If you or any of your relatives have a history of epilepsy or seizures, consult a physician before watching.
- When you watch a 3D video, remove objects that are fragile or can cause injury from your surroundings.
 - If you mistake a 3D video as real or move your body with surprise, you or your nearby relatives may get injured or objects near you may get damaged.

Precautions for cleaning the product





- Do not spray water directly onto the product when cleaning it.
 - Otherwise, it may cause a fire or electric shock.
- When cleaning the product, make sure that you pull out the power cord first and wipe the surface of the product lightly with a dry cloth. Do not use chemicals or detergents when cleaning the product. They may deteriorate the product surface or peel off the paint from the product (benzene, alcohol, etc.).

Before Reporting Product Malfunction

Troubleshooting

If you experience the following issues while using the product, please perform several checks, as they may not be malfunctions.

General Errors

Issue	Solution
The product does not work properly	<ul style="list-style-type: none">• Unplug the power cables and any external devices such as your TV, subwoofer, or amplifier from the product, then plug them in again.• After resetting the product, connect your smartphone and Wi-Fi again. (→ See "Connecting with the product via LG ThinQ app" on page 16.) (Please beware that previous product settings may be lost.)
The power does not turn on	<ul style="list-style-type: none">• Is the power cord plugged into the outlet properly?<ul style="list-style-type: none">- Connect the power plug to the outlet correctly.
There is no sound	<ul style="list-style-type: none">• Is the volume set to minimum?<ul style="list-style-type: none">- Press the Volume   button on the remote control to turn up the volume.- If you are using an external device such as a set-top box, portable device, or Bluetooth device, adjust the volume of the external device.• Is the mute function activated?<ul style="list-style-type: none">- If "MUTE" appears on the status display, the mute function is on. Press the Mute  button to unmute.• Is the correct product function selected according to the external device connected?<ul style="list-style-type: none">- Press the Function  button to check if you selected the correct function.
The subwoofer does not produce sound	<ul style="list-style-type: none">• Is the product properly connected to the wireless subwoofer?<ul style="list-style-type: none">- If the LED on the back of the wireless subwoofer is blinking green or lit in red, it means it is not connected. If the connection is established, a green light will appear. Reconnect the product to the wireless subwoofer. (→ See "Connecting the Product" on page 6.)

The remote control does not work properly	<ul style="list-style-type: none"> • When using the remote control, point it at the front of the product. • Use the remote control within a 7-m radius of the product. • Replace the batteries with new ones as needed.
The Auto Power function does not work	<ul style="list-style-type: none"> • Check connection to external devices (ex. set-top box, portable device, Bluetooth device).
LG Sound Sync does not work	<ul style="list-style-type: none"> • Check whether your TV supports LG Sound Sync. • Check if the TV is properly connected to the product via an optical cable. <ul style="list-style-type: none"> - Press the Settings button on the TV remote control to check if the function is turned on in [LG Sound Sync].
The product volume is low	<ul style="list-style-type: none"> • Check the following and change the settings accordingly. <ul style="list-style-type: none"> - Run the LG ThinQ app, tap the [Sound settings] on the first screen, and change the [DRC] function to [Off] on the [Sound output] menu. - When the product is connected to a TV, press the Settings button on the TV remote control, select the [Speaker] menu, and change the [Digital Sound Output] setting from [PCM] to [AUTO] or [BITSTREAM]. - If the product is connected to a playback device such as a DVD player or Blu-ray disc player, go to the connected device's Settings menu. Change the [Digital Sound Output] setting from [PCM] to [PRIMARY PASS-THROUGH] or [BITSTREAM]. Set the [DRC] of the connected device to [OFF]. - If the product's Night Time mode is on, turn it off by pressing the Settings  button and Left/Right and then Up/Down.
The product fails to recognise a USB storage device	<ul style="list-style-type: none"> • The product may not support the file format of the USB storage device. Format the USB storage device and reconnect it. When formatting, refer to the USB storage device formats supported by the product and select an appropriate file format. (→ See "Connecting to a USB Storage Device" on page 42.)
A Bluetooth device cannot be paired	<ul style="list-style-type: none"> • Press the Settings button on the Bluetooth device and check whether the Bluetooth function is enabled. If Bluetooth is enabled, turn it off and on, then try again. • Remove any obstacles between the product and the Bluetooth device. • Bluetooth pairing (connection) may not work properly depending on the Bluetooth device type or the surrounding environment.

Network Connection Errors

Issue	Solution
The product cannot be connected to the LG ThinQ app	<ul style="list-style-type: none">• The connection may not be smooth when disturbed by other electric appliances that use radio waves, such as microwave ovens and medical equipment. Install the product 1 m away from other home appliances.• Turn off your wireless router and turn it on again.• Check if your smartphone's Wi-Fi function is turned on. You can check the Wi-Fi connection status in your smartphone's settings.• Check if the product and smartphone are on the same Wi-Fi network.

The product does not connect to the Wi-Fi network

- Did you turn off the wireless router and turn it on again?
 - Turn off the product and then turn it on again.
 - Have you installed a new wireless router?
 - You will need to reconfigure the network settings of the product. (→ See "Connecting with the product via LG ThinQ app" on page 16.)
 - Did you change the settings of the wireless router?
 - If the router password contains some special characters (such as ` ' " + / \ ; : - _ ^ & () < >) or emoticons, the soundbar may not be connected. It is recommended to set a password using a combination of English letters and numbers.
 - It is recommended to set the security type of the wireless router to WPA2.
 - Unplug the router and plug it in after 10 seconds. Then try to connect after network recovery.
 - Changing the wireless channel on your router can help reduce wireless interference. (Here is how to change the wireless channel of the most common routers. For the exact details, refer to your router's instruction manual.)
 - ① Enter the IP address on your smartphone, PC, or MAC, or use the setup wizard CD to log into the router setup page. This can only be done when the router is connected to the network via Wi-Fi or an Ethernet cable.
 - ② Find the wireless settings page and change the wireless channel of your 2.4 GHz / 5 GHz network. If the "Auto" channel is enabled, disable it and set up a specific channel.
 - If the router channel is 2.4 GHz, 6 ch / 11 ch
 - If the router channel is 5 GHz, 48 ch / 149 ch
 - ③ Save the settings and restart the wireless router.
 - Remove the power cable from the router, wait 5 seconds, and reconnect the power cable. When the router is completely powered on, try connecting it again.
-





App Errors

Issue	Solution
The app is not working properly	<ul style="list-style-type: none">• Do you get an error when running the app?<ul style="list-style-type: none">- Check if the power of the device is turned on.- Check if the app you wish to run supports the operating system of your smartphone. You can visit the app manufacturer's website to confirm supported operating systems.- Check if you have the latest version of the app. Search for the app on Google Play or the App Store and check if an Update button appears next to it. If it is not the latest version, tap the Update button.• If the error is not resolved yet, try connecting by using another smartphone with the LG ThinQ app installed.
Google Cast is not working properly	<ul style="list-style-type: none">• If Google Cast is not working properly after installing the soundbar, you can resolve it in the LG ThinQ app.<ol style="list-style-type: none">① Make sure your smartphone is connected to the same Wi-Fi network as your TV.② Install and launch the LG ThinQ app.③ After launching the LG ThinQ app, follow the steps below to enable Google Cast function.<ul style="list-style-type: none">- Enter Setting  on the top right of the home screen → Enter 'Google Cast Settings' → Enter 'Activate' → Click the 'Agree' button.
Alexa Log-in is not working properly	<ul style="list-style-type: none">• Do you get an error when you select the Amazon Alexa login on the LG ThinQ app?<ul style="list-style-type: none">- Check if you have installed the LG Soundbar AlexaLoginManager app after downloading it from the Google Play or App Store.- Check if your mobile phone's internet is working properly.- Check if you have entered a valid account and password for Amazon Alexa.★ Please note that this functionality may be limited depending on the Amazon service support policy in specific countries.

Problems in Wireless Connection

Issue	Solution
There is radio interference	<ul style="list-style-type: none">• Install the product and the wireless subwoofer as close to each other as possible.• Do not install the product on metal furniture.• Wireless communication may not work properly in weak signal areas.
The Bluetooth connection is causing a malfunction or making noise	<ul style="list-style-type: none">• Do you hear noise or experience malfunctions when using Bluetooth?<ul style="list-style-type: none">- Do not let any part of your body contact the transceiver of the Bluetooth device or the product.- Do not install the Bluetooth device on a wall or in a secluded spot.- Remove any obstacles between the product and the Bluetooth device.- Install the Bluetooth device near the product.• When the Bluetooth device is too far from the product, Bluetooth may be disconnected or malfunctions may occur.<ul style="list-style-type: none">- Install the Bluetooth device 1 m away from devices that use the same frequency as the product, such as wireless routers, medical equipment, and microwave ovens.

Turning off the Demo Mode

Issue	Solution
The remote control does not work	<ul style="list-style-type: none">• Does the text on the status display remain unchanged, even if you press the Function  button several times?• Do you only see the text "DEMO" in the status display?<ul style="list-style-type: none">- The demo mode may be activated on the product. Unplug the product's power cable and plug it back in.- If the remote control still does not work, press the Volume   button on the product to set the volume level at 2, then press and hold the Function  button for about 5 seconds. If the currently selected function appears on the status display, it means that demo mode has been turned off.

Appendix

Specifications

General	
Power requirements	Refer to the main label.
Power Consumption	Refer to the main label.
	Networked standby: 2.0 W Standby: 0.5 W
Dimensions (W x H x D)	Approx. 1000.0 mm x 63.0 mm x 135.0 mm (including the base)
Operation Temperature Range	5 °C - 40 °C
Operation Humidity Range	5 % - 80 % RH
Bus Power Supply (USB)	5 V  500 mA
Available Digital Input Audio Sampling Frequency	32 kHz, 44.1 kHz, 48 kHz, 88.2 kHz, 96 kHz, 176.4 kHz, 192 kHz
Available Digital Input Audio format	Dolby Digital, Dobby Digital Plus, Dolby TrueHD, Dolby Atmos, DTS Digital Surround, DTS-HD HRA, DTS-HD MA, DTS:X, PCM

Input/Output	
OPTICAL IN	3.0 V (p-p), (optical audio connection terminal) × 1
HDMI™ IN	19-pin (Type A, HDMI™ connection terminal) × 1
HDMI™ ► TV (eARC / ARC)	19-pin (Type A, HDMI™ connection terminal) × 1 4K resolution is supported for 4K sources applied with HDCP 2.3 (supported 4K@120 Hz (YCbCr 4:2:0)).

Amplifier (RMS output)	
Total	580 W RMS
Front	45 W RMS × 2 (Impedance: 4 Ω, THD 10 %)
Centre	40 W RMS (Impedance: 4 Ω, THD 10 %)
Top (Overhead)	45 W RMS × 2 (Impedance: 4 Ω, THD 10 %)
Top centre (Overhead)	40 W RMS (Impedance: 4 Ω, THD 10 %)
Rear	50 W RMS × 2 (Impedance: 4 Ω, THD 10 %)
Subwoofer	220 W RMS (Impedance: 3 Ω, THD 10 %)

Wireless Subwoofer	
Power Requirement	Refer to the main label on the Wireless Subwoofer.
Power Consumption	Refer to the main label on the Wireless Subwoofer.
Type	1-way 1 speaker
Impedance	3 Ω
Rated power	220 W RMS
Max. Power	440 W RMS
Dimensions (W x H x D)	Approx. 201.7 mm x 407.0 mm x 403.0 mm (including the base)

System	
Wireless LAN (Internet antenna)	802.11a/b/g/n Wi-Fi network compatible

Wireless Rear speakers (Each)	
Power Requirement	Refer to the main label on the wireless rear speakers.
Power Consumption	Refer to the main label on the wireless rear speakers.
Type	1-way 1 speaker
Impedance	4 Ω
Rated power	50 W RMS
Max. Power	100 W RMS
Dimensions (W x H x D)	Approx. 100.0 mm x 176.5 mm x 120.0 mm (including the base)

- Design and specifications are subject to change without notice.

| Registered Trademarks and Licenses

All trademarks and trade names are the property of their respective owners.



Dolby, Dolby Vision, Dolby Atmos, and the double-D symbol are registered trademarks of Dolby Laboratories Licensing Corporation. Manufactured under license from Dolby Laboratories. Confidential unpublished works. Copyright © 2012–2021 Dolby Laboratories. All rights reserved.



The **Bluetooth**® word mark and logos are registered trademarks owned by the **Bluetooth** SIG, Inc. and any use of such marks by LG Electronics is under license.

Other trademarks and trade names are those of their respective owners.



The terms HDMI, HDMI High-Definition Multimedia Interface, HDMI Trade Dress and the HDMI Logos are trademarks or registered trademarks of HDMI Licensing Administrator, Inc.



For DTS patents, see <http://patents.dts.com>. Manufactured under license from DTS, Inc. or DTS Licensing Limited. DTS, DTS:X, and the DTS:X logo are registered trademarks or trademarks of DTS, Inc. in the United States and other countries. © 2023 DTS, Inc. ALL RIGHTS RESERVED.

| What You Need to Know about Network Services

All information, data, documents, correspondence, downloads, files, text, images, photos, graphics, videos, webcasts, publications, tools, resources, software, code, programs, applets, widgets, applications, products, and any other content ("Content") and services and offerings ("Services") made available by a third-party are provided under the sole responsibility of the service providers that produced them.

Withholding, removal, or suspension of any or all of these Content and Services are not restricted, and the use of and access to Contents and Services provided through LG Electronics products by the service providers may be changed anytime without prior notice.

If you have any demands or issues regarding Content and Services, you can refer to the service provider's website for the most up-to-date information. LG Electronics is not responsible for consumer services related to Content and Services, and does not undertake any obligations. Any questions or requirements regarding Content and Services should be fulfilled directly by the respective content and service providers.

It is clear that LG Electronics is not responsible for any Content or Services, or any change, removal, or suspension of each Content or Service, and does not certify or guarantee the use of or access to such Content or Services.

| Open Source Software Notice Information

To obtain the source code that is contained in this product, under GPL, LGPL, MPL, and other open source licenses that have the obligation to disclose source code, and to access all referred license terms, copyright notices and other relevant documents, please visit <https://opensource.lge.com>.

LG Electronics will also provide open source code to you on CD-ROM for a charge covering the cost of performing such distribution (such as the cost of media, shipping, and handling) upon email request to opensource@lge.com.

This offer is valid to anyone in receipt of this information for a period of three years after our last shipment of this product.

| Handling the Product

When shipping the Product

Please save the original shipping carton and packing materials. If you need to ship the product, for maximum protection, re-pack the product as it was originally packed at the factory.

Keeping the exterior surfaces clean

- Do not use volatile liquids such as insecticide spray near the product.
- Wiping with strong pressure may damage the surface.
- Do not leave rubber or plastic products in contact with the product for a long period of time.

Cleaning the product

To clean the product, use a soft, dry cloth. If the surfaces are extremely dirty, use a soft cloth lightly moistened with a mild detergent solution. Do not use strong solvents such as alcohol, benzine, or thinner, as these might damage the surface of the product.

