



OWNER'S MANUAL

# Wireless Sound Bar

Please read this manual carefully before operating your set and retain it for future reference.

MODEL

SJ3 (SJ3, SPJ4B-W)



[www.lg.com](http://www.lg.com)

Copyright © 2017 LG Electronics Inc. All Rights Reserved.

# Safety Information



**CAUTION:** TO REDUCE THE RISK OF ELECTRIC SHOCK DO NOT REMOVE COVER (OR BACK) NO USER-SERVICEABLE PARTS INSIDE REFER SERVICING TO QUALIFIED SERVICE PERSONNEL



This lightning flash with arrowhead symbol within an equilateral triangle is intended to alert the user to the presence of uninsulated dangerous voltage within the product's enclosure that may be of sufficient magnitude to constitute a risk of electric shock to persons.



The exclamation point within an equilateral triangle is intended to alert the user to the presence of important operating and maintenance (servicing) instructions in the literature accompanying the product.

**WARNING:** TO PREVENT FIRE OR ELECTRIC SHOCK HAZARD, DO NOT EXPOSE THIS PRODUCT TO RAIN OR MOISTURE.

**CAUTION:** The apparatus should not be exposed to water (dripping or splashing) and no objects filled with liquids, such as vases, should be placed on the apparatus.

**WARNING:** Do not install this equipment in a confined space such as a book case or similar unit.

**CAUTION:** Do not use high voltage products around this product. (ex. Electrical swatter) This product may malfunction due to electrical shock.

**CAUTION:** No naked flame sources, such as lighted candles, should be placed on the apparatus.

**CAUTION:** Do not block any ventilation openings. Install in accordance with the manufacturer's instructions.

Slots and openings in the cabinet are provided for ventilation and to ensure reliable operation of the product and to protect it from over heating. The openings shall be never be blocked by placing the product on a bed, sofa, rug or other similar surface. This product shall not be placed in a built-in installation such as a bookcase or rack unless proper ventilation is provided or the manufacturer's instruction has been adhered to.

**CAUTION concerning the Power Cord**

Check the specification page of this owner's manual to be certain of the current requirements. Do not overload wall outlets. Overloaded wall outlets, loose or damaged wall outlets, extension cords, frayed power cords, or damaged or cracked wire insulation are dangerous. Any of these conditions could result in electric shock or fire. Periodically examine the cord of your device, and if its appearance indicates damage or deterioration, unplug it, discontinue use of the device, and have the cord replaced with an exact replacement part by an authorized service center. Protect the power cord from physical or mechanical abuse, such as being twisted, kinked, pinched, closed in a door, or walked upon. Pay particular attention to plugs, wall outlets, and the point where the cord exits the device. The Power Plug is the disconnecting device. In case of an emergency, the Power Plug must remain readily accessible.

**NOTICE:** For safety marking information including product identification and power supply ratings, please refer to the main label on the bottom or the other surface of the product.

This device is equipped with a portable battery or accumulator.

**Safety way to remove the battery from the**

**equipment:** Remove the old battery or battery pack, follow the steps in reverse order than the assembly. To prevent contamination of the environment and bring on possible threat to human and animal health, the old battery or the battery put it in the appropriate container at designated collection points. Do not dispose of batteries or battery together with other waste. It is recommended that you use local, free reimbursement systems batteries and accumulators. The battery should not be exposed to excessive heat such as sunshine, fire or the like.

## Symbols

~	Refers to alternating current (AC).
≡	Refers to direct current (DC).
⊞	Refers to class II equipment.
⏻	Refers to stand-by.
⏻	Refers to "ON" (power).
⚡	Refers to dangerous voltage.

# Table of Contents

## 1 Getting Started

---

- 2 Safety Information
- 6 Unique features
- 6 Introduction
- 6 – Symbols used in this manual
- 7 Remote control
- 8 Front panel
- 8 Rear panel
- 9 About LED condition
- 10 Installing the sound bar
- 11 Mounting the main unit on a wall

## 2 Connecting

---

- 13 Wireless subwoofer connection
- 14 Connecting to your TV
- 14 – Using an OPTICAL cable
- 14 – LG Sound Sync
- 16 Optional equipment connection
- 16 – OPTICAL IN connection
- 16 – PORT. IN connection
- 17 – USB connection
- 17 – Compatible USB devices
- 17 – USB device requirement
- 18 – Playable file

## 3 Operating

---

- 19 Basic operations
- 19 – USB operation
- 19 Other operations
- 19 – Turn off the sound temporarily
- 19 – Using your TV remote control
- 20 – Auto power down
- 20 – AUTO POWER On/Off
- 21 – Auto function change
- 22 Using BLUETOOTH® technology
- 22 – Listening to music stored on the Bluetooth devices
- 24 Using BLUETOOTH App
- 24 – Install “Music Flow Bluetooth” App onto Your BLUETOOTH Device
- 24 – Activate Bluetooth with “Music Flow Bluetooth” App
- 26 Sound adjustment
- 26 – Setting the surround mode
- 26 – Adjust the woofer level settings
- 26 – Night mode

## 4 Troubleshooting

---

- 27 Troubleshooting
- 27 – General
- 28 – NOTES to use wireless
- 29 – NOTES to release Demo mode

## 5 Appendix

---

- 30 Trademarks and licenses
- 31 Specifications
- 32 Maintenance
- 32 – Handling the unit

1

2

3

4

5

## Unique features

### Auto power down

This unit supports to turn off by itself for saving energy consumption.

### Portable In

Listen to music from your portable device. (MP3 player, Notebook, Smart phone, etc..)

### LG Sound Sync

Controls volume level of this unit by the remote control of your LG TV that is compatible with LG Sound Sync.

### BLUETOOTH®

Listens to music stored on your **Bluetooth** device.

### USB playback

Listens to music stored on your USB device.

## Introduction

### Symbols used in this manual

#### Note

Indicates special notes and operating features.

#### Caution

Indicates cautions for preventing possible damages from abuse.

## Remote control

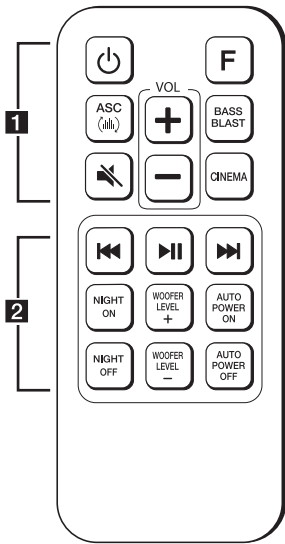

### Replacement of battery

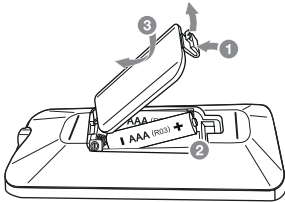

Remove the battery cover on the rear of the remote control, and insert battery with  $+$  and  $-$  matched correctly.

.....1.....

$\text{⏻}$  (Power) : Switches the unit ON or OFF

**F** : Selects the function and the input source.

**ASC** (🔊) : Analyzes the property of input sound and provides the sound optimized for the content in real time.

**BASS BLAST** : Selects reinforce the treble, bass and surround sound.

**CINEMA** : Selects cinematic surround sound.

**VOL +/—** : Adjusts speaker volume.

$\text{🔇}$  (Mute) : Mutes the sound.

.....2.....

$\text{⏮}/\text{⏭}$  (Skip/Search) :

- Skips Fast backward or Forward.

- Searches for a section within a file.

$\text{⏮}\text{||}\text{⏭}$  (Play/Pause) : Starts playback. / Pauses playback.

**NIGHT ON/OFF** :

- Turns on or off Night mode.

- Controls this unit using TV remote. (Refer to the page 19.)

**WOOFER LEVEL +/—** : Adjusts sound level of subwoofer.

**AUTO POWER ON/OFF** :

- Turns on or off AUTO POWER function. (Refer to the page 20.)

- Turns on or off the **Bluetooth** connection lock function. (Refer to the page 23.)

# Front panel

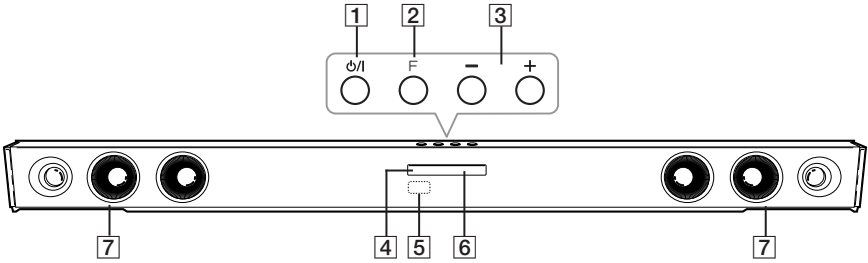

- 1** / (Standby/On)
- 2** **F** (Function)  
Selects the function and input source.
- 3** **- / +** (Volume)  
Adjusts volume level.
- 4** Standby LED  
It lights up in red on standby mode.
- 5** Remote sensor
- 6** Function LED
- 7** Speakers

# Rear panel

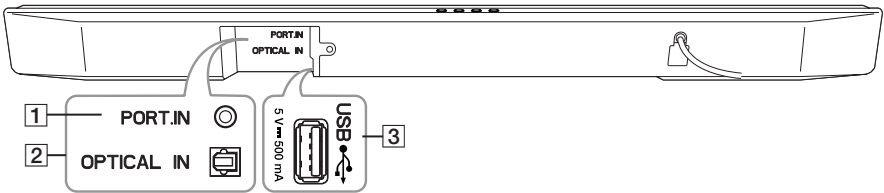

- 1** **PORT.IN** : Portable input
- 2** **OPTICAL IN** : Optical input
- 3** **USB**

## About LED condition

LED	Condition	Description
	OPTICAL LED turns on.	OPTICAL function is selected.
	OPTICAL LED blinks twice and turns on.	LG Sound Sync (Optical) function is selected.
	USB LED turns on.	USB function is selected.
	USB LED blinks.	Paused USB playback.
	<b>Bluetooth</b> LED turns on.	Paired with <b>Bluetooth</b> device.
	<b>Bluetooth</b> LED blinks.	Waiting for <b>Bluetooth</b> connection.
	USB and <b>Bluetooth</b> LEDs turn on.	PORTABLE function is selected.
	OPTICAL and USB LEDs turn on.	LG Sound Sync (Wireless) function is selected.

### ! Note

- When you press any button, standby LED (Red) on the main unit blinks.
- When you press (Mute) button, standby LED (Red) blinks slowly.
- When this unit reaches minimum volume, standby LED (Red) turns on for 2 seconds and blinks slowly.
- When this unit reaches maximum volume, standby LED (Red) turns on for 2 seconds.
- When you press volume (+/-) button continually, standby LED (Red) blinks quickly.

## Installing the sound bar

You can hear the sound by connecting the unit to the other device : TV, Blu-ray disc player, DVD player, etc.

Place the unit in front of the TV and connect it to the device you want. (Refer to pages 14 - 18)



### ⚠ Caution

- For best performance of wireless connection such as **Bluetooth** or wireless subwoofer, do not install the unit on Metallic furniture because wireless connection communicates through a module positioned on the bottom of the unit.
- Be careful not to make scratches on the surface of the Unit / Subwoofer when installing or moving them.

## Mounting the main unit on a wall

You can mount the main unit on a wall.



### ! Caution

Because it is difficult to make a connection after installing this unit, you should connect the cables before installation.

### Prepare screws and brackets.

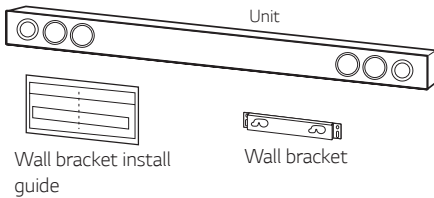

1. Match the TV's BOTTOM EDGE of Wall bracket install guide with the bottom of TV and attach to the position.

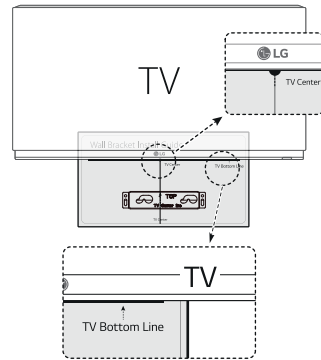

2. When you mount it on a wall (concrete), use the wall plugs (Not supplied). You should drill some holes. A guide sheet (Wall Bracket Install guide) is supplied to drill. Use the sheet to check the point to drill.

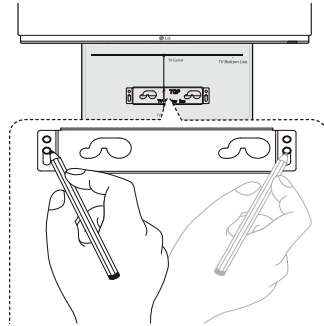

### ! Note

Screws and Wall Plugs are not supplied for mounting the unit. We recommend the Hilti (HUD-1 6 x 30) for the mounting.

3. Remove the Wall bracket install guide.

4. Fix it with screws (not supplied) as shown in the illustration below.

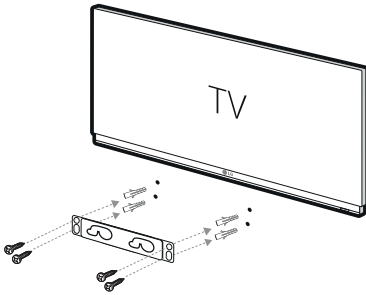

5. Hang the main unit onto the bracket as shown below.

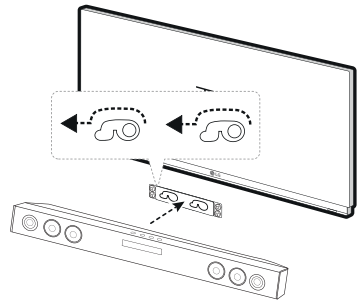

### ⚠ Caution

- Do not install this unit upside down. It can damage the parts of this unit or be the cause of personal injury.
- Do not hang onto the installed unit and avoid any impact to the unit.
- Secure the unit firmly to the wall so that it does not fall off. If the unit falls off, it may result in an injury or damage to the product.
- When the unit is installed on a wall, please make sure that a child does not pull any of connecting cables, as it may cause it to fall.

### ! Note

Detach the unit from the bracket as shown below.



# Wireless subwoofer connection

## LED indicator of wireless subwoofer

LED Color	Status
Green (Blink)	Attempting to make connection.
Green	The connection is completed.
Red	The wireless subwoofer is in standby mode or the connection is failed.
Off (No display)	The power cord of wireless subwoofer is disconnected.

## Setting up the wireless subwoofer for the first time

1. Connect the power cord to the subwoofer and plug the power cord into a power outlet.
2. Turn on the main unit : The sound bar and wireless subwoofer will be **automatically** connected.
  - Green LED on the rear of wireless subwoofer turns on.

## Manually pairing wireless subwoofer

When your connection is not completed, you can check red LED on the wireless subwoofer and the wireless subwoofer does not make sound. To solve the problem, follow the steps below.

1. Press **Pairing** button on the rear of the wireless subwoofer.

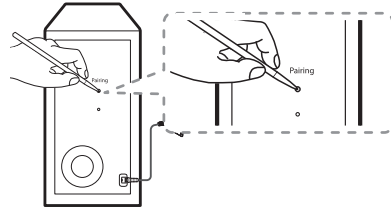

2. Turn on the main unit.
3. Pairing is completed.
  - The green LED on the rear of the wireless subwoofer turns on.

### ! Note

- It takes a few seconds (and may take longer) for the main unit and the subwoofer to communicate with each other and make sounds.
- The closer the main unit and the subwoofer, the better sound quality. It is recommended to install the main unit and the subwoofer as close as possible and avoid the cases below.
  - There is an obstacle between the main unit and the subwoofer.
  - There is a device using same frequency with this wireless connection such as a medical equipment, a microwave or a wireless LAN device.
  - Keep the sound bar and the subwoofer away from the device (ex. wireless router, microwave oven, etc.) over 1m to prevent wireless interference.

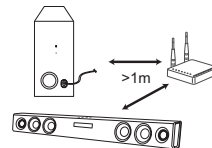

## Connecting to your TV

### Using an OPTICAL cable

1. Connect the OPTICAL IN jack on the back of the unit to OPTICAL OUT jack on the TV using an OPTICAL cable.

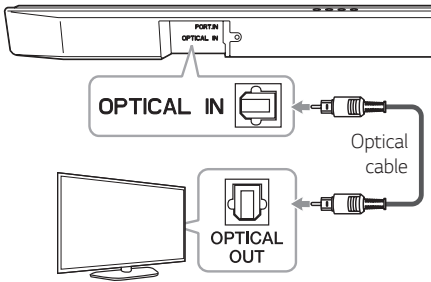

2. Select the input source to OPTICAL by pressing **F** button on the remote control or unit repeatedly.

#### ! Note

- Before connecting the optical cable, be sure to remove the protection plug cover if your cable has the cover.
- You can enjoy the TV audio through the speakers of this unit. In the case of some TV models, you must select the external speaker option from the TV menu. (For details, reference your TV user manual.)
- Set up the sound output of TV to listen to the sound through this unit :  
TV setting menu → [Sound] → [TV Sound output] → [External speaker (Optical)]
- Details of TV setting menu vary depending on the manufacturers or models of your TV.

## LG Sound Sync

Sound Sync  
Wireless

You can control some functions of this unit by your TV's remote control with LG Sound Sync. It is compatible with an LG TV that supports LG Sound Sync. Make sure of the LG Sound Sync logo on your TV.

Controllable function by LG TV's remote control :  
Volume up/down, Mute

Refer to the TV's instruction manual for the details of LG Sound Sync.

Make one of the following connections, depending on the capabilities of your equipment.

#### ! Note

- You can also use the remote control of this unit while using LG Sound Sync. If you use TV's remote control again, the unit synchronizes with the TV.
- When the connection fails, make sure of the condition of the TV and power.
- Make sure of the condition of this unit and the connection in the cases below when using LG Sound Sync.
  - The unit is turned off.
  - Changing to a different function.
  - Disconnecting the optical cable.
  - Disconnecting the wireless connection caused by interference or a distance.
- The amount of time to turn off this unit is different depending on your TV when you set AUTO POWER function to ON.
- Details of TV setting menu vary depending on the models of your TV.

## With wired connection

1. Connect your LG TV to the unit by using an optical cable.

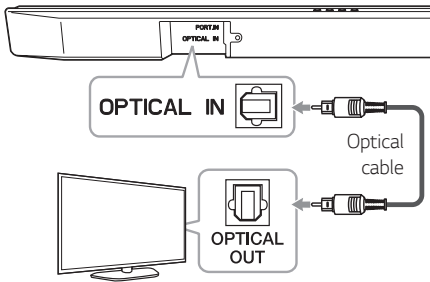

2. Set up the sound output of TV to listen to the sound through this unit :  
TV setting menu → [Sound] → [TV Sound output] → [LG Sound Sync (Optical)]
3. Turn on the unit by pressing on the remote control or on the unit.
4. Select the input source to OPTICAL by pressing **F** button on the remote control or unit repeatedly.

## With wireless connection

1. Turn on the unit by pressing on the remote control or on the unit.
2. Select the input source to LG TV by pressing **F** button on the remote control or unit repeatedly.
3. Set up the sound output of TV to listen to the sound through this unit :  
TV setting menu → [Sound] → [TV Sound output] → [LG Sound Sync (Wireless)]

### Note

If you turned off the unit directly by pressing on the remote control or on the unit, LG Sound Sync (Wireless) will be disconnected. To use this function again, you should reconnect the TV and the unit.

## Optional equipment connection

### OPTICAL IN connection

Connect an optical output jack of external devices to the OPTICAL IN jack.

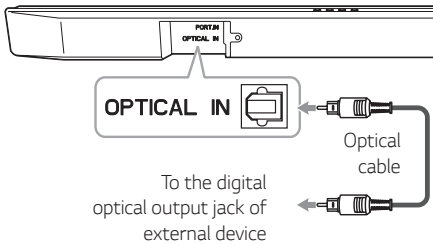

1. Connect the OPTICAL IN jack on the back of the unit to OPTICAL OUT jack of your external device.
2. Select the input source to OPTICAL by pressing **F** button on the remote control or unit repeatedly.
3. Listen to sound.

#### ! Note

Before connecting the optical cable, be sure to remove the protection plug cover if your cable has the cover.

### PORT. IN connection

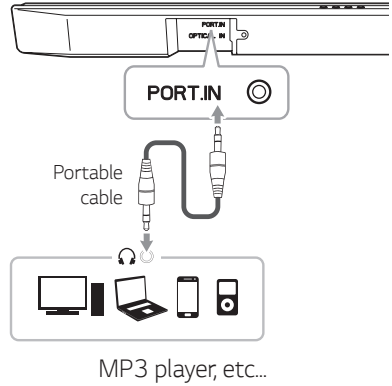

### Listening to music from your portable player

The unit can be used to play the music from many types of portable players or external devices.

1. Connect the portable player to the PORTABLE IN connector of the unit by using 3.5 mm stereo cable.
2. Select the input source to PORTABLE by pressing **F** button on the remote control or unit repeatedly.
3. Turn on the portable player or external device and start playing it.

## USB connection

Connect USB memory device to the USB port on the back of the unit.

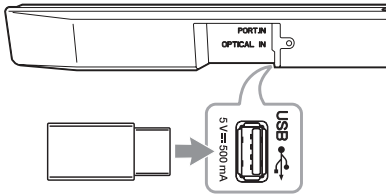

For more information of playing files on a USB, refer to the page 19.

Removing the USB Device from the unit.

1. Choose a different function/mode.
2. Remove the USB device from the unit.

## Compatible USB devices

- MP3 Player : Flash type MP3 player.
- USB Flash Drive : Devices that support USB 1.1.
- The USB function of this unit does not support some USB devices.

## USB device requirement

- Devices which require additional program installation connected to a computer, are not supported.
- Do not extract the USB device while in operation.
- For a large capacity USB, it may take longer than a few minutes to be searched.
- To prevent data loss, back up all data.
- This unit is not supported when the total number of files is 1000 or more.
- The unit's USB Port can not be connected to PC. The unit can not be used as a storage device.
- The exFAT file system is not supported on this unit. (FAT16/FAT32 systems are available.)
- Depending on some devices, it may not available to recognize the followings on this unit.
  - External HDD
  - Card readers
  - Locked devices
  - Hard type USB devices
  - USB hub
  - Using USB extension cable
  - iPhone/iPod/iPad
  - Android device

## Playable file

### Sampling Frequency

MP3 : within 32 to 48 kHz

WMA : within 32 to 48 kHz

### Bitrate

MP3 : within 80 to 320 kbps

WMA : within 56 to 128 kbps

- Maximum files : Under 999
- Maximum directories : Under 99
- A protected file by DRM (Digital rights management) cannot be played on the unit.
- Video files in the USB storage device can not be played.
- Depending on the performance of your USB device, playback may not work well.

### ! Note

- Folders and files on the USB are recognized as below.

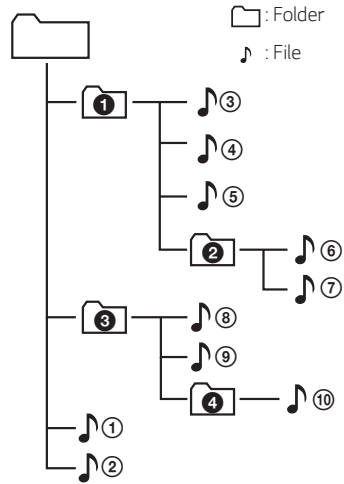

- File will be played from file ① to file ⑩ one by one.
- Files will be played in order recorded and it may be different depending on the record circumstances.
- You can't see a folder or file through this unit.

## Basic operations

### USB operation

1. Connect the USB device to the USB port.
2. Select the input source to USB by pressing **F** button on the remote control or unit repeatedly.

To	Do this
Playback	Press <b>▶  </b> .
Pause	During playback, press <b>▶  </b> .
Skip to the next/ previous file	During playback, press <b>▶▶</b> on the remote control to go to the next file. Playing less than 2 seconds, press <b>◀◀</b> on the remote control to go to the previous file. Playing after 3 seconds, press <b>◀◀</b> on the remote control to go to the beginning of the file.
Search for a section within a file	Press and hold <b>◀◀/▶▶</b> during playback and release it at the point you want to listen to.
Resume playback	This unit memorizes a current song which is played before changing the function or turning off the unit.

#### ! Note

- The resume point may be cleared when you pull out the power cord or removing the USB device from the unit.
- If the USB function is not working, check the USB function is selected.
- When you pause the USB playback, USB LED on the main unit blinks.

## Other operations

### Turn off the sound temporarily

Press **🔇**(Mute) to mute your unit. To cancel it, press **🔇**(Mute) again on the remote control or change the volume level.

### Using your TV remote control

You can control some functions of this unit by your TV remote control even by other company's product. Controllable functions are volume up/down and mute.

Press and hold **NIGHT ON** on the remote control for about 2 seconds.

To turn off this function, press and hold **NIGHT OFF** about 2 seconds.

#### ! Note

- Supported TV brands

LG	Panasonic	Philips	Samsung
Sharp	Sony	Toshiba	Vizio

- Make sure that the sound output of your TV is set to [External speaker].
- Depending on the remote control, this function may not work well.
- This function does not operate on LG TV's magic remote control.

## Auto power down

This unit will turn itself off to save electric consumption if the main unit is not connected to an external device and has not been used for 15 minutes.

This unit also turns off after six hours if the Main unit has been connected to another device using the analog input. (Ex : Portable, etc..)

## AUTO POWER On/Off

This unit automatically turns on by an input source : Optical, LG TV or **Bluetooth**.

When you turn on your TV or an external device connected to this unit, this unit recognizes the input signal and select the suitable function. You can hear the sound from your device.

If you try to connect your **Bluetooth** device, this unit turns on and the unit will be connected your **Bluetooth** device.

This function turns on or off you press **AUTO POWER ON/OFF**.

### ! Note

- After the unit is turned on by AUTO POWER function, it will be automatically turned off if there is no signal for a certain period of time from the external device.
- If you turned off the unit directly, it cannot be turned on automatically by AUTO POWER function. However the unit can be turned on by AUTO POWER function when optical signal comes in after 5 seconds of no signal.
- Depending on the connected device, this function may not operate.
- If you disconnect **Bluetooth** connection by this unit, some **Bluetooth** devices try to connect to the unit continually. Therefore it is recommended to disconnect the connection before turn off the unit.
- When you turn on this unit for the first time, Auto Power function is turned on status.
- To use this function, the main unit must be registered in paired devices list of **Bluetooth** device.
- You can set the AUTO POWER function only when this unit is turned on.

## Auto function change

This unit recognizes input signals such as Optical, **Bluetooth**, LG TV and Portable and then changes suitable function automatically.

### When optical signal comes in

When you turn on the external device connected to this unit by an optical cable, this unit change the function to optical. You can hear the sound from your device.

### When you try to connect Bluetooth device

When you try to connect your **Bluetooth** device to this unit, **Bluetooth** function is selected. Play your music on the **Bluetooth** device.

### When LG TV signal comes in

When you turn on your LG TV connected by LG Sound Sync (Wireless connection), this unit changes the function to LG TV. You can hear the sound from your TV.

### When connect a Portable device

When you connect your portable device using a portable cable, this unit changes the function to Portable. You can hear the music from your device.

#### Note

- To change to optical function, it needs 5 seconds of no signal.
- If the **Bluetooth** connection lock function is set, **Bluetooth** connection will be only available on **Bluetooth** and LG TV function. (Refer to the 23 page.)

## Using BLUETOOTH® technology

### About Bluetooth

**Bluetooth** is wireless communication technology for short range connection.

The sound may be interrupted when the connection interfered by the other electronic wave or you connect the **Bluetooth** in the other rooms.

Connecting individual devices under **Bluetooth** wireless technology does not incur any charges.

A mobile phone with **Bluetooth** wireless technology can be operated via the Cascade if the connection was made via **Bluetooth** wireless technology.

- Available Devices : Smart phone, MP3 player, Notebook, etc..
- Version : 4.0
- Codec : SBC

### Bluetooth Profiles

In order to use **Bluetooth** wireless technology, devices must be able to interpret certain profiles. This unit is compatible with following profile.

A2DP (Advanced Audio Distribution Profile)

## Listening to music stored on the Bluetooth devices

### Pairing your unit and Bluetooth device

Before you start the pairing procedure, make sure the **Bluetooth** feature is turned on in to your **Bluetooth** device. Refer to your **Bluetooth** device's user guide. Once a pairing operation is performed, it does not need to be performed again.

1. Select the input source to **Bluetooth** by pressing **F** button on the remote control or unit repeatedly.
  - **Bluetooth** LED will blink.
2. Operate the **Bluetooth** device and perform the pairing operation. When searching for this unit with the **Bluetooth** device, a list of the devices found may appear in the **Bluetooth** device display depending on the type of **Bluetooth** device. Your unit appears as "LG SJ3 (XX)".

#### ! Note

- XX means the last two digits of **Bluetooth** address. For example, if your unit has a **Bluetooth** address such as 9C:02:98:4A:F7:08, you will see "LG SJ3 (08)" on your **Bluetooth** device.
- Depending on the **Bluetooth** device type, some device have a different pairing way. Enter the PIN code (0000) as needed.

3. When this unit is successfully connected with your **Bluetooth** device, **Bluetooth** LED will turn on.
4. Listen to music.
 

To play a music stored on your **Bluetooth** device, refer to your **Bluetooth** device's user guide.

### ! Note

- When using **Bluetooth** technology, you have to make a connection between the unit and the **Bluetooth** device as close as possible and keep the distance.  
However it may not work well in the cases below :
  - There is an obstacle between the unit and the **Bluetooth** device.
  - There is a device using same frequency with **Bluetooth** technology such as a medical equipment, a microwave or a wireless LAN device.
- You should connect your **Bluetooth** device to this unit again when you restart it.
- The sound may be interrupted when the connection is interfered by the other electronic wave.
- You may not control the **Bluetooth** device with this unit.
- Pairing is limited to one **Bluetooth** device per one unit and multi-pairing is not supported.
- Depending on the type of the device, you may not be able to use the **Bluetooth** function.
- You can enjoy **Bluetooth** function using Smart phone, MP3 player, Notebook, etc..
- The more distance between the unit and the **Bluetooth** device, the lower the sound quality becomes.
- **Bluetooth** connection will be disconnected when the unit is turned off or the **Bluetooth** device gets far from the unit.
- When **Bluetooth** connection is disconnected, connect the **Bluetooth** device to the unit again.
- When the unit is not connected with **Bluetooth** device, **Bluetooth** LED will blink.
- When you connect a **Bluetooth** device (iOS device etc.) to this unit or operate the device, the volume level can be synchronized between the two devices.
- You can control a **Bluetooth** device using **⏮/⏭** (Skip) and **⏸** (Play/Pause) buttons on the remote control.

### BLUETOOTH connection lock (BT lock)

You can limit **Bluetooth** connection to only **Bluetooth** and LG TV function to prevent unintended **Bluetooth** connection.

Press and hold **AUTO POWER ON** on the remote control for about 2 seconds to turn on this function in Bluetooth function.

To turn off this function, press and hold **AUTO POWER OFF** on the remote control for about 2 seconds in Bluetooth function.

### ! Note

Even if you set up **Bluetooth** connection lock to On, this sound bar turns on by Auto Power function.

## Using BLUETOOTH App

### ! Note

- Only Android OS is available to use “Music Flow Bluetooth” app with this unit.
- Additional data charges may occur if installed over 3G/4G, according to your device plan.

### About “Music Flow Bluetooth” App

“Music Flow Bluetooth” app brings a suite of new features to this unit.

To enjoy more features, you are recommended to download and install free “Music Flow Bluetooth” app.

### Install “Music Flow Bluetooth” App onto Your BLUETOOTH Device

There are two ways to install “Music Flow Bluetooth” app onto your **Bluetooth** device.

#### Install “Music Flow Bluetooth” App through QR code

1. Install “Music Flow Bluetooth” app through QR code. Use the scanning software to scan the QR code.



2. Tap an icon for installation.

### ! Note

- Make sure that your **Bluetooth** device is connected to the Internet.
- Make sure that your **Bluetooth** device has a scanning software application. If you don't have one, download one from “Google Android Market (Google Play Store)”.
- Depending on the area, QR code may not work.

### Install “Music Flow Bluetooth” App through “Google Android Market (Google Play Store)”

1. Tap the “Google Android Market (Google Play Store)” icon.
2. In the search bar, type in the “Music Flow Bluetooth” and search it.
3. In the search result list, find and tap “Music Flow Bluetooth” to start downloading **Bluetooth** app.
4. Tap an icon for installation.
5. Tap an icon for downloading.

### ! Note

- Make sure that your **Bluetooth** device is connected to the Internet.
- Make sure that your **Bluetooth** device is equipped with “Google Android Market (Google Play Store)”.

### Activate Bluetooth with “Music Flow Bluetooth” App

“Music Flow Bluetooth” app helps to connect your **Bluetooth** device to this unit.

1. Tap “Music Flow Bluetooth” app icon on the home screen to open “Music Flow Bluetooth” app, and go to the main menu.
2. If you want to get more information to operate, tap [Setting] and tap [Help] menu.

 **Note**

- “Music Flow Bluetooth” app will be available in the software version as follow;
  - Android O/S : Ver 4.0.3 (or later)
- If you use “Music Flow Bluetooth” app for operation, there would be some differences between “Music Flow Bluetooth” app and the supplied remote control. Use the supplied remote control as necessary.
- Depending on the **Bluetooth** device, “Music Flow Bluetooth” app may not work.
- After connection of “Music Flow Bluetooth” app, music may be output from your device. In this case, try connecting procedure again.
- If you operate the other applications or change the settings on your **Bluetooth** device while using “Music Flow Bluetooth” app, “Music Flow Bluetooth” app may operate abnormally.
- When “Music Flow Bluetooth” app operates abnormally, check your **Bluetooth** device and the connection of “Music Flow Bluetooth” app and then try to connect again.
- Depending on the smart phone's operating system, you have some differences for “Music Flow Bluetooth” operation.
- Even though **Bluetooth** connection will be disconnected, you can use “Music Flow Bluetooth” app when you change the function.
- Additional features offered by “Music Flow Bluetooth” app may not work depending on distance the between this unit and **Bluetooth** device and wireless conditions.

## Sound adjustment

### Setting the surround mode

This system has a number of pre-set surround sound fields. You can select a desired sound mode by using each sound mode button.

Sound effect	Description
ASC (Adaptive Sound Control)	Analyzes the property of input sound and provides the sound optimized for the content in real time.
BASS BLAST	Reinforces the treble, bass and surround sound effect.
CINEMA	You can enjoy more immersive and cinematic surround sound.

#### ! Note

- In some of sound effect mode, some speakers, there's no sound or low sound. It depends on the mode of sound and the source of audio, it is not defective.
- You may need to reset the sound effect mode, after switching the input, sometimes even after the sound file changed.

### Adjust the woofer level settings

You can adjust the sound level of woofer by pressing **WOOFER LEVEL +/—** button.

#### ! Note

When the subwoofer level reaches maximum or minimum, standby LED (Red) on the main unit turns on for 2 seconds.

### Night mode

This function is useful when you want to watch movies at low volume late at night. Set Night mode to On to reduce the sound intensity and improve fineness and softness.

Press **NIGHT ON/OFF** button to turn on or off night mode.

# Troubleshooting

## General

PROBLEM	CAUSE & CORRECTION
The unit does not work properly.	<ul style="list-style-type: none"> <li>• Turn off the power of this unit and the connected external device (TV, Woofer, DVD-player, Amplifier, etc.) and turn them on again.</li> <li>• Disconnect the power cord of this unit and the connected external device (TV, Woofer, DVD-player, Amplifier, etc.) and then try connecting again.</li> <li>• Previous setting may not be saved when device power is shut off.</li> </ul>
No Power	<ul style="list-style-type: none"> <li>• The power cord is unplugged. Plug in the power cord.</li> <li>• Check whether electricity failed. Check the condition by operating other electronic devices.</li> </ul>
No sound	<ul style="list-style-type: none"> <li>• Incorrect input source is selected. Check the input source and select the correct input source.</li> <li>• The mute function is activated. Press  (Mute) or adjust the volume level to cancel the mute function.</li> <li>• When you are using connection with an external device (set top box, <b>Bluetooth</b> device etc.), adjust volume level of the device.</li> </ul>
No woofer sound	<ul style="list-style-type: none"> <li>• The power cord of woofer is not connected. Plug the power cord into the wall outlet securely.</li> <li>• Pairing between the unit and woofer gets disconnected. Connect the unit and woofer. (Refer to the page 13.)</li> </ul>
The remote control does not work properly.	<ul style="list-style-type: none"> <li>• The remote control is too far from the unit. Operate the remote control within about 7 m.</li> <li>• There is an obstacle in the path of the remote control and the unit. Remove the obstacle.</li> <li>• The batteries in the remote control is exhausted. Replace the batteries with new one.</li> </ul>
The AUTO POWER function does not work.	<ul style="list-style-type: none"> <li>• Check connection of the external device such as TV, DVD/Blu-Ray player or <b>Bluetooth</b> device.</li> <li>• Depending on the connected device, this function may not operate.</li> </ul>
LG Sound Sync does not work.	<ul style="list-style-type: none"> <li>• Check whether your LG TV supports LG Sound Sync.</li> <li>• Check connection of LG Sound Sync (Optical or wireless).</li> <li>• Check sound setting of your TV and this unit.</li> </ul>
The unit does not connect with <b>Bluetooth</b> device	<ul style="list-style-type: none"> <li>• Turn off the <b>Bluetooth</b> connection lock function. (Refer to the page 23.)</li> </ul>

PROBLEM	CAUSE & CORRECTION
<p>When you feel the output sound of the unit is low.</p>	<p>Check the details below and adjust the unit according to them.</p> <ul style="list-style-type: none"> <li>• Change Audio DRC setting on connected device setup menu to [OFF] state.</li> <li>• With the sound bar connected with TV, change the AUDIO DIGITAL OUT setting on TV Setup Menu from [PCM] to [AUTO] or [BITSTREAM].</li> <li>• With the sound bar connected with Player, change the AUDIO DIGITAL OUT setting on Player Setup Menu from [PCM] to [PRIMARY PASS-THROUGH] or [BITSTREAM].</li> <li>• Make sure Night Mode is not On. Turn [OFF] Night Mode.</li> </ul>

## NOTES to use wireless

PROBLEM	CAUSE & CORRECTION
<p>This device may have wireless interference.</p>	<ul style="list-style-type: none"> <li>• Wireless may not operate normally in weak signal area.</li> <li>• Please install the device close enough to wireless subwoofer.</li> <li>• Do not install the device on metal furniture for optimum performance.</li> </ul>
<p><b>Bluetooth</b> device may malfunction or make noise in the following cases.</p>	<ul style="list-style-type: none"> <li>• When any part of your body contact the transceiver of the <b>Bluetooth</b> device or sound bar.</li> <li>• When there is an obstacle or wall or the device is installed in a secluded spot.</li> <li>• When there is a device(a wireless LAN, a medical equipment or a microwave) using same frequency, make the distance between the products as far away as possible each other.</li> <li>• When to connecting the device to the <b>Bluetooth</b> device, make the distance between the products as close as possible each other.</li> <li>• When the device gets too far from the <b>Bluetooth</b> device, the connection is disconnected and also malfunction may occur.</li> </ul>

## NOTES to release Demo mode

PROBLEM	CAUSE & CORRECTION
Can not change input source with F button such as BT (Bluetooth) etc. and All the function LEDs are turned on.	<ul style="list-style-type: none"> <li>• Unplug the power cord and plug it in again. If that doesn't work, press and hold F button (About 15 seconds) on the main unit until the function LED indicates current selected function.</li> </ul>
Remote Control does not work. (No response)	

## Trademarks and licenses

All other trademarks are trademarks of their respective owners.

---



Manufactured under license from Dolby Laboratories. Dolby, Dolby Audio, and the double-D symbol are trademarks of Dolby Laboratories.

---



For DTS patents, see <http://patents.dts.com>. Manufactured under license from DTS Licensing Limited. DTS, the Symbol, & DTS and the Symbol together are registered trademarks, and DTS Digital Surround is a trademark of DTS, Inc. © DTS, Inc. All Rights Reserved.

---



The **Bluetooth** word mark and logos are owned by the Bluetooth SIG, Inc. and any use of such marks by LG Electronics is under license.

Other trademarks and trade names are those of their respective owners.

---

# Specifications

General	
Power requirements	Refer to main label.
Power consumption	Refer to main label.
Dimensions (W x H x D)	Approx. 950 mm x 71 mm x 47 mm
Operating temperature	5 °C to 35 °C
Operating humidity	5 % to 90 %
Bus Power Supply	5 V  500 mA
Available Digital Input Audio Sampling Frequency	32 kHz, 44.1 kHz, 48 kHz, 88.2 kHz, 96 kHz
Available Digital Input Audio format	Dolby Audio, DTS Digital Surround, PCM

Inputs	
OPTICAL IN (Digital audio in)	3 V (p-p), Optical jack x 1
PORT. IN (Portable in)	0.32 Vrms (3.5 mm stereo jack) x 1

Amplifier (RMS Output power)	
Total	300 W RMS
Front	50 W RMS x 2 (4 $\Omega$ at 1 kHz, 10% THD)
Subwoofer	200 W RMS (3 $\Omega$ at 80 Hz, 10% THD)

Wireless subwoofer	
Power requirements	Refer to main label on the subwoofer.
Power consumption	Refer to main label on the subwoofer.
Type	1 Way 1 Speaker
Impedance	3 $\Omega$
Rated Input Power	200 W RMS
Max. Input Power	400 W RMS
Dimensions (W x H x D)	Approx. 171 mm x 320 mm x 252mm

- Designs and specifications are subject to change without prior notice.

# Maintenance

## Handling the unit

### When shipping the unit

Please save the original shipping carton and packing materials. If you need to ship the unit, for maximum protection, re-pack the unit as it was originally packed at the factory.

### Keeping the exterior surfaces clean

- Do not use volatile liquids such as insecticide spray near the unit.
- Wiping with strong pressure may damage the surface.
- Do not leave rubber or plastic products in contact with the unit for a long period of time.

### Cleaning the unit

To clean the player, use a soft, dry cloth. If the surfaces are extremely dirty, use a soft cloth lightly moistened with a mild detergent solution. Do not use strong solvents such as alcohol, benzine, or thinner, as these might damage the surface of the unit.

