



ENGLISH

ESPAÑOL

PORTUGUÊS

OWNER'S MANUAL

AIR CONDITIONER

Please read this manual carefully before operating your set and retain it for future reference.

CEILING CONCEALED DUCT



MFL67902906
Rev.00_041619

www.lg.com

Copyright © 2014 - 2019 LG Electronics Inc. All Rights Reserved.

TIPS FOR SAVING ENERGY

Here are some tips that will help you minimize the power consumption when you use the air conditioner. You can use your air conditioner more efficiently by referring to the instructions below:

- Do not cool excessively indoors. This may be harmful for your health and may consume more electricity.
- Block sunlight with blinds or curtains while you are operating the air conditioner.
- Keep doors or windows closed tightly while you are operating the air conditioner.
- Adjust the direction of the air flow vertically or horizontally to circulate indoor air.
- Speed up the fan to cool or warm indoor air quickly, in a short period of time.
- Open windows regularly for ventilation as the indoor air quality may deteriorate if the air conditioner is used for many hours.
- Clean the air filter once every 2 weeks. Dust and impurities collected in the air filter may block the air flow or weaken the cooling / dehumidifying functions.

For your records

Staple your receipt to this page in case you need it to prove the date of purchase or for warranty purposes. Write the model number and the serial number here:

Model number : _____

Serial number : _____

You can find them on a label on the side of each unit.

Dealer's name : _____

Date of purchase : _____

IMPORTANT SAFETY INSTRUCTIONS

READ ALL INSTRUCTIONS BEFORE USING THE APPLIANCE.

Always comply with the following precautions to avoid dangerous situations and ensure peak performance of your product

! WARNING

It can result in serious injury or death when the directions are ignored

! CAUTION

It can result in minor injury or product damage when the directions are ignored

! WARNING

- Installation or repairs made by unqualified persons can result in hazards to you and others.
- The product shall be installed according to the Wiring regulations of the corresponding country.
- The information contained in the manual is intended for use by a qualified service technician familiar with safety procedures and equipped with the proper tools and test instruments.
- Failure to carefully read and follow all instructions in this manual can result in equipment malfunction, property damage, personal injury and/or death.

Installation

- Do not use a defective or underrated circuit breaker. Use this appliance on a dedicated circuit. There is risk of fire or electric shock.
- For electrical work, contact the dealer, seller, a qualified electrician, or an Authorized Service Center. Do not disassemble or repair the product. There is risk of fire or electric shock.
- Always ground the product. There is risk of fire or electric shock.
- Install the panel and the cover of control box securely. There is risk of fire or electric shock.
- Always install a dedicated circuit and breaker. Improper wiring or installation may cause fire or electric shock
- Use the correctly rated breaker or fuse. There is risk of fire or electric shock.
- Do not modify or extend the power cable. There is risk of fire or electric shock.
- Do not install, remove, or re-install the unit by yourself (customer). There is risk of fire, electric shock, explosion, or injury.
- Be cautious when unpacking and installing the product. Sharp edges could cause injury. Be especially careful of the case edges and the fins on the condenser and evaporator.
- For installation, always contact the dealer or an Authorized Service Center. There is risk of fire, electric shock, explosion, or injury.
- Do not install the product on a defective installation stand. It may cause injury, accident, or damage to the product.
- Be sure the installation area does not deteriorate with age. If the base collapses, the air conditioner could fall with it, causing property damage, product failure, and personal injury.
- Do not let the air conditioner run for a long time when the humidity is very high and a door or a window is left open. Moisture may condense and wet or damage furniture.

Operation

- Take care to ensure that power cable could not be pulled out or damaged during operation. There is risk of fire or electric shock.
- Do not place anything on the power cable. There is risk of fire or electric shock.
- Do not plug or unplug the power supply plug during operation. There is risk of fire or electric shock.
- Do not touch(operate) the product with wet hands. There is risk of fire or electrical shock.
- Do not place a heater or other appliances near the power cable. There is risk of fire and electric shock.
- Do not allow water to run into electric parts. It may cause There is risk of fire, failure of the product, or electric shock.
- Do not store or use flammable gas or combustibles near the product. There is risk of fire or failure of product.
- Do not use the product in a tightly closed space for a long time. Oxygen deficiency could occur.
- When flammable gas leaks, turn off the gas and open a window for ventilation before turn the product on. Do not use the telephone or turn switches on or off. There is risk of explosion or fire
- If strange sounds, or small or smoke comes from product. Turn the breaker off or disconnect the power supply cable. There is risk of electric shock or fire.
- Stop operation and close the window in storm or hurricane. If possible, remove the product from the window before the hurricane arrives. There is risk of property damage, failure of product, or electric shock.
- Do not open the inlet grill of the product during operation.(Do not touch the electrostatic filter, if the unit is so equipped.) There is risk of physical injury, electric shock, or product failure.
- When the product is soaked (flooded or submerged), contact an Authorized Service Center. There is risk of fire or electric shock.
- Be cautious that water could not enter the product. There is risk of fire, electric shock, or product damage.
- Ventilate the product from time to time when operating it together with a stove, etc. There is risk of fire or electric shock.
- Turn the main power off when cleaning or maintaining the product. There is risk of electric shock.
- When the product is not be used for a long time, disconnect the power supply plug or turn off the breaker. There is risk of product damage or failure, or unintended operation.
- Take care to ensure that nobody could step on or fall onto the outdoor unit. This could result in personal injury and product damage.

CAUTION

Installation

- Always check for gas (refrigerant) leakage after installation or repair of product. Low refrigerant levels may cause failure of product.
- Install the drain hose to ensure that water is drained away properly. A bad connection may cause water leakage.
- Keep level even when installing the product. To avoid vibration or water leakage.
- Do not install the product where the noise or hot air from the outdoor unit could damage the neighborhoods. It may cause a problem for your neighbors.
- Use two or more people to lift and transport the product. Avoid personal injury.
- Do not install the product where it will be exposed to sea wind (salt spray) directly. It may cause corrosion on the product. Corrosion, particularly on the condenser and evaporator fins, could cause product malfunction or inefficient operation.

Operation

- Do not expose the skin directly to cool air for long periods of time. (Don't sit in the draft.) This could harm to your health.
- Do not use the product for special purposes, such as preserving foods, works of art, etc. It is a consumer air conditioner, not a precision refrigeration system. There is risk of damage or loss of property.
- Do not block the inlet or outlet of air flow. It may cause product failure.
- Use a soft cloth to clean. Do not use harsh detergents, solvents, etc. There is risk of fire, electric shock, or damage to the plastic parts of the product.
- Do not touch the metal parts of the product when removing the air filter. They are very sharp! There is risk of personal injury.
- Do not step on or put anything on the product. (outdoor units) There is risk of personal injury and failure of product.
- Always insert the filter securely. Clean the filter every two weeks or more often if necessary. A dirty filter reduces the efficiency of the air conditioner and could cause product malfunction or damage.
- Do not insert hands or other objects through the air inlet or outlet while the product is operated. There are sharp and moving parts that could cause personal injury.
- Do not drink the water drained from the product. It is not sanitary and could cause serious health issues.
- Use a firm stool or ladder when cleaning or maintaining the product. Be careful and avoid personal injury.
- Replace the all batteries in the remote control with new ones of the same type. Do not mix old and new batteries or different types of batteries. There is risk of fire or explosion
- Do not recharge or disassemble the batteries. Do not dispose of batteries in a fire. They may burn or explode.
- If the liquid from the batteries gets onto your skin or clothes, wash it well with clean water. Do not use the remote if the batteries have leaked. The chemicals in batteries could cause burns or other health hazards.
- If you eat the liquid from the batteries, brush your teeth and see doctor. Do not use the remote if the batteries have leaked. The chemicals in batteries could cause burns or other health hazards.

TABLE OF CONTENTS

2 TIPS FOR SAVING ENERGY

3 IMPORTANT SAFETY INSTRUCTIONS

7 BEFORE USE

7 Preparing for operation

7 Usage

7 Cleaning and maintenance

7 Service

8 PRODUCT INTRODUCTION

8 Name and function of parts

9 Wired Remote Controller

10 Wireless Remote Controller
(Accessory)

11 OPERATING INSTRUCTIONS

11 Standard Operation - Standard Cooling

12 Standard Operation - Dehumidification Mode

13 Standard Operation - Auto Operation Mode

14 Standard Operation - Fan Mode

15 Function Setting - Fan Speed Selection

16 Standard Operation - Temperature Setting/Room Temperature Check

17 Function setting - Child Lock

18 MAINTENANCE AND SERVICE

19 When the air conditioner is not going to be used for a long time.

19 Operation Tips!

20 Troubleshooting Tips! Save time and money!

BEFORE USE

Preparing for operation

- Contact an installation specialist for installation.
- Use a dedicated circuit.

Usage

- Being exposed to direct airflow for an extended period of time could be hazardous to your health. Do not expose occupants, pets, or plants to direct airflow for extended periods of time.
- Due to the possibility of oxygen deficiency, ventilate the room when used together with stoves or other heating devices.
- Do not use this air conditioner for non-specified special purposes (e.g. preserving precision devices, food, pets, plants, and art objects). Such usage could damage the items.

Cleaning and maintenance

- Do not touch the metal parts of the unit when removing the filter. Injuries can occur when handling sharp metal edges.
- Do not use water to clean inside the air conditioner. Exposure to water can destroy the insulation, leading to possible electric shock.
- When cleaning the unit, first make sure that the power and breaker are turned off. The fan rotates at a very high speed during operation. There is a possibility of injury if the unit's power is accidentally triggered on while cleaning inner parts of the unit.

Service

For repair and maintenance, contact your authorized service dealer.

PRODUCT INTRODUCTION

Name and function of parts

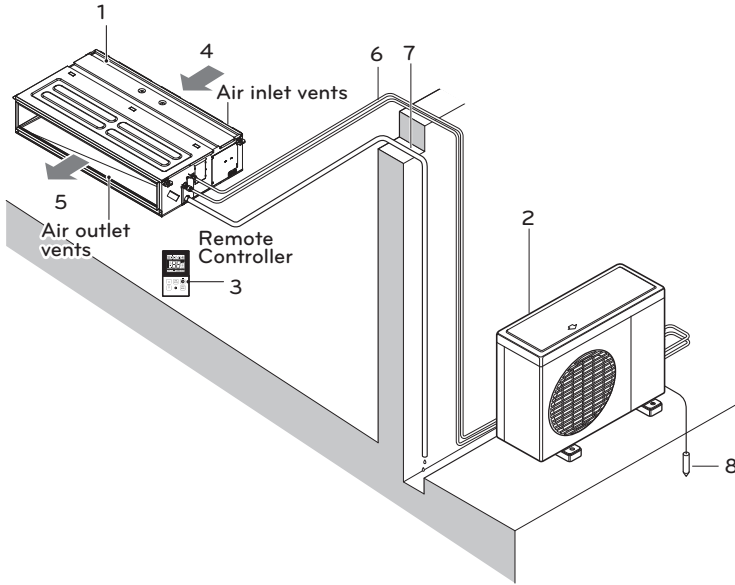

- 1 Indoor unit
- 2 Outdoor unit
- 3 Remote controller
- 4 Inlet air
- 5 Discharge air
- 6 Refrigerant piping, connection electric wire
- 7 Drain pipe
- 8 Ground wire
wire to ground outdoor unit to prevent electrical shocks.

Wired Remote Controller

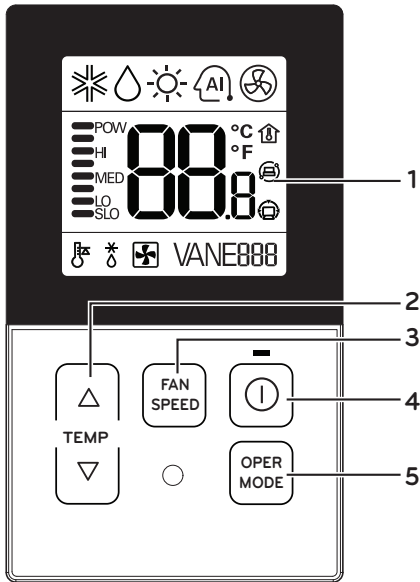

- 1 Operation Display Panel
- 2 Temperature Control Button
- 3 Fan Speed Button
- 4 On/Off Button
- 5 Operation Mode select Button

* Some functions may not be operated and displayed depending on the product type.

! NOTE

- Display temperature can be different from actual room temperature if the remote controller is installed at the place where sun-rays are falling directly or the place nearby heat source.
- The actual product can be different from above contents depending upon model type.
- When using simultaneous operation system, whenever press remote controller button, system will approximately operate after 1~2 minutes.

Wireless Remote Controller (Accessory)

This air-conditioner is equipped with wired remote controller basically. But if you want to be available with wireless remote controller, you pay for it.

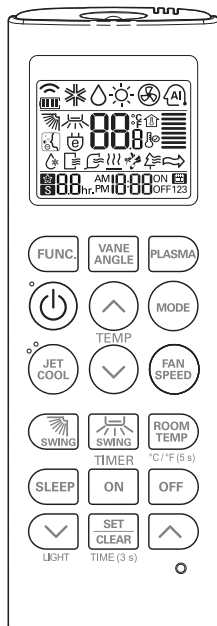

PQWRCQ0FDB

! CAUTION

- Aim at the signal receiver on the wired remote controller so as to operate.
- The remote control signal can be received at a distance of up to about 7 m.
- Be sure that there are no obstructions between the remote controller and the signal receptor.
- Do not drop or throw the remote controller.
- Do not place the remote controller in a location exposed to direct sunlight, or near the heating unit, or any other heat source.
- Block a strong light over the signal receptor with a curtain or etc. so as to prevent the abnormal operation. (ex : electronic quick start, ELBA, inverter type fluorescent lamp)

! NOTE

- For more details refer to the Wireless Remote Control Accessory manual.
- The actual product can be different from above contents depending upon model type.
- The wireless remote controller does not operate When using simultaneous operation system.

OPERATING INSTRUCTIONS

Standard Operation - Standard Cooling

It cools the room by comfortable and clean wind.

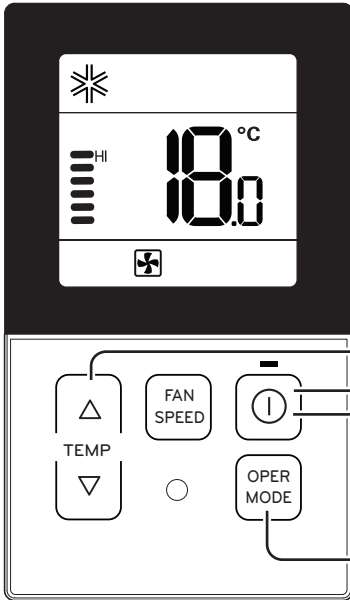

1 Cooling operation will begin if you press the  button.

2 Press the temperature button and set the desired room temperature lower than the current room temperature.



— A click of the button will increase the desired temperature by 1 °C or 2 °F.

— A click of the button will decrease the desired temperature by 1 °C or 2 °F.

- Setting temp range : 18 °C~30 °C (64 °F~86 °F)

- If the desired temperature is set higher than the current room temperature, the cooling function will not begin and just the blowing operation will continue.



3 If you Press the mode button during the operation, the operation mode will be changed in the order of cooling, dry(dehumidification),heating,auto-operation and fan operation. If the product is a cooling-only model, the operation mode will be changed in the order of cooling, dry(dehumidification), auto-operation and fan operation.

4 If you press the  button, the cooling operation will stop.

Standard Operation - Dehumidification Mode

It removes humidity while air-cooling weakly.



The diagram shows the control panel of an air conditioner. The display screen is divided into three sections: the top section shows a water drop icon, the middle section shows 'dh' in large characters, and the bottom section shows 'LO' and a fan icon. Below the display are four buttons: 'TEMP' with up and down arrows, 'FAN SPEED' with a fan icon, 'OPER MODE' with a power button icon, and a small circular button. Lines connect the 'FAN SPEED' and 'OPER MODE' buttons to step 3, and the 'OPER MODE' button to step 1.

- 1 After operating the product by pressing the  button, set up the dry (Dehumidification) by pressing the  button.
- 2 When the dry operation is selected, "dh" will be shown on the display window as shown on the left side.
 - The temperature setting can not be adjusted during operation this mode.
- 3 Press the  button to select airflow rate [LO→MED→HI].
 - The initial wind powerfulness of humidity removal drive is 'weak'.



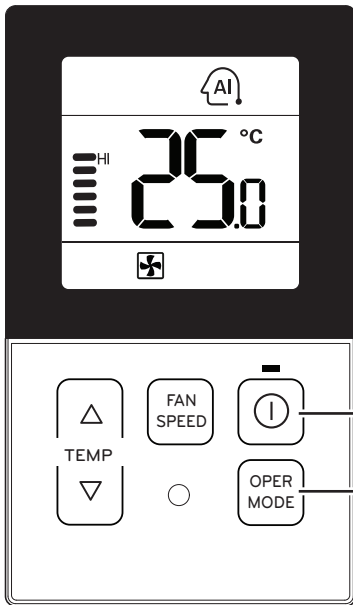

- In rainy season or high humidity climate, it is possible to operate simultaneously dehumidifier and cooling mode to remove humidity effectively.
- The menu item of wind powerfulness might not be partially selected according to the product.

Standard Operation - Auto Operation Mode

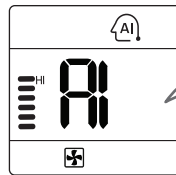

- 1 After operating the product by pressing the  button, set up the auto operation by pressing the  button.
- 2 When desired the set temperature is lower than the room temperature during the auto operation => Cooling operation
- Setting temp range : 18 °C~30 °C (64 °F~86 °F)
- 3 "Auto Operation Mode"
For the products with the exclusive purpose of cooling only, "AI" is indicated at the temperature display section.





-  When cold
-  When cool
-  When appropriate
-  When warm
-  When hot

Standard Operation - Fan Mode

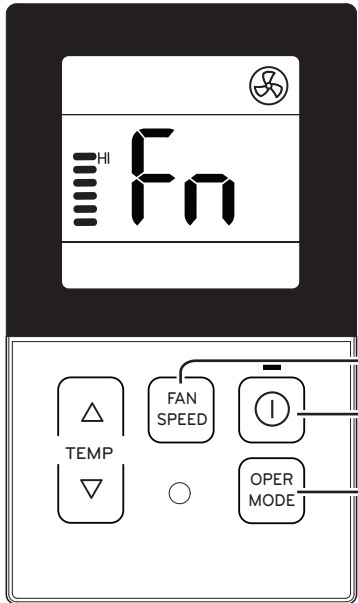
It blows the air as it is in the indoor, not the cold wind.



The diagram shows a control panel with a digital display. The display shows a fan icon and the letters 'Fn'. To the left of the display are five horizontal bars of varying heights, with 'HI' above them. Below the display are four buttons: 'TEMP' with up and down arrows, 'FAN SPEED' with a fan icon, 'OPER MODE' with a power button icon, and a small circular button. Lines connect the 'FAN SPEED' and 'OPER MODE' buttons to the numbered instructions on the right.



- 1 After operating the product by pressing the  button, set up the fan operation by pressing the  button.
- 2 When the dry operation is selected, "Fn" will be shown on the display window as shown on the left side.
 - The temperature setting can not be adjusted during operation this mode.
- 3 Press the  button to select airflow rate [LO→MED→HI].
When running ventilation, compressor of AHU doesn't work.

- Ventilation drive does not release cool wind but general fan
- Because it releases the wind that has no temperature difference from the room, it functions to circulate the inside air.
- The menu item of wind powerfulness might not be partially selected according to the product.

Function Setting - Fan Speed Selection

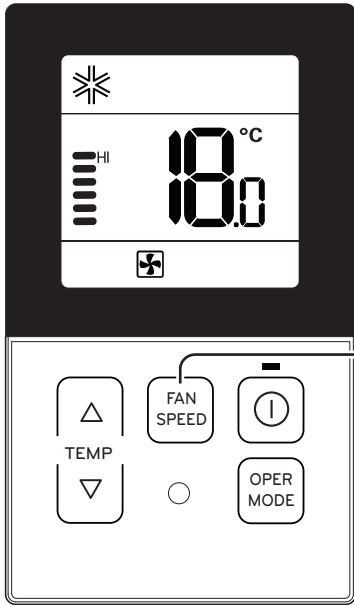
It blows the air as it is in the indoor, not the cold wind.



- 1 Select the proper fan speed which you want by pressing the  button on the remote controller.
 - If you press the  button, the fan speed will change in the order of [LO→MED→HI].
 - The initial fan speed is "Hi".
 - If the product is not compatible with the fan speed control, it will not function as per your selection.

Fan Speed Selection in Cooling Operation

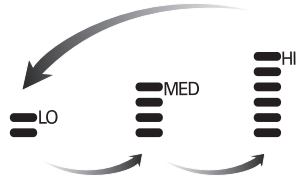

Fan Speed Selection in Heating, Dry, Fan, Auto-Operation

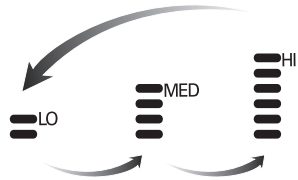

Standard Operation - Temperature Setting/Room Temperature Check

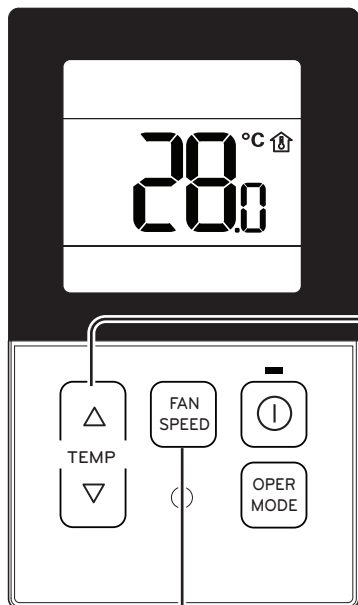

Temperature Setting

- 1 We can simply adjust the desired temperature.
 - Press the buttons to adjust the desired temperature.
 - : Increase 1 °C or 2 °F per one time pressing
 - : Decrease 1 °C or 2 °F per one time pressing
 - Room temp : Indicate the current room temperature.
 - Set temp : Indicate the temperature that user want to set.
- * Depend on what kind of controller, the desired temperature can be adjusted at 0.5 °C or 1 °F.

Cooling operation:

- The cooling mode doesn't work if desired temperature is higher than room temperature. Please lower the desired temperature.

Room Temperature Check

- 1 When pressing the button of the remote controller adjustment section for approx. 3 seconds, the room temperature will be indicated for about 5 seconds before resuming to the previous display panel.

In the case of the room temperature display, the room temperature can be different in accordance with the setting of the remote controller's room temperature detection selection.



- For air-cooling drive, from 18 °C to 30 °C, and for heating drive, from 16 °C to 30 °C, you can select desired temperature.

- 5 °C is proper for the difference between room and outside temperature.

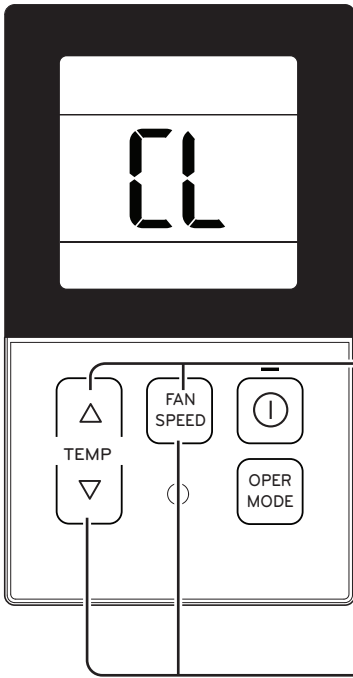

Function setting - Child Lock



It is the function to use preventing children or others from careless using.



1 During the operation, when pressing the  button and  button for approx. 3 seconds, the 'Child Lock' function can be used.

- At the time of initial setting of the 'Child Lock', the 'CL' will be indicated approx. 3 seconds at the temperature display section before resuming to the previous mode. After the setting of the 'CL', if another button is setup, the button can not be recognized as the 'CL' is indicated at the temperature display section for approx. 3 seconds.

2 If the 'CL' function is wanted to be used under the operation standby state, press the  button and  button for approx. 3 seconds under the standby mode state and the system will be the 'CL' state.

3 As for the releasing method, when pressing the  button and  button for approx. 3 seconds, the 'CL' function can be released.

MAINTENANCE AND SERVICE

! CAUTION

Before performing any maintenance, turn off the main power to the system.

Grille, Case and Remote Control

- Turn the system off before cleaning. To clean, wipe with a soft, dry cloth. Do not use bleach or abrasives.

! NOTE

- Power supply must be disconnected before cleaning the indoor unit.

Air Filters

The air filters behind the air inlet vent should be checked and cleaned once every 2 weeks or more often if necessary.

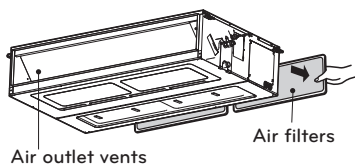

- Never use any of the followings:
Water hotter than 40 °C.
Could cause deformation and or discoloration.
Volatile substances.
Could damage the surfaces of the air conditioner.

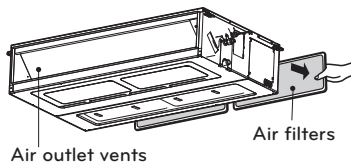

- Remove the air filters.
Take hold of the tab and pull slightly forward to remove the filter.

! CAUTION

When the air filter is to be removed, do not touch the metal parts of the indoor unit. It may cause an injury.

- Clean dirt from the air filter using a vacuum cleaner or washing with water.
If dirt is conspicuous, wash with a neutral detergent in lukewarm water.
If hot water (40 °C or more) is used, it may be deformed.
- After washing with water, dry well in the shade.
Do not expose the air filter to direct sunlight or heat from a fire when drying it.
- Install the air filter.

When the air conditioner is not going to be used for a long time.

When it is not going to be used for a long time.

- Operate the air conditioner at the following settings for 2 to 3 hours.
Type of operation: Fan operation mode.
This will dry out the internal mechanisms.
- Turn off the breaker.



CAUTION

Turn off the breaker when the air conditioner is not going to be used for a long time.
Dirt may collect and may cause a fire.

Helpful information

The air filters and your electric bill.
If the air filters become clogged with dust, the cooling capacity will drop, and 6 % of the electricity used to operate the air conditioner will be wasted.

When the air conditioner is to be used again.

- Clean the air filter and install it in the indoor unit.
- Check that the air inlet and outlet of the indoor/outdoor unit are not blocked.
- Check that the ground wire is connected correctly. It may be connect to the indoor unit side.

Operation Tips!

<p>Do not overcool the room. This is not good for the health and wastes electricity.</p>	<p>Keep blinds or curtains closed. Do not let direct sunshine enter the room when the air conditioner is in operation.</p>	<p>Keep the room temperature uniform. Adjust the vertical and horizontal airflow direction to ensure a uniform temperature in the room.</p>
<p>Make sure that the doors and windows are shut tight. Avoid opening doors and windows as much as possible to keep the cool air in the room.</p>	<p>Clean the air filter regularly. Blockages in the air filter reduce the airflow and lower cooling and dehumidifying effects. Clean at least once every two weeks.</p>	<p>Ventilate the room occasionally. Since windows are kept closed, it is a good idea to open them and ventilate the room now and then.</p>

Troubleshooting Tips! Save time and money!

Check the following points before requesting repairs or service.... If the malfunction persist, please contact your dealer.

<p>The air conditioner does not operate.</p> <ul style="list-style-type: none"> - Have you made a mistake in timer operation? - Has the fuse blown or has the circuit breaker been tripped? 	<p>The room has a peculiar odor.</p> <ul style="list-style-type: none"> - Check that this is not a damp smell exuded by the walls, carpet, furniture or cloth items in the room. 	<p>It seems that condensation is leaking from the air conditioner.</p> <ul style="list-style-type: none"> - Condensation occurs when the airflow from the air conditioner cools the warm room air. 	<p>Air conditioner does not operate for about 3 minutes when restart.</p> <ul style="list-style-type: none"> - This is the protector of the mechanism. - Wait about three minutes and operation will begin.
<p>Does not cool or heat effectively.</p> <ul style="list-style-type: none"> - Is the air filter dirty? See air filter cleaning instructions. - The room may have been very hot when the room air conditioner was first turned on. Allow time for it to cool down. - Has the temperature been set incorrectly? - Are the indoor unit's air inlet or outlet vents obstructed? 	<p>The air conditioner operation is noisy.</p> <ul style="list-style-type: none"> - For a noise that sounds like water flowing. <ul style="list-style-type: none"> * This is the sound of freon flowing inside the air conditioner unit. - For a noise that sounds like the compressed air releasing into atmosphere. <ul style="list-style-type: none"> * This is the sound of the dehumidifying water being processed inside the air conditioning unit. 	<p>Crack sound is heard.</p> <ul style="list-style-type: none"> - This sound is generated by the expansion/ constriction of the front panel, etc. due to changes of temperature. <p>Filter sign lamp (LED) is ON.</p> <ul style="list-style-type: none"> - Cleaning the filter, press the Timer button and ◀ button of wired remote controller at the same time for 3 sec. 	<p>Remote control display is faint, or no display at all.</p> <ul style="list-style-type: none"> - Are the batteries depleted? - Are the batteries inserted in the opposite (+) and (-) directions?

! NOTE

WATER RESISTANT : The outdoor side of this appliance is WATER RESISTANT. The indoor side is not water resistant and should not be exposed to excess water.

Specifications.

Model	Voltage / Hz	Max. Current
ABNQ18GM1A2, ABNQ24GM1A2	220 V~ 50/60 Hz	1.6 A
ABNQ36GM2A2, ABNQ48GM3A2	220 V~ 50/60 Hz	2.3 A
ABNQ54GM3A2	220 V~ 50/60 Hz	2.4 A
AUUQ18GH2(ABUQ18GM1A2)	220 V~ 50/60 Hz	9.5 A
AUUQ24GH2(ABUQ24GM1A2)	220 V~ 50/60 Hz	14.0 A
AUUQ36GH2(ABUQ36GM2A2)	220 V~ 50/60 Hz	19.0 A
AUUQ48GH2(ABUQ48GM3A2)	220 V~ 50/60 Hz	29.0 A
AUUQ54GH2(ABUQ54GM3A2)	220 V~ 50/60 Hz	29.0 A

Model	Voltage / Hz	Max.
		Current
ABNQ22GM1A4	220~240 V, 50/60 Hz	1.6 A
ABNQ30GM1A4	220~240 V, 50/60 Hz	1.6 A
ABNQ40GM3A4	220~240 V, 50/60 Hz	1.9 A
ABNQ50GM3A4	220~240 V, 50/60 Hz	1.9 A
ABNQ60GM3A4	220~240 V, 50/60 Hz	1.9 A
ABUQ22GM1A4	220~240 V, 50/60 Hz	11.0 A
ABUQ30GM1A4	220~240 V, 50/60 Hz	19.0 A
AUUQ40GH4	220~240 V, 50/60 Hz	21.0 A
AUUQ50GH4	220~240 V, 50/60 Hz	23.0 A
AUUQ60GH4	220~240 V, 50/60 Hz	29.0 A



Model / Modelo (s) :

ABNQ18GM1A2, ABNQ24GM1A2, ABNQ36GM2A2, ABNQ48GM3A2, ABNQ54GM3A2,
ABNQ22GM1A4, ABNQ30GM1A4, ABNQ40GM3A4, ABNQ50GM3A4, ABNQ60GM3A4

AUUQ18GH2(ABUQ18GM1A2), AUUQ24GH2(ABUQ24GM1A2),
AUUQ36GH2(ABUQ36GM2A2), AUUQ48GH2(ABUQ48GM3A2)
AUUQ54GH2(ABUQ54GM3A2)
ABUQ22GM1A4, ABUQ30GM1A4, AUUQ40GH4, AUUQ50GH4, AUUQ60GH4

LG Electronics México, S.A. de C.V

Sor Juana Inés de la Cruz No. 555
Col. San Lorenzo Industrial
Tlalnepantla de Baz, Estado de México
C.P. 54033
TEL. 55 5321 1919
Teléfono sin costo 01 800 347 1919
Página web <http://www.lg.com.mx>

