

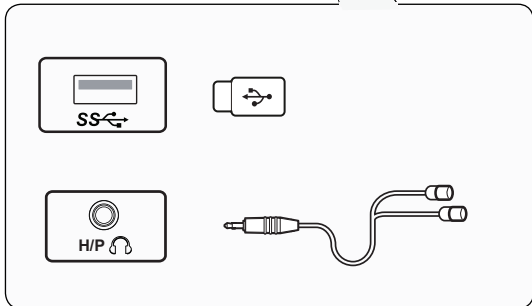

27BA75QB

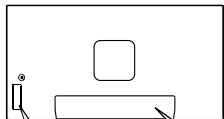

DP-IN



DP-OUT



HDMI™

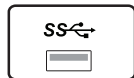

SS

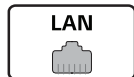

LAN

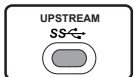

UPSTREAM
SS

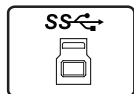

SS

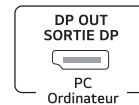

DP OUT
SORTIE DP

PC
Ordinateur



DP IN
ENTREE DP

MNT

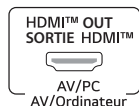

HDMI™ OUT
SORTIE HDMI™

AV/PC
AV/Ordinateur

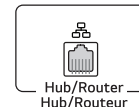

Hub/Router
Hub/Routeur

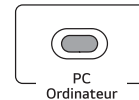

PC
Ordinateur

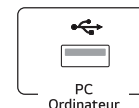

PC
Ordinateur



27BA65QB

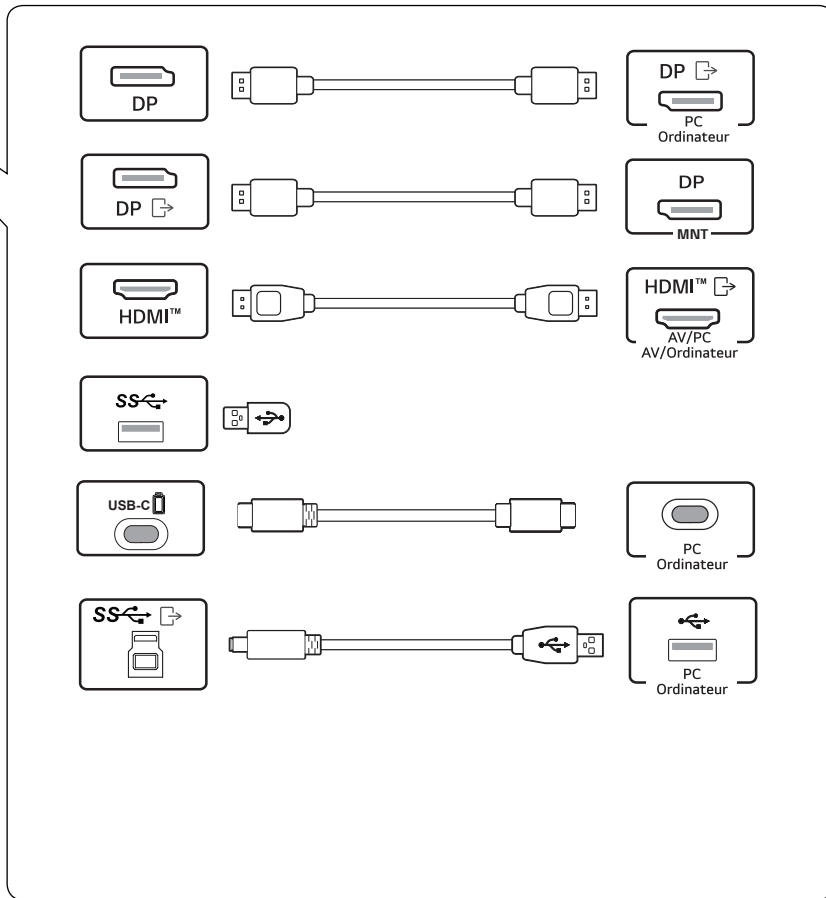
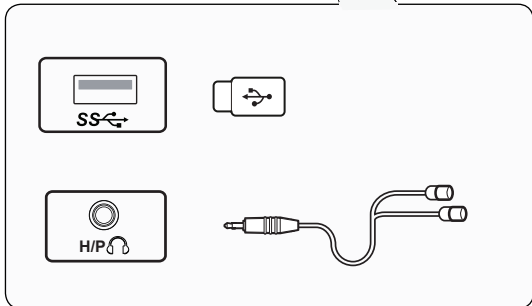
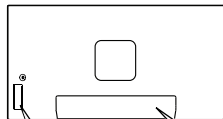



English **ARBITRATION NOTICE (USA) / États-Unis seulement**

By using this product, you agree that all disputes between you and LG arising out of or relating in any way to this product (including but not limited to warranty disputes) shall be resolved through binding arbitration on an individual basis, unless the laws of your state or territory do not permit that, or, in other jurisdictions, if you choose to opt out.

Additional information regarding the terms of the arbitration agreement (including details on the procedure for resolving disputes) is available at www.lg.com/us/arbitration (USA) and/or your owner's manual or warranty.

Español **AVISO DE ARBITRAJE (EE. UU.)**

Al utilizar este producto, usted acepta que todas las disputas entre usted y LG que surjan de este producto o se relacionen de alguna manera con él (incluidas, entre otras, las disputas de garantía) se resolverán mediante arbitraje vinculante de forma individual, a menos que las leyes de su estado o territorio no lo permitan, o en otras jurisdicciones, si decide optar por no participar. Los sitios web www.lg.com/us/arbitration (EE. UU.) y/o el manual del propietario o la garantía contienen información adicional sobre los términos del acuerdo de arbitraje (incluidos detalles sobre el procedimiento para resolver disputas).

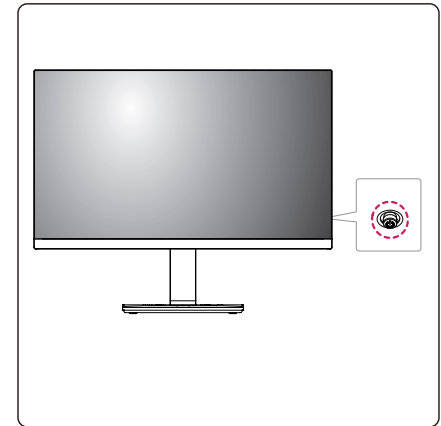
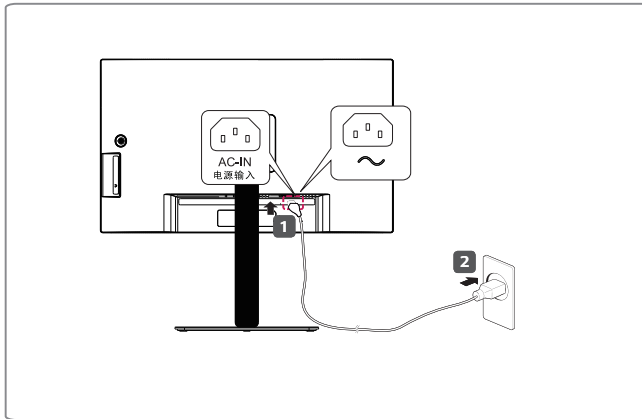



English	Dimensions (Width x Height x Depth)		Weight		Recommend Resolution
	With Stand	Without Stand	With Stand	Without Stand	
	613.5 x 539.5 x 250 (mm) 24.1 x 21.2 x 9.8 (inches)	613.5 x 363.5 x 63 (mm) 24.1 x 14.3 x 2.4 (inches)	8.1 kg (17.8 lbs)	5.3 kg (11.6 lbs)	
Français	Dimensions (largeur x hauteur x profondeur)		Poids		Résolution recommandée
	Socle inclus	Socle non inclus	Socle inclus	Socle non inclus	
	613,5 x 539,5 x 250 (mm) 24,1 x 21,2 x 9,8 (po)	613,5 x 363,5 x 63 (mm) 24,1 x 14,3 x 2,4 (po)	8,1 kg (17,8 lb)	5,3 kg (11,6 lb)	
Español	Dimensiones (ancho x alto x profundo)		Peso		Resolución recomendada (Píxeles)
	Pie incluido	Pie no incluido	Pie incluido	Pie no incluido	
	613,5 x 539,5 x 250 (mm)	613,5 x 363,5 x 63 (mm)	8,1 kg	5,3 kg	
Clasificación de potencia		100-240 V~ 50/60 Hz 2,5 A			