



OWNER'S MANUAL

# LG UltraGear™

## Gaming Monitor

(LED Monitor\*)

\* LG LED Monitor applies LCD screen with LED backlights.

Please read this manual carefully before operating your set and retain it for future reference.

24GN600/24GN600P

24GN60T/24GN60TP

27GN600/27GN600P

32GN600

32GK60W

[www.lg.com](http://www.lg.com)

Copyright © 2019 LG Electronics Inc. All Rights Reserved.

# TABLE OF CONTENTS

## LICENSE.....3

## OPEN SOURCE SOFTWARE

## NOTICE INFORMATION .....4

## ASSEMBLING AND PREPARING 4

- Supported Drivers and Software ..... 5
- Product and Button Description..... 5
  - How to Use the Joystick Button
- Moving and Lifting the Monitor..... 6
  - Installing on a Table
  - Adjusting the Angle
  - Tidying up Cables (27GN600, 27GN600P, 32GN600, 32GK60W)
  - Using the Kensington Lock
  - Installing the Wall Mount Plate
  - Installing on the Wall

## USING THE MONITOR..... 13

- Connecting to a PC..... 14
  - HDMI Connection
  - DisplayPort Connection
- Connecting AV Devices..... 15
  - HDMI Connection
- Connecting Peripherals..... 15
  - Connecting Headphones
- Upgrading the Software via USB..... 16

## USER SETTINGS ..... 17

- Activating the Main Menu ..... 17
  - Main Menu Features
- User Settings..... 19
  - Menu Settings

## TROUBLESHOOTING..... 32

## PRODUCT SPECIFICATION ..... 35

- Factory Support Mode..... 41
- HDMI Timing (Video)..... 43
- Power LED ..... 45
- Beep Guide ..... 46

## LIMITED WARRANTY (USA) ... 58

## LIMITED WARRANTY (CANADA) ..... 61

# LICENSE

Each model has different licenses. Visit [www.lg.com](http://www.lg.com) for more information on the license.



The terms HDMI, HDMI High-Definition Multimedia Interface, HDMI trade dress and the HDMI Logos are trademarks or registered trademarks of HDMI Licensing Administrator, Inc.

## OPEN SOURCE SOFTWARE NOTICE INFORMATION

To obtain the source code that is contained in this product, under GPL, LGPL, MPL, and other open source licenses that have the obligation to disclose source code, and to access all referred license terms, copyright notices and other relevant documents, please visit <https://opensource.lge.com>.

LG Electronics will also provide open source code to you on CD-ROM for a charge covering the cost of performing such distribution (such as the cost of media, shipping, and handling) upon email request to [opensource@lge.com](mailto:opensource@lge.com).

This offer is valid to anyone in receipt of this information for a period of three years after our last shipment of this product.

## ASSEMBLING AND PREPARING

### CAUTION

- Always use genuine LG components to ensure safety and product performance.
- The product warranty will not cover damage or injury caused by the use of unauthorized components.
- It is recommended that use the supplied components.
- If you use generic cables not certified by LG, the screen may not display or there may be image noises.
- Illustrations in this document represent typical procedures, so they may look different from the actual product.
- Do not apply foreign substances (oils, lubricants, etc.) to the screw parts when assembling the product. (Doing so may damage the product.)

- Applying excessive force when tightening screws may cause damage to the monitor. Damage caused in this way will not be covered by the product warranty.
- Do not carry the monitor upside down by just holding the base. This may cause the monitor to fall off the stand and could result in personal injury.
- When lifting or moving the monitor, do not touch the monitor screen. The force applied to the monitor screen may cause damage to it.
- For wave pattern on appearance, unlike the general method of coating, it's applied to added glittering material in raw material. With no peeled-off appearance, it has good durability. Please use it with confidence because there is no problem in using the product at all.

### NOTE

- The components may look different from those illustrated here.
- Without prior notice, all product information and specifications contained in this manual are subject to change to improve the performance of the product.
- To purchase optional accessories, visit an electronics store or an online shopping site, or contact the retailer from which you purchased the product.
- The power cord provided may differ depending upon the region.

## Supported Drivers and Software

You can download and install the latest version from the LGE website ([www.lg.com](http://www.lg.com)).

Drivers and Software	Installation Priority
Monitor Driver	Recommended
OnScreen Control	Recommended

## Product and Button Description

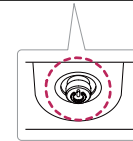





**Joystick Button**

## How to Use the Joystick Button

You can easily control the functions of the monitor by pressing the joystick button or moving it left/right with your finger.

### Basic Functions

		<b>Power on</b>	Press the joystick button once with your finger to turn on the monitor.
		<b>Power off</b>	Press and hold the joystick button once with your finger to turn off the monitor.
		<b>Volume control</b>	You can control the volume by moving the joystick button left/right.

### NOTE

- The joystick button is located at the bottom of the monitor.

## Moving and Lifting the Monitor

When moving or lifting the monitor, follow these instructions to prevent the monitor from being scratched or damaged and to ensure safe transportation, regardless of its shape or size.

- Place the monitor in the original box or packing material before attempting to move it.
- Before moving or lifting the monitor, disconnect the power cord and all other cables.
- Hold the bottom and side of the monitor frame firmly. Do not hold the panel itself.

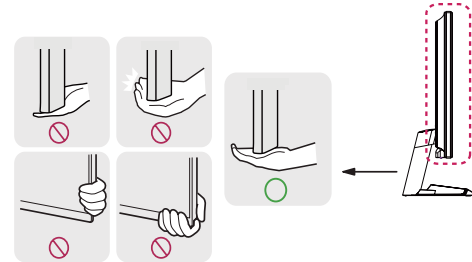

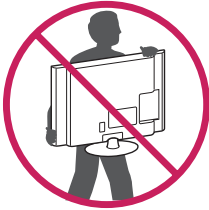

- When holding the monitor, the screen should face away from you to prevent it from being scratched.
- When transporting the monitor, do not expose the monitor to shock or excessive vibration.
- When moving the monitor, keep it upright and never turn the monitor on its side or tilt it sideways.



### CAUTION

- Avoid touching the monitor screen as much as possible.
  - This may result in damage to the screen or some of the pixels used to create images.

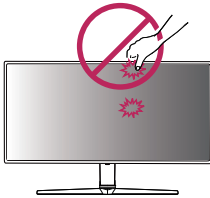

- If you use the monitor panel without the stand base, its joystick button may cause the monitor to become unstable and fall, resulting in damage to the monitor or human injury. In addition, this may cause the joystick button to malfunction.

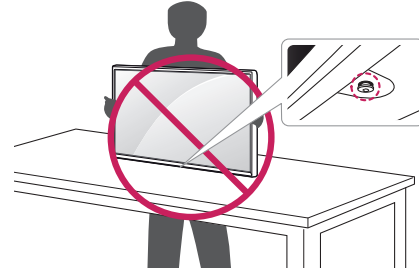

## Installing on a Table

- Lift the monitor and place it on the table in an upright position. Place the monitor at least 100 mm (3.94 inches) away from the wall to ensure sufficient ventilation.

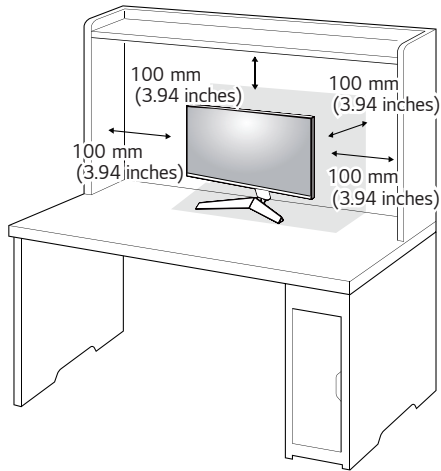

## CAUTION

- Unplug the power cord before moving or installing the monitor. There is risk of electric shock.
- Make sure to use the power cord that is provided in the product package and connect it to a grounded power outlet.
- If you need another power cord, please contact your local dealer or the nearest retail store.



## Adjusting the Angle

- 1 Place the monitor mounted on the stand base in an upright position.
  - 2 Adjust the angle of the screen.
- The angle of the screen can be adjusted forward or backward from  $-5^{\circ}$  to  $15^{\circ}$  for a comfortable viewing experience.

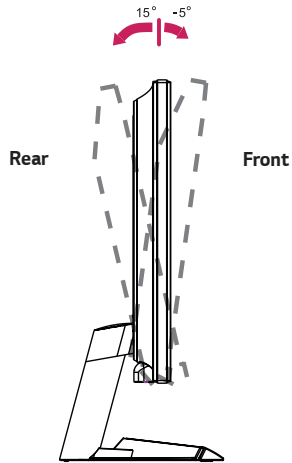

## WARNING

- To avoid injury to the fingers when adjusting the screen, do not hold the lower part of the monitor's frame as illustrated below.

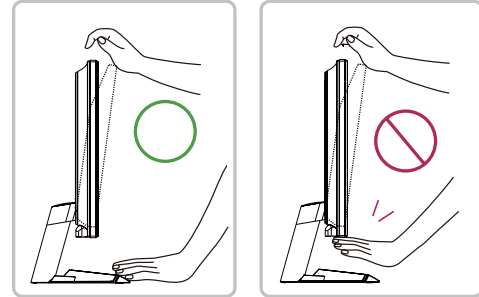

- Be careful not to touch or press the screen area when adjusting the angle of the monitor.

### Tidying up Cables (27GN600, 27GN600P, 32GN600, 32GK60W)

Arrange the cables using the cable holder as shown in the illustration.

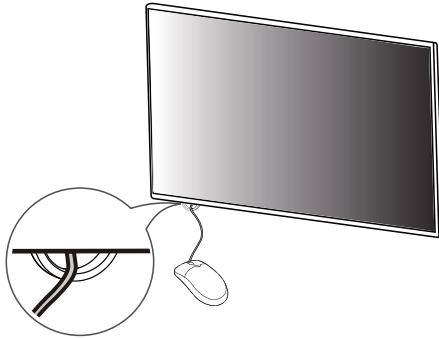

### Using the Kensington Lock

The connector for the Kensington security system is located at the bottom of the monitor.

For more information on installation and usage, refer to the Kensington lock owner's manual or visit the website at <http://www.kensington.com>.

Connect the monitor to a table using the Kensington security system cable.

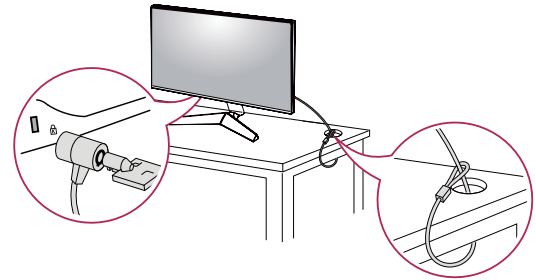

### ! NOTE

- The Kensington security system is optional. You can obtain optional accessories from most electronics stores.

## Installing the Wall Mount Plate

This monitor meets the specifications for the wall mount plate or other compatible devices.

- 1 Place the screen face down. To protect the monitor panel (screen), cover the surface with a soft cloth or the monitor protection pad included in the product package.
- 2 Remove the four screws tightened on the back of the monitor.
- 3 Place the wall mount plate onto the monitor and align it with the screw holes.
- 4 Tighten the four screws using a screwdriver to fix the plate to the monitor.

### NOTE

- The wall mount plate is sold separately.
- For more information on installation, refer to the wall mount plate's installation guide.
- Be careful not to apply too much force while mounting the wall mount plate as it may cause damage to the screen.

## Installing on the Wall

Install the monitor at least 100 mm (3.94 inches) away from the wall and leave about 100 mm (3.94 inches) of space at each side of the monitor to ensure sufficient ventilation. Detailed installation instructions can be obtained from your local retail store. Alternatively, please refer to the manual for how to install and set up a tilting wall mounting bracket.

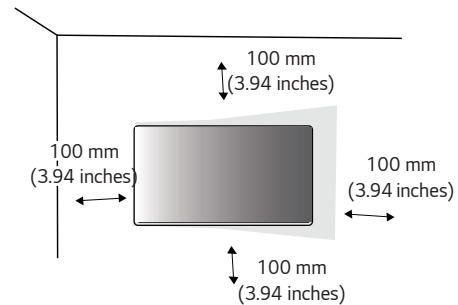

To install the monitor to a wall, attach a wall mounting bracket (optional) to the back of the monitor.

Make sure that the wall mounting bracket is securely fixed to the monitor and to the wall.

- 1 If you use screws longer than the standard length, it may damage the inside of the product.
- 2 A non-VESA standard screw may damage the product and cause the monitor to fall. LG Electronics is not liable for any accidents relating to the use of non-standard screws.

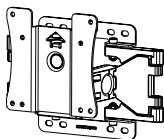
<b>Wall Mount (mm)</b>	100 x 100
<b>Standard screw</b>	M4 x L10
<b>Number of screws</b>	4
<b>Wall Mount Plate (Optional)</b>	LSW 149 

### ! NOTE

- Use the screws specified by VESA standards.
- The wall mount kit includes the installation guide and all necessary parts.
- The wall mounting bracket is optional. You can obtain optional accessories from your local dealer.
- The length of the screw may differ for each wall mounting bracket. Be sure to use the proper length.
- For more information, please refer to the user manual for the wall mounting bracket.

### ! CAUTION

- Unplug the power cord before moving or installing the monitor to avoid electric shock.
- Installing the monitor on the ceiling or on a slanted wall may result in the monitor falling off, which could lead to injury. Use an authorized LG wall mount and contact the local dealer or qualified personnel.
- Applying excessive force when tightening screws may cause damage to the monitor. Damage caused in this way will not be covered by the product warranty.

- Use the wall mounting bracket and screws that conform to VESA standards. Damage caused by the use or misuse of inappropriate components will not be covered by the product warranty.
- When measured from the back of the monitor, the length of each installed screw must be 8 mm (0.3 inches) or less.

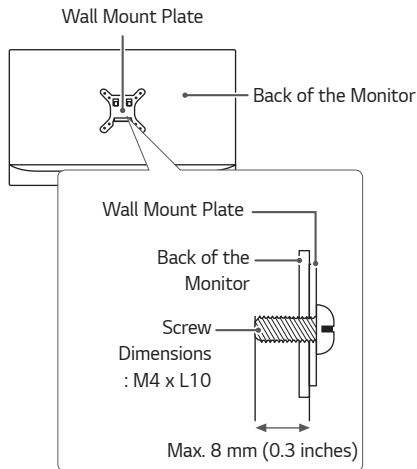

## USING THE MONITOR

- Illustrations in this manual may differ from the actual product. Press the joystick button, go to **Menu** → **Input**, and then select the input option.



### CAUTION

- Do not press the screen for a prolonged time. This may cause image distortion.
- Do not display a still image on the screen for a prolonged time. This may cause image retention. Use a screensaver if possible.



### NOTE

- When connecting the power cord to the outlet, use a grounded (3-hole) power strip or a grounded power outlet.
- The monitor may flicker when turned on in an area where the temperature is low. This is normal.
- Sometimes red, green, or blue spots may appear on the screen. This is normal.

## Connecting to a PC

- This monitor supports the \*Plug and Play feature.
- \* Plug and Play: A feature that allows you to add a device to your computer without having to reconfigure anything or install any manual drivers.

### HDMI Connection

Transmits digital video and audio signals from your PC to the monitor.



#### CAUTION

- Using a DVI to HDMI / DP (DisplayPort) to HDMI cable may cause compatibility issues.
- Use a certified cable with the HDMI logo attached. If you do not use a certified HDMI cable, the screen may not display or a connection error may occur.
- Recommended HDMI cable types
  - High-Speed HDMI®/TM cable
  - High-Speed HDMI®/TM cable with Ethernet

### DisplayPort Connection

Transmits digital video and audio signals from your PC to the monitor.



#### NOTE

- There may be no video or audio output depending on the DP (DisplayPort) version of the PC.
- If you are using a Mini DisplayPort output graphics card, use a Mini DP to DP (Mini DisplayPort to DisplayPort) cable or gender that supports DisplayPort1.4. (sold separately)

## Connecting AV Devices

### HDMI Connection

HDMI transmits digital video and audio signals from your AV device to the monitor.

#### ! NOTE

- Using a DVI to HDMI / DP (DisplayPort) to HDMI cable may cause compatibility issues.
- Use a certified cable with the HDMI logo attached. If you do not use a certified HDMI cable, the screen may not display or a connection error may occur.
- Recommended HDMI cable types
  - High-Speed HDMI<sup>®/TM</sup> cable
  - High-Speed HDMI<sup>®/TM</sup> cable with Ethernet

## Connecting Peripherals

### Connecting Headphones

Connect peripherals to the monitor via the headphones port.

#### ! NOTE

- Peripheral devices are sold separately.
- If you use angled earphones, it may cause a problem with connecting another external device to the monitor. Therefore, it is recommended to use straight earphones.



Angled

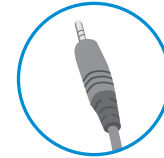

Straight  
(Recommend)

- Depending on the audio settings of the PC and external device, headphones and speaker functions may be limited.

## Upgrading the Software via USB

(24GN600, 24GN600P, 24GN60T, 24GN60TP, 27GN600, 27GN600P)

- 1 Remove the cover or sheet when using USB port (  ).

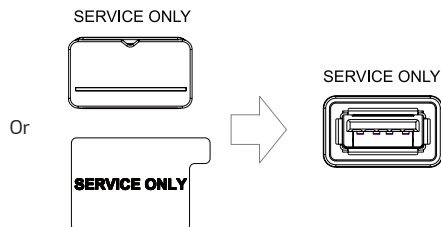

- 2 When the monitor screen operates normally, insert the USB storage device containing the upgrade software in the USB port (  ).
- 3 When the software upgrade message appears, select OK to start the upgrade.
- 4 Your Monitor will turn itself off and on again automatically after completing software upgrade.

### ! NOTE

- The USB port can only be used for software upgrade.
  - Use only those USB storage devices formatted with FAT, FAT32 or NTFS File System provided by Windows.
  - USB storage devices with a built-in auto recognition program or their own driver may not work.
  - Some USB storage devices may not work or may work improperly.
  - Do not turn off the monitor or remove your storage device during the upgrade process.
  - The upgrade file should be located in the LG\_MNT folder under the root directory of USB storage device.
  - You can download the upgrade file from the LGE website. (This is available on certain models only.)
- ※ For detailed guide, please refer to the LGE website provided with the upgrade file.



# USER SETTINGS



## ! NOTE

- Your monitor's OSD (On Screen Display) may differ slightly from that shown in this manual.
- When **Beep Guide** is activated, pressing the joystick button will take you to **Menu** right away.

## Activating the Main Menu

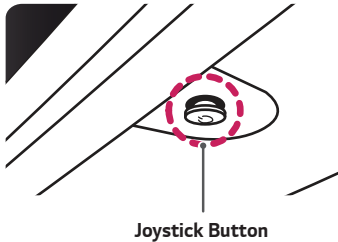
- 1 Press the joystick button on the bottom of the monitor.
- 2 Move the joystick up/down (▲ / ▼) and left/right (◀ / ▶) to set the options.
- 3 Press the joystick button once more to exit the main menu.



Button	Menu Status	Description
	<b>Main menu disabled</b>	Enables the main menu.
	<b>Main menu enabled</b>	Exits the main menu. (Holding down the button to turn off the monitor. You can turn off the monitor this way at any time, including when the OSD is on.)
	◀ <b>Main menu disabled</b>	Adjusts the monitor volume level.
	◀ <b>Main menu enabled</b>	Enters the <b>Input</b> features.
	▶ <b>Main menu disabled</b>	Adjusts the monitor volume level.
	▶ <b>Main menu enabled</b>	Enters the <b>Menu</b> feature.
	▲ <b>Main menu disabled</b>	Enters the <b>Accessibility</b> menu.
	▲ <b>Main menu enabled</b>	Turns off the monitor.
	▼ <b>Main menu disabled</b>	Enters the <b>Accessibility</b> menu.
	▼ <b>Main menu enabled</b>	Enters the <b>Game Mode</b> feature.

## Main Menu Features

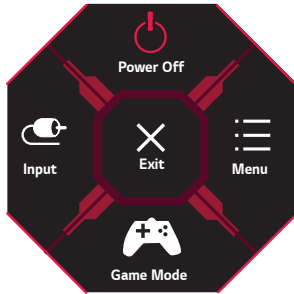

Main Menu	Description
<b>Input</b>	Sets input mode.
<b>Power Off</b>	Turns off the monitor.
<b>Menu</b>	Configures the screen settings.
<b>Game Mode</b>	Sets the game mode for gaming.
<b>Exit</b>	Exits the main menu.

## User Settings

### Menu Settings

- 1 To view the OSD menu, press the joystick button at the bottom of the monitor and then enter the **Menu**.
- 2 Configure the options by moving the joystick up/down/left/right.
- 3 To return to the upper menu or set other menu items, move the joystick to ◀ or pressing (⏻) it.
- 4 If you want to exit the OSD menu, move the joystick to ◀ until you exit.



Game Mode



Game Adjust



Picture Adjust



Input



General

Game Mode on SDR(Non-HDR)signal.



Menu > Game Mode		Description
Game Mode	<b>Gamer 1</b>	In this mode, users can customize elements including game-related options.
	<b>Gamer 2</b>	<b>Gamer 1</b> and <b>Gamer 2</b> picture modes allow you to save two sets of customized display settings, including game-related setup options.
	<b>FPS</b>	This mode is optimized for FPS games.
	<b>RTS</b>	This mode is optimized for RTS Game.
	<b>Vivid</b>	Optimized the screen for vivid colors.
	<b>Reader</b>	Optimizes the screen for viewing documents. You can brighten the screen in the OSD menu.
	<b>HDR Effect</b>	Optimizes the screen for high dynamic range.

Game Mode on HDR signal.

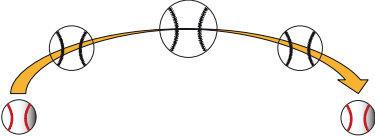
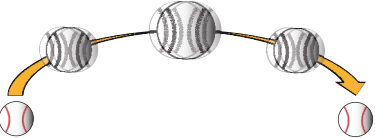
Menu > Game Mode		Description
Game Mode	<b>Gamer 1</b>	In this mode, users can customize elements including game-related options.
	<b>Gamer 2</b>	<b>Gamer 1</b> and <b>Gamer 2</b> picture modes allow you to save two sets of customized display settings, including game-related setup options.
	<b>FPS</b>	This mode is optimized for FPS games.It is suitable for very dark FPS games.
	<b>RTS</b>	This mode is optimized for RTS Game.
	<b>Vivid</b>	Optimized the screen for vivid colors.
	 <b>NOTE</b> <ul style="list-style-type: none"> <li>• HDR content may not be operated properly depending on the Windows10 OS setting. Please check the HDR On / Off setting of Windows.</li> <li>• When the HDR function is turned on, the characters or picture quality may be poor according to Graphic card performance.</li> <li>• While the HDR function is on, screen flickering or cracking may occur when changing the monitor input or power on/off according to Graphic card performance.</li> </ul>	

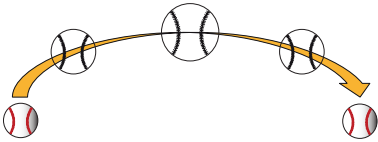
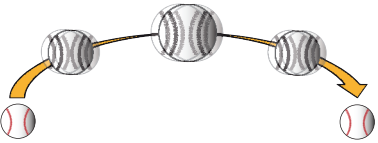
Menu > Game Adjust		Description
Game Adjust	1ms Motion Blur Reduction (for 32GN600,32GK60W)	<p><b>On</b></p> <p>This mode minimizes motion blur in fast-moving videos. To take full advantage of this function, select 2560 x 1440 @ 120Hz/144Hz/165Hz before enabling <b>1ms Motion Blur Reduction</b>.</p>  <p>This function is available for the following vertical frequency. (120Hz/144Hz/165Hz)</p>
		<p><b>Off</b></p> <p>Turns <b>1ms Motion Blur Reduction</b> Mode off.</p> 
		<p><b>NOTE</b></p> <ul style="list-style-type: none"> <li>• To reduce motion blur, brightness is reduced with backlight control.</li> <li>• <b>1ms Motion Blur Reduction</b> and <b>FreeSync</b> feature can not used at the same time.</li> <li>• This function is game-optimized.</li> <li>• It is recommended to turn off when you are not using the gaming function.</li> <li>• Flicker may occur during <b>1ms Motion Blur Reduction</b> operation.</li> </ul>

Game Adjust	<b>Motion Blur Reduction</b> (for 24GN600, 24GN600P, 24GN60T, 24GN60TP, 27GN600, 27GN600P)	On	<p>This mode minimizes motion blur in fast-moving videos. To take full advantage of this function, select 1920 x 1080 @ 120Hz/144Hz before enabling <b>Motion Blur Reduction</b>.</p>  <p>This function is available for the following vertical frequency. (120Hz/144Hz)</p>
		Off	<p>Turns <b>Motion Blur Reduction</b> Mode off.</p> 
		<p><b>!</b> <b>NOTE</b></p> <ul style="list-style-type: none"> <li>• To reduce motion blur, brightness is reduced with backlight control.</li> <li>• <b>Motion Blur Reduction</b> and <b>FreeSync</b> feature can not used at the same time.</li> <li>• This function is game-optimized.</li> <li>• It is recommended to turn off when you are not using the gaming function.</li> <li>• Flicker may occur during <b>Motion Blur Reduction</b> operation.</li> </ul>	

Game Adjust	<b>FreeSync Premium (for 32GN600, 32GK60W)</b>	<p>Provides seamless and natural images by synchronizing the vertical frequency of the input signal with that of the output signal.</p> <p> <b>CAUTION</b></p> <ul style="list-style-type: none"> <li>• Supported Interface: DisplayPort,HDMI.</li> <li>• Supported Graphic Card : A graphic card that supports AMD's FreeSync is necessary.</li> <li>• Supported Version : Make sure to update the graphic card to the latest driver.</li> <li>• For more information and requirement, refer to AMD website at <a href="http://www.amd.com/FreeSync">http://www.amd.com/FreeSync</a></li> <li>• <b>FreeSync Premium</b> and <b>1ms Motion Blur Reduction</b> cannot be enabled simultaneously.</li> </ul>					
		<table border="1"> <tr> <td><b>On</b></td> <td>FreeSync function on.</td> </tr> <tr> <td><b>Off</b></td> <td>FreeSync function off.</td> </tr> </table>	<b>On</b>	FreeSync function on.	<b>Off</b>	FreeSync function off.	
		<b>On</b>	FreeSync function on.				
	<b>Off</b>	FreeSync function off.					
	<b>Adaptive-Sync (for 27GN600, 27GN600P)</b>	<p>Provides seamless and natural images by synchronizing the vertical frequency of the input signal with that of the output signal.</p> <p> <b>CAUTION</b></p> <ul style="list-style-type: none"> <li>• In HDMI input, the menu name is displayed as certified AMD FreeSync Tier name instead of <b>Adaptive-Sync</b>. (<b>FreeSync / FreeSync Premium / FreeSync Premium Pro</b>)</li> <li>• Supported Interface: DisplayPort (<b>Adaptive-Sync</b>), HDMI (<b>FreeSync</b>).</li> <li>• Supported Graphic Card : A graphic card that supports NVIDIA's G-SYNC or AMD's FreeSync is necessary.</li> <li>• Supported Version : Make sure to update the graphic card to the latest driver.</li> <li>• For more information and requirement, refer to NVIDIA website (<a href="http://www.nvidia.com">www.nvidia.com</a>) and AMD website (<a href="http://www.amd.com">www.amd.com</a>).</li> <li>• <b>Adaptive-Sync</b> and <b>Motion Blur Reduction</b> cannot be enabled simultaneously.</li> </ul>					
<table border="1"> <tr> <td><b>Extended</b></td> <td>Adaptive-Sync function on. (Enable wider frequency range of Adaptive-Sync(FreeSync) function than basic mode.)</td> </tr> <tr> <td><b>Basic</b></td> <td>Adaptive-Sync function on. (Enable basic frequency range of Adaptive-Sync(FreeSync) function.)</td> </tr> <tr> <td><b>Off</b></td> <td>Adaptive-Sync function off.</td> </tr> </table>		<b>Extended</b>	Adaptive-Sync function on. (Enable wider frequency range of Adaptive-Sync(FreeSync) function than basic mode.)	<b>Basic</b>	Adaptive-Sync function on. (Enable basic frequency range of Adaptive-Sync(FreeSync) function.)	<b>Off</b>	Adaptive-Sync function off.
<b>Extended</b>		Adaptive-Sync function on. (Enable wider frequency range of Adaptive-Sync(FreeSync) function than basic mode.)					
<b>Basic</b>		Adaptive-Sync function on. (Enable basic frequency range of Adaptive-Sync(FreeSync) function.)					
<b>Off</b>	Adaptive-Sync function off.						





<b>Game Adjust</b>	<b>FreeSync Premium (for 24GN600, 24GN600P, 24GN60T, 24GN60TP)</b>	Provides seamless and natural images by synchronizing the vertical frequency of the input signal with that of the output signal.	
		 <b>CAUTION</b> <ul style="list-style-type: none"> <li>• Supported Interface: DisplayPort,HDMI.</li> <li>• Supported Graphic Card : A graphic card that supports AMD's FreeSync is necessary.</li> <li>• Supported Version : Make sure to update the graphic card to the latest driver.</li> <li>• For more information and requirement, refer to AMD website at <a href="http://www.amd.com/FreeSync">http://www.amd.com/FreeSync</a></li> <li>• <b>FreeSync Premium</b> and <b>Motion Blur Reduction</b> cannot be enabled simultaneously.</li> </ul>	
		<b>Extended</b>	FreeSync Premium function on. (Enable wider frequency range of FreeSync function than basic mode.)
		<b>Basic</b>	FreeSync Premium function on. (Enable basic frequency range of FreeSync function.)
	<b>Off</b>	FreeSync Premium function off.	
	<b>Black Stabilizer</b>	You can control the black contrast to have better visibility in dark scenes. You can easily distinguish objects on dark game screens.	

<b>Game Adjust</b>	<b>Response Time</b>	Sets a response time for displayed pictures based on the speed of the screen. For a normal environment, it is recommended that you use <b>Fast</b> . For a fast-moving picture, it is recommended that you use <b>Faster</b> . Once <b>Faster Mode</b> is selected, <b>Motion Blur</b> may occur depending on the content.	
		<b>Faster</b>	Sets the response time to Faster.
		<b>Fast</b>	Sets the response time to Fast.
		<b>Normal</b>	Sets the response time to Normal.
		<b>Off</b>	Does not use the response time improvement feature.
	<b>Cross Hair</b>	Cross hair provides a mark on the center of the screen for First Person Shooter (FPS) games. Users can select the cross hair that fits their gaming environment among four different cross hairs. • When the monitor is off or enters energy saving mode, the cross hair feature is automatically turned off.	
	<b>Game Reset</b>	Do you want to reset your Game settings?	
		<b>No</b>	Cancel the select.
	<b>Yes</b>	Returns to the default settings.	

Menu > Picture Adjust		Description	
Picture Adjust	<b>Brightness</b>	Adjusts the brightness of the screen.	
	<b>Contrast</b>	Adjusts the contrast of the screen.	
	<b>Sharpness</b>	Adjusts the sharpness of the screen.	
	<b>Gamma</b>	<b>Mode 1, Mode 2, Mode 3</b>	The higher the gamma value, the darker the image becomes. Likewise, the lower the gamma value, the lighter the image becomes.
		<b>Mode 4</b>	If you do not need to adjust the gamma settings, select <b>Mode 4</b> .
	<b>Color Temp</b>	<b>Custom</b>	The user can adjust it to red, green, or blue by customization.
		<b>Warm</b>	Sets the screen color to a reddish tone.
		<b>Medium</b>	Sets the screen color to between a red and blue tone.
		<b>Cool</b>	Sets the screen color to a bluish tone.
		<b>Manual</b>	The user can fine - tune the color temperature.
	<b>R/G/B</b>	You can customize the picture color using <b>Red, Green, and Blue</b> colors.	
	<b>Six Color</b>	Meets the user requirements for colors by adjusting the hue and saturation of the six colors and then saving the settings.	
		<b>Hue</b>	Adjusts the tone of the screen colors.
		<b>Saturation</b>	Adjusts the saturation of the screen colors. The lower the value, the less saturated and brighter the colors become. The higher the value, the more saturated and darker the colors become.
	<b>Black Level</b>	Sets the offset level (for HDMI only). • Offset: as a reference for a video signal, this is the darkest color the monitor can display.	
<b>High</b>		Keeps the current contrast ratio of the screen.	
<b>Low</b>		Lowers the black levels and raises the white levels from the current contrast ratio of the screen.	

<b>Picture Adjust</b>	<b>DFC</b>	<b>On</b>	Adjusts the brightness automatically according to the screen.
		<b>Off</b>	Disables the <b>DFC</b> feature.
	<b>Picture Reset</b>	Do you want to reset your picture settings?	
		<b>No</b>	Cancel the select.
		<b>Yes</b>	Returns to the default settings.

Menu > Input		Description	
Input	<b>Input List</b>	Selects the input mode.	
	<b>Aspect Ratio</b>	Adjusts the aspect ratio of the screen.	
		<b>Full Wide</b>	Displays the video in widescreen, regardless of the video signal input.
		<b>Original</b>	Displays video according to the aspect ratio of the video signal input.
	 <b>NOTE</b> <ul style="list-style-type: none"> <li>The display may look the same for <b>Full Wide</b> and <b>Original</b> options at the recommended resolution. (1920 x 1080)</li> </ul>		
	<b>Auto Input Switch</b>	When automatic input switch is set to <b>On</b> , display will automatically switch to new input when connected.	
		<b>On</b>	Enables <b>Auto Input Switch</b> .
		<b>Off</b>	Disables <b>Auto Input Switch</b> .

Menu > General		Description		
General	Language	Sets the menu screen to the desired language.		
	SMART ENERGY SAVING	High	Saves energy using the high-efficiency SMART ENERGY SAVING feature.	
		Low	Saves energy using the low-efficiency SMART ENERGY SAVING feature.	
		Off	Disables the SMART ENERGY SAVING feature.	
		 <b>NOTE</b> <ul style="list-style-type: none"> <li>The value of energy saving data may differ depending on panel and panel suppliers.</li> <li>If you select the option of <b>SMART ENERGY SAVING</b> is <b>High</b> or <b>Low</b>, monitor luminance become lower or higher depend on source.</li> </ul>		
	Power LED	On	The power LED turns on automatically.	
		Off	The power LED turns off.	
	Automatic Standby	Feature that automatically turns off the monitor when there is no movement on the screen for a period of time. You can set a timer for the auto-off function. ( <b>8H</b> , <b>6H</b> , <b>4H</b> and <b>Off</b> )		
	HDMI Compatibility Mode	HDMI Compatibility Mode feature can recognize the legacy equipment that does not support HDMI 2.0.		
		On	Enables <b>HDMI Compatibility Mode</b> .	
		Off	Disables <b>HDMI Compatibility Mode</b> .	
 <b>NOTE</b> <ul style="list-style-type: none"> <li>If the connected device does not support <b>HDMI Compatibility Mode</b>, the screen or sound may not work properly.</li> <li>Some older graphics cards do not support HDMI 2.0, but you can select HDMI 2.0 resolution in the control panel of window.</li> <li>This may cause the screen to appear abnormally.</li> </ul>				
DisplayPort Version	Please set the DisplayPort version to match the version of the connected external device (1.4, 1.2 and 1.1). If you want to use the HDR, select the DP version to 1.4 .			

General	Buzzer	This feature lets you set the sound generated from Buzzer when your monitor powers on.	
		On	Enables your monitor's <b>Buzzer</b> .
		Off	Disables your monitor's <b>Buzzer</b> .
	OSD Lock	This feature disables the configuration and adjustment of menus.	
		On	Enables <b>OSD Lock</b> .
		Off	Disables <b>OSD Lock</b> .
		 <b>NOTE</b> <ul style="list-style-type: none"> <li>All features are disabled except <b>Brightness, Contrast</b> in <b>Picture Adjust, Input, OSD Lock</b> and <b>Information</b> in <b>General</b>.</li> </ul>	
	Information	The display information will be shown the <b>Total Power On Time, Resolution</b> .	
	Reset to Initial Settings	Do you want to reset your settings?	
		No	Cancel the select.
		Yes	Returns to the default settings.

## TROUBLESHOOTING

Nothing is displayed on the screen.	
Is the monitor's power cord plugged in?	<ul style="list-style-type: none"> <li>• Check if the power cord is correctly plugged into the power outlet.</li> </ul>
Is the power LED on?	<ul style="list-style-type: none"> <li>• Check the power cable connection and press the power button.</li> </ul>
Is the power on and the power LED displaying white?	<ul style="list-style-type: none"> <li>• Check that the connected input is enabled (<b>Menu &gt; Input</b>).</li> </ul>
Is the power LED blinking?	<ul style="list-style-type: none"> <li>• If the monitor is in sleep mode, move the mouse, or press any key on the keyboard, to switch the display on.</li> <li>• Check if the computer is turned on.</li> </ul>
Is the <b>The screen is not currently set to the recommended resolution. If you have no video or the screen flickers, see the troubleshooting guide in the product owner's manual.</b> message being displayed?	<ul style="list-style-type: none"> <li>• This occurs when signals transferred from the PC (graphics card) are out of the recommended horizontal or vertical frequency range of the monitor. Please see the Product Specification section of this manual to set the appropriate frequency.</li> </ul>
Is the <b>No Signal</b> message being displayed?	<ul style="list-style-type: none"> <li>• This is displayed when the signal cable between the PC and the monitor is missing or disconnected. Check the cable and reconnect it.</li> </ul>
Have you installed the display driver?	<ul style="list-style-type: none"> <li>• Be sure to install the display driver from our web site: <a href="http://www.lg.com">http://www.lg.com</a>.</li> <li>• Make sure to check if the graphics card supports Plug and Play function.</li> </ul>

Some features are disabled.	
Are some functions not available when you press the Menu button?	<ul style="list-style-type: none"> <li>• The OSD is locked. Go to <b>Menu &gt; General</b> and set <b>OSD Lock</b> to <b>Off</b>.</li> </ul>



<b>The screen retains an image.</b>	
Does image sticking occur even when the monitor is turned off?	<ul style="list-style-type: none"> <li>• Displaying a still image for a prolonged time may cause damage to the screen, resulting in the retention of the image.</li> <li>• To extend the lifetime of the monitor, use a screensaver.</li> </ul>

<b>Screen display is unstable and shaky. / Images displayed on the monitor leave shadow trails.</b>	
Did you select the appropriate resolution?	<ul style="list-style-type: none"> <li>• If the selected resolution is HDMI 1080i 60/50 Hz (interlaced), the screen may be flickering. Change the resolution to 1080p or the recommended resolution.</li> </ul>

## NOTE

- Vertical Frequency: In order to display an image, the screen must be refreshed dozens of times per second, like a fluorescent lamp. The number of times the screen is refreshed per second is called vertical frequency, or refresh rate, and is represented by Hz.
- Horizontal Frequency: The time it takes to display one horizontal line is called the horizontal cycle. If 1 is divided by the horizontal interval, the result is the number of horizontal lines displayed per second. This is called horizontal frequency and is represented by kHz.
- Check if the graphics card's resolution or frequency is within the range allowed by the monitor and set it to the recommended (optimal) resolution **Control Panel > Display > Menu** in Windows. (The settings may differ depending on the operating system (OS) you use.)
- Not setting the graphics card to the recommended (optimal) resolution may result in blurred text, a dimmed screen, a truncated display area or misalignment of the display.
- The setting methods may be different depending on the computer or operating system, and some resolutions may not be available depending on the performance of the graphics card. If this is the case, contact the manufacturer of the computer or graphics card for assistance.
- Some graphics cards may not support 1920 x 1080 resolution. If the resolution cannot be displayed, contact the manufacturer of your graphics card.

<b>The display color is abnormal.</b>	
Does the display appear discolored (16 colors)?	<ul style="list-style-type: none"> <li>Set the color to 24 bit (true color) or higher. In Windows, go to <b>Control Panel &gt; Display &gt; Menu &gt; Color Quality</b>. (The settings may differ depending on the operating system (OS) you use.)</li> </ul>
Does the display color appear unstable or monochrome?	<ul style="list-style-type: none"> <li>Check if the signal cable is connected properly. Reconnect the cable or reinsert the PC's graphics card.</li> </ul>
Are there spots on the screen?	<ul style="list-style-type: none"> <li>When using the monitor, pixilated spots (red, green, blue, white, or black) may appear on the screen. This is normal for an LCD screen. It is not an error, nor is it related to the monitor's performance.</li> </ul>

<b>No sound from the headphone port.</b>	
Are images displayed using DP (DisplayPort) or HDMI input without sound?	<ul style="list-style-type: none"> <li>Make sure that the headphone port connections are made properly.</li> <li>Try increasing the volume with the joystick.</li> <li>Set the audio output of the PC to the monitor you are using. On Microsoft Windows, go to <b>Control Panel &gt; Hardware and Sound &gt; Sound &gt; set the Monitor as default device</b>. (The settings may differ depending on the operating system (OS) you use.)</li> </ul>

# PRODUCT SPECIFICATION

## 24GN600 24GN600P 24GN60T 24GN60TP

LCD Screen	Color Depth	8-bit / 10-bit color is supported.
Resolution	Max Resolution	1920 x 1080 @ 144 Hz
	Recommended Resolution	1920 x 1080 @ 144 Hz
Power Sources	Power Rating	19 V --- 2.0 A
	Power Consumption (Typical)	On mode: 32 W Typ. (Outgoing condition)* Sleep Mode (Standby Mode): ≤ 0.5 W ** Off Mode: ≤ 0.3 W
AC/DC Adapter	<p>ADS-45SN-19-3 19040G type, manufactured by SHENZHEN HONOR ELECTRONIC  Or ADS-45SQ-19-3 19040E type, manufactured by SHENZHEN HONOR ELECTRONIC  Or ADS-45FSQ-19 19040EPG-1 type, manufactured by SHENZHEN HONOR ELECTRONIC  Or ADS-45FSQ-19 19040EPK-1 type, manufactured by SHENZHEN HONOR ELECTRONIC  Or ADS-45FSQ-19 19040EPCU-1 type, manufactured by SHENZHEN HONOR ELECTRONIC  Or ADS-45FSQ-19 19040EPBR-1 type, manufactured by SHENZHEN HONOR ELECTRONIC  Or LCAP21C type, manufactured by LIEN CHANG ELECTRONIC ENTERPRISE  Or LCAP26B-E type, manufactured by LIEN CHANG ELECTRONIC ENTERPRISE  Or LCAP26B-A type, manufactured by LIEN CHANG ELECTRONIC ENTERPRISE  Or AD10530LF type, manufactured by PI Electronics (H.K.) Ltd.  Or AD2137S20 type, manufactured by PI Electronics (H.K.) Ltd.  Or AD2137620 type, manufactured by PI Electronics (H.K.) Ltd.  Output: 19 V --- 2.1 A</p>	

Environmental Conditions	Operating Conditions	Temperature	0 °C to 40 °C (32 °F to 104 °F)
		Humidity	Less than 80 %
	Storing Conditions	Temperature	-20 °C to 60 °C (-4 °F to 140 °F)
		Humidity	Less than 85 %
Dimensions	Monitor Size (Width x Height x Depth)		
	With Stand	540.8 x 408.9 x 180.5 (mm) 21.2 x 16 x 7.1 (inches)	
	Without Stand	540.8 x 323.8 x 42.8 (mm) 21.2 x 12.7 x 1.6 (inches)	
Weight (Without Packaging)	With Stand	4.0 kg (8.8 lbs)	
	Without Stand	3.5 kg (7.7 lbs)	

Specifications are subject to change without notice.

The ~ symbol means alternating current, and the --- symbol means direct current.

The Power Consumption level can be different by operating condition and monitor setting.

\* The On mode power consumption is measured with LGE test standard (Full White pattern , Maximum resolution).

\*\* The monitor goes to the Sleep Mode in a couple of minutes(Max 5 minutes).

# PRODUCT SPECIFICATION

## 27GN600 27GN600P

LCD Screen	Color Depth	8-bit / 10-bit color is supported.
Resolution	Max Resolution	1920 x 1080 @ 144 Hz
	Recommended Resolution	1920 x 1080 @ 144 Hz
Power Sources	Power Rating	19 V --- 2.4 A Or 19 V --- 2.0 A
	Power Consumption (Typical)	On mode: 43 W Typ. (Outgoing condition)* Sleep Mode (Standby Mode): ≤ 0.5 W ** Off Mode: ≤ 0.3 W
AC/DC Adapter	DA-48F19 type, manufactured by Asian Power Devices Inc. Or ADS-48FSK-19 19048EPCU-1 type, manufactured by SHENZHEN HONOR ELECTRONIC Or ADS-48FSK-19 19048EPK-1 type, manufactured by SHENZHEN HONOR ELECTRONIC Or ADS-48FSK-19 19048EPG-1 type, manufactured by SHENZHEN HONOR ELECTRONIC Or MS-Z2530R190-048M0-E type, manufactured by MOSO POWER SUPPLY TECHNOLOGY CO LTD Or MS-V2530R190-048L0-DE type, manufactured by MOSO POWER SUPPLY TECHNOLOGY CO LTD Or MS-V2530R190-048L0-KR type, manufactured by MOSO POWER SUPPLY TECHNOLOGY CO LTD Or MS-V2530R190-048L0-US type, manufactured by MOSO POWER SUPPLY TECHNOLOGY CO LTD Output: 19 V --- 2.53 A	
	ADS-45SN-19-3 19040G type, manufactured by SHENZHEN HONOR ELECTRONIC Or ADS-45SQ-19-3 19040E type, manufactured by SHENZHEN HONOR ELECTRONIC Or ADS-45FSQ-19 19040EPG-1 type, manufactured by SHENZHEN HONOR ELECTRONIC Or ADS-45FSQ-19 19040EPK-1 type, manufactured by SHENZHEN HONOR ELECTRONIC Or ADS-45FSQ-19 19040EPCU-1 type, manufactured by SHENZHEN HONOR ELECTRONIC Or ADS-45FSQ-19 19040EPBR-1 type, manufactured by SHENZHEN HONOR ELECTRONIC Or AD10530LF type, manufactured by PI Electronics (H.K.) Ltd. Or AD2137S20 type, manufactured by PI Electronics (H.K.) Ltd. Or AD2137620 type, manufactured by PI Electronics (H.K.) Ltd. Output: 19 V --- 2.1 A	

Environmental Conditions	Operating Conditions	Temperature	0 °C to 40 °C (32 °F to 104 °F)
		Humidity	Less than 80 %
	Storing Conditions	Temperature	-20 °C to 60 °C (-4 °F to 140 °F)
		Humidity	Less than 85 %
Dimensions	Monitor Size (Width x Height x Depth)		
	With Stand	614.2 x 454.2 x 224.8 (mm) 24.1 x 17.8 x 8.8 (inches)	
	Without Stand	614.2 x 364.8 x 51.7 (mm) 24.1 x 14.3 x 2.0 (inches)	
Weight (Without Packaging)	With Stand	5.8 kg (12.7 lbs)	
	Without Stand	5.1 kg (11.2 lbs)	

Specifications are subject to change without notice.

The ~ symbol means alternating current, and the --- symbol means direct current.

The Power Consumption level can be different by operating condition and monitor setting.

\* The On mode power consumption is measured with LGE test standard (Full White pattern , Maximum resolution).

\*\* The monitor goes to the Sleep Mode in a couple of minutes(Max 5 minutes).

# PRODUCT SPECIFICATION

## 32GN600 32GK60W

LCD Screen	Color Depth	8-bit / 10-bit color is supported.
Resolution	Max Resolution	2560 x 1440 @ 144 Hz (HDMI) 2560 x 1440 @ 165 Hz (DP)
	Recommended Resolution	2560 x 1440 @ 120 Hz
Power Sources	Power Rating	19 V --- 3.3 A
	Power Consumption (Typical)	On mode: 60 W Typ. (Outgoing condition)* Sleep Mode (Standby Mode): ≤ 0.5 W ** Off Mode: ≤ 0.3 W
AC/DC Adapter	DA-65G19 type, manufactured by Asian Power Devices Inc. Or LCAP39 type, manufactured by LIEN CHANG ELECTRONIC ENTERPRISE Or ADS-65FAI-19 19065EPG-1 type, manufactured by SHENZHEN HONOR ELECTRONIC Or ADS-65FAI-19 19065EPK-1 type, manufactured by SHENZHEN HONOR ELECTRONIC Or ADS-65FAI-19 19065EPCU-1 type, manufactured by SHENZHEN HONOR ELECTRONIC Or ADS-65AI-19-3 19065E type, manufactured by SHENZHEN HONOR ELECTRONIC Or MS-V3420R190-065L0-DE type, manufactured by MOSO POWER Supply Technology CO LTD Or MS-V3420R190-065L0-KR type, manufactured by MOSO POWER Supply Technology CO LTD Or MS-V3420R190-065L0-US type, manufactured by MOSO POWER Supply Technology CO LTD Output: 19 V --- 3.42 A	

Environmental Conditions	Operating Conditions	Temperature	0 °C to 40 °C (32 °F to 104 °F)
		Humidity	Less than 80 %
	Storing Conditions	Temperature	-20 °C to 60 °C (-4 °F to 140 °F)
		Humidity	Less than 85 %
Dimensions	Monitor Size (Width x Height x Depth)		
	With Stand	714.7 x 515.1 x 224.8 (mm) 28.1 x 20.2 x 8.8 (inches)	
	Without Stand	714.7 x 428 x 77.5 (mm) 28.1 x 16.8 x 3.0 (inches)	
Weight (Without Packaging)	With Stand	5.9 kg (12.9 lbs)	
	Without Stand	5.2 kg (11.4 lbs)	

Specifications are subject to change without notice.

The ~ symbol means alternating current, and the --- symbol means direct current.

The Power Consumption level can be different by operating condition and monitor setting.

\* The On mode power consumption is measured with LGE test standard (Full White pattern , Maximum resolution).

\*\* The monitor goes to the Sleep Mode in a couple of minutes(Max 5 minutes).



## Factory Support Mode

(Preset Mode, HDMI/ DisplayPort PC)

24GN600 24GN600P 24GN60T 24GN60TP

Preset Mode	Horizontal Frequency (kHz)	Vertical Frequency (Hz)	Polarity (H/V)	Remarks
640 x 480	31.469	59.94	-/-	
800 x 600	76.302	120	+/-	
800 x 600	37.879	60.317	+/+	
1024 x 768	97.551	120	+/-	
1024 x 768	48.363	60.0	-/-	
1280 x 720	45	60	+/+	DisplayPort
1920 x 1080	67.5	60	+/+	
1920 x 1080	84.36	74.99	+/+	
1920 x 1080	137.26	119.98 (120)	+/+	
1920 x 1080	168.46	143.98	+/-	

## 27GN600 27GN600P

Preset Mode	Horizontal Frequency (kHz)	Vertical Frequency (Hz)	Polarity (H/V)	Remarks
640 x 480	31.469	59.94	-/-	
1920 x 1080	67.5	60	+/+	
1920 x 1080	137.26	119.98	+/+	
1920 x 1080	168.46	143.98	+/+	

## 32GN600 32GK60W

Preset Mode	Horizontal Frequency (kHz)	Vertical Frequency (Hz)	Polarity (H/V)	Remarks
640 x 480	31.469	59.94	-/-	
800 x 600	37.879	60.317	+/+	
1024 x 768	48.363	60	-/-	
1920 x 1080	67.5	60	+/+	
2560 x 1440	88.79	59.95	+/-	
2560 x 1440	111.86	74.97	+/-	HDMI
2560 x 1440	183	120	+/+	
2560 x 1440	219.21	143.93	+/-	HDMI
2560 x 1440	222.15	143.97	+/-	DisplayPort
2560 x 1440	249.74	164.96	+/-	DisplayPort

If you use an input timing that is outside the supported frequency, you may experience poor response speed or image quality.

## HDMI Timing (Video)

24GN600 24GN600P 24GN60T 24GN60TP 32GN600 32GK60W

Preset Mode	Horizontal Frequency (kHz)	Vertical Frequency (Hz)	Remarks
480P	31.5	60	
720P	45	60	
1080P	67.5	60	
1080P	135	120	HDMI Compatibility Mode: Off
2160P	135	60	HDMI Compatibility Mode: Off

27GN600 27GN600P

Preset Mode	Horizontal Frequency (kHz)	Vertical Frequency (Hz)	Remarks
480P	31.5	60	
576P	31.25	50	
720P	37.5	50	
720P	45	60	
1080P	56.25	50	
1080P	67.5	60	
1080P	135	120	HDMI Compatibility Mode: Off
2160P	54	24	HDMI Compatibility Mode: Off
2160P	56.25	25	HDMI Compatibility Mode: Off
2160P	67.5	30	HDMI Compatibility Mode: Off
2160P	112.5	50	HDMI Compatibility Mode: Off
2160P	135	60	HDMI Compatibility Mode: Off

## Power LED

Mode	LED Color
On Mode	Red (For a few seconds)
Sleep Mode (Standby Mode)	Off
Off Mode	Off

## Beep Guide

### 24GN600/24GN600P

Menu	Location
Game Mode	1
Game Mode - Gamer1	1 1
Game Mode - Gamer2	1 2
Game Mode - FPS	1 3
Game Mode - RTS	1 4
Game Mode - Vivid	1 5
Game Mode - Reader	1 6
Game Mode - HDR Effect	1 7
Game Adjust	2
Game Adjust - Motion Blur Reduction	2 1
Game Adjust - Motion Blur Reduction - On	2 1 1
Game Adjust - Motion Blur Reduction - Off	2 1 2
Game Adjust - FreeSync Premium	2 2
Game Adjust - FreeSync Premium - Extended	2 2 1
Game Adjust - FreeSync Premium - Basic	2 2 2
Game Adjust - FreeSync Premium - Off	2 2 3
Game Adjust - Black Stabilizer	2 3
Game Adjust - Black Stabilizer	2 3 1 Slider
Game Adjust - Response Time	2 4
Game Adjust - Response Time - Faster	2 4 1

Menu	Location
Game Adjust - Response Time - Fast	2 4 2
Game Adjust - Response Time - Normal	2 4 3
Game Adjust - Response Time - Off	2 4 4
Game Adjust - Crosshair	2 5
Game Adjust - Crosshair - Red Cross	2 5 1
Game Adjust - Crosshair - Green Cross	2 5 2
Game Adjust - Crosshair - Red Dot	2 5 3
Game Adjust - Crosshair - Green Dot	2 5 4
Game Adjust - Crosshair - Off	2 5 5
Game Adjust - Game Reset	2 6
Game Adjust - Game Reset - No	2 6 1
Game Adjust - Game Reset - Yes	2 6 2
Picture Adjust	3
Picture Adjust - Brightness	3 1
Picture Adjust - Brightness	3 1 1 Slider
Picture Adjust - Contrast	3 2
Picture Adjust - Contrast	3 2 1 Slider
Picture Adjust - Sharpness	3 3
Picture Adjust - Sharpness	3 3 1 Slider
Picture Adjust - Gamma	3 4

Menu	Location
Picture Adjust - Gamma - Mode 1	3 4 1
Picture Adjust - Gamma - Mode 2	3 4 2
Picture Adjust - Gamma - Mode 3	3 4 3
Picture Adjust - Gamma - Mode 4	3 4 4
Picture Adjust - Color Temp	3 5
Picture Adjust - Color Temp - Custom	3 5 1
Picture Adjust - Color Temp - Warm	3 5 2
Picture Adjust - Color Temp - Medium	3 5 3
Picture Adjust - Color Temp - Cool	3 5 4
Picture Adjust - Color Temp - Manual	3 5 5
Picture Adjust - Color Temp - Manual	3 5 5 1 Slider
Picture Adjust - R/G/B	3 6
Picture Adjust - R/G/B - Red	3 6 1 Slider
Picture Adjust - R/G/B - Green	3 6 2 Slider
Picture Adjust - R/G/B - Blue	3 6 3 Slider
Picture Adjust - Six Color	3 7
Picture Adjust - Six Color - Red Hue	3 7 1 Slider
Picture Adjust - Six Color - Red Saturation	3 7 2 Slider

Menu	Location
Picture Adjust - Six Color - Green Hue	3 7 3 Slider
Picture Adjust - Six Color - Green Saturation	3 7 4 Slider
Picture Adjust - Six Color - Blue Hue	3 7 5 Slider
Picture Adjust - Six Color - Blue Saturation	3 7 6 Slider
Picture Adjust - Six Color - Cyan Hue	3 7 7 Slider
Picture Adjust - Six Color - Cyan Saturation	3 7 8 Slider
Picture Adjust - Six Color - Magenta Hue	3 7 9 Slider
Picture Adjust - Six Color - Magenta Saturation	3 7 10 Slider
Picture Adjust - Six Color - Yellow Hue	3 7 11 Slider
Picture Adjust - Six Color - Yellow Saturation	3 7 12 Slider
Picture Adjust - Black Level	3 8
Picture Adjust - Black Level - High	3 8 1
Picture Adjust - Black Level - Low	3 8 2
Picture Adjust - DFC	3 9
Picture Adjust - DFC - On	3 9 1
Picture Adjust - DFC - Off	3 9 2
Picture Adjust - Picture Reset	3 10
Picture Adjust - Picture Reset - No	3 10 1

Menu	Location
Picture Adjust - Picture Reset - Yes	3 10 2
Input	4
Input - Input List	4 1
Input - Input List - HDMI 1	4 1 1
Input - Input List - HDMI 2	4 1 2
Input - Input List - DisplayPort	4 1 3
Input - Aspect Ratio	4 2
Input - Aspect Ratio - Full Wide	4 2 1
Input - Aspect Ratio - Original	4 2 2
Input - Auto Input Switch	4 3
Input - Auto Input Switch - On	4 3 1
Input - Auto Input Switch - Off	4 3 2
General	5
General - Language	5 1
General - Language - English	5 1 1
General - Language - German	5 1 2
General - Language - French	5 1 3
General - Language - Spanish	5 1 4
General - Language - Italian	5 1 5
General - Language - Swedish	5 1 6
General - Language - Finnish	5 1 7
General - Language - Portuguese	5 1 8
General - Language - Portuguese (Brazil)	5 1 9
General - Language - Polish	5 1 10

Menu	Location
General - Language - Russian	5 1 11
General - Language - Greek	5 1 12
General - Language - Ukrainian	5 1 13
General - Language - Chinese	5 1 14
General - Language - Traditional Chinese	5 1 15
General - Language - Japanese	5 1 16
General - Language - Korean	5 1 17
General - SMART ENERGY SAVING	5 2
General - SMART ENERGY SAVING - High	5 2 1
General - SMART ENERGY SAVING - Low	5 2 2
General - SMART ENERGY SAVING - Off	5 2 3
General - Power LED	5 3
General - Power LED - On	5 3 1
General - Power LED - Off	5 3 2
General - Automatic Standby	5 4
General - Automatic Standby - 8H	5 4 1
General - Automatic Standby - 6H	5 4 2
General - Automatic Standby - 4H	5 4 3
General - Automatic Standby - Off	5 4 4
General - HDMI Compatibility Mode	5 5
General - HDMI Compatibility Mode - On	5 5 1
General - HDMI Compatibility Mode - Off	5 5 2
General - DisplayPort Version	5 6
General - DisplayPort Version - 1.4	5 6 1

<b>Menu</b>	<b>Location</b>
General - DisplayPort Version - 1.2	5 6 2
General - DisplayPort Version - 1.1	5 6 3
General - Buzzer	5 7
General - Buzzer - On	5 7 1
General - Buzzer - Off	5 7 2
General - OSD Lock	5 8
General - OSD Lock - On	5 8 1
General - OSD Lock - Off	5 8 2
General - Information	5 9
General - Reset to Initial Settings	5 10
General - Reset to Initial Settings - No	5 10 1
General - Reset to Initial Settings - Yes	5 10 2



## 27GN600/27GN600P

Menu	Location
Game Mode	1
Game Mode - Gamer1	1 1
Game Mode - Gamer2	1 2
Game Mode - FPS	1 3
Game Mode - RTS	1 4
Game Mode - Vivid	1 5
Game Mode - Reader	1 6
Game Mode - HDR Effect	1 7
Game Adjust	2
Game Adjust - Motion Blur Reduction	2 1
Game Adjust - Motion Blur Reduction - On	2 1 1
Game Adjust - Motion Blur Reduction - Off	2 1 2
Game Adjust - FreeSync Premium / Adaptive-Sync	2 2
Game Adjust - FreeSync Premium / Adaptive-Sync - Extended	2 2 1
Game Adjust - FreeSync Premium / Adaptive-Sync - Basic	2 2 2
Game Adjust - FreeSync Premium / Adaptive-Sync - Off	2 2 3
Game Adjust - Black Stabilizer	2 3
Game Adjust - Black Stabilizer	2 3 1 Slider
Game Adjust - Response Time	2 4
Game Adjust - Response Time - Faster	2 4 1

Menu	Location
Game Adjust - Response Time - Fast	2 4 2
Game Adjust - Response Time - Normal	2 4 3
Game Adjust - Response Time - Off	2 4 4
Game Adjust - Cross Hair	2 5
Game Adjust - Cross Hair - Red Cross	2 5 1
Game Adjust - Cross Hair - Green Cross	2 5 2
Game Adjust - Cross Hair - Red Dot	2 5 3
Game Adjust - Cross Hair - Green Dot	2 5 4
Game Adjust - Cross Hair - Off	2 5 5
Game Adjust - Game Reset	2 6
Game Adjust - Game Reset - No	2 6 1
Game Adjust - Game Reset - Yes	2 6 2
Picture Adjust	3
Picture Adjust - Brightness	3 1
Picture Adjust - Brightness	3 1 1 Slider
Picture Adjust - Contrast	3 2
Picture Adjust - Contrast	3 2 1 Slider
Picture Adjust - Sharpness	3 3
Picture Adjust - Sharpness	3 3 1 Slider
Picture Adjust - Gamma	3 4
Picture Adjust - Gamma - Mode 1	3 4 1
Picture Adjust - Gamma - Mode 2	3 4 2

Menu	Location
Picture Adjust - Gamma - Mode 3	3 4 3
Picture Adjust - Gamma - Mode 4	3 4 4
Picture Adjust - Color Temp	3 5
Picture Adjust - Color Temp - Custom	3 5 1
Picture Adjust - Color Temp - Warm	3 5 2
Picture Adjust - Color Temp - Medium	3 5 3
Picture Adjust - Color Temp - Cool	3 5 4
Picture Adjust - Color Temp - Manual	3 5 5
Picture Adjust - Color Temp - Manual	3 5 5 1 Slider
Picture Adjust - R/G/B	3 6
Picture Adjust - R/G/B - Red	3 6 1 Slider
Picture Adjust - R/G/B - Green	3 6 2 Slider
Picture Adjust - R/G/B - Blue	3 6 3 Slider
Picture Adjust - Six Color	3 7
Picture Adjust - Six Color - Red Hue	3 7 1 Slider
Picture Adjust - Six Color - Red Saturation	3 7 2 Slider
Picture Adjust - Six Color - Green Hue	3 7 3 Slider
Picture Adjust - Six Color - Green Saturation	3 7 4 Slider

Menu	Location
Picture Adjust - Six Color - Blue Hue	3 7 5 Slider
Picture Adjust - Six Color - Blue Saturation	3 7 6 Slider
Picture Adjust - Six Color - Cyan Hue	3 7 7 Slider
Picture Adjust - Six Color - Cyan Saturation	3 7 8 Slider
Picture Adjust - Six Color - Magenta Hue	3 7 9 Slider
Picture Adjust - Six Color - Magenta Saturation	3 7 10 Slider
Picture Adjust - Six Color - Yellow Hue	3 7 11 Slider
Picture Adjust - Six Color - Yellow Saturation	3 7 12 Slider
Picture Adjust - Black Level	3 8
Picture Adjust - Black Level - High	3 8 1
Picture Adjust - Black Level - Low	3 8 2
Picture Adjust - DFC	3 9
Picture Adjust - DFC - On	3 9 1
Picture Adjust - DFC - Off	3 9 2
Picture Adjust - Picture Reset	3 10
Picture Adjust - Picture Reset - No	3 10 1
Picture Adjust - Picture Reset - Yes	3 10 2
Input	4
Input - Input List	4 1

Menu	Location
Input - Input List - HDMI1	4 1 1
Input - Input List - HDMI2	4 1 2
Input - Input List - DisplayPort	4 1 3
Input - Aspect Ratio	4 2
Input - Aspect Ratio - Full Wide	4 2 1
Input - Aspect Ratio - Original	4 2 2
Input - Auto Input Switch	4 3
Input - Auto Input Switch - On	4 3 1
Input - Auto Input Switch - Off	4 3 2
General	5
General - Language	5 1
General - Language - English	5 1 1
General - Language - German	5 1 2
General - Language - French	5 1 3
General - Language - Spanish	5 1 4
General - Language - Italian	5 1 5
General - Language - Swedish	5 1 6
General - Language - Finnish	5 1 7
General - Language - Portuguese	5 1 8
General - Language - Portuguese (Brazil)	5 1 9
General - Language - Polish	5 1 10
General - Language - Russian	5 1 11
General - Language - Greek	5 1 12
General - Language - Ukrainian	5 1 13

Menu	Location
General - Language - Chinese	5 1 14
General - Language - Traditional Chinese	5 1 15
General - Language - Japanese	5 1 16
General - Language - Korean	5 1 17
General - SMART ENERGY SAVING	5 2
General - SMART ENERGY SAVING - High	5 2 1
General - SMART ENERGY SAVING - Low	5 2 2
General - SMART ENERGY SAVING - Off	5 2 3
General - Power LED	5 3
General - Power LED - On	5 3 1
General - Power LED - Off	5 3 2
General - Automatic Standby	5 4
General - Automatic Standby - 8H	5 4 1
General - Automatic Standby - 6H	5 4 2
General - Automatic Standby - 4H	5 4 3
General - Automatic Standby - Off	5 4 4
General - HDMI Compatibility Mode	5 5
General - HDMI Compatibility Mode - On	5 5 1
General - HDMI Compatibility Mode - Off	5 5 2
General - DisplayPort Version	5 6
General - DisplayPort Version - 1.4	5 6 1
General - DisplayPort Version - 1.2	5 6 2
General - DisplayPort Version - 1.1	5 6 3
General - Buzzer	5 7

<b>Menu</b>	<b>Location</b>
General - Buzzer - On	5 7 1
General - Buzzer - Off	5 7 2
General - OSD Lock	5 8
General - OSD Lock - On	5 8 1
General - OSD Lock - Off	5 8 2
General - Information	5 9
General - Reset to Initial Settings	5 10
General - Reset to Initial Settings - No	5 10 1
General - Reset to Initial Settings - Yes	5 10 2

## 32GN600

Menu	Location
Game Mode	1
Game Mode - Gamer1	1 1
Game Mode - Gamer2	1 2
Game Mode - FPS	1 3
Game Mode - RTS	1 4
Game Mode - Vivid	1 5
Game Mode - Reader	1 6
Game Mode - HDR Effect	1 7
Game Adjust	2
Game Adjust - Motion Blur Reduction	2 1
Game Adjust - Motion Blur Reduction - On	2 1 1
Game Adjust - Motion Blur Reduction - Off	2 1 2
Game Adjust - FreeSync Premium	2 2
Game Adjust - FreeSync Premium - On	2 2 1
Game Adjust - FreeSync Premium - Off	2 2 2
Game Adjust - Black Stabilizer	2 3
Game Adjust - Black Stabilizer	2 3 1 Slider
Game Adjust - Response Time	2 4
Game Adjust - Response Time - Faster	2 4 1
Game Adjust - Response Time - Fast	2 4 2
Game Adjust - Response Time - Normal	2 4 3
Game Adjust - Response Time - Off	2 4 4
Game Adjust - Crosshair	2 5

Menu	Location
Game Adjust - Crosshair - Red Cross	2 5 1
Game Adjust - Crosshair - Green Cross	2 5 2
Game Adjust - Crosshair - Red Dot	2 5 3
Game Adjust - Crosshair - Green Dot	2 5 4
Game Adjust - Crosshair - Off	2 5 5
Game Adjust - Game Reset	2 6
Game Adjust - Game Reset - No	2 6 1
Game Adjust - Game Reset - Yes	2 6 2
Picture Adjust	3
Picture Adjust - Brightness	3 1
Picture Adjust - Brightness	3 1 1 Slider
Picture Adjust - Contrast	3 2
Picture Adjust - Contrast	3 2 1 Slider
Picture Adjust - Sharpness	3 3
Picture Adjust - Sharpness	3 3 1 Slider
Picture Adjust - Gamma	3 4
Picture Adjust - Gamma - Mode 1	3 4 1
Picture Adjust - Gamma - Mode 2	3 4 2
Picture Adjust - Gamma - Mode 3	3 4 3
Picture Adjust - Gamma - Mode 4	3 4 4
Picture Adjust - Color Temp	3 5
Picture Adjust - Color Temp - Custom	3 5 1

Menu	Location
Picture Adjust - Color Temp - Warm	3 5 2
Picture Adjust - Color Temp - Medium	3 5 3
Picture Adjust - Color Temp - Cool	3 5 4
Picture Adjust - Color Temp - Manual	3 5 5
Picture Adjust - Color Temp - Manual	3 5 5 1 Slider
Picture Adjust - R/G/B	3 6
Picture Adjust - R/G/B - Red	3 6 1 Slider
Picture Adjust - R/G/B - Green	3 6 2 Slider
Picture Adjust - R/G/B - Blue	3 6 3 Slider
Picture Adjust - Six Color	3 7
Picture Adjust - Six Color - Red Hue	3 7 1 Slider
Picture Adjust - Six Color - Red Saturation	3 7 2 Slider
Picture Adjust - Six Color - Green Hue	3 7 3 Slider
Picture Adjust - Six Color - Green Saturation	3 7 4 Slider
Picture Adjust - Six Color - Blue Hue	3 7 5 Slider
Picture Adjust - Six Color - Blue Saturation	3 7 6 Slider
Picture Adjust - Six Color - Cyan Hue	3 7 7 Slider

Menu	Location
Picture Adjust - Six Color - Cyan Saturation	3 7 8 Slider
Picture Adjust - Six Color - Magenta Hue	3 7 9 Slider
Picture Adjust - Six Color - Magenta Saturation	3 7 10 Slider
Picture Adjust - Six Color - Yellow Hue	3 7 11 Slider
Picture Adjust - Six Color - Yellow Saturation	3 7 12 Slider
Picture Adjust - Black Level	3 8
Picture Adjust - Black Level - High	3 8 1
Picture Adjust - Black Level - Low	3 8 2
Picture Adjust - DFC	3 9
Picture Adjust - DFC - On	3 9 1
Picture Adjust - DFC - Off	3 9 2
Picture Adjust - Picture Reset	3 10
Picture Adjust - Picture Reset - No	3 10 1
Picture Adjust - Picture Reset - Yes	3 10 2
Input	4
Input - Input List	4 1
Input - Input List - HDMI 1	4 1 1
Input - Input List - HDMI 2	4 1 2
Input - Input List - DisplayPort	4 1 3
Input - Aspect Ratio	4 2
Input - Aspect Ratio - Full Wide	4 2 1

Menu	Location
Input - Aspect Ratio - Original	4 2 2
Input - Auto Input Switch	4 3
Input - Auto Input Switch - On	4 3 1
Input - Auto Input Switch - Off	4 3 2
General	5
General - Language	5 1
General - Language - English	5 1 1
General - Language - German	5 1 2
General - Language - French	5 1 3
General - Language - Spanish	5 1 4
General - Language - Italian	5 1 5
General - Language - Swedish	5 1 6
General - Language - Finnish	5 1 7
General - Language - Portuguese	5 1 8
General - Language - Portuguese (Brazil)	5 1 9
General - Language - Polish	5 1 10
General - Language - Russian	5 1 11
General - Language - Greek	5 1 12
General - Language - Ukrainian	5 1 13
General - Language - Chinese	5 1 14
General - Language - Traditional Chinese	5 1 15
General - Language - Japanese	5 1 16
General - Language - Korean	5 1 17
General - SMART ENERGY SAVING	5 2

Menu	Location
General - SMART ENERGY SAVING - High	5 2 1
General - SMART ENERGY SAVING - Low	5 2 2
General - SMART ENERGY SAVING - Off	5 2 3
General - Power LED	5 3
General - Power LED - On	5 3 1
General - Power LED - Off	5 3 2
General - Automatic Standby	5 4
General - Automatic Standby - 8H	5 4 1
General - Automatic Standby - 6H	5 4 2
General - Automatic Standby - 4H	5 4 3
General - Automatic Standby - Off	5 4 4
General - HDMI Compatibility Mode	5 5
General - HDMI Compatibility Mode - On	5 5 1
General - HDMI Compatibility Mode - Off	5 5 2
General - DisplayPort Version	5 6
General - DisplayPort Version - 1.4	5 6 1
General - DisplayPort Version - 1.2	5 6 2
General - DisplayPort Version - 1.1	5 6 3
General - Buzzer	5 7
General - Buzzer - On	5 7 1
General - Buzzer - Off	5 7 2
General - OSD Lock	5 8
General - OSD Lock - On	5 8 1
General - OSD Lock - Off	5 8 2

<b>Menu</b>	<b>Location</b>
General - Information	5 9
General - Reset to Initial Settings	5 10
General - Reset to Initial Settings - No	5 10 1
General - Reset to Initial Settings - Yes	5 10 2

## 32GK60W

Menu	Location
Game Mode	1
Game Mode - Gamer1	1 1
Game Mode - Gamer2	1 2
Game Mode - FPS	1 3
Game Mode - RTS	1 4
Game Mode - Vivid	1 5
Game Mode - Reader	1 6
Game Mode - HDR Effect	1 7
Game Adjust	2
Game Adjust - 1ms Motion Blur Reduction	2 1
Game Adjust - 1ms Motion Blur Reduction - On	2 1 1
Game Adjust - 1ms Motion Blur Reduction - Off	2 1 2
Game Adjust - FreeSync Premium	2 2
Game Adjust - FreeSync Premium - On	2 2 1
Game Adjust - FreeSync Premium - Off	2 2 2
Game Adjust - Black Stabilizer	2 3
Game Adjust - Black Stabilizer	2 3 1 Slider
Game Adjust - Response Time	2 4
Game Adjust - Response Time - Faster	2 4 1
Game Adjust - Response Time - Fast	2 4 2
Game Adjust - Response Time - Normal	2 4 3
Game Adjust - Response Time - Off	2 4 4

Menu	Location
Game Adjust - Cross Hair	2 5
Game Adjust - Cross Hair - Red Cross	2 5 1
Game Adjust - Cross Hair - Green Cross	2 5 2
Game Adjust - Cross Hair - Red Dot	2 5 3
Game Adjust - Cross Hair - Green Dot	2 5 4
Game Adjust - Cross Hair - Off	2 5 5
Game Adjust - Game Reset	2 6
Game Adjust - Game Reset - No	2 6 1
Game Adjust - Game Reset - Yes	2 6 2
Picture Adjust	3
Picture Adjust - Brightness	3 1
Picture Adjust - Brightness	3 1 1 Slider
Picture Adjust - Contrast	3 2
Picture Adjust - Contrast	3 2 1 Slider
Picture Adjust - Sharpness	3 3
Picture Adjust - Sharpness	3 3 1 Slider
Picture Adjust - Gamma	3 4
Picture Adjust - Gamma - Mode 1	3 4 1
Picture Adjust - Gamma - Mode 2	3 4 2
Picture Adjust - Gamma - Mode 3	3 4 3
Picture Adjust - Gamma - Mode 4	3 4 4
Picture Adjust - Color Temp	3 5

Menu	Location
Picture Adjust - Color Temp - Custom	3 5 1
Picture Adjust - Color Temp - Warm	3 5 2
Picture Adjust - Color Temp - Medium	3 5 3
Picture Adjust - Color Temp - Cool	3 5 4
Picture Adjust - Color Temp - Manual	3 5 5
Picture Adjust - Color Temp - Manual	3 5 5 1 Slider
Picture Adjust - R/G/B	3 6
Picture Adjust - R/G/B - Red	3 6 1 Slider
Picture Adjust - R/G/B - Green	3 6 2 Slider
Picture Adjust - R/G/B - Blue	3 6 3 Slider
Picture Adjust - Six Color	3 7
Picture Adjust - Six Color - Red Hue	3 7 1 Slider
Picture Adjust - Six Color - Red Saturation	3 7 2 Slider
Picture Adjust - Six Color - Green Hue	3 7 3 Slider
Picture Adjust - Six Color - Green Saturation	3 7 4 Slider
Picture Adjust - Six Color - Blue Hue	3 7 5 Slider
Picture Adjust - Six Color - Blue Saturation	3 7 6 Slider

Menu	Location
Picture Adjust - Six Color - Cyan Hue	3 7 7 Slider
Picture Adjust - Six Color - Cyan Saturation	3 7 8 Slider
Picture Adjust - Six Color - Magenta Hue	3 7 9 Slider
Picture Adjust - Six Color - Magenta Saturation	3 7 10 Slider
Picture Adjust - Six Color - Yellow Hue	3 7 11 Slider
Picture Adjust - Six Color - Yellow Saturation	3 7 12 Slider
Picture Adjust - Black Level	3 8
Picture Adjust - Black Level - High	3 8 1
Picture Adjust - Black Level - Low	3 8 2
Picture Adjust - DFC	3 9
Picture Adjust - DFC - On	3 9 1
Picture Adjust - DFC - Off	3 9 2
Picture Adjust - Picture Reset	3 10
Picture Adjust - Picture Reset - No	3 10 1
Picture Adjust - Picture Reset - Yes	3 10 2
Input	4
Input - Input List	4 1
Input - Input List - HDMI	4 1 1
Input - Input List - DisplayPort	4 1 2
Input - Aspect Ratio	4 2

Menu	Location
Input - Aspect Ratio - Full Wide	4 2 1
Input - Aspect Ratio - Original	4 2 2
Input - Auto Input Switch	4 3
Input - Auto Input Switch - On	4 3 1
Input - Auto Input Switch - Off	4 3 2
General	5
General - Language	5 1
General - Language - English	5 1 1
General - Language - German	5 1 2
General - Language - French	5 1 3
General - Language - Spanish	5 1 4
General - Language - Italian	5 1 5
General - Language - Swedish	5 1 6
General - Language - Finnish	5 1 7
General - Language - Portuguese	5 1 8
General - Language - Portuguese (Brazil)	5 1 9
General - Language - Polish	5 1 10
General - Language - Russian	5 1 11
General - Language - Greek	5 1 12
General - Language - Ukrainian	5 1 13
General - Language - Chinese	5 1 14
General - Language - Traditional Chinese	5 1 15
General - Language - Japanese	5 1 16
General - Language - Korean	5 1 17

Menu	Location
General - SMART ENERGY SAVING	5 2
General - SMART ENERGY SAVING - High	5 2 1
General - SMART ENERGY SAVING - Low	5 2 2
General - SMART ENERGY SAVING - Off	5 2 3
General - Power LED	5 3
General - Power LED - On	5 3 1
General - Power LED - Off	5 3 2
General - Automatic Standby	5 4
General - Automatic Standby - 8H	5 4 1
General - Automatic Standby - 6H	5 4 2
General - Automatic Standby - 4H	5 4 3
General - Automatic Standby - Off	5 4 4
General - HDMI Compatibility Mode	5 5
General - HDMI Compatibility Mode - On	5 5 1
General - HDMI Compatibility Mode - Off	5 5 2
General - DisplayPort Version	5 6
General - DisplayPort Version - 1.4	5 6 1
General - DisplayPort Version - 1.2	5 6 2
General - DisplayPort Version - 1.1	5 6 3
General - Buzzer	5 7
General - Buzzer - On	5 7 1
General - Buzzer - Off	5 7 2
General - OSD Lock	5 8
General - OSD Lock - On	5 8 1



<b>Menu</b>	<b>Location</b>
General - OSD Lock - Off	5 8 2
General - Information	5 9
General - Reset to Initial Settings	5 10
General - Reset to Initial Settings - No	5 10 1
General - Reset to Initial Settings - Yes	5 10 2

## LIMITED WARRANTY (USA)

THE PRODUCT'S FULL LIMITED WARRANTY TERMS AND CONDITIONS ARE AVAILABLE AT <https://www.lg.com/us> AND/OR YOUR WARRANTY.

**ARBITRATION NOTICE:** THIS LIMITED WARRANTY CONTAINS AN ARBITRATION PROVISION THAT REQUIRES YOU AND LG ELECTRONICS ("LG") TO RESOLVE DISPUTES BY BINDING ARBITRATION INSTEAD OF IN COURT, UNLESS YOU CHOOSE TO OPT OUT. IN ARBITRATION, CLASS ACTIONS AND JURY TRIALS ARE NOT PERMITTED. PLEASE SEE THE SECTION TITLED "PROCEDURE FOR RESOLVING DISPUTES" BELOW.

### PROCEDURE FOR RESOLVING DISPUTES:

ALL DISPUTES BETWEEN YOU AND LG ARISING OUT OF OR RELATING IN ANY WAY TO THIS LIMITED WARRANTY OR THE PRODUCT SHALL BE RESOLVED EXCLUSIVELY THROUGH BINDING ARBITRATION, AND NOT IN A COURT OF GENERAL JURISDICTION. BINDING ARBITRATION MEANS THAT YOU AND LG ARE EACH WAIVING THE RIGHT TO A JURY TRIAL AND TO BRING OR PARTICIPATE IN A CLASS ACTION.

**Definitions.** For the purposes of this section, references to "LG" mean LG Electronics U.S.A., Inc., its parents, subsidiaries and affiliates, and each of their officers, directors, employees, agents, beneficiaries, predecessors in interest, successors, assigns and suppliers; references to "dispute" or "claim" shall include any dispute, claim or controversy of any kind whatsoever (whether based in contract, tort, statute, regulation, ordinance, fraud, misrepresentation or any other legal or equitable theory) arising out of or relating in any way to the sale, condition or performance of the product or this Limited Warranty.

**Notice of Dispute.** In the event you intend to commence an arbitration proceeding, you must first notify LG in writing at least 30 days in advance of initiating the arbitration by sending a letter to LG at LG Electronics, USA, Inc. Attn: Legal Department- Arbitration 111 Sylvan Avenue, Englewood Cliffs, NJ 07632. You and LG agree to engage in good faith discussions in an attempt to amicably resolve your claim. The notice must provide your name, address, and telephone number; identify the product that is the subject of the claim; and describe the nature of the claim and the relief being sought. If you and LG are unable to resolve the dispute within 30 days, either party may proceed to file a claim for arbitration.

**Agreement to Binding Arbitration and Class Action Waiver.** Upon failure to resolve the dispute during the 30 day period after sending written notice to LG, you and LG agree to resolve any claims between us only by binding arbitration on an individual basis, unless you opt out as provided below. Any dispute between you and LG shall not be combined or consolidated with a dispute involving any other person's or entity's product or claim. More specifically, without limitation of the foregoing, any dispute between you and LG shall not under any circumstances proceed as part of a class or representative action. Instead of arbitration, either party may bring an individual action in small claims court, but that small claims court action may not be brought on a class or representative basis.

**Arbitration Rules and Procedures.** To begin arbitration of a claim, either you or LG must make a written demand for arbitration. The arbitration will be administered by the American Arbitration Association (“AAA”) and will be conducted before a single arbitrator under the AAA’s Consumer Arbitration Rules that are in effect at the time the arbitration is initiated (referred to as the “AAA Rules”) and under the procedures set forth in this section. The AAA Rules are available online at [www.adr.org/consumer](http://www.adr.org/consumer). Send a copy of your written demand for arbitration, as well as a copy of this provision, to the AAA in the manner described in the AAA Rules. You must also send a copy of your written demand to LG at LG Electronics, USA, Inc. Attn: Legal Department- Arbitration 111 Sylvan Avenue, Englewood Cliffs, NJ 07632. If there is a conflict between the AAA Rules and the rules set forth in this section, the rules set forth in this section will govern. This arbitration provision is governed by the Federal Arbitration Act. Judgment may be entered on the arbitrator’s award in any court of competent jurisdiction. All issues are for the arbitrator to decide, except that issues relating to the scope and enforceability of the arbitration provision and to the arbitrability of the dispute are for the court to decide. The arbitrator is bound by the terms of this provision.

**Governing Law.** The law of the state of your residence shall govern this Limited Warranty and any disputes between us except to the extent that such law is preempted by or inconsistent with applicable federal law.

**Fees/Costs.** You do not need to pay any fee to begin an arbitration. Upon receipt of your written demand for arbitration, LG will promptly pay all arbitration filing fees to the AAA unless you seek more than \$25,000 in damages, in which case the payment of these fees will be governed by the AAA Rules. Except as otherwise provided for herein, LG will pay all AAA filing, administration and arbitrator fees for any arbitration initiated in accordance with the AAA Rules and this arbitration provision. If you prevail in the arbitration, LG will pay your attorneys’ fees and expenses as long as they are reasonable, by considering factors including, but not limited to, the purchase amount and claim amount. Notwithstanding the foregoing, if applicable law allows for an award of reasonable attorneys’ fees and expenses, an arbitrator can award them to the same extent that a court would. If the arbitrator finds either the substance of your claim or the relief sought in the demand is frivolous or brought for an improper purpose (as measured by the standards set forth in Federal Rule of Civil Procedure 11(b)), then the payment of all arbitration fees will be governed by the AAA Rules. In such a situation, you agree to reimburse LG for all monies previously disbursed by it that are otherwise your obligation to pay under the AAA Rules. Except as otherwise provided for, LG waives any rights it may have to seek attorneys’ fees and expenses from you if LG prevails in the arbitration.

**Hearings and Location.** If your claim is for \$25,000 or less, you may choose to have the arbitration conducted solely on the basis of (1) documents submitted to the arbitrator, (2) through a telephonic hearing, or (3) by an in-person hearing as established by the AAA Rules. If your claim exceeds \$25,000, the right to a hearing will be determined by the AAA Rules. Any in-person arbitration hearings will be held at a location within the federal judicial district in which you reside unless we both agree to another location or we agree to a telephonic arbitration.

**Opt Out.** You may opt out of this dispute resolution procedure. If you opt out, neither you nor LG can require the other to participate in an arbitration proceeding. To opt out, you must send notice to LG no later than 30 calendar days from the date of the first consumer purchaser’s purchase of the product by either: (i) sending an e-mail to [optout@lge.com](mailto:optout@lge.com), with the subject line: “Arbitration Opt Out” or (ii) calling 1- 800-980-2973. You must include in the opt out e-mail or provide by telephone: (a) your name and address; (b) the date on which the product was purchased; (c) the product model name or model number; and (d) the serial number (the serial number can be found (i) on the product; or (ii) online by accessing <https://www.lg.com/us/support> and clicking on “How do I find my model number?”).

You may only opt out of the dispute resolution procedure in the manner described above (that is, by e-mail or telephone); no other form of notice will be effective to opt out of this dispute resolution procedure.

Opting out of this dispute resolution procedure will not affect the coverage of the Limited Warranty in any way, and you will continue to enjoy the full benefits of the Limited Warranty. If you keep this product and do not opt out, then you accept all terms and conditions of the arbitration provision described above.

# LIMITED WARRANTY (CANADA)

THE PRODUCT'S FULL LIMITED WARRANTY TERMS AND CONDITIONS ARE AVAILABLE AT [https://www.lg.com/ca\\_en/](https://www.lg.com/ca_en/) AND/OR YOUR WARRANTY.

**ARBITRATION NOTICE:** THIS LIMITED WARRANTY CONTAINS AN ARBITRATION PROVISION THAT REQUIRES YOU AND LG TO RESOLVE DISPUTES BY BINDING ARBITRATION INSTEAD OF IN COURT, UNLESS THE LAWS OF YOUR PROVINCE OR TERRITORY DO NOT PERMIT THAT, OR, IN OTHER JURISDICTIONS, IF YOU CHOOSE TO OPT OUT. FOR FURTHER CLARITY, THIS ARBITRATION PROVISION IS NOT APPLICABLE TO CONSUMERS RESIDING IN ONTARIO AND QUÉBEC. IN ARBITRATION, CLASS ACTIONS AND JURY TRIALS ARE NOT PERMITTED. PLEASE SEE THE SECTION TITLED "PROCEDURE FOR RESOLVING DISPUTES" BELOW.

• **DISCLAIMER:**

IF YOU ARE A CONSUMER SUBJECT TO QUÉBEC AND ONTARIO'S CONSUMER PROTECTION ACT, THE EXCLUSION OF WARRANTIES CONTAINED IN THIS SECTION DO NOT EXCLUDE OR LIMIT THE RIGHTS AND REMEDIES THAT YOU MAY HAVE UNDER SUCH ACT, INCLUDING THE RIGHT TO MAKE A CLAIM UNDER ANY OF THE STATUTORY WARRANTIES PROVIDED THEREUNDER.

**PROCEDURE FOR RESOLVING DISPUTES:**

EXCEPT WHERE PROHIBITED AT LAW (INCLUDING WITH RESPECT TO QUÉBEC AND ONTARIO CONSUMERS), ALL DISPUTES BETWEEN YOU AND LG ARISING OUT OF OR RELATING IN ANY WAY TO THIS LIMITED WARRANTY OR THE PRODUCT SHALL BE RESOLVED EXCLUSIVELY THROUGH BINDING ARBITRATION, AND NOT IN A COURT OF GENERAL JURISDICTION. EXCEPT WHERE PROHIBITED AT LAW (INCLUDING WITH RESPECT TO QUÉBEC AND ONTARIO CONSUMERS), YOU AND LG BOTH IRREVOCABLY AGREE TO WAIVE THE RIGHT TO A JURY TRIAL AND TO BRING OR PARTICIPATE IN A CLASS ACTION.

**Definitions.** For the purposes of this section, references to "LG" mean LG Electronics Canada, Inc., its parents, subsidiaries and affiliates, and each of their officers, directors, employees, agents, beneficiaries, predecessors in interest, successors, assigns and suppliers; references to "dispute" or "claim" shall include any dispute, claim or controversy of any kind whatsoever (whether based in contract, tort, statute, regulation, ordinance, fraud, misrepresentation or any other legal or equitable theory) arising out of or relating in any way to the sale, condition or performance of the product or this Limited Warranty.

**Notice of Dispute.** In the event you intend to commence an arbitration proceeding, you must first notify LG in writing at least 30 days in advance of initiating the arbitration by sending a letter to LGECI Legal Team at 20 Norelco Drive, North York, Ontario, Canada M9L 2X6 (the "Notice of Dispute"). You and LG agree to engage in good faith discussions in an attempt to amicably resolve your claim. The notice must provide your name, address, and telephone number; identify the product that is the subject of the claim; and describe the nature of the claim and the relief being sought. If you and LG are unable to resolve the dispute within 30 days of LG's receipt of the Notice of Dispute, the dispute shall be resolved by binding arbitration in accordance with the procedure set out herein. You and LG both agree that, during the arbitration proceeding, the terms (including any amount) of any settlement offer made by either you or LG will not be disclosed to the arbitrator until the arbitrator determines the dispute.

**Agreement to Binding Arbitration and Class Action Waiver.** Upon failure to resolve the dispute during the 30 day period after LG's receipt of the Notice of Dispute, you and LG agree to resolve any claims between you and LG only by binding arbitration on an individual basis, unless you opt out as provided below, or you reside in a jurisdiction that prevents full application of this clause in the circumstances of the claims at issue (in which case if you are a consumer, this clause will only apply if you expressly agree to the arbitration). To the extent permitted by applicable law, any dispute between you and LG shall not be combined or consolidated with a dispute involving any other person's or entity's product or claim. More specifically, without limitation of the foregoing, except to the extent such a prohibition is not permitted at law, any dispute between you and LG shall not under any circumstances proceed as part of a class or representative action. Instead of arbitration, either party may bring an individual action in small claims court, but that small claims court action may not be brought on a class or representative basis except to the extent this prohibition is not permitted at law in your province or territory of jurisdiction as it relates to the claims at issue between you and LG. This does not apply to consumers in Ontario and Québec. In accordance with provincial legislation, the consumer and LG may agree to resolve the dispute using any procedure available, including commencing the action before the competent courts of those provinces.

**Arbitration Rules and Procedures.** To begin arbitration of a claim, either you or LG must make a written demand for arbitration. The arbitration will be private and confidential, and conducted on a simplified and expedited basis before a single arbitrator chosen by the parties under the provincial or territorial commercial arbitration law and rules of the province or territory of your residence. You must also send a copy of your written demand to LG at LG Electronics, Canada, Inc., Attn: Legal Department- Arbitration, 20 Norelco Drive, North York, Ontario M9L 2X6. This arbitration provision is governed by your applicable provincial or territorial commercial arbitration legislation. For consumers in Ontario and Québec, the applicable arbitration legislation only applies if consumers agree to submit the dispute to arbitration. Judgment may be entered on the arbitrator's award in any court of competent jurisdiction. All issues are for the arbitrator to decide, except that, issues relating to the scope and enforceability of the arbitration provision and to the arbitrability of the dispute are for the court to decide. The arbitrator is bound by the terms of this provision.

**Governing Law.** The law of the province or territory of your purchase shall govern this Limited Warranty and any disputes between you and LG except to the extent that such law is preempted by or inconsistent with applicable federal or provincial/territorial law. Should arbitration not be permitted for any claim, action, dispute or controversy between you and LG, you and LG attend to the exclusive jurisdiction of the courts of the province or territory of your purchase for the resolution of the claim, action, dispute or controversy between you and LG.

**Fees/Costs.** You do not need to pay any fee to begin an arbitration. Upon receipt of your written demand for arbitration, LG will promptly pay all arbitration filing fees unless you seek more than \$25,000 in damages, in which case the payment of these fees will be governed by the applicable arbitration rules. Except as otherwise provided for herein, LG will pay all filing, administration and arbitrator fees for any arbitration initiated in accordance with the applicable arbitration rules and this arbitration provision. If you prevail in the arbitration, LG will pay your attorneys' fees and expenses as long as they are reasonable, by considering factors including, but not limited to, the purchase amount and claim amount. Notwithstanding the foregoing, if applicable law allows for an award of reasonable attorneys' fees and expenses, an arbitrator can award them to the same extent that a court would. If the arbitrator finds either the substance of your claim or the relief sought in the demand is frivolous or brought for an improper purpose (as measured by the applicable laws), then the payment of all arbitration fees will be governed by the applicable arbitration rules. In such a situation, you agree to reimburse LG for all monies previously disbursed by it that are otherwise your obligation to pay under the applicable arbitration rules. Except as otherwise provided for, LG waives any rights it may have to seek attorneys' fees and expenses from you if LG prevails in the arbitration.

**Hearings and Location.** If your claim is for \$25,000 or less, you may choose to have the arbitration conducted solely (1) on the basis of documents submitted to the arbitrator, (2) through a telephonic hearing, or (3) by an in-person hearing as established by the applicable arbitration rules. If your claim exceeds \$25,000, the right to a hearing will be determined by the applicable arbitration rules. Any in-person arbitration hearings will be held at the nearest, most mutually-convenient arbitration location available within the province or territory in which you reside unless you and LG both agree to another location or agree to a telephonic arbitration.

**Severability and Waiver.** If any portion of this Limited Warranty (including these arbitration procedures) is unenforceable, the remaining provisions will continue in full force and effect to the maximum extent permitted by applicable law. Should LG fail to enforce strict performance of any provision of this Limited Warranty (including these arbitration procedures), it does not mean that LG intends to waive or has waived any provision or part of this Limited Warranty.

**Opt Out.** The arbitration provision requires you and LG to resolve disputes by binding arbitration instead of court, unless the laws of your province or territory do not permit that, or, in other jurisdictions, if you choose to opt out. The arbitration provision does not apply to consumers in Ontario and Québec.

For individuals that fall within the binding arbitration provisions, you may opt out of this dispute resolution procedure. If you opt out, neither you nor LG can require the other to participate in an arbitration proceeding. To opt out, you must send notice to LG no later than 30 calendar days from the date of the first consumer purchaser's purchase of the product by either (i) sending an e-mail to [optout@lge.com](mailto:optout@lge.com), with the subject line: "Arbitration Opt Out;" or (ii) calling 1-800-980-2973. You must include in the opt out e-mail or provide by telephone: (a) your name and address; (b) the date on which the product was purchased; (c) the product model name or model number, and (d) the serial number (the serial number can be found (i) on the product; or (ii) online by accessing [https://www.lg.com/ca\\_en/findmodel\\_serial/](https://www.lg.com/ca_en/findmodel_serial/)).

In the event that you "Opt Out," the law of the province or territory of your residence shall govern this Limited Warranty and any disputes between you and LG except to the extent that such law is preempted by or inconsistent with applicable federal or provincial/territorial law. Should arbitration not be permitted for any claim, action, dispute or controversy between you and LG, you and LG agree to attorn to the exclusive jurisdiction of the courts of the province or territory of your residence for the resolution of the claim, action, dispute or controversy between you and LG.

You may only opt out of the dispute resolution procedure in the manner described above (that is, by e-mail or telephone); no other form of notice will be effective to opt out of this dispute resolution procedure. Opting out of this dispute resolution procedure will not affect the coverage of the Limited Warranty in any way, and you will continue to enjoy the full benefits of the Limited Warranty. If you keep this product and do not opt out, then you accept all terms and conditions of the arbitration provision described above.

**Conflict of Terms.** In the event of a conflict or inconsistency between the terms of this Limited Warranty and the End User License Agreement ("EULA") in regards to dispute resolution, the terms of this Limited Warranty shall control and govern the rights and obligations of the parties and shall take precedence over the EULA.



**Supplier's Declaration of Conformity**

Trade Name	LG
Responsible Party	LG Electronics USA, Inc.
Address	111 Sylvan Avenue, North Building, Englewood Cliffs, NJ 07632
E-mail	lg.environmental@lge.com

The model and serial number of the product are located on the back and on one side of the product.

Record them below in case you ever need service.

Model \_\_\_\_\_

Serial No. \_\_\_\_\_