



43QNE81A\*  
50QNE81A\*  
55QNE81A\*  
65QNE81A\*  
75QNE81A\*  
86QNE81A\*

50QNE86A\*  
55QNE86A\*  
65QNE86A\*  
75QNE86A\*  
86QNE86A\*

65QNE87A\*  
75QNE87A\*



www.lg.com

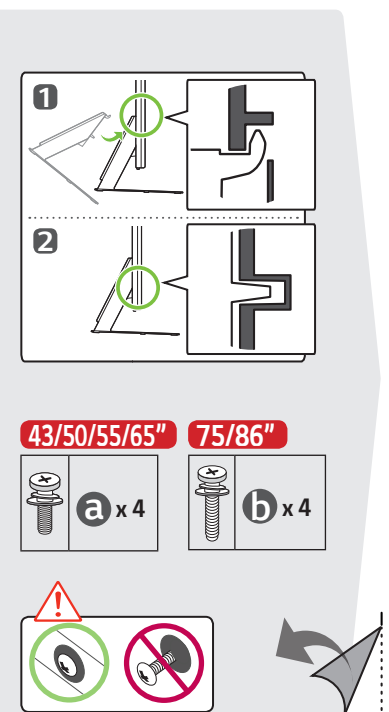
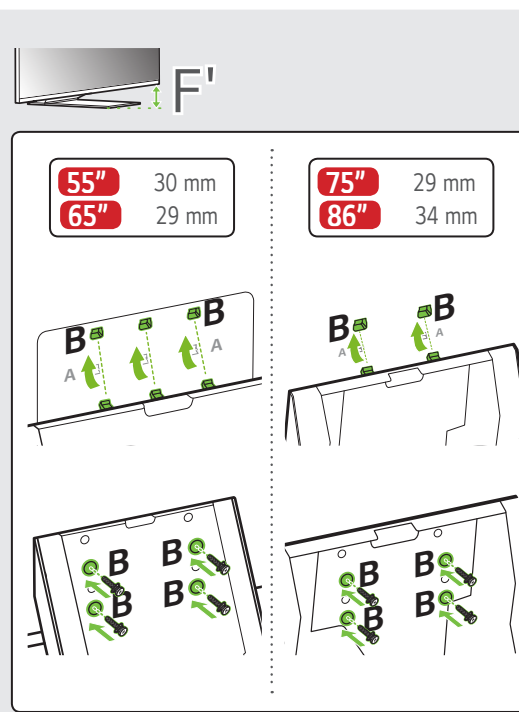
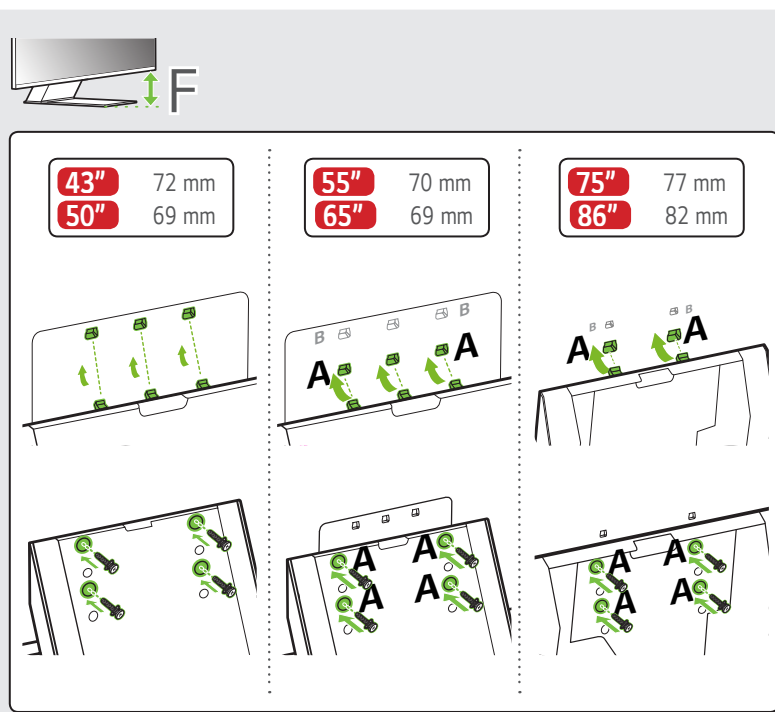
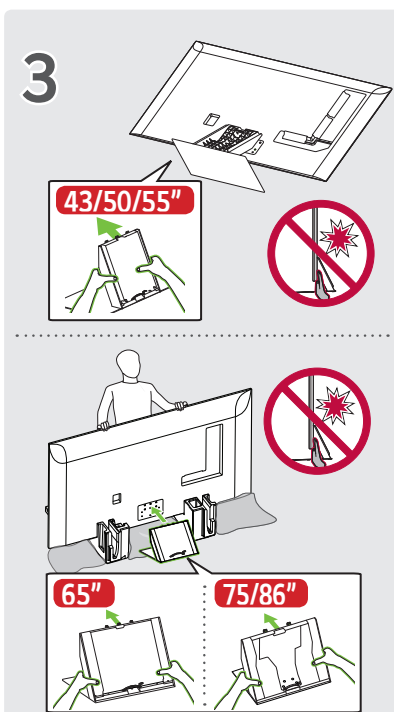
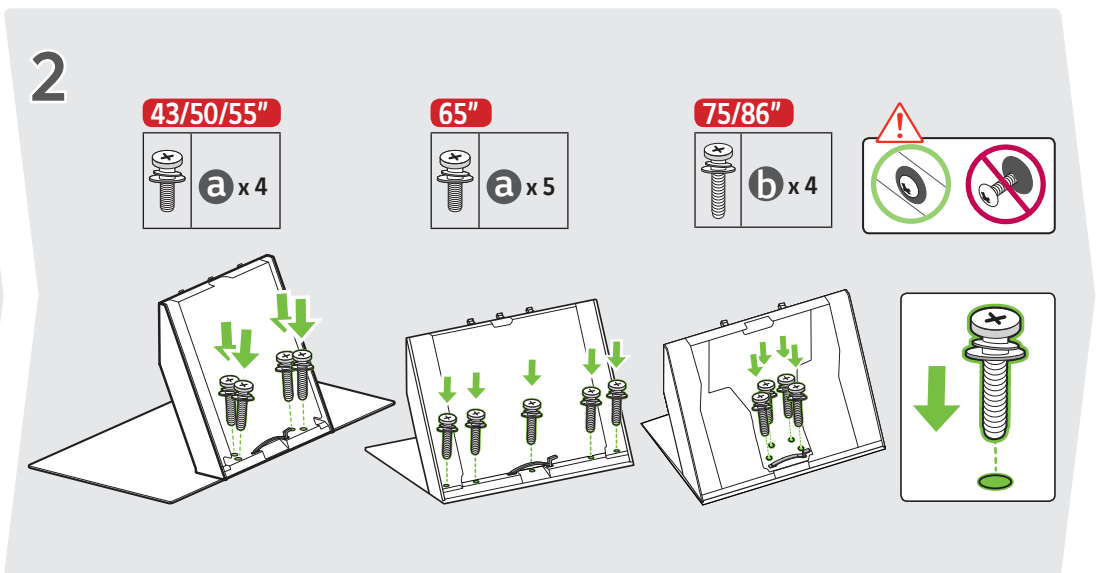
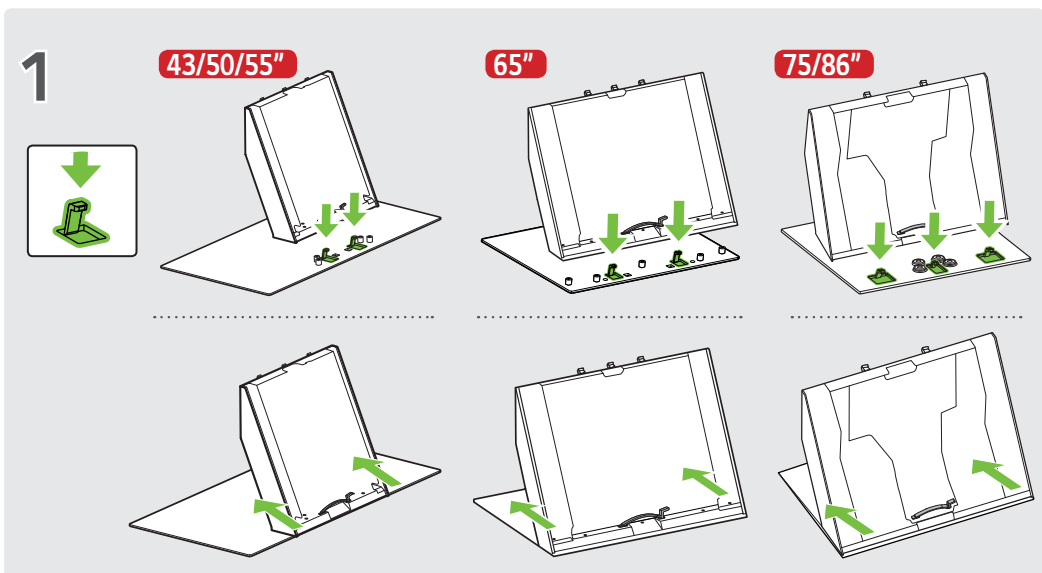
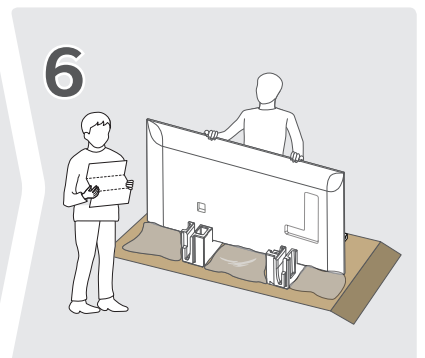
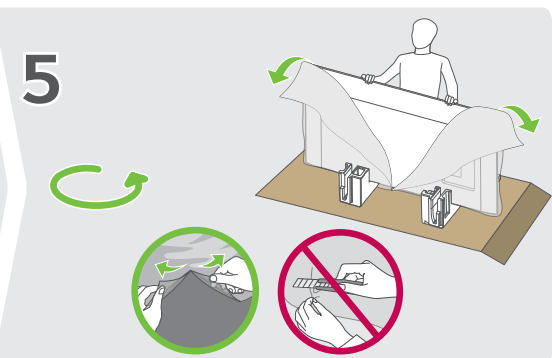
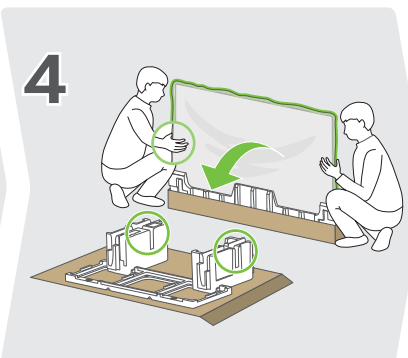
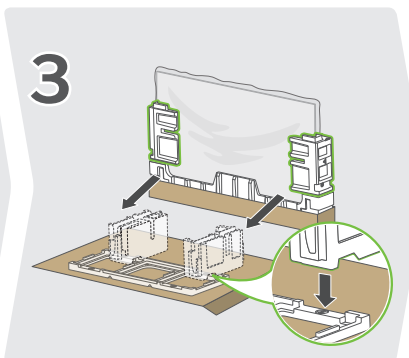
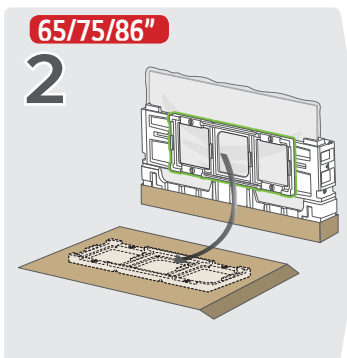
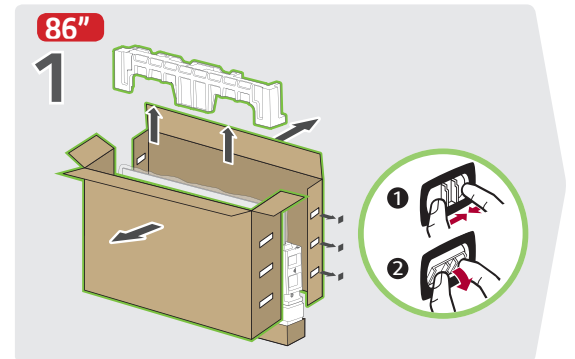
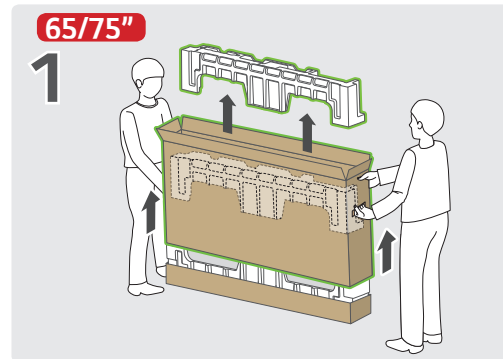
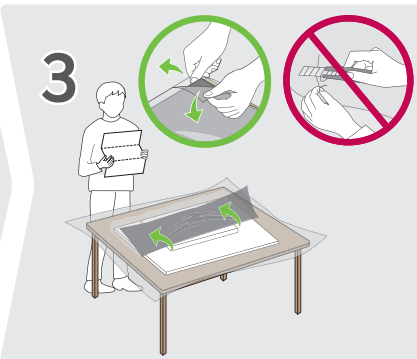
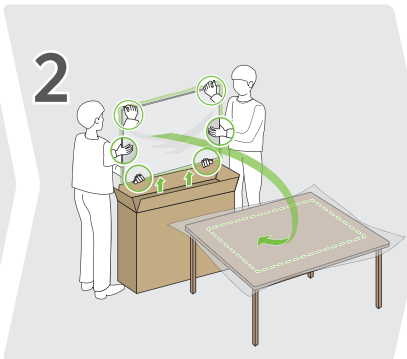
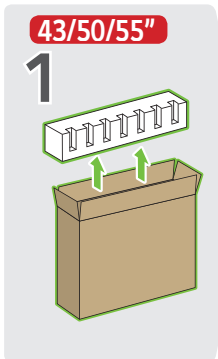
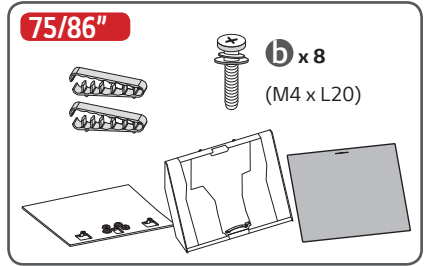
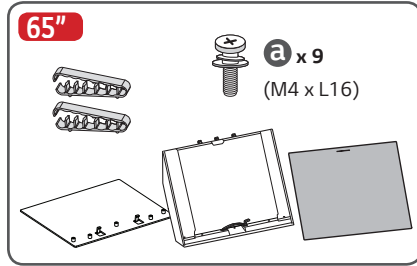
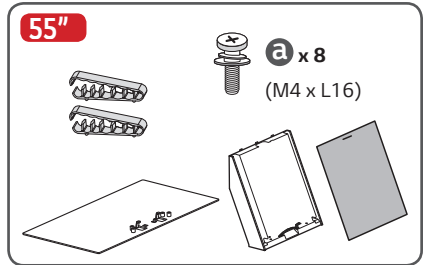
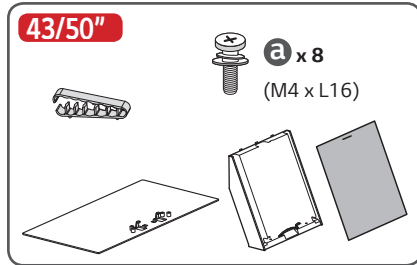
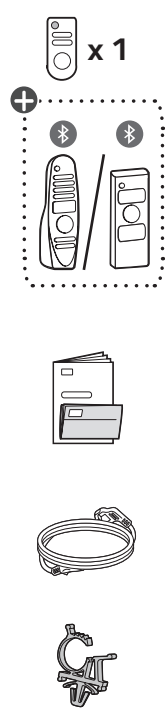

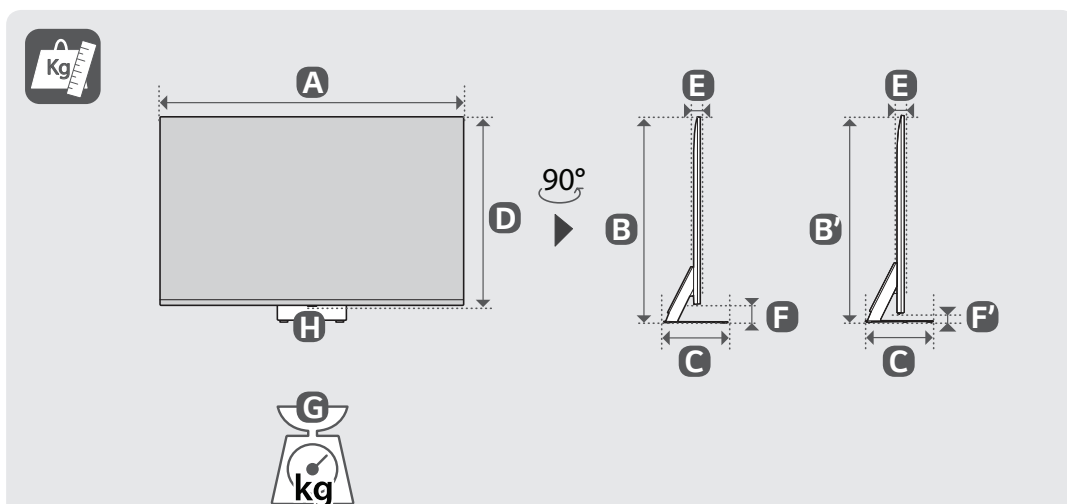
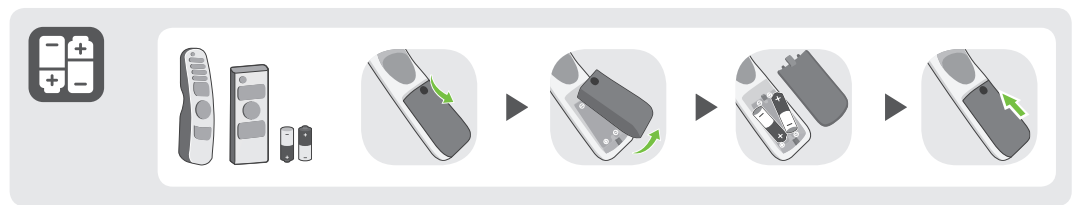
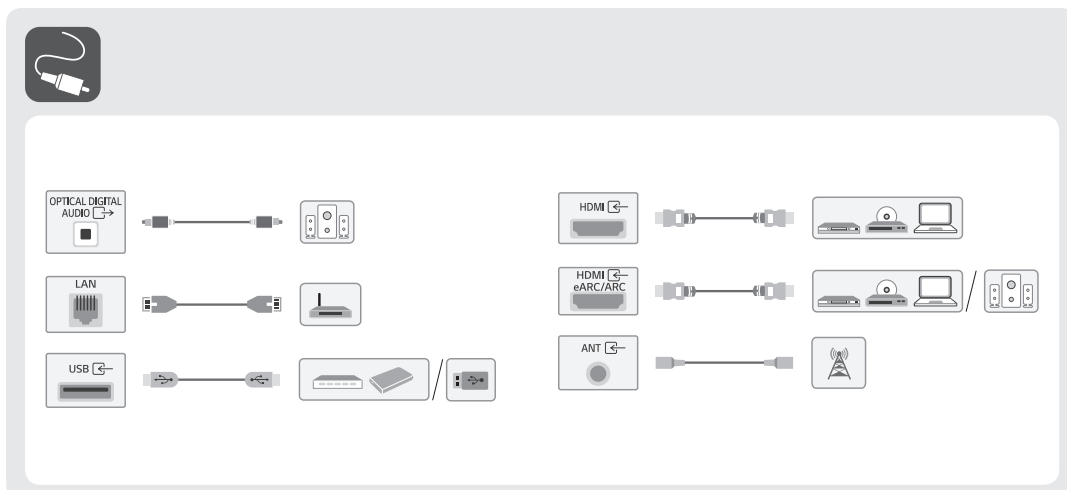
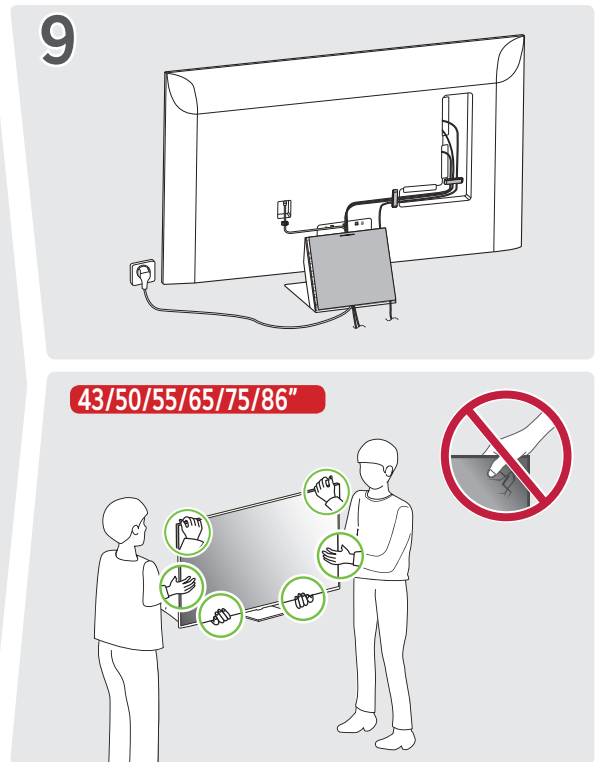
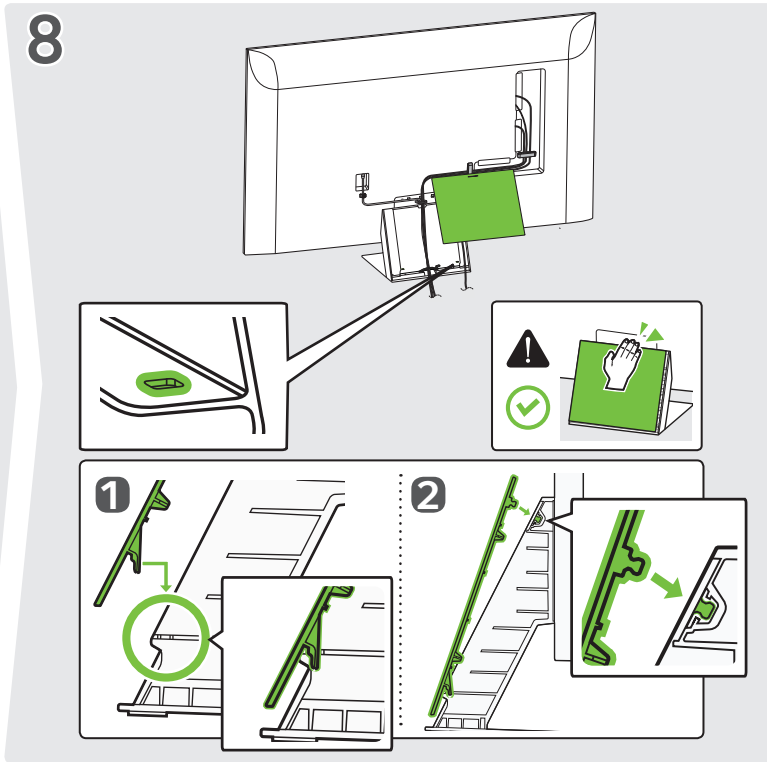
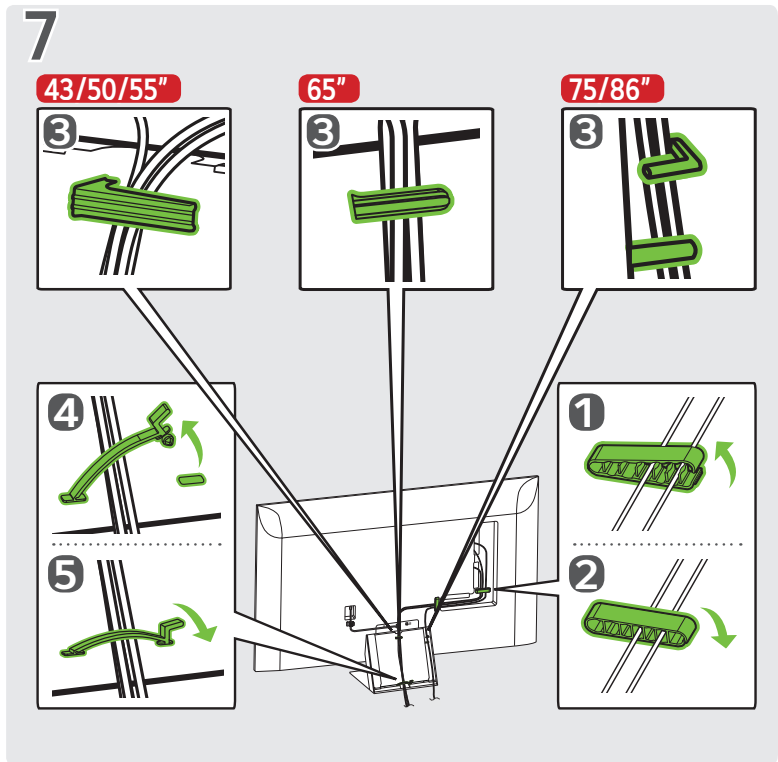
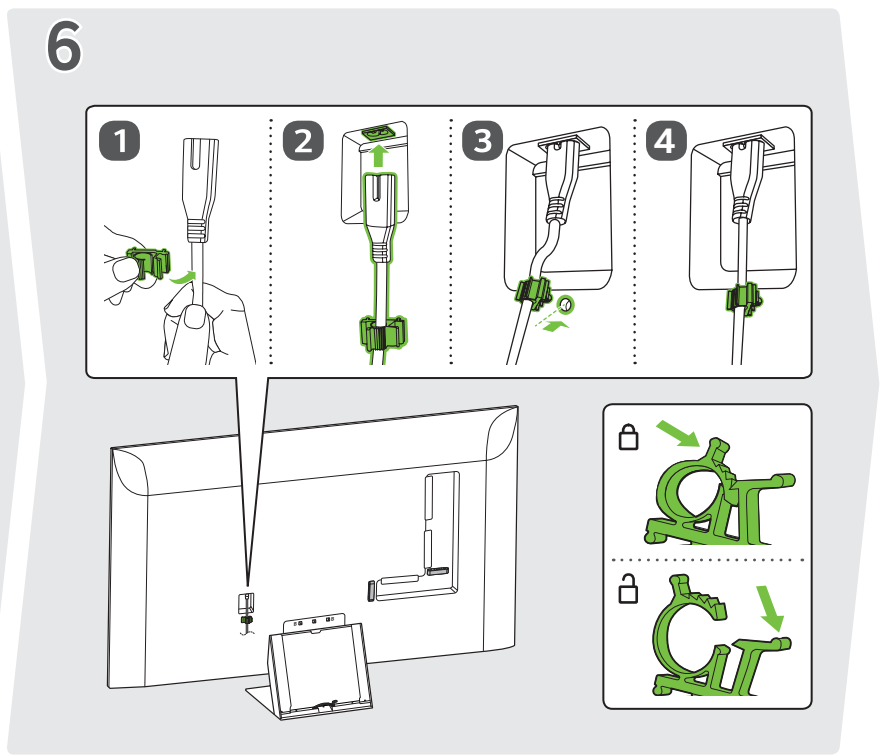
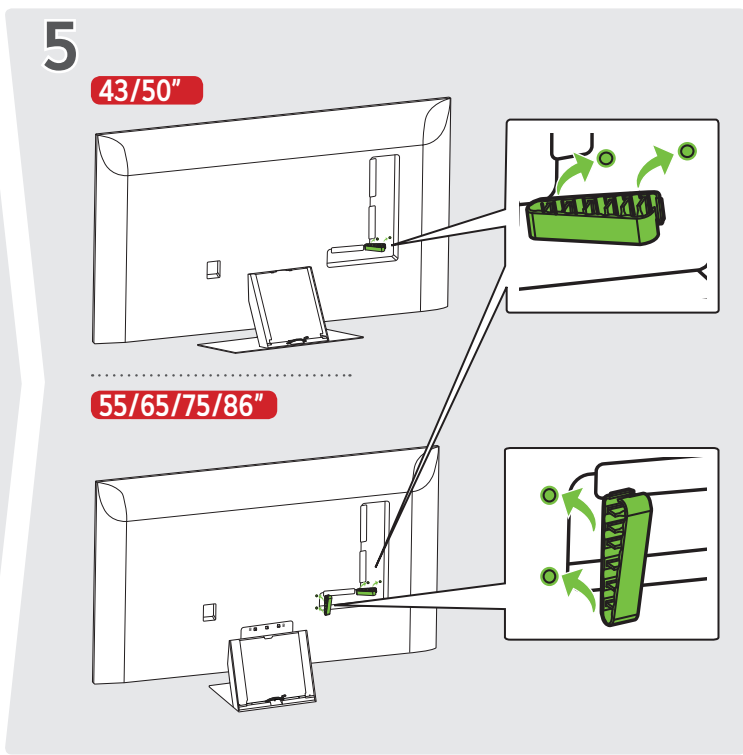
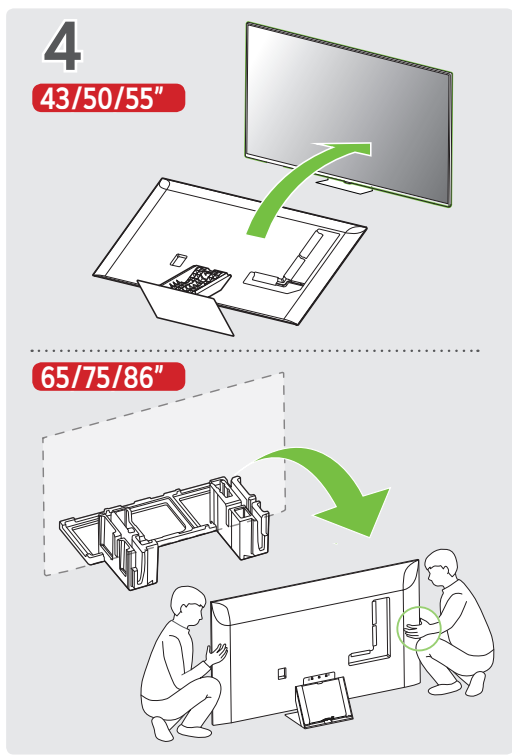

	A	B	C x D (mm)	E (mm)	F (mm)	G (m)	H (mm)
LSW240B	43QNE81A*		200 x 200	M6	287	≥ 1.5	190
MSW240	50QNE81A* 50QNE86A*				364		221
WB24GCB	55QNE81A* 55QNE86A*		300 x 300	M6	371		277
WB24GCB	65QNE81A* 65QNE86A* 65QNE87A*		300 x 300	M6	481		295
WB24GCB	75QNE81A* 75QNE86A* 75QNE87A*		400 x 300	M6	532		341
WB24GDB	86QNE81A* 86QNE86A*		600 x 400	M8	573		336

	A	B	C (mm)	D
WB21LMB	43QNE81A*	50QNE81A* 50QNE86A*	200	M6
WB21LMB	55QNE81A* 55QNE86A*	65QNE81A* 65QNE86A* 65QNE87A*	300	M6

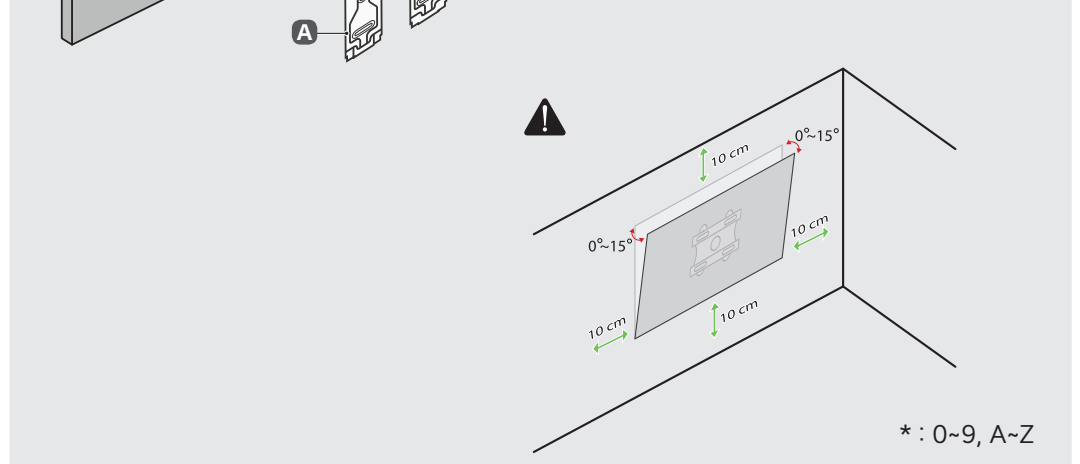

	A	B/B'	C	D	E	F/F'	G	G-H
	(mm)				(kg)			
43QNE81A*	968	637 / -	260	565	29.7	72 / -	13.1	9.3
50QNE81A* 50QNE86A*	1123	721 / -	260	652	29.7	69 / -	16.4	12.6
55QNE81A* 55QNE86A*	1236	786 / 746	260	716	29.7	70 / 30	19.3	15.5
65QNE81A* 65QNE86A* 65QNE87A*	1456	909 / 869	285	840	29.7	69 / 29	26.3	22.5
75QNE81A* 75QNE86A* 75QNE87A*	1677	1042 / 994	370	965	30.9	77 / 29	41.5	33.3
86QNE81A* 86QNE86A*	1928	1190 / 1142	370	1108	30.9	82 / 34	58.2	50.0

\* : 0-9, A-Z