

INSTALLATION MANUAL

AIR CONDITIONER

Please read this installation manual completely before installing the product.
Installation work must be performed in accordance with the national wiring standards by authorized personnel only.
Please retain this installation manual for future reference after reading it thoroughly.

CEILING CASSETTE

Original instruction

[Representative] LG Electronics Inc. EU Representative : LG Electronics European Shared Service Center B.V.
Krijgsman 1, 1186 DM Amstelveen, The Netherlands

[Manufacturer] LG Electronics Inc. Changwon 2nd factory 84, Wanam-ro, Seongsan-gu, Changwon-si,
Gyeongsangnam-do, KOREA

For more information, Refer to the CD or LG Web site (www.lg.com).



P/NO : MFL67855405

www.lg.com

ENGLISH

ITALIANO

ESPAÑOL

FRANÇAIS

DEUTSCH

EMHNIKA

ČEŠTINA

NEDERLANDS

POLSKI

LIMBA ROMÂNĂ

CONTENTS

OUT-LINE OF INSTALLATION

Safety Precautions	3
Installation of Indoor	6
1) Selection of the best location	6
2) Ceiling opening dimensions and hanging bolt location(unit: mm).....	8
3) The Indoor Unit Installation	9
4) Remote Controller Installation	9
5) Wiring Connection.....	12
ELECTRICAL WIRING.....	13
6) Connecting Pipes to the Indoor Unit	14
PIPING CONNECTION.....	15
7) Installation of Decorative Panel.....	16
8) Indoor Unit Drain Piping.....	18
HEAT INSULATION.....	19
Test running	19
1) PRECAUTIONS IN TEST RUN.....	19
CHECK THE FOLLOWING ITEMS WHEN INSTALLATION IS COMPLETE.....	19
2) Connection of power supply.....	20
3) Evaluation of the performance	20
Optional Operation	21
1) Test Run Mode.....	21
2) Setting Address of Central Control.....	22
3) Thermistor	23
4) Ceiling Height Selection	24
5) Group Setting	25
6) Dry Contact Mode Setting.....	26
7) Celsius / Fahrenheit Switching.....	27
8) Optional Function Setting.....	28
Installer Setting Code Table	29

Safety Precautions

To prevent injury to the user or other people and property damage, the following instructions must be followed.

- Incorrect operation due to ignoring instruction will cause harm or damage. The seriousness is classified by the following indications.

⚠ WARNING This symbol indicates the possibility of death or serious injury.

⚠ CAUTION This symbol indicates the possibility of injury or damage.

- Meanings of symbols used in this manual are as shown below.



Be sure not to do.



Be sure to follow the instruction.

⚠ WARNING

■ Installation

Do not use a defective or underrated circuit breaker. Use this appliance on a dedicated circuit.

- There is risk of fire or electric shock.

For electrical work, contact the dealer, seller, a qualified electrician, or an Authorized Service Center.

- Do not disassemble or repair the product. There is risk of fire or electric shock.

Always ground the product.

- There is risk of fire or electric shock.

Install the panel and the cover of control box securely.

- There is risk of fire or electric shock.

Always install a dedicated circuit and breaker.

- Improper wiring or installation may cause fire or electric shock

Use the correctly rated breaker or fuse.

- There is risk of fire or electric shock.

Do not modify or extend the power cable.

- There is risk of fire or electric shock.

Be cautious when unpacking and installing the product.

- Sharp edges could cause injury. Be especially careful of the case edges and the fins on the condenser and evaporator.

For installation, always contact the dealer or an Authorized Service Center.

- There is risk of fire, electric shock, explosion, or injury.

Do not install the product on a defective installation stand.

- It may cause injury, accident, or damage to the product.

Be sure the installation area does not deteriorate with age.

- If the base collapses, the air conditioner could fall with it, causing property damage, product failure, and personal injury.

Do not let the air conditioner run for a long time when the humidity is very high and a door or a window is left open.

- Moisture may condense and wet or damage furniture.

Use a vacuum pump or Inert (nitrogen) gas when doing leakage test or air purge. Do not compress air or oxygen and do not use flammable gases. Otherwise, it may cause fire or explosion.

- There is risk of fire or failure of product.

■ Operation

Do not store or use flammable gas or combustibles near the product.

- There is risk of fire or failure of product.

⚠ CAUTION**■ Installation**

Always check for gas (refrigerant) leakage after installation or repair of product.

- Low refrigerant levels may cause failure of product.

Install the drain hose to ensure that water is drained away properly.

- A bad connection may cause water leakage.

Keep level even when installing the product.

- To avoid vibration or water leakage.

Do not install the product where the noise or hot air from the outdoor unit could damage the neighborhoods.

- It may cause a problem for your neighbors.

Use two or more people to lift and transport the product.

- Avoid personal injury.

Do not install the product where it will be exposed to sea wind (salt spray) directly.

- It may cause corrosion on the product. Corrosion, particularly on the condenser and evaporator fins, could cause product malfunction or inefficient operation.

Installation of Indoor

Selection of the best location

1. Indoor unit

- There should not be any heat source or steam near the unit.
- There should not be any obstacles to prevent the air circulation.
- A place where air circulation in the room will be good.
- A place where drainage can be easily obtained.
- A place where noise prevention is taken into consideration.
- Do not install the unit near the door way.
- Ensure the spaces indicated by arrows from the wall, ceiling, or other obstacles.
- The indoor unit must keep the maintenance space.

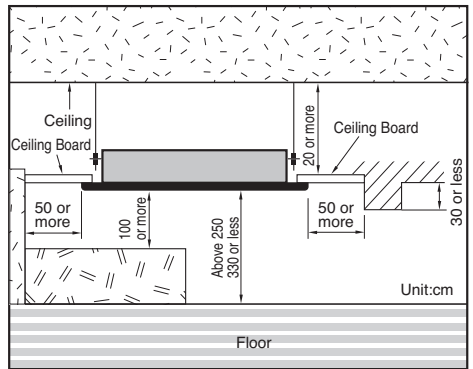
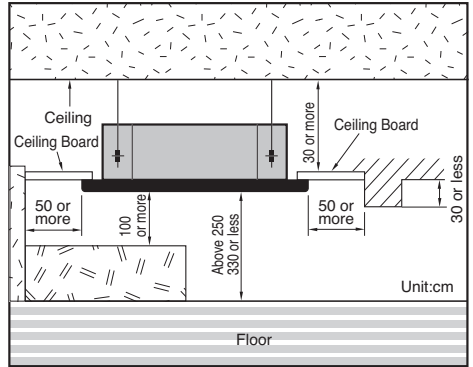

* Please use an annexed sheet or the corrugated cardboard on the bottom of packing as installation sheet.



Annexed sheet

Or

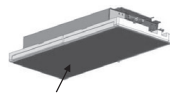

Packing corrugated cardboard on the bottom

* When using the bottom sheet, please use it after separating the installation sheet from packing of the product floor by using a knife etc as a picture below.

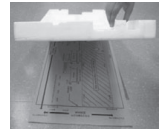

Ceiling opening dimensions and hanging bolt location

- The dimensions of the paper model for installing are the same as those of the ceiling opening dimensions.
- Select and mark the position for fixing bolts and piping hole.
- Decide the position for fixing bolts slightly tilted to the drain direction after considering the direction of drain hose.
- Drill the hole for anchor bolt on the wall.

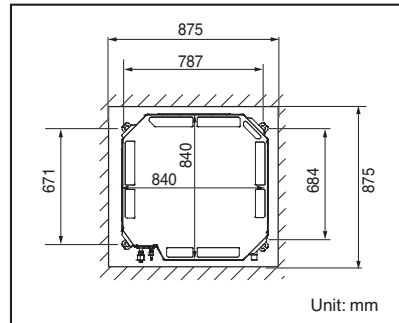
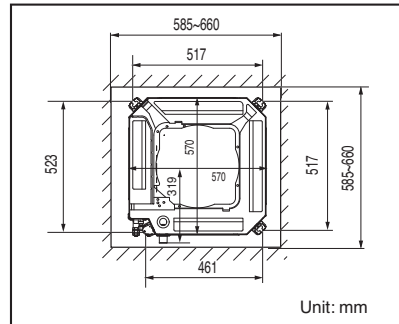
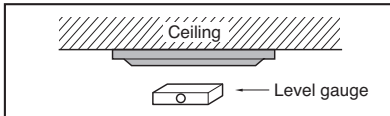

CAUTION:

- This air-conditioner uses a drain pump.
- Horizontally install the unit using a level gauge.
- During the installation, care should be taken not to damage electric wires.

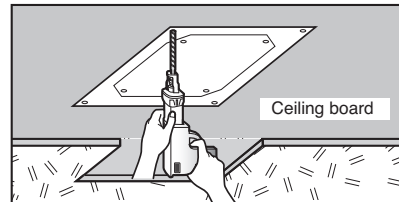

NOTICE

- Thoroughly study the following installation locations:
 1. In such places as restaurants and kitchens, considerable amount of oil steam and flour adhere to the turbo fan, the fin of the heat exchanger and the drain pump, resulting in heat exchange reduction, spraying, dispersing of water drops, drain pump malfunction, etc.
In these cases, take the following actions:
 - Make sure that the ventilation fan for smoke-collecting hood on a cooking table has sufficient capacity so that it draws oily steam which should not flow into the suction of the air conditioner.
 - Make enough distance from a cooking room to install the air conditioner in such a place where it may not suck in oily steam.

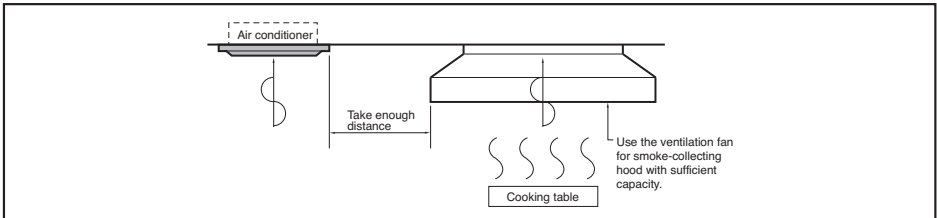

2. Avoid installing air conditioner in such circumstances where cutting oil mist or iron powder is in suspension in factories, etc.
3. Avoid places where inflammable gas is generated, flows in, is stored or vented.
4. Avoid places where sulfurous acid gas or corrosive gas is generated.
5. Avoid places near high frequency generators.

The Indoor Unit Installation

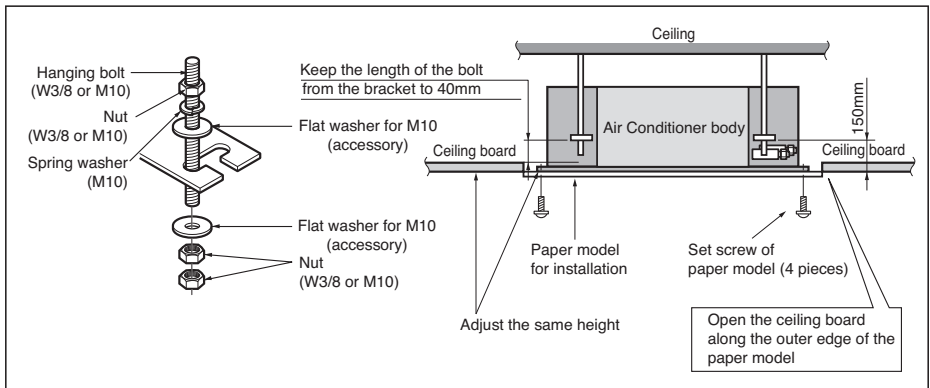

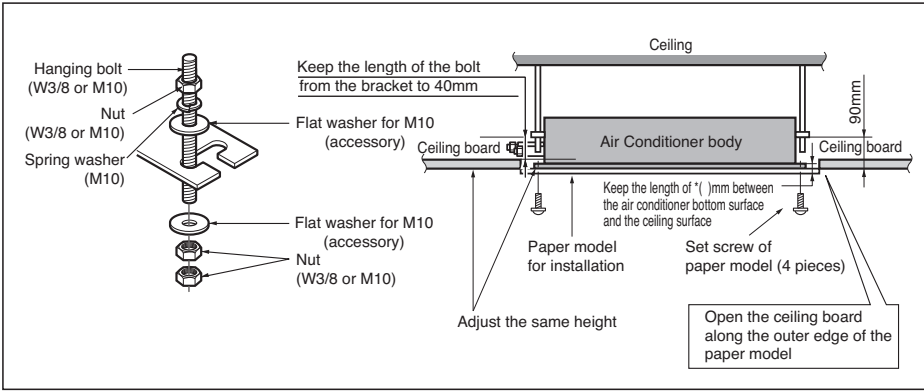

• The following parts is option.

- ① Hanging Bolt - W 3/8 or M10
- ② Nut - W 3/8 or M10
- ③ Spring Washer - M10
- ④ Plate Washer - M10

• Drill the piping hole on the wall slightly tilted to the outdoor side using a $\varnothing 70$ hole-core drill.



CAUTION: Tighten the nut and bolt to prevent unit falling.

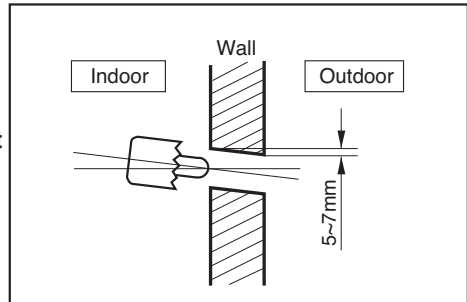

* () → TQ/TR : 31~34mm
 TP : 15mm

Remote Controller Installation

1. Please fix tightly using provided screw after placing remote controller setup board on the place where you like to setup.

- Please set it up not to bend because poor setup could take place if setup board bends.
Please set up remote controller board fit to the reclamation box if there is a reclamation box.
- Install the product so as not to make a gap with the wall side and to prevent shaking after the installation.

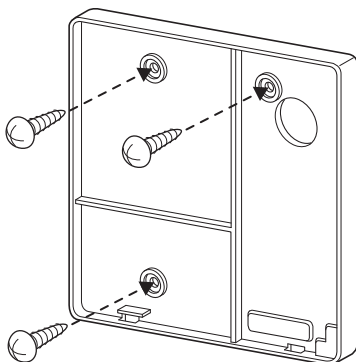

2. Can set up Wired remote controller cable into three directions.

- Setup direction: the surface of wall reclamation, upper, right
- If setting up remote controller cable into upper and right side, please set up after removing remote controller cable guide groove.

※ Remove guide groove with long nose.

- ① Reclamation to the surface of the wall
- ② Upper part guide groove
- ③ Right part guide groove

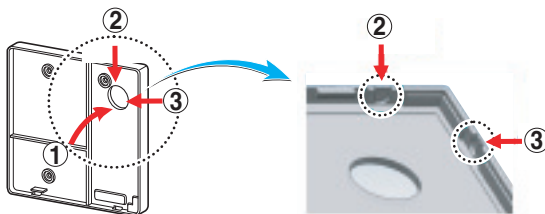

<Wire guide grooves>

3. Please fix remote controller upper part into the setup board attached to the surface of the wall, as the picture below, and then, connect with setup board by pressing lower part.

- Please connect not to make a gap at the remote controller and setup board's upper and lower, right and left part.
- Before assembly with the installation board, arrange the Cable not to interfere with circuit parts.

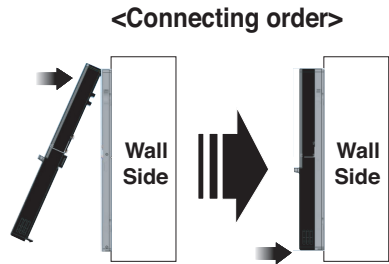

When separating remote controller from setup board, as the picture below, after inserting into the lower separating hole using screw driver and then, spinning clockwise, remote controller is separated.

- There are two separating holes. Please individually separate one at a time.
- Please be careful not to damage the inside components when separating.

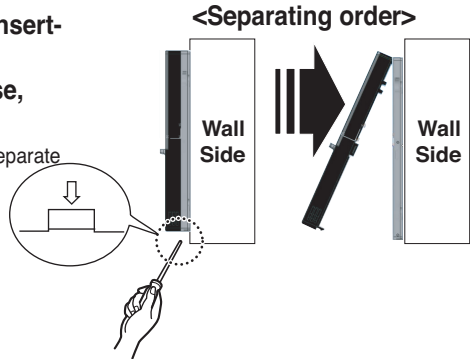

4. Please connect indoor unit and remote controller using connection cable.

12V	Red
Signal	Yellow
GND	Black

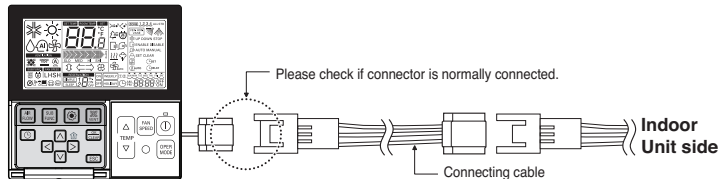

5. Please use extension cable if the distance between wired remote controller and indoor unit is more than 10m.

⚠ CAUTION

When installing the wired remote controller, do not bury it in the wall.

(It can cause damage in the temperature sensor.)

Do not install the cable to be 50m or above.

(It can cause communication error.)

- When installing the extension cable, check the connecting direction of the connector of the remote controller side and the product side for correct installation.
- If you install the extension cable in the opposite direction, the connector will not be connected.
- Specification of extension cable: 2547 1007 22# 2 core 3 shield 5 or above.

Wiring Connection

- Open the control box cover and connect the Remote controller cord and Indoor power wires.

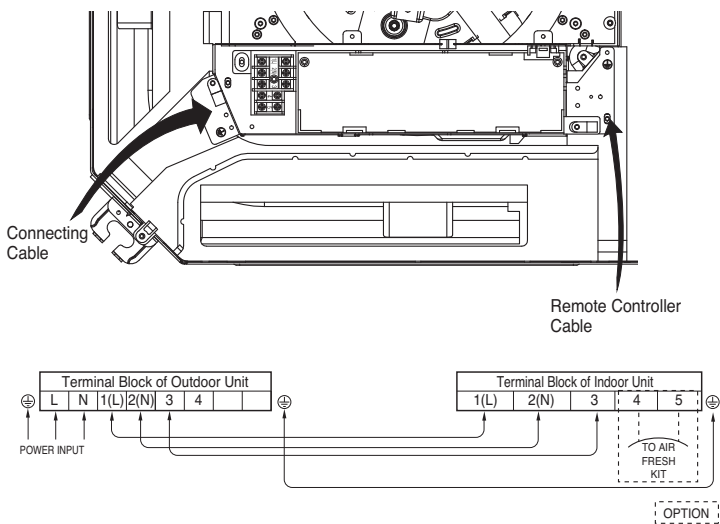

⚠ WARNING: Make sure that the screws of the terminal are free from looseness.

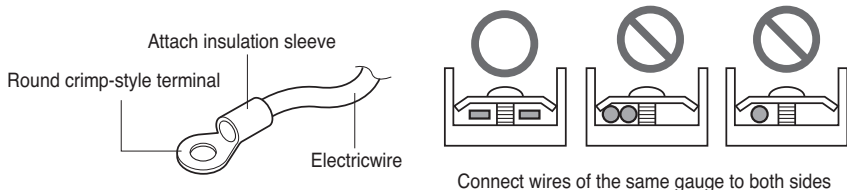

ELECTRICAL WIRING

1. All wiring must comply with LOCAL REGULATIONS.
2. Select a power source that is capable of supplying the current required by the air conditioner.
3. Feed the power source to the unit via a distribution switch board designed for this purpose.
4. The terminal screws inside the control box may be loose due to vibration during transport.
Check the screws for loose connection.
(Running the air conditioner with loose connection can overload and damage electrical components.)
5. Always ground the air conditioner with a grounding wire and connector to meet the LOCAL REGULATION.

Connecting Pipes to the Indoor Unit

Preparation of Piping

Main cause of gas leakage is defect in flaring work. Carry out correct flaring work in the following procedure.

1. Cut the pipes and the cable.

- Use the accessory piping kit or the pipes purchased locally.
- Measure the distance between the indoor and the outdoor unit.
- Cut the pipes a little longer than measured distance.
- Cut the cable 1.5m longer than the pipe length.

2. Burrs removal

- Completely remove all burrs from the cut cross section of pipe/tube.
- Put the end of the copper tube/pipe to downward direction as you remove burrs in order to avoid to let burrs drop in the tubing.

3. Putting nut on

- Remove flare nuts attached to indoor and outdoor units, than put them on pipe/tube having completed burr removal. (Not possible to put them on after flaring work)

4. Flaring work

- Carry out flaring work using dedicated flaring tool for R-410A as shown below.

Outside diameter		A
mm	inch	mm
Ø6.35	1/4	1.1~1.3
Ø9.52	3/8	1.5~1.7
Ø12.7	1/2	1.6~1.8
Ø15.88	5/8	1.6~1.8
Ø19.05	3/4	1.9~2.1

Firmly hold copper tube in a bar(or die) as indicated dimension in the table above.

5. Check

- Compare the flared work with figure below.
- If flare is noted to be defective, cut off the flared section and do flaring work again.

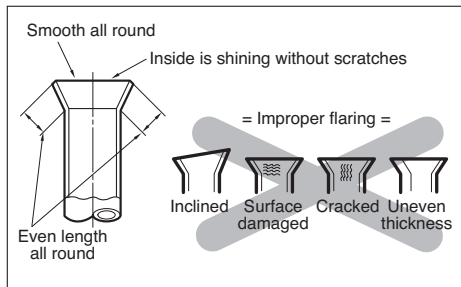
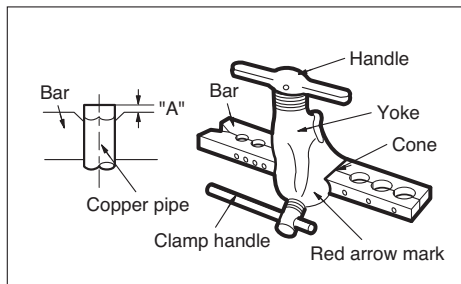
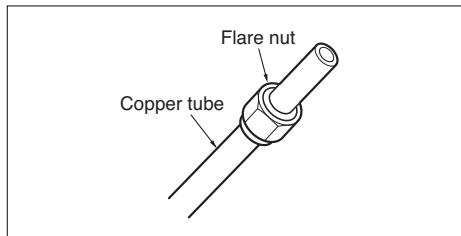
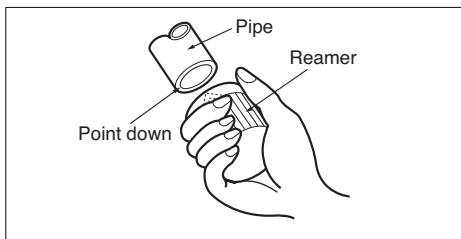
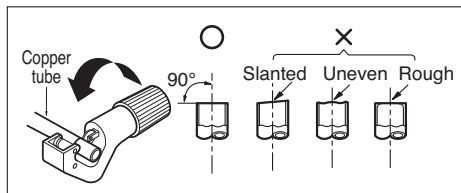

Piping Connection

1. Form the piping according to its routing. Avoid bending and bending back the same piping point more than three times. (This will result in hardening the pipe.)
2. After deforming the piping, align centers of the union fitting of the indoor unit and the piping, and tighten them firmly with wrenches.
3. Connect pipe to the service valve or ball valve which is located below the outdoor unit.
4. After completing the piping connection, be sure to check if there is gas leakage in indoor and outdoor connection.

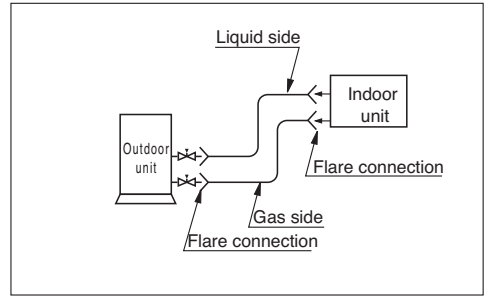

Vacuum drying

After completing the piping connection, execute vacuum drying for the connecting piping and the indoor unit. The vacuum drying must be carried out using the service ports of both the liquid and gas side valves.

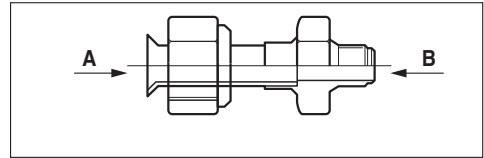

Connection of the pipes

1. When piping installation work you must be used the connector.

Indoor Units	Gas side		Liquid side	
	A	B	A	B
24k	Ø15.88	Ø12.7	Ø9.52	Ø6.35
30k, 36k	-	-	Ø9.52	Ø6.35

Flare nut fastening torque		
mm	inch	kgf·m
Ø6.35	1/4	1.8~2.5
Ø9.52	3/8	3.4~4.2
Ø12.7	1/2	5.5~6.6
Ø15.88	5/8	6.3~8.2
Ø19.05	3/4	9.9~12.1

Connecting pipe size

Indoor Units	Gas side	Liquid side
7k, 9k, 12k	Ø9.52	Ø6.35
18k, 24k	Ø12.7	Ø6.35
30k, 36k	Ø15.88	Ø6.35

2. Align the center of the pipings and sufficiently tighten the flare nut by hand
3. Finally, tighten the flare nut with torque wrench until the wrench clicks.

- When tightening the flare nut with torque wrench, ensure the direction for tightening follows the arrow on the wrench.



CAUTION: Use two wrenches and tighten with regular torque.

Installation of Decorative Panel

**The decorative panel has its installation direction.
Before installing the decorative panel, always remove the paper template.**

1. Remove the packing and take out air inlet grille from front panel.

Front grille

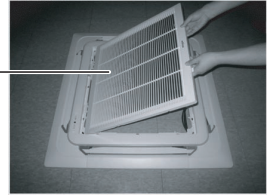

2. Remove the Corner covers of the panel.

Coner cover

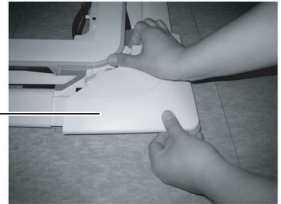

3. Fit the panel on the unit by inserting hooks as shown in picture.

Hook clip

Hook

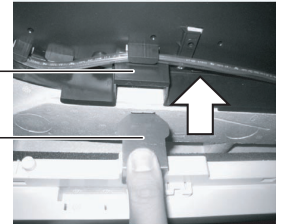

4. Insert two screws on diagonal corners of panel. Do not tighten the bolts completely. (The fixing screws are included in the indoor unit box.)
Check the alignment of panel with the ceiling. Height can be adjusted using hanging bolts as shown in picture. Insert the other two screws and tighten all screws completely.

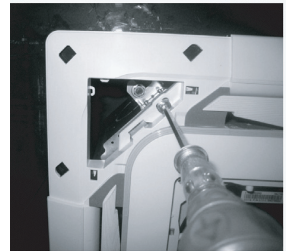

5. Fit the corner covers.

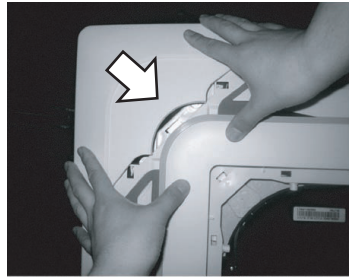

6. Open two screws of control panel cover.

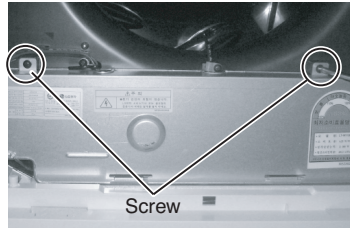

7. Connect one display connector and two vane control connectors of front panel to indoor unit PCB.

The position marking on PCB is as:

Display connector : CN-DISPLAY

Vane control connector: CN-VANE 1,2

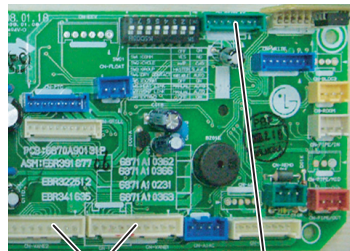

CN-VANE 1,2 CN-DISPLAY

8. Close the cover for control box.

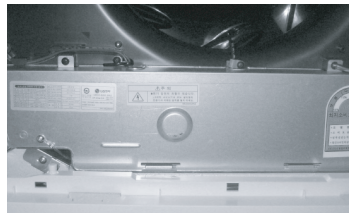

9. Install the air inlet grille and Filter on the panel.

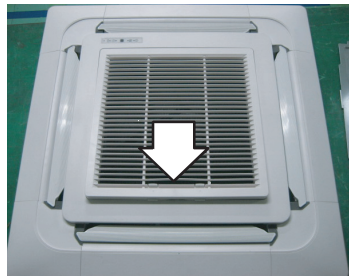

CAUTION: Install certainly the decorative panel.
Cool air leakage causes sweating. ☞ Water drops fall.

Good example

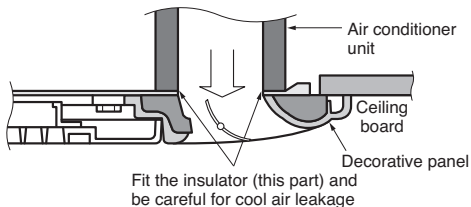

Bad example

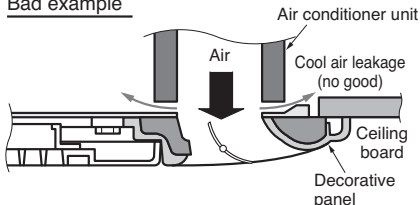

Indoor Unit Drain Piping

- Drain piping must have down-slope (1/50 to 1/100); be sure not to provide up-and-down slope to prevent reversal flow.
- During drain piping connection, be careful not to exert extra force on the drain port on the indoor unit.
- The outside diameter of the drain connection on the indoor unit is 32mm.

Piping material: Polyvinyl chloride pipe VP-25 and pipe fittings

- Be sure to execute heat insulation on the drain piping.

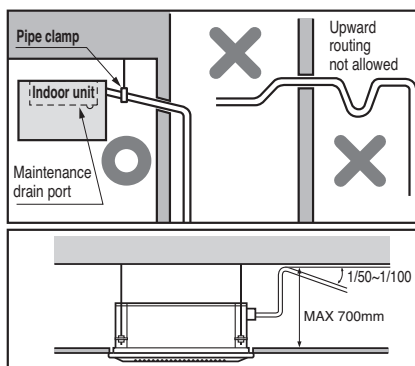

Heat insulation material: Polyethylene foam with thickness more than 8 mm.

DRAIN TEST

The air conditioner uses a drain pump to drain water.
Use the following procedure to test the drain pump operation:

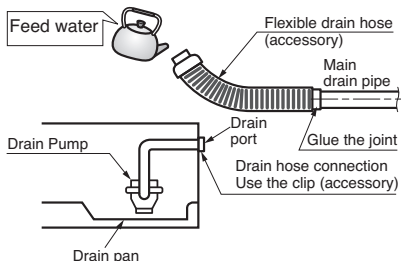

- Connect the main drain pipe to the exterior and leave it provisionally until the test comes to an end.
- Feed water to the flexible drain hose and check the piping for leakage.
- Be sure to check the drain pump for normal operating and noise when electrical wiring is complete.
- When the test is complete, connect the flexible drain hose to the drain port on the indoor unit.

HEAT INSULATION

1. Use the heat insulation material for the refrigerant piping which has an excellent heat-resistance (over 120°C).

2. Precautions in high humidity circumstance:

This air conditioner has been tested according to the "KS Standard Conditions with Mist" and confirmed that there is not any default. However, if it is operated for a long time in high humid atmosphere (dew point temperature: more than 23°C), water drops are liable to fall. In this case, add heat insulation material according to the following procedure:

- Heat insulation material to be prepared... Adiabatic glass wool with thickness 10 to 20mm.
- Stick glass wool on all air conditioners that are located in ceiling atmosphere.

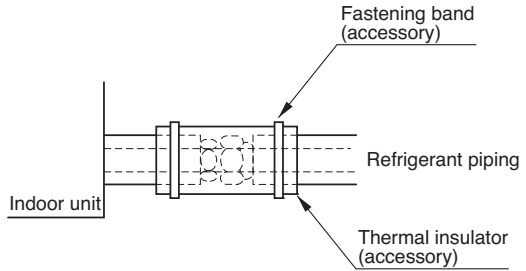

Test running

1. PRECAUTIONS IN TEST RUN

- The initial power supply must provide at least 90% of the rated voltage. Otherwise, the air conditioner should not be operated.



CAUTION ① For test run, carry out the cooling operation firstly even during heating season. If heating operation is carried out firstly, it leads to the trouble of compressor. Then attention must be paid.

② Carry out the test run more than 5 minutes without fail.
(Test run will be cancelled 18 minutes later automatically)

- The test run is started by pressing the room temperature checking button and down timer button for 3 seconds at the same time.
- To cancel the test run, press any button.

CHECK THE FOLLOWING ITEMS WHEN INSTALLATION IS COMPLETE

- After completing work, be sure to measure and record trial run properties, and store measured data, etc.
- Measuring items are room temperature, outside temperature, suction temperature, blow out temperature, wind velocity, wind volume, voltage, current, presence of abnormal vibration and noise, operating pressure, piping temperature, compressive pressure.
- As to the structure and appearance, check following items.

<ul style="list-style-type: none"> <input type="checkbox"/> Is the circulation of air adequate? <input type="checkbox"/> Is the draining smooth? <input type="checkbox"/> Is the heat insulation complete (refrigerant and drain piping)? <input type="checkbox"/> Is there any leakage of refrigerant? 	<ul style="list-style-type: none"> <input type="checkbox"/> Is the remote controller switch operated? <input type="checkbox"/> Is there any faulty wiring? <input type="checkbox"/> Are not terminal screws loosened?
---	--

M4.....118N·cm{12kgf·cm} M5.....196N·cm{20kgf·cm}
M6.....245N·cm{25kgf·cm} M8.....588N·cm{60kgf·cm}

2. Connection of power supply

1. Connect the power supply cord to the independent power supply.

- Circuit breaker is required.

2. Operate the unit for fifteen minutes or more.

3. Evaluation of the performance

1. Measure the temperature of the intake and discharge air.
2. Ensure the difference between the intake temperature and the discharge one is more than 8°C (Cooling) or reversely (Heating).

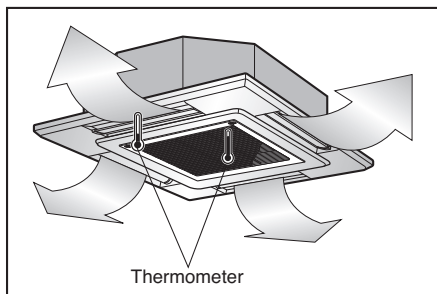

CAUTION: After the confirmation of the above conditions, prepare the wiring as follows:

- 1) Never fail to have an individual power specialized for the air conditioner. As for the method of wiring, be guided by the circuit diagram pasted on the inside of control box cover.
- 2) Provide a circuit breaker switch between power source and the unit.
- 3) The screw which fasten the wiring in the casing of electrical fittings are liable to come loose from vibrations to which the unit is subjected during the course of transportation. Check them and make sure that they are all tightly fastened. (If they are loose, it could give rise to burn-out of the wires.)
- 4) Specification of power source
- 5) Confirm that electrical capacity is sufficient.
- 6) Be sure that the starting voltage is maintained at more than 90 percent of the rated voltage marked on the name plate.
- 7) Confirm that the cable thickness is as specified in the power sources specification. (Particularly note the relation between cable length and thickness.)
- 8) Never fail to equip a leakage breaker where it is wet or moist.
- 9) The following troubles would be caused by voltage drop-down.
 - Vibration of a magnetic switch, damage on the contact point there of, fuse breaking, disturbance to the normal function of a overload protection device.
 - Proper starting power is not given to the compressor.

HAND OVER

Teach the customer the operation and maintenance procedures, using the operation manual (air filter cleaning, temperature control, etc.).

Optional Operation

Installer Setting - Test Run Mode

After installing the product, you must run a Test Run mode.

For details related to this operation, refer to the product manual.

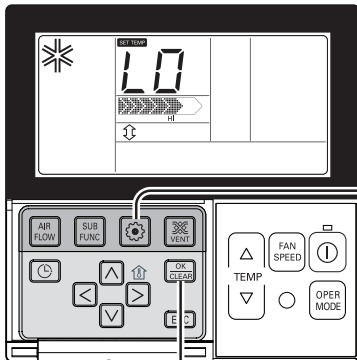

1 If pressing  button long for 3 seconds, it enters into remote controller setter setup mode.

- If pressing once shortly, it enters into user setup mode. Please press more than 3 seconds for sure.
- Please cancel the right and left of wind direction for RAC product.

 Function Code Set

2 Setup figure '01' blinks at the lower part of indication window.

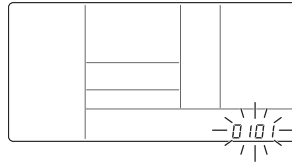

3 Press  button to start.

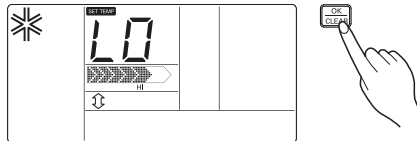



4 During the test run, pressing the below button will exit the test run.

- Select operation, temperature up/down, wind flow control, wind direction, start/stop button.

Installer Setting - Setting Address of Central Control

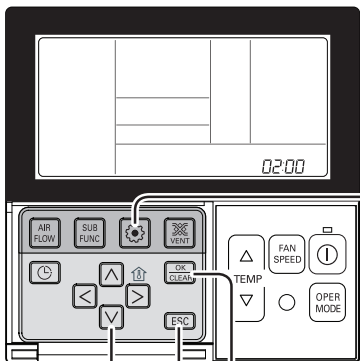
It's the function to use for connecting central control.
Please refer to central controller manual for the details





1 If pressing  button long for 3 seconds, it enters into remote controller setter setup mode.
- If pressing once shortly, it enters into user setup mode. Please press more than 3 seconds for sure.



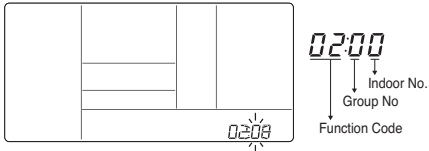

2 If entering into address setup mode by using  button, it indicates as picture below.



3 Set Group No. by pressing   button.(0~F)

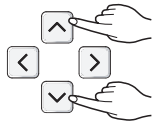

02:F0

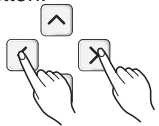

4 Move to Indoor No. setting option by pressing   button.

02:F0



5 Set Indoor No. by pressing   button.

02:F5

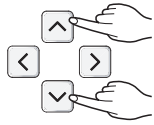

6 Press  button to save.

02:F5





7 Pressing  button will exit settings mode.
* After setup, it automatically gets out of setup mode if there is no button input for 25 seconds.
* When exiting without pressing set button, the manipulated value is not reflected.

Installer Setting -Thermistor

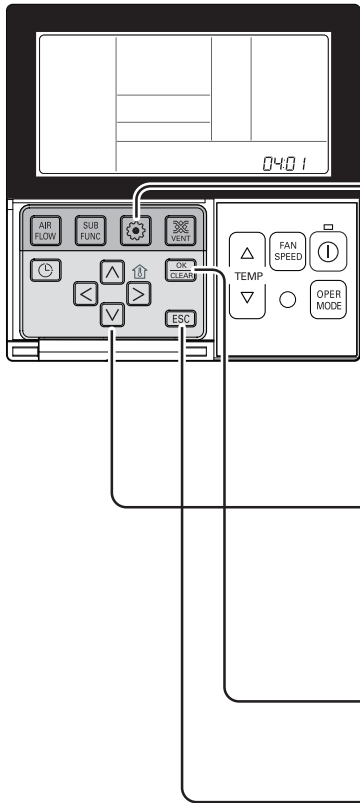

This is the function to select the temperature sensor to judge the room temperature.



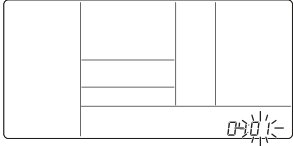

1 If pressing  button long for 3 seconds, it enters into remote controller setter setup mode.
- If pressing once shortly, it enters into user setup mode. Please press more than 3 seconds for sure.

2 If moving to room temperature perception sensor selection menu by pressing  button, it indicates as picture below.

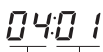

3 Set Thermistor value by pressing   button. (01: Remote Controller, 02: Indoor, 03: 2TH)

Function Code Thermistor setting

4 Press  button to save.



5 Pressing  button will exit settings mode.
* After setup, it automatically gets out of setup mode if there is no button input for 25 seconds.
* When exiting without pressing set button, the manipulated value is not reflected.

<Thermistor Table>

Temperature sensor selection		Function	
01	Remote controller	Operation in remote controller temperature sensor	
02	Indoor unit	Operation in indoor unit temperature sensor	
03	2TH	Cooling	Operation of higher temperature by comparing indoor unit's and wired remote controller's temperature. (There are products that operate at a lower temperature.)
		Heating	Operation of lower temperature by comparing indoor unit's and wired remote controller's temperature.

* The function of 2TH has different operation characteristics according to the product.

Installer Setting -Ceiling Height Selection

This function is to adjust FAN Airflow rate according to ceilingheight (only cassette model)

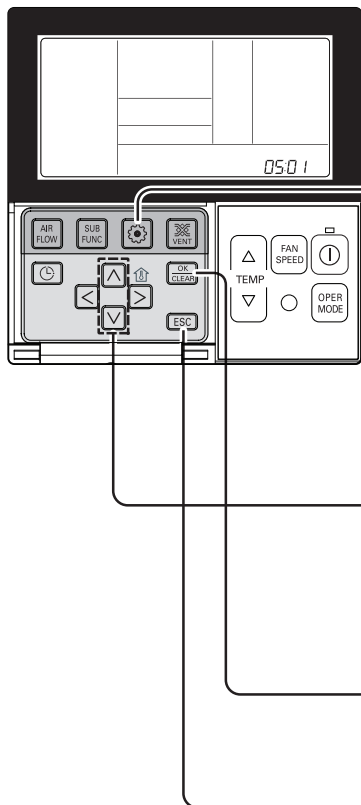

- 1** If pressing button long for 3 seconds, it enters into remote controller setter setup mode.
- If pressing once shortly, it enters into user setup mode. Please press more than 3 seconds for sure.

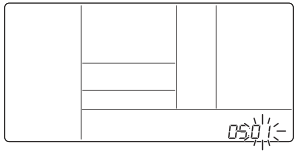

- 2** If moving to ceiling height selection menu by pressing button, it indicates as picture below.

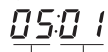
- 3** Select ceiling height value by pressing button. (01:Low, 02:Standard, 03:High, 04Very high)

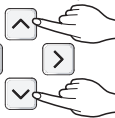

Function Code Thermistor setting

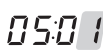
- 4** Press button to save.

- 5** Pressing button will exit settings mode.
* After setup, it automatically gets out of setup mode if there is no button input for 25 seconds.
* When exiting without pressing set button, the manipulated value is not reflected.

<Ceiling Height Selection Table>

Ceiling Height Level		Description
01	Low	Decrease the indoor airflow rate 1 step from standard level
02	Standard	Set the indoor airflow rate as standard level
03	High	Increase indoor airflow rate 1 step from standard level
04	Super high	Increase indoor airflow rate 2 steps from standard level



* Ceiling height setting is available only for some products.
* Ceiling height of 'Super high' function may not exist depending on the indoor unit.
* Refer to the product manual for more details.

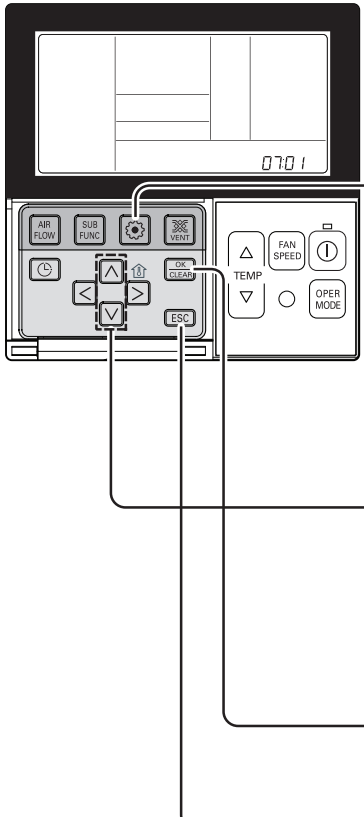

Installer Setting-Group Setting



It is a function for settings in group control, or 2-remote controller control.



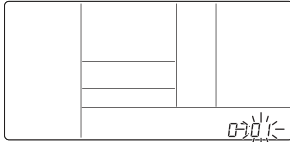

- 1** If pressing  button long for 3 seconds, it enters into remote controller setter setup mode.
- If pressing once shortly, it enters into user setup mode. Please press more than 3 seconds for sure.

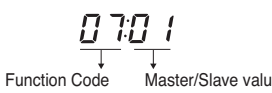
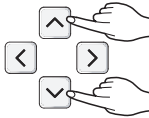
- 2** If pressing  button repeatedly, it moves to master/slave selection menu as picture below.

- 3** Select Master/ Slave by pressing   button.
(00: Slave, 01: Master)



- 4** Press  button to save.



- 5** Pressing  button will exit settings mode.
* After setup, it automatically gets out of setup mode if there is no button input for 25 seconds.
* When exiting without pressing set button, the manipulated value is not reflected.

Remote controller	Function
Master	Indoor unit operates based on master remote controller at group control. (Master is set when delivering from the warehouse.)
Slave	Setup all remote controllers except one master remote controller to slave at group control

* Refer to the 'group control' part for details

- When controlling in groups, basic operation settings, airflow strength weak/medium/strong, lock setting of the remote controller, time settings, and other functions may be restricted.

Installer Setting-Dry Contact Mode Setting

Dry contact function is the function that is possible to use only when dry contact equipment is separately purchased/setup.

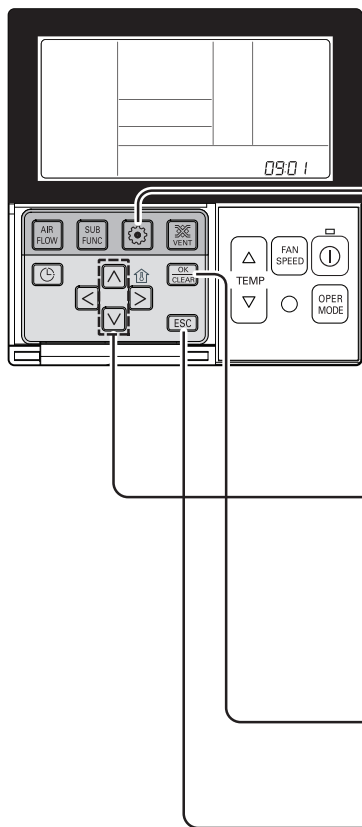



- 1** If pressing button long for 3 seconds, it enters into remote controller setter setup mode.
- If pressing once shortly, it enters into user setup mode. Please press more than 3 seconds for sure.

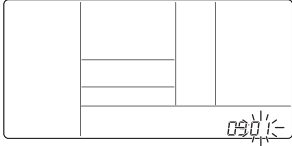

- 2** If pressing button repeatedly, it moves to remote controller dry contact mode setup menu as picture below.

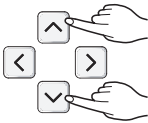
- 3** Select Dry contact setting by pressing button.
(00 : Automatic, 01 : manual)

 Function Code Dry Contact setting value

- 4** Press button to save.



- 5** Pressing button will exit settings mode.
* After setup, it automatically gets out of setup mode if there is no button input for 25 seconds.
* When exiting without pressing set button, the manipulated value is not reflected.

► What is Dry Contact?

Like hotel card key and body perception sensor, it is the signal of the point of contact when using air-conditioner by interlocking.

• Please refer to dry contact manual for more details.

Installer Setting-Celsius / Fahrenheit Switching

This function is used for switching the display between Celsius and Fahrenheit.
(Optimized only for U.S.A)

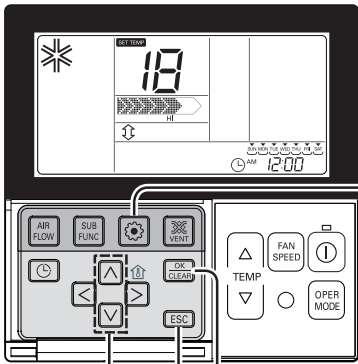

1 If pressing  button long for 3 seconds, it enters into remote controller setter setup mode.
- If pressing once shortly, it enters into user setup mode.
Please press more than 3 seconds for sure.





2 Repeat pressing  button to select Function code 12.

12:00

Function Code conversion mode value

Ex) Fahrengit Setting

3 Select Temperature unit mode by pressing   button.
(00: Celsius, 01: Fahrenheit)

12:01

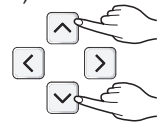

4 Press  button to save or release.

12:01

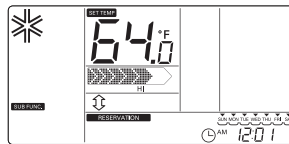

5 Press  button to exit or system will automatically exit after 25 seconds without any input.



* Whenever press   button in Fahrenheit mode, the temperature will increase/drop 2 degrees.

Installer Setting -Optional Function Setting

Setting feature for indoor unit when air cleaning / heater / humidifier / Up/down grill / Ventilation KIT /Auxiliary Heater is newly installed, or installed unit is removed.

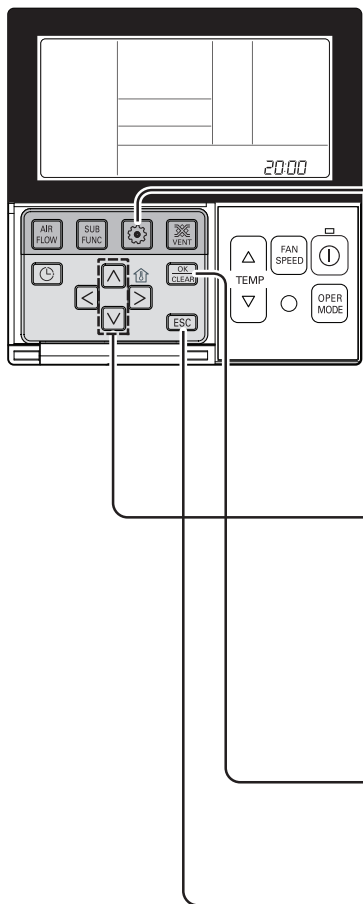

1 If pressing button long for 3 seconds, it enters into remote controller setter setup mode.
 - If pressing once shortly, it enters into user setup mode. Please press more than 3 seconds for sure.



2 If pressing button repeatedly, it moves to the selected option function code as picture below.

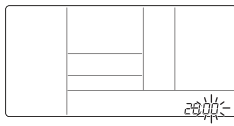

Function	Code
Plasma purification	20
Electric heater	21
Dehumidifier	22
Elevation grill	23
Ventilation kit	24
Auxiliary heater	25

3 Select existing condition of each mode by pressing button.
 (00: not installed,
 01 : installed)

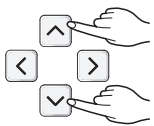

2001

Function Code Existing condition

4 Press button to save.



5 Pressing button will exit settings mode.
 * After setup, it automatically gets out of setup mode if there is no button input for 25 seconds.
 * When exiting without pressing set button, the manipulated value is not reflected.

