

43UL3J-E	65UL3J-E
50UL3J-E	75UL3J-E
55UL3J-E	

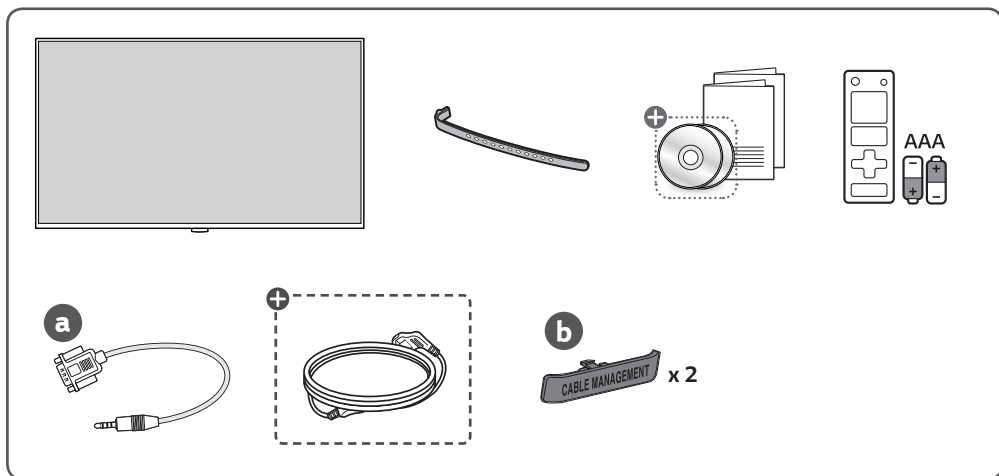

⊕ Dependendo da configuração do modelo, os itens mostrados não acompanham o produto.



- ▶ www.lg.com/id-manual
- ▶ SuperSign : <http://partner.lge.com>

Você poderá ter acesso a informações mais detalhadas em nosso site procurando o nome do modelo fornecido na primeira página deste guia.

Em relação a fonte de alimentação e consumo de energia, consulte a etiqueta do produto.

Certificado ANATEL



**TODOS OS AJUSTES DE RF,
JÁ FORAM CALIBRADOS NO
PRÓPRIO MÓDULO DE RF.**

**MÓDULO WI-FI / BLUETOOTH
MODELO: LGSBWAC95**

**Este produto contém a placa LGSBWAC95 código
de homologação da ANATEL 11530-20-01925.**



11530-20-01925

**Para maiores informações, consulte o site da
ANATEL: www.anatel.gov.br**

***Este equipamento não tem direito à
proteção contra interferência prejudicial
e não pode causar interferência em
sistemas devidamente autorizados.***

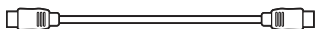

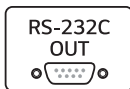
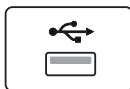
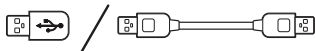
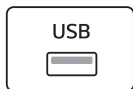
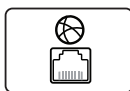
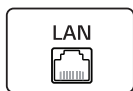

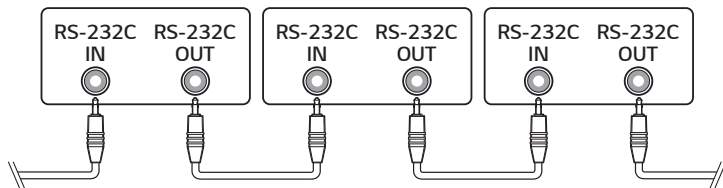

1

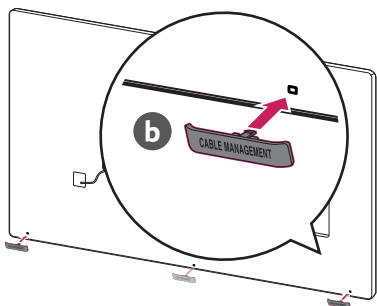

2

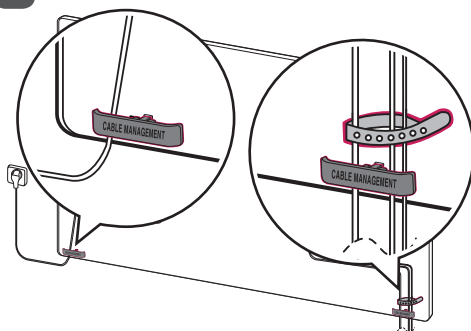



1

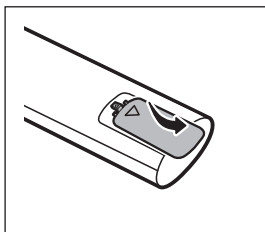

2

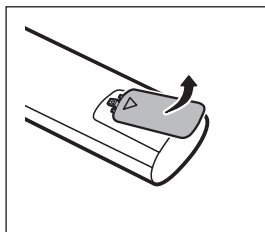

3



4

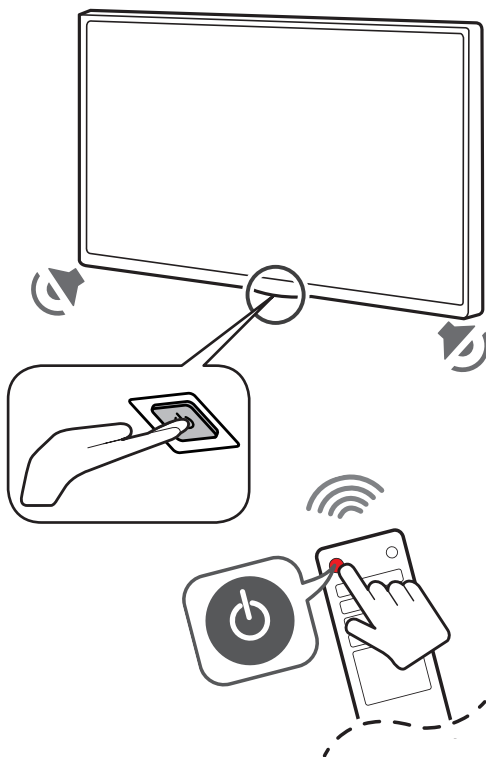
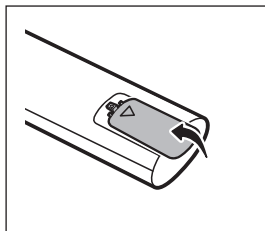



* M F L 7 1 8 0 5 2 0 4 *

(2105-REV00)

