

SEC. WORK	가	나	다	PRINTING DEGREE		MATERIAL AND PRINTING DESCRIPTION	LG MODEL 명	LANGUAGE	PAGE	REMARK
	BRAND	MODEL	P/NO.	EXTERIER	INTERIER					
76	LG	RC8066*F RC8066**F RC9066*F RC9066**F	MFL67653076	1	1	모조지 80g OFFSET 인쇄	-	영어	32	-

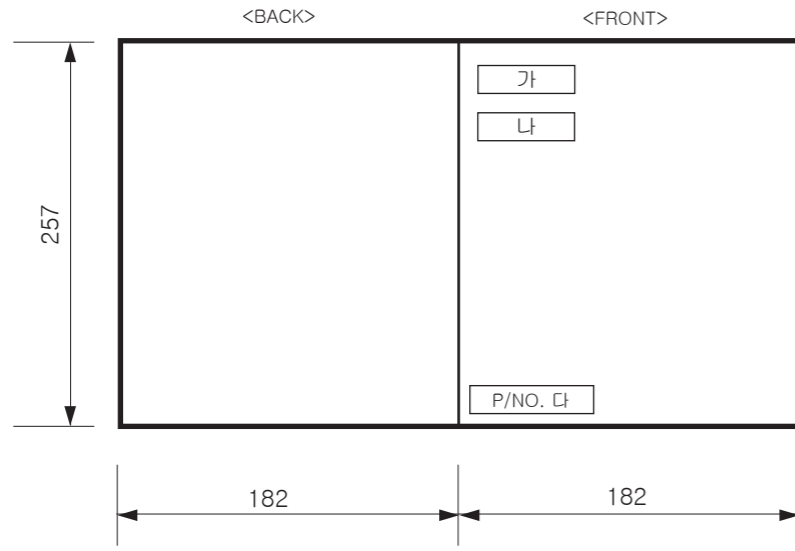

<< 주 기 >>

1. 재질, 인쇄방법, 인쇄도수, 외곽치수등은 작업표에 준한다.
2. 인쇄내용, 문자크기 및 형상, 선의 굵기 등은 설계에서 제시된 FILM에 준함.
3. 외곽치수는 절단후 치수임.
4. 양산전에 설계 한도를 득할 것.
5. 본 부품에 금지물질이 포함되지 않도록 하고, 상세 내용은 LG(63)-A-5501-34를 만족할 것.

<< NOTES >>

1. Material, printing and exterier size are refer to work tables.
2. Printing, text size and line are based on LG design film.
3. Exterier size on the drawing is cutting line.
4. Before product controlled by criteria sample.
5. The part should not contain prohibited substances(Pb,Cd,Hg,Cr+6,PBB,PBDE) and details should comply with LG standard of LG(63)-A-5501-34.

PDF ILLUSTRATOR
DR COMPLETED
도면 DR 완료
완료일:

REV. NO. 기호	REVISION DESCRIPTION 변경 사항	REF. NO. 시방 번호	DATE 년/월/일	PREPARED 시방자	APPROVED 승인자
△					
△	판넬 수정.	EAGG300324	16.03.08	김진영	한일탁
△	언어표기 삭제.	EAGG100494	16.01.14	김진영	한일탁

TRIG.	UNIT	mm	SCALE	1/1
MODELING	DESIGNED	REVIEWED	CHECKED	APPROVED
	김진영 15.12.18		김한수 15.12.18	한일탁 15.12.21
LG 전자 (주) LG Electronics Inc.			RELATED DWG.	DWG. No.

MANUAL, OWNER'S
Neo Prime(D)-PJT 1/1
MFL67653076



OWNER'S MANUAL

DRYER



Before beginning installation, read these instructions carefully.

This will simplify installation and ensure that the product is installed correctly and safely. Leave these instructions near the product after installation for future reference.

RC8066**F RC8066*F
RC9066**F RC9066*F



MFL67653076
Rev.02_030816

www.lg.com

TABLE OF CONTENTS

This manual is produced for a group of products and may contain images or content different from the model you purchased.

This manual is subject to revision by the manufacturer.

SAFETY INSTRUCTIONS	03
Important Safety Instructions	04
INSTALLATION	07
Specifications	07
Accessories (Optional)	07
Installation Place Requirements	08
Stacking Installation Instructions	09
OPERATION	12
Using the Appliance	12
Sorting Laundry	13
Control Panel	14
Programme Table	15
Option Cycle	18
Rack Dry (Optional)	20
Using Smart Function (Optional)	21
MAINTENANCE	22
Cleaning the Lint Filter	22
Emptying the Water Container	23
Cleaning the Cool Air Inlet Grill	23
Wiping the Moisture Sensor	23
Cleaning the Condenser	24
Using the Smart Diagnosis™ Function	25
TROUBLESHOOTING	26
Diagnosing Problems	26
Error Codes	29
WARRANTY	30

SAFETY INSTRUCTIONS

The following safety guidelines are intended to prevent unforeseen risks or damage from unsafe or incorrect operation of the product.

The guidelines are separated into 'WARNING' and 'CAUTION' as described below.

 This symbol is displayed to indicate matters and operations that can cause risk. Read the part with this symbol carefully and follow the instructions in order to avoid risk.

 **WARNING** - This indicates that the failure to follow the instructions can cause serious injury or death.

 **CAUTION** - This indicates that the failure to follow the instructions can cause the minor injury or damage the product.

WARNING

To reduce the risk of fire, electric shock, or injury to persons when using your product, basic safety precautions should be followed, including the following:

Children in the Household

This appliance is not intended for use by persons (including children) with reduced physical, sensory or mental capabilities, or lack of experience and knowledge, unless they have been given supervision or instruction concerning use of the appliance by a person responsible for their safety. Children should be supervised to ensure that they do not play with the appliance.

For use in Europe:

This appliance can be used by children aged from 8 years and above and persons with reduced physical, sensory or mental capabilities or lack of experience and knowledge if they have been given supervision or instruction concerning use of the appliance in a safe way and understand the hazards involved. Children shall not play with the appliance. Cleaning and user maintenance shall not be made by children without supervision.

Children of less than 3 years should be kept away unless continuously supervised.

Important Safety Instructions

WARNING

To reduce the risk of fire, electric shock, or injury to persons when using your product, basic safety precautions should be followed, including the following:

Installation

- Make sure the appliance is properly installed, grounded, and adjusted by qualified service personnel according to the installation instructions.
- Never attempt to operate the appliance if it is damaged, malfunctioning, partially disassembled, or has missing or broken parts, including a damaged cord or plug. It can cause electric shock or injury.
- The appliance is heavy. Two or more people may be needed to install and move the appliance. Failure to do so can result in injury.
- Store and install the appliance where it will not be exposed to temperatures below freezing or exposed to outdoor weather conditions. Failure to do so can result in leakage.
- Tighten the drain hose to avoid separation. Splashing of water may cause electric shock.
- If the supply cord is damaged, it must be replaced by the manufacturer or its service agents or similarly qualified person in order to avoid a hazard.
- The appliance must not be installed behind a lockable door, a sliding door or a door with a hinge on the opposite side to that of the appliance, in such a way that a full opening of the appliance door is restricted.

Operation

- Do not use a sharp object like drill or pin to press or separate an operation unit. It can cause the electric shock or injury.
- Only an authorized repair person from LG Electronics service centre should disassemble, repair, or modify the appliance. Improper service may cause injury, electric shock or fire.
- Do not spray the water inside or outside the appliance to clean it. Water can damage the insulation, causing electric shock or fire.
- Keep the area underneath and around the appliance free of combustible materials such as lint, paper, rags, chemicals, etc. Improper use can cause fire or explosion.
- Do not put living animals, such as pets into the appliance. It may cause injury.
- Do not leave the appliance door open. Children may hang on the door or crawl inside the appliance, causing damage or injury.

- Never reach into the appliance while it is operating. Wait until the drum has completely stopped. Failure to do so may result in injury.
- Do not put in, wash or dry articles that have been cleaned in, washed in, soaked in, or spotted with combustible or explosive substances (such as wax, oil, paint, gasoline, degreasers, drycleaning solvents, kerosene, vegetable oil, cooking oil, etc.). Improper use can cause fire or explosion.
- In case of flood, stop using the appliance and contact the LG Electronics service centre. Contact with water can cause electric shock.
- Do not push down the door excessively, when the appliance door is open. Doing so may topple over the appliance and it can cause the injury.
- Use new hose-sets supplied with the appliance. Old hose-sets should not be reused. Water leakage may cause property damage.
- Do not touch the door during steam cycles or drying. The door surface can become very hot. Failure to do so may result in injury.
- Do not use inflammable gas and combustible substances (benzene, gasoline, thinner, petroleum, alcohol, etc.) around the appliance. It may cause explosion or fire.
- If the drain hose or inlet hose is frozen during winter, use it only after thawing. Freezing may cause fire or electric shock, and frozen parts may cause product malfunction or reduction in product life span.
- Keep all washing detergents, softener and bleach away from children. These products contain poisonous materials.
- Do not plug multiple products into multiple socket-outlets or extension cords. This can cause fire.
- Remove the power plug when you clean the appliance. Not removing the plug may result in electric shock or injury.
- Do not touch the power plug with wet hands. It can cause the electric shock or injury.
- When pulling out the power plug from an outlet, hold the power plug, not the cable. Damage of the cable can cause the electric shock or injury.
- Do not bend the power cable excessively or place a heavy object on top of it. Damage of the power cable can cause electric shock or fire.
- Do not drink the condensed water. Failure to do so may result in food-borne illnesses.
- The lint trap has to be cleaned frequently.
- Lint must not be allowed to accumulate around the appliance.

Technical Safety for Using the Appliance

- Do not dry unwashed items in the appliance.

- Items that have been soiled with substances such as cooking oil, vegetable oil, acetone, alcohol, petrol, kerosene, spot removers, turpentine, waxes and wax removers should be washed in hot water with an extra amount of detergent before being dried in the appliance.
- Fabric softeners, or similar products, should be used as specified by the fabric softener instructions.
- Remove all objects from pockets such as lighters and matches.
- Never stop the appliance before the end of the drying cycle unless all items are quickly removed and spread out so that the heat is dissipated.
- The appliance is not to be used if industrial chemicals have been used for cleaning.
- Items such as foam rubber (latex foam), shower caps, waterproof textiles, rubber backed articles and clothes or pillows fitted with foam rubber pads should not be dried in the appliance.

Disposal

- Before discarding an old appliance, unplug it. Render the plug useless. Cut off the cable directly behind the appliance to prevent misuse.
- Dispose of the packaging material (such as vinyl and styrofoam) away from children. The packaging material can suffocate a child.
- Remove the door to the appliance before the appliance is removed from service or discarded to avoid the danger of children or small animals getting trapped inside. Failure to do so can result in serious injury to persons or death.

Grounding Requirements

- For your safety, the information in this manual must be followed to minimize the risk of fire, explosion, or electric shock, or to prevent property damage, injury to persons, or death.
- The appliance must be grounded. In the event of malfunction or breakdown, grounding will reduce the risk of electric shock by providing a path of least resistance for electric current.
- The appliance is equipped with a cord having an equipment-grounding conductor and grounding plug. The plug must be plugged into an appropriate outlet that is properly installed and grounded in accordance with all local codes and ordinances.
- Improper connection of the equipment-grounding conductor can result in risk of electric shock. Check with a qualified electrician or service person if you are in doubt as to whether the appliance is properly grounded.
- Do not modify the plug provided with the appliance. If it does not fit the outlet, have a proper outlet installed by a qualified electrician.

INSTALLATION

Specifications

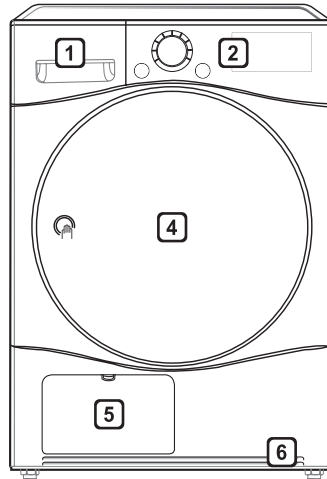
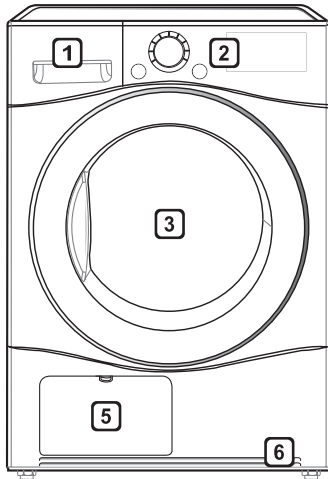

- 1 Water container
- 2 Control panel
- 3 Glass door
- 4 Opaque door
- 5 Condenser cover
- 6 Air ventilation grill

- Power supply : 220 - 240 V~, 50 Hz
- Size : 600 mm (W) 640 mm (D) 850 mm (H)
- Product weight : 43 - 46 kg
- Allowable temperature : 5 - 35 °C
- Max. capacity : RC8066**F, RC8066*F - 8 kg / RC9066**F, RC9066*F - 9 kg

- Appearance and specifications may vary without notice to improve the quality of the appliance.

Accessories (Optional)

Please contact the LG Electronics Customer Information Centre for purchase.

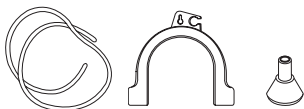

Condensing Drain Hose
and Hose Holder

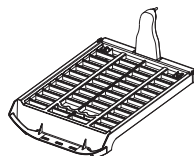

Dry Rack

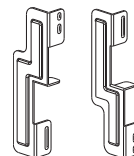

Stacking Kit

Installation Place Requirements

Location

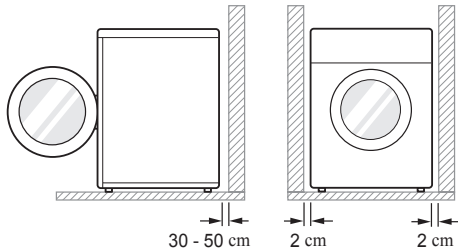

Level floor : Allowable slope under the entire appliance is 1 °.

Power outlet : Must be within 1.5 meters of either side of the location of the appliance.

- Do not overload the outlet with more than one appliance.

Additional Clearance : For the wall, 30 - 50 cm: rear
/2 cm: right & left side

- Do not place or store laundry products on top of the appliance at any time.
- These products may damage the finish or controls.

NOTE

- For better drying performance, please keep the rear of the appliance away from wall.
- Do not install the appliance where there is a risk of frost or dust.
- The appliance may not be able to operate properly or may be damaged by freezing of condensed water in the pump and drain hose.
- Do not install the appliance next to a high-temperature appliance like refrigerator, oven or stove etc, which can cause poor drying performance and programme duration, and adversely affect the proper functioning of the compressor. The appliance performs best at a room temperature of 23 °C.

Positioning

- Install the appliance on a flat hard floor.
- Make sure that air circulation around the appliance is not impeded by carpets, rugs, etc.
- Never try to correct any unevenness in the floor with pieces of wood, cardboard or similar materials under the appliance.
- Do not install the appliance in rooms where freezing temperatures may occur. Frozen hoses may burst under pressure. The reliability of the electronic control unit may be impaired at temperatures below freezing point.
- If the appliance is delivered in winter and temperatures are below freezing, place the appliance at room temperature for a few hours before putting it into operation.
- Please ensure that when the appliance is installed, it is easily accessible for an engineer in the event of a breakdown.
- With the appliance installed, adjust all four feet using a transit bolt spanner to ensure the appliance is stable, and a clearance of approximately 20 mm is left between the top of the appliance and the underside of any work-top.

Ventilation Requirement

- Alcove or under counter
 - Ensure air flow of 112 cu.ft./min through appliance
- Closet
 - Closet door must have 2 (louvered) openings, each having a minimum area of 60 sq. inches (387 sq.cm), located 3 inches (8 cm) from bottom and top of door.

WARNING

- Avoid installing the appliance around a heat source. The rear side of the appliance must be well ventilated. Failure to follow these instructions may result in problems.
- The appliance should not be installed next to a refrigeration appliance.
- The appliance is not designed for maritime use or for use in mobile installations such as caravans, aircraft etc.

Electrical Connection

- Do not use an extension cord or double adapter.
- Always unplug the appliance after use.
- Connect the appliance to an earthed socket in accordance with current wiring regulations.
- The appliance must be positioned so that the plug is easily accessible.

Stacking Installation Instructions

Your dryer can be placed on top of an LG washing machine and securely fixed with a stacking kit. This installation must be conducted by qualified service personnel to ensure it has been installed correctly.

The qualified service personnel will ensure you have the correct stacking kit for your model of washing machine and will ensure it is firmly fixed. For these reasons, expert fitting is essential.

Stacking Kit

In order to stack this dryer an LG stacking kit is required.

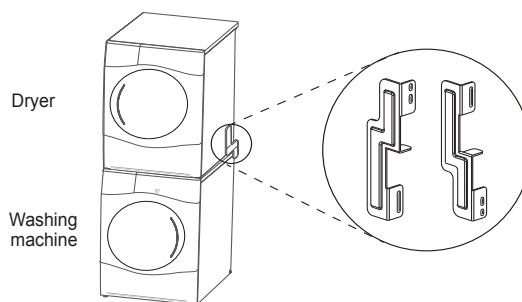

This dryer may only be stacked on top of an LG washing machine. Do not attempt to stack this dryer on any other washing machine, as damage, injury or property damage could result.

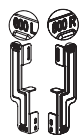
Shape and assembly direction	Washing Machine Top plate size	
	21.7 inch (550 mm)	23.6 inch (600 mm)
		

Installation Procedure

- 1 Place the LG dryer on the LG washing machine.
- 2 Remove the two screws from the bottom of the rear cover on each side as illustrated below.

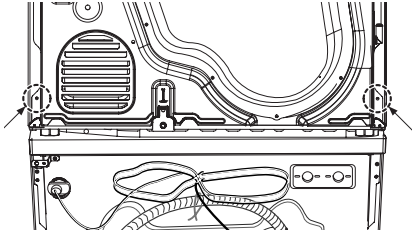

- 3 Align the stacking kit holes and the rear cover holes.

3-1) 23.6 inch (600 mm)

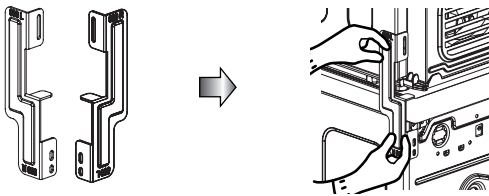

3-2) 21.7 inch (550 mm)

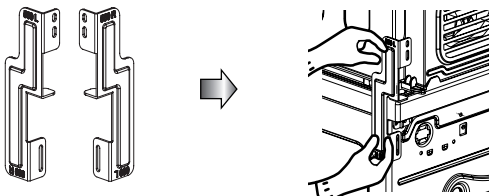

- 4 Fasten the two screws that were removed earlier from the dryer to the stacking kit.
- 5 Use the four screws in the accessory box [0.6 inch (16 mm)] to assemble the washing machine rear cover and stacking kit.
- 6 The procedure for the opposite side will be the same.

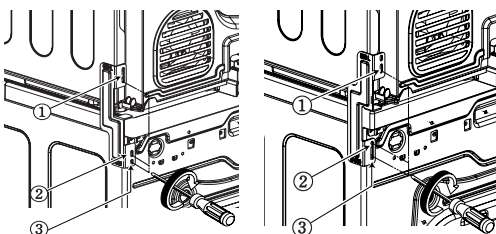

⚠ WARNING

- Incorrect installation can cause serious accidents.
- The weight of the appliance and the height of installation make the stacking procedure too risky for one person. This procedure should be performed by two or more qualified service personnel.
- The appliance is not suitable for a built-in installation. Please do not install as a built-in appliance.
- Do not operate if the appliance is not properly stacked.

Condensed Water Drain-out

Normally, condensed water is pumped up to the water container where water is collected until manually emptied. Water can also be drained out directly to a mains drain, especially when the dryer is stacked on top of a washing machine. With a connecting kit for the mains drain hose, simply change the water path and re-route to the drainage facility as below:

- 1 Take the connecting kit out.

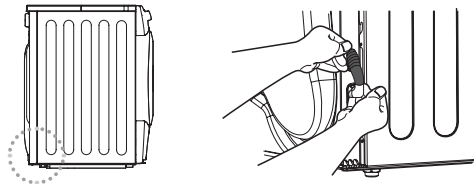

- 2 Separate the water container hose from the kit.

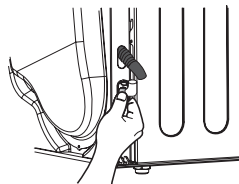

- 3 Connect the drain hose to the kit.

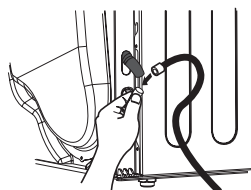

Leveling the Appliance

Leveling the appliance prevents unnecessary noise and vibration. Place the appliance on a solid, level floor.

If the appliance is not properly level, adjust the front leveling feet as necessary.

Turn them clockwise to raise and counter-clockwise to lower until the appliance no longer wobbles, both front-to-back and side-to-side and corner-to-corner.

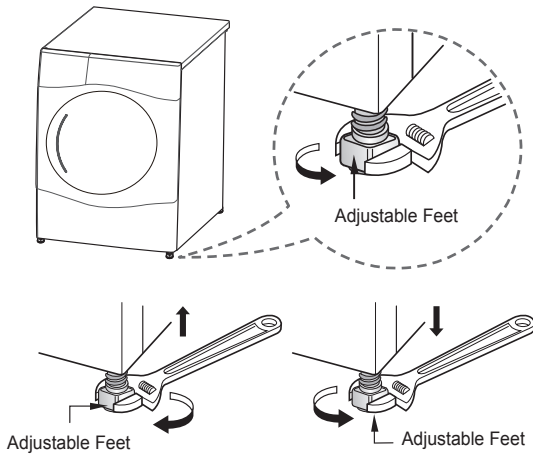

Diagonal Check

When pushing down the edges of the top plate diagonally, the appliance should not move up and down at all (Check both directions). If the appliance rocks when pushing the top plate diagonally, adjust the feet again.

OPERATION

Using the Appliance

Before the first cycle, set the appliance to dry for five minutes to warm up the drum. Open the door between loads the first few times you use the appliance to allow any odours from the interior of the appliance to disperse.

- 1 Ensure the lint filter and water container are clean.
 - The lint filter is inside the door rim. It needs to be cleaned before each drying cycle.
 - Open the door and ensure the lint filter is clean. If it is not, please clean the lint filter.

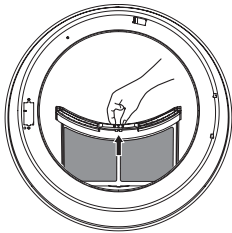

- Also check if the water container needs to be emptied for optimum drying results.

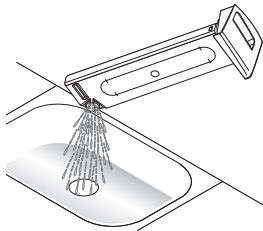

! WARNING

- Do not drink the condensed water.

NOTE

- In some instances, LED window may display  (Empty water symbol) and the appliance may stop because the water container is full.

- 2 Place laundry into the drum after sorting.
 - The clothes should be sorted by fabric type and dryness level and all the strings and belts of clothes should be well tied and fixed before being put into the drum. Push the laundry to the back to keep it away from the door seal. Otherwise, the door seal and clothes may be damaged. Close the door.

! CAUTION

- Be careful not to trap laundry between the door and rubber seal.

- 3 Turn the power on.
 - Press the **Power** button. The indicator icon above the button will become illuminated, indicating that the appliance is all set to run.



- 4 Select the drying programme you want.
 - You can choose a programme by turning the programme selector knob until the required programme is indicated.
 - If you press the **Start/Pause** button without choosing a programme, the appliance will proceed with the Cotton programme. Please refer to the programme table for the detailed information.

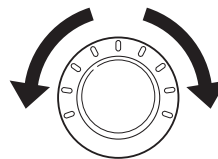

- 5 Press the **Start/Pause** button.



- 6 After the cycle has finished, open the door and remove the laundry.

- 7 Turn off the appliance.
 - Press the **Power** button.

CAUTION















- Be careful! The drum inside may still be hot.
- The appliance must not be used for purposes other than those for which it was designed.

NOTE

- The final part of a tumble dryer cycle occurs without heat (cool down cycle) to ensure that laundry is left at a temperature that ensures the laundry will not be damaged.
- A high atmospheric temperature and a small room may both increase drying time as well as energy consumption.

Sorting Laundry

Clothes have their own wash care labels, so drying according to the wash care label is recommended.

Symbols	Instructions
	Dry
	Tumble dry
	Permanent Press / Crease resistant
	Gentle / Delicate
	Do not tumble dry
	Do not dry
	High heating
	Medium heating
	Low heating
	No heat / air
	Line Dry / hang to dry
	Drip dry
	Dry flat
	In the shade

Not only that, the laundry must be sorted according to size and type of fabric.

For the best drying performance and most efficient energy usage, do not overload the appliance.

Woollens

Dry woollens on the Wool programme. Be sure to follow fabric care label symbols first. Wool may not be completely dried from the cycle, so do not repeat drying. Pull woollens to their original shape and dry them flat.

Woven and Loopknit Materials

Some woven and loopknit materials may shrink, depending on quality.

Permanent Press and Synthetics

Do not overload the appliance. Take out permanent press items as soon as the appliance stops to reduce creases.

Baby Clothes and Night Gowns

Always check fabric care labels.

Rubber and Plastics

Do not dry any items made from or containing rubber or plastics such as:

- Aprons, Bibs and Chair Covers
- Curtains and Table Clothes
- Bathmats

Fiberglass

Do not dry fiberglass items in the appliance. Glass particles left in the appliance may be subsequently picked up by your clothes in later cycles.

Control Panel

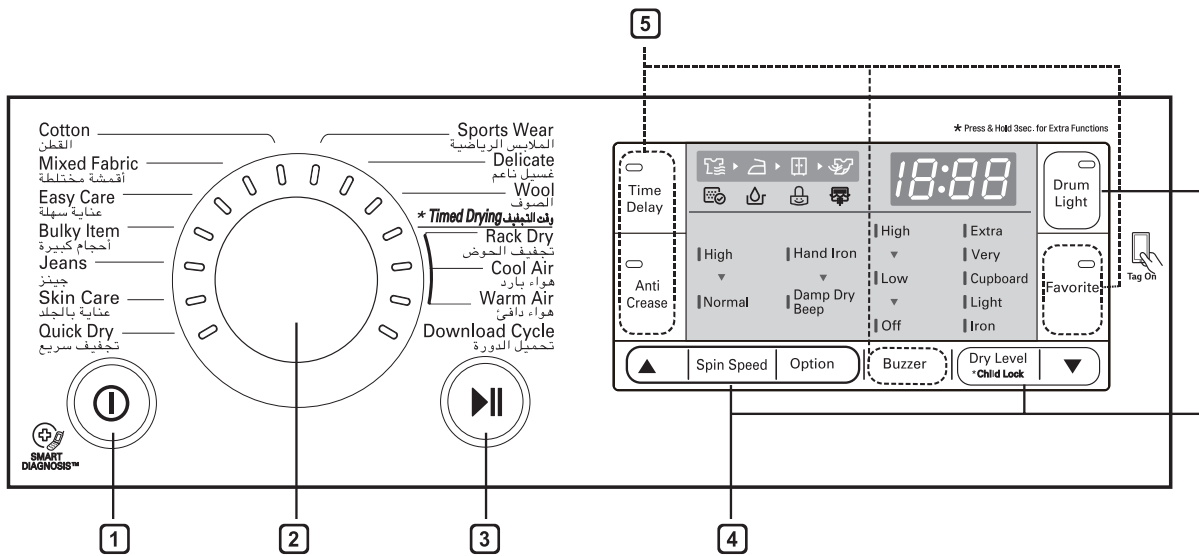

1 Power button

- Press the **Power** button to turn power on and off.
- Press the **Power** button to cancel the Time Delay function.

2 Programme Selector

- Programmes are available according to the laundry type.
- The lamp will light up to indicate the selected programme.

3 Start/Pause button

- This **Start/Pause** button is used to start or pause a dry cycle.
- Press the **Start/Pause** button to stop the cycle temporarily.
- When in Pause, the power is turned off automatically after four minutes.

4 Additional Programme buttons

- Use these buttons to select the desired options for the selected programme.

5 Options

- This allows you to select additional options and will illuminate when selected.

6 Display

- : This icon indicates that the lint filter should be cleaned or is clogged.
 - Cleaning notice: When you press the **Power** button, the icon will become displayed.
 - Clogging notice: This icon will become displayed with a buzzer sound whilst the appliance is in operation.
- : This icon indicates that the water container needs to be emptied or is full.
 - Emptying notice: When you press the **Power** button, this icon will become displayed.
 - Full water notice: The icon will become displayed and a buzzer will sound while the appliance is in operation.
- : This icon indicates that the condenser should be cleaned. If the icon is displayed, clean the condenser promptly.

Programme Table

Drying Programme

Sensor Dry Programmes			
Programme	Laundry Type	Detail	Drying Level
Cotton	Towels, dressing gowns and bed linen	For thick and quilted fabrics	Extra
	Terry towels, tea towels, towels and bed linen	For thick and quilted fabrics that do not need to be ironed	Very
	Bath towels, tea towels, underwear and cotton socks	For fabrics that do not need to be ironed	Cupboard
	Sheets, pillowcase and towels	For fabrics that do not need to be ironed	Light
	Bed linen, table linen, towels, T-shirts, polo shirts and work clothes	For fabrics that need to be ironed	Iron
Mixed Fabric	Bed linen, table linen, tracksuits, anoraks and blankets	For thick and quilted fabrics that do not need to be ironed	Very
	Shirts and blouses	For fabrics that do not need to be ironed	Cupboard
	Trousers, dressers, skirts and blouses	For fabrics that need to be ironed	Iron
Easy Care	Shirts, T-shirts, trousers, under-wear and socks	For polyamide, acrylic, and polyester that do not need to be ironed	Cupboard
	Shirts, T-shirts, under-wear, anoraks and socks	For polyamide, acrylic, polyester that do need to be ironed	Iron
Bulky Item	Bed clothes, sheets	For bulky items	-
Jeans	Jeans and colour fading garments.	For jeans which do not need to be ironed	-
Skin Care	T-shirts, pillowcase, and towels	For cotton fabrics which do not need to be ironed	-
Sports Wear	Soccer kit and training wear	For polyester material	-
Quick Dry	Linen and towels (excluding delicate fabrics) sports wear, bulky Item cycle.	For small loads of suitable fabrics with short drying times	-
Delicate	Silk, fine fabrics and lingerie	For fabrics that are heat-sensitive, such as synthetic fabrics	-
Wool	Wool	For wool fabrics	-

Timed Drying Programmes			
Programme	Laundry Type	Detail	Drying Level
Rack Dry	Silk, wool, delicate lingerie	Refreshes clothes without tumble drying	-
Cool Air	All fabrics that need refreshing	Tumbles without heat	-
Warm Air	Bath towels, bath robes, dishclothes and acrylic quilted fabrics	Small Items & damp clothing, Everyday items suitable for heat drying	-

Drying Guide

Programme (RC8066**F, RC8066*F - 8 kg)		Capacity of dryer	Display Drying Time (Including Cooling Time)	
			Normal	High
Cotton	Extra	8 kg	125 min	115 min
	Very	8 kg	120 min	110 min
	Cupboard	8 kg	115 min	105 min
	Light	8 kg	103 min	93 min
	Iron	8 kg	97 min	87 min
Mixed Fabric	Very	4 kg	53 min	43 min
	Cupboard	4 kg	48 min	38 min
	Iron	4 kg	41 min	31 min
Easy Care	Cupboard	4 kg	58 min	38 min
	Iron	4 kg	51 min	31 min
Bulky Item		2 kg	60 min	-
Jeans		3 kg	36 min	-
Skin Care		4.5 kg	118 min	-
Sports Wear		2 kg	24 min	-
Quick Dry		3 kg	50 min	-
Delicate		1.5 kg	45 min	-
Wool		1 kg	21 min	-

Programme (RC9066**F, RC9066**F - 9 kg)		Capacity of dryer	Display Drying Time (Including Cooling Time)	
			Normal	High
Cotton	Extra	9 kg	135 min	125 min
	Very	9 kg	130 min	120 min
	Cupboard	9 kg	125 min	115 min
	Light	9 kg	113 min	103 min
	Iron	9 kg	107 min	97 min
Mixed Fabric	Very	4.5 kg	58 min	48 min
	Cupboard	4.5 kg	53 min	43 min
	Iron	4.5 kg	46 min	36 min
Easy Care	Cupboard	4.5 kg	63 min	43 min
	Iron	4.5 kg	56 min	36 min
Bulky Item		2 kg	60 min	-
Jeans		3 kg	36 min	-
Skin Care		4.5 kg	118 min	-
Sports Wear		2 kg	24 min	-
Quick Dry		3 kg	50 min	-
Delicate		1.5 kg	45 min	-
Wool		1 kg	21 min	-

NOTE

- The test results depend on room temperature, type and amount of load, water hardness and water inlet temperature.
- If the appliance is installed as built under, it may cause performance degradation.
- If the laundry is not spun at a high speed during washing, energy consumption and drying time will increase.



CAUTION

- If the load is less than 1 kg, please use the **Warm Air** programme in Timed Drying programmes. Wool items should be dried using the **Wool** programme and heat-sensitive fabrics including silk, underwear and lingerie should be dried using the **Delicate** programme. Please comply with the recommended laundry load when you select your desired programme. Otherwise, your clothes may be damaged.

Option Cycle

Time Delay

You can use the Time Delay option to delay the finishing time of the drying cycle. Maximum Time Delay is 19 hours. Minimum Time Delay is 3 hours.

- 1 Turn the appliance on.
- 2 Select a programme.
- 3 Press the **Time Delay** button.
- 4 Set time delay hour(s) by pressing the ▲, ▼ button.
- 5 Press the **Start/Pause** button.

Anti Crease ()

The Anti Crease option prevents creases that are formed when the laundry is not unloaded promptly at the end of the drying cycle. When **Anti Crease** is selected, the appliance repeatedly runs and pauses, giving you two hours to unload the laundry. If the door is opened during the Anti Crease option, the option is cancelled.

Favorite

The Favorite option allows you to store a customized dry programme for future use.

- 1 Turn the appliance on.
- 2 Select a programme.
- 3 Select the option or additional programme.
(Anti Crease, Spin Speed etc.)
- 4 Press and hold the **Favorite** option button for three seconds.

The Favorite option is now stored for future use. To reuse the stored programme, select the **Favorite** option and press the **Start/Pause** button.

Drum Light

Whilst the appliance is running it is possible to see inside the drum if you select the **Drum Light** function.

- Light on : Door is opened.
- Light off : Door is closed. The light is turned off automatically.

Spin Speed

This additional program is able to control drying time, allowing you to select high or normal.

- The default option is Normal.

Option

Hand Iron

This function keeps the garments more moist than the standard Iron dry level.

- 1 Turn the appliance on.
- 2 Select a programme.
- 3 Press the **Dry level** button and select **Iron**.
- 4 Press the **Option** button and select **Hand Iron**.
- 5 Press the **Start/Pause** button.

Hand Iron is available to programmes specified in the table below.

Programme	Dry Level
Cotton	Iron
Mixed Fabric	
Easy Care	

Damp Dry Beep

With this option, the appliance will beep when the load is ready for ironing.

This allows you to remove faster-drying lightweight items or items that you would like to iron or hang while still slightly damp.

- 1 Turn the appliance on.
- 2 Select a programme.
- 3 Press the **Dry level** button and select a level.
- 4 Press the **Option** button and select **Damp Dry Beep**.
- 5 Press the **Start/Pause** button.
- 6 When the laundry is ready for ironing, the buzzer will sound for approximately one minute.
- 7 Press the **Start/Pause** button and open the door.
- 8 Take out laundry which you wish to iron. (Leave the other laundry in the appliance.)
- 9 Close the door and press the **Start/Pause** button.

Damp Dry Beep is available to programmes specified in the table below.

Programme	Dry Level
Cotton	Extra/Very Cupboard/Light
Mixed Fabric	Very/Cupboard
Easy Care	Cupboard

Child Lock ()

Select this function to lock the buttons on the control panel to prevent tampering.

Locking the control panel

- 1 Press and hold the **Child Lock** button for three seconds.



- 2 A beeper will sound, and **CL** will appear on the display.
When the **Child Lock** is set, all buttons are locked except the **Power** button.

NOTE

- Turning off the power will not reset the Child Lock function. You must deactivate child lock before you can access any other functions.

Unlocking the control panel

Press and hold the **Child Lock** button for three seconds.

- A beeper will sound and the remaining time for the current programme will reappear on the display.

Buzzer

This option enables you to adjust the volume of the beeper sound.

Rack Dry (Optional)

The dryer rack is placed inside the appliance, as in the picture below. Remove and discard packing material before use.

The Rack Dry is designed for use with laundry that must be dried flat, without tumbling, including sweaters and delicate fabrics.

- 1 Open the door.
- 2 Insert the hook to the drum centre.

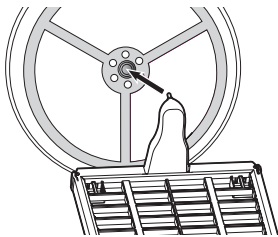

- 3 Place the dryer rack on the structure above the lint filter and press it to complete assembly.

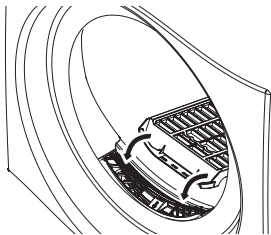

- 4 Place wet items on top of the rack. Allow space around items for air to circulate.
 - The rack does not move, but the drum will rotate.

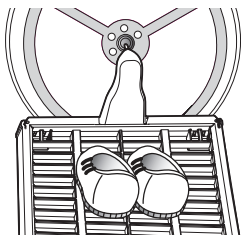

- 5 Close the door.
- 6 Turn power on and select **Rack Dry**.
- 7 Press the **Start/Pause** button.

NOTE

- Check the lint filter and remove any lint accumulated from items dried on the rack.

Using Smart Function (Optional)

Using the Tag On Function

The Tag On function allows you to conveniently use the LG Smart Diagnosis™ and Cycle Download features to communicate with your appliance right from your own smart phone.

- The Tag On function can only be used with most smart phones equipped with the NFC function and based on the Android operating system (OS).

Installation of the application

- Search LG Smart Laundry&DW Global on the Google Play Store from your smart phone.

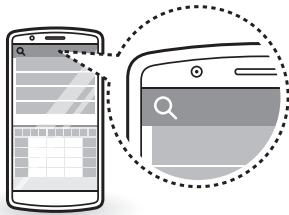

Using the Application

LG Smart Laundry&DW Global application allows you to use various features for your convenience.

- Cycle Download
- Smart Diagnosis™
- Tag On Cycle Set
- Laundry Stats

NOTE

- Press **?** in the LG Smart Laundry&DW Global application for a more detailed guide on how to use the Tag On function.
- Depending on the smart phone manufacturer and Android OS version, the NFC activation process may differ. Refer to the manual of your smart phone for details.
- Because of the characteristics of NFC, if the transmission distance is too far, or if there is a metal sticker or a protective case on the phone, transmission

will not be good. In some cases, NFC-equipped phones may be unable to transmit successfully.

- The content found in this manual may differ depending on the version of LG Smart Laundry&DW Global application, and it may be modified without customers being informed.

MAINTENANCE

WARNING

- Remove the power plug when you clean the appliance. Not removing the plug may result in electric shock.

Cleaning the Lint Filter

Clean the lint filter before each drying cycle. It should also be cleaned if the  icon becomes illuminated and the buzzer sounds while the appliance is in operation.

Cleaning the lint filter will reduce drying time and energy consumption.

- 1 Open the door.
- 2 Remove the lint filter.

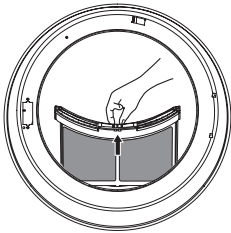

- 3 Open the lint filter and remove all the lint.

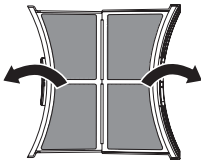

- 4 Rinse away the lint under warm, running water.

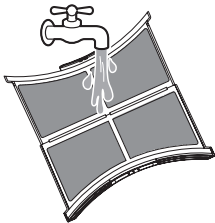

- 5 Dry the lint filter completely, close and reinsert the lint filter.

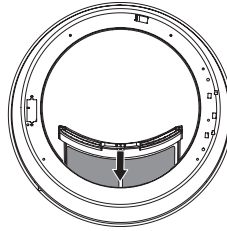

Note

- Remove moisture from the mesh. Otherwise, the lint filter may be clogged due to water film and the appliance may not operate.
- If the lint filter is not in the appliance, you can not operate the appliance.

Emptying the Water Container

Condensed water is collected in the water container. Empty the water container after every use. Not doing so will affect the drying performance.

If the water container is full, the  icon glows and the buzzer sounds while the appliance is operating. If this should occur, the water container needs to be emptied within the next hour.

- 1 Pull out the water container.

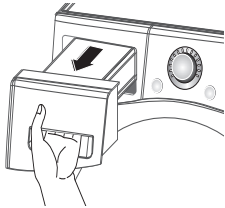

- 2 Empty the water container in the sink.

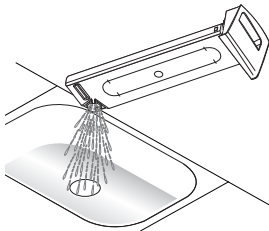

- 3 Push it back into the appliance.

- 4 Press the **Start/Pause** button.

Cleaning the Cool Air Inlet Grill

Vacuum the Cool Air Inlet grill 3 - 4 times a year to make sure there is no build up of lint or dirt that may cause improper air flow.

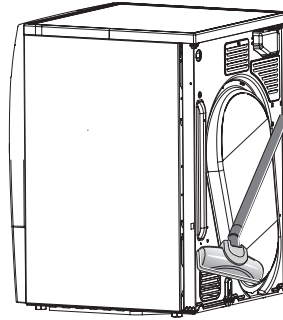

NOTE

- Warm air is exhausted through the ventilation grill.
- Adequate ventilation should be provided to avoid the back flow of gases into the room from units burning other fuels, such as open fires.

Wiping the Moisture Sensor

This device senses the moisture level of the laundry during operation, which means it must be cleaned regularly to remove any build up of lime scale on the surface of the sensor.

Wipe the sensors inside the drum.

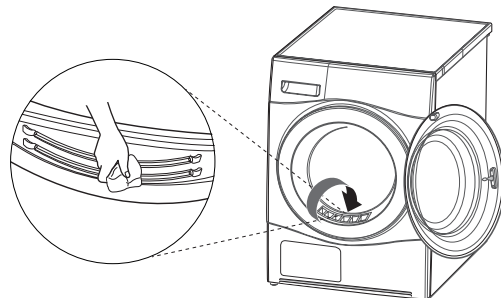

CAUTION

- Do not wipe the moisture sensor with abrasive materials. Always clean the sensor with a rough sponge.

Cleaning the Condenser

The condenser is also a very important part for efficient drying performance result, so it needs special care from you. It is recommended that the condenser be cleaned three or four times a year or when the  icon blinks.

- 1 Push the cap and open the condensing cover.

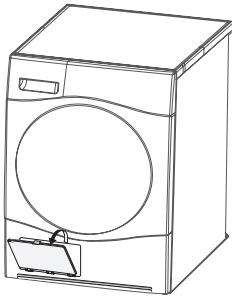

- 2 Open the seal by turning the locking lever.

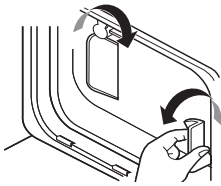

- 3 Pull the condenser out by inserting a finger into the tab at the front of the condenser. (Do not force the condenser).

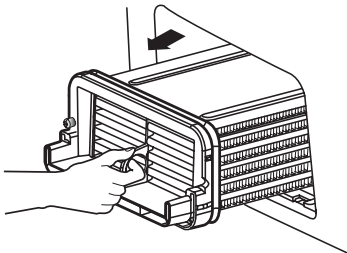

NOTE

- If the  icon is displayed, clean the condenser promptly.

- 4 Clean the condenser thoroughly under a tap, letting the water flow through.

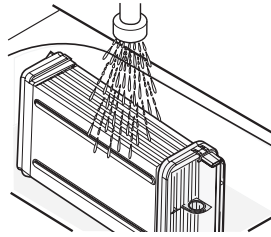
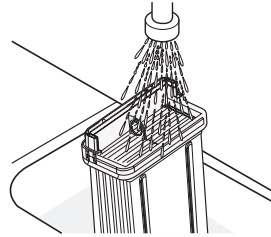

- 5 Put everything back together by following the instructions in reverse order.

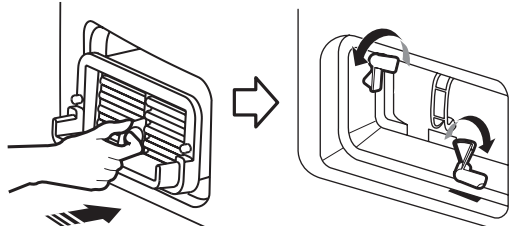

CAUTION

- The locking lever must be closed after cleaning the condenser as illustrated above.
- Operating when the condenser is clogged with lint can damage the appliance. This also increases energy consumption.
- Do not use sharp objects to clean the heat exchanger. This could cause damage and leaking.
- Never operate the appliance without the heat exchanger.

Using the Smart Diagnosis™ Function

Use this function if you need an accurate diagnosis by an LG Electronics Customer Information Centre when the product malfunctions or fails. Use this function only to contact the service representative, not during normal operation.

- 1 Press the **Power** button to turn on the appliance. Do not press any other buttons or turn the programme selector knob.
- 2 When instructed to do so by the call center, place the mouthpiece of your phone close to the Smart Diagnosis™ icon and **Power** button.

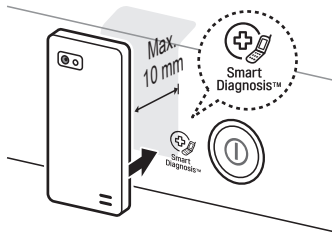

- 3 Press and hold the ▲ (More) button for three seconds, while holding the mouthpiece of your phone close to the Smart Diagnosis™ icon and **Power** button.
- 4 Keep the phone in place until the tone transmission has finished.

The display will count down the time.

- For best results, do not move the phone while the tones are being transmitted.
- If the call center agent is not able to get an accurate recording of the data, you may be asked to try again.

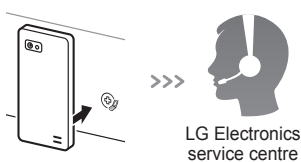

- 5 Once the countdown is over and the tones have stopped, resume your conversation with the call center agent, who will then be able to assist you using the information transmitted for analysis at the call to the LG Electronics Customer Information Centre.

NOTE

- The Smart Diagnosis™ function depends on the local call quality.
- The communication performance will improve and you can receive better service if you use a home phone.
- If the Smart Diagnosis™ data transfer is poor due to poor call quality, you may not receive the best Smart Diagnosis™ service.

TROUBLESHOOTING

The appliance is equipped with an automatic error-monitoring system to detect and diagnose problems at an early stage. If the appliance does not function properly or does not function at all, check the following before you call for service:

Diagnosing Problems

Symptoms	Reason	Solution
Appliance will not turn on	Power cord is not properly plugged in.	Make sure that the plug is securely plugged into a grounded outlet matching the appliance's rating plate.
	House fuse is blown, circuit breaker has tripped, or power outage has occurred.	Reset circuit breaker or replace fuse. Do not increase fuse capacity. If the problem is a circuit overload, have it corrected by a qualified electrician.
Appliance does not heat	House fuse is blown, circuit breaker has tripped, or power outage has occurred.	Reset circuit breaker or replace fuse. Do not increase fuse capacity. If the problem is a circuit overload, have it corrected by a qualified electrician.
Clothes take too long to dry	Load is not properly sorted.	Separate heavy items from lightweight items. Larger and heavier items take longer to dry. Light items in a load with heavy items can fool the sensor because the light items dry faster.
	Large load of heavy fabrics.	Heavy fabrics take longer to dry because they tend to retain more moisture. To help reduce and maintain more consistent drying times for large and heavy fabrics, separate these items into smaller loads of a consistent size.
	Appliance controls are not set properly.	Use the appropriate control settings for the type of load you are drying. Some loads may require an adjustment of the dry level setting for proper drying.
	Lint filter needs to be cleaned.	Remove the lint from the lint filter before every cycle. With the lint removed, hold the lint filter up to a light to see if it is dirty or clogged. With some loads that produce high amounts of lint, such as new bath towels, it may be necessary to pause the cycle and clean the filter during the cycle.

Symptoms	Reason	Solution
Clothes take too long to dry	House fuse is blown, circuit breaker has tripped, or power outage has occurred.	Reset circuit breaker or replace fuse. Do not increase fuse capacity. If the problem is a circuit overload, have it corrected by a qualified electrician.
	Appliance is overloaded.	Divide extra large loads into smaller loads for better drying performance and efficiency.
	Appliance is underloaded.	If you are drying a very small load, add a few extra items to ensure proper tumbling action. If the load is very small and you are using Sensor Dry programmes, the electronic control cannot properly sense the dryness of the load and may shut off too soon. Use Timed Drying programmes or add some extra wet clothes to the load.
Drying time is not consistent	Heat settings, load size, or dampness of clothing is not consistent.	The drying time for a load will vary depending on the type of heat used (electric), the size of the load, the type of fabrics, the wetness of the clothes, and lint filter. Even an unbalanced load in the appliance can cause poor spinning, resulting in wetter clothes which will take longer to dry.
Greasy or dirty spots are left on clothes	Fabric softener is used incorrectly.	When washing laundry that is to be dried in the appliance, use the correct amount of fabric softener as recommended by the manufacturer of the fabric softener.
	Clean and dirty clothes are being dried together.	Use the appliance to dry only clean items. Soil from dirty clothes can transfer to the clean clothes in the same or later loads.
	Clothes were not properly cleaned or rinsed before being placed in the appliance.	Stains on dried clothes could be stains that were not removed during the washing process. Make sure that clothes are being completely cleaned or rinsed according to the instructions for your washing machine and detergent. Some difficult soils may require pre-treating prior to washing.
Clothes are wrinkled	Clothes have dried too long (overdried).	Over drying a load of laundry can lead to wrinkled clothes. Try a shorter drying time.
	Clothes have been left in the appliance for too long after cycle ends.	Use the Anti crease option.

Symptoms	Reason	Solution
Clothes are shrinking	Garment care instructions are not being followed.	To avoid shrinking your clothes, always consult and follow fabric care instructions. Some fabrics will naturally shrink when washed. Other fabrics can be washed but will shrink when dried in the appliance. Use a low or no heat setting.
Lint is left on clothes	Lint filter has not been cleaned properly.	Remove the lint from the lint filter before every cycle. With the lint removed, hold the lint filter up to a light to see if it is dirty or clogged. If it looks dirty, follow the cleaning instructions. With some loads that produce high amounts of lint, it may be necessary to clean the lint filter during the cycle.
	Laundry has not been sorted properly.	Some fabrics are lint producers (i.e., a fuzzy white cotton towel) and should be dried separately from clothes that are lint trappers (i.e., a pair of black linen pants).
	Appliance is overloaded.	Divide extra large loads into smaller loads for drying.
	Tissue, paper, etc., has been left in pockets.	Check pockets thoroughly before drying clothes.
Excess static in clothes after drying	Clothes have dried for too long (overdried).	Overdrying a load of laundry can cause a buildup of static electricity. Adjust settings and use a shorter drying time, or use Sensor Dry programmes.
	Drying synthetics, permanent press, or synthetic blends.	These fabrics are naturally more prone to static buildup. Try using fabric softener, or use shorter Timed Drying time settings.
Water leaks	The water container hose or the drain hose is not connected correctly.	Connect the water container hose or the drain hose correctly.
	The door is closed while laundry or foreign substance is caught in the door.	Check if laundry or foreign substance is caught in the door before using the appliance. If water leaks continuously, contact the LG Electronics Customer Information Centre.

Symptoms	Reason	Solution
Clothes have damp spots after a Sensor Dry programme	Very large load or very small load. Single large item such as a blanket or comforter.	<p>If items are too tightly packed or too sparse the sensor may have trouble reading the dryness level of the load. Use a Timed Drying programme for very small loads.</p> <p>Large, bulky items such as blankets or comforters can sometimes wrap themselves into a tight ball of fabric. The outside layers will dry and register on the sensors, while the inner core remains damp. When drying a single bulky item, it may help to pause the cycle once or twice and rearrange the item to unwrap and expose any damp areas.</p> <p>To dry a few remaining damp items from a very large load or a few damp spots on a large item after a Sensor Dry programme has completed, empty the lint trap, then set a Timed Drying programme to finish drying the item(s).</p>

Error Codes

Symptoms	Reason	Solution
dE	The door has been opened while the appliance is in operation or the appliance is being operated without the door being closed properly.	<ul style="list-style-type: none"> • Close the door completely. • If dE is not released, call for service.
tE1	Temperature Sensor has malfunctioned.	Unplug the power plug and call for service.
tE3		

WARRANTY

THIS LIMITED WARRANTY DOES NOT COVER:

- Service trips to deliver, pick up, or install or repair the product; instruction to the customer on operation of the product; repair or replacement of fuses or correction of wiring or plumbing, or correction of unauthorized repairs/ installation.
- Failure of the product to perform during power failures and interruptions or inadequate electrical service.
- Damage caused by leaky or broken water pipes, frozen water pipes, restricted drain lines, inadequate or interrupted water supply or inadequate supply of air.
- Damage resulting from operating the Product in a corrosive atmosphere or contrary to the instructions outlined in the Product's owner's manual.
- Damage to the Product caused by accidents, pests and vermin, lightning, wind, fire, floods, or acts of God.
- Damage or failure caused by unauthorized modification or alteration, or if it is used for other than the intended purpose, or any water leakage where the unit was not properly installed.
- Damage or failure caused by incorrect electrical current, voltage, or plumbing codes, commercial or industrial use, or use of accessories, components, or consumable cleaning products that are not approved by LG.
- Damage caused by transportation and handling, including scratches, dents, chips, and/or other damage to the finish of your product, unless such damage results from defects in materials or workmanship and is reported within one (1) week of delivery.
- Damage or missing items to any display, open box, discounted, or refurbished Product.
- Products with original serial numbers that have been removed, altered, or cannot be readily determined. Model and Serial numbers, along with original retail sales receipt, are required for warranty validation.
- Increases in utility costs and additional utility expenses.
- Repairs when your Product is used in other than normal and usual household use (e.g. commercial use, in offices and recreational facilities) or contrary to the instructions outlined in the Product's owner's manual.
- Costs associated with removal of your Product from your home for repairs.
- The removal and reinstallation of the Product if it is installed in an inaccessible location or is not installed in accordance with published installation instructions, including LG's owner's and installation manuals.
- Damage resulting from misuse, abuse, improper installation, repair, or maintenance. Improper repair includes use of parts not approved or specified by LG.
- Noise or vibration that is considered LG normal, for example, water drain sound, spin sound or warning beeps.

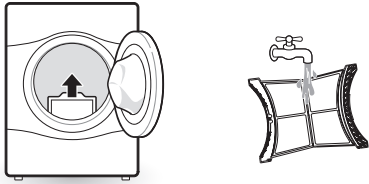
<p>Filter is clogged.</p> <ul style="list-style-type: none"> • Not heating, long dry time 			<ul style="list-style-type: none"> • Clean the lint filter.
<p>Improperly connected power cord or electrical outlet issue.</p> <ul style="list-style-type: none"> • No power • Not heating 			<ul style="list-style-type: none"> • Reconnect power cord, replace house fuse or reset breaker. If outlet is issue, electrician may be required.

Memo

