

⊕ : Depending on model / Abhängig vom Modell / Selon le modèle / In base al modello / En función del modelo / Dependendo do modelo / Afhankelijk van het model / Ανάλογα με το μοντέλο / Odvisno od modela / Típusfüggő / Zależnie od modelu / Závísí na modelu / V závislosti od modelu / În funcție de model / В зависимости от модели / Sõltub mudelist / Priklauso nuo modelio / Atkarībā no modeļa / U zavisnosti od modela / Ovisno o modelu / Në varësi të modelit / Ovisno o modelu / Bo zavisnost od modelot / Beroende på modell / Avhengig av modellen / Afhængigt af modellen / Mallin mukaan / حسب الطراز



www.lg.com

P/No: MFL69675032 (1704-REV01)
Printed in Korea



English	<ul style="list-style-type: none">• Read Safety and Reference.• For the power supply and power consumption, refer to the label attached to the product.	Magyar	<ul style="list-style-type: none">• Lásd: Biztonsági óvintézkedések.• A tápellátásra és az áramfogyasztásra vonatkozó adatok a készülékre ragasztott címkén találhatóak.
Deutsch	<ul style="list-style-type: none">• Sicherheitshinweise und Referenzen: Bitte lesen!• Informationen zur Stromversorgung und zum Stromverbrauch sind dem Etikett auf dem Gerät zu entnehmen.	Polski	<ul style="list-style-type: none">• Przeczytaj Zasady bezpieczeństwa i informacje dodatkowe.• Dokładne informacje o zasilaniu i zużyciu energii są umieszczone na etykiecie znajdującej się na produkcie.
Français	<ul style="list-style-type: none">• Lire le document Sécurité et référence.• Reportez-vous à l'étiquette apposée sur le téléviseur pour connaître l'alimentation et la consommation électriques.	Česky	<ul style="list-style-type: none">• Přečtěte si část Bezpečnost a reference.• Informace o napájení a příkonu naleznete na štítku připevněném k výrobku.
Italiano	<ul style="list-style-type: none">• Consultare la sezione Sicurezza e informazioni di riferimento.• Per l'alimentazione e il consumo di energia, consultare l'etichetta applicata sul prodotto.	Slovenčina	<ul style="list-style-type: none">• Prečítajte si časť Bezpečnosť a odkazy.• Informácie o zdroji napájania a spotrebe elektrickej energie nájdete na štítku pripojenom k zariadeniu.
Español	<ul style="list-style-type: none">• Leer Seguridad y Referencias.• Para obtener información acerca de la fuente de alimentación y el consumo de energía, consulte la etiqueta del producto.	Română	<ul style="list-style-type: none">• Citiți Siguranța și referințe.• Pentru sursa de alimentare și consumul de energie, consultați eticheta atașată pe produs.
Português	<ul style="list-style-type: none">• Consulte o manual de Segurança e Referência.• No que respeita à fonte de alimentação e ao consumo de energia, consulte a etiqueta mostrada no produto.	Български	<ul style="list-style-type: none">• Прочетете Безопасност и справки.• Направете справка с етикета на продукта за електрозахранването и консумацията на енергия.
Nederlands	<ul style="list-style-type: none">• Lees Veiligheid en referentie goed door.• Informatie over de stroomvoorziening en het stroomverbruik vindt u op het label op het product.	Eesti	<ul style="list-style-type: none">• Lugege jaotist Ohutus ja viited.• Toiteallika ja energiatarbe kohta saate teavet tootele kinnitatud märgiselt.
Ελληνικά	<ul style="list-style-type: none">• Ανάγνωση Ασφάλεια και Αναφορά.• Για πληροφορίες σχετικά με την τροφοδοσία και την κατανάλωση ενέργειας, δείτε την ετικέτα του προϊόντος.	Lietuvių k.	<ul style="list-style-type: none">• Perskaitykite Saugumas ir nuorodos.• Informacijos apie maitinimą ir energijos sąnaudas rasite etiketėje ant gaminio.
Slovenščina	<ul style="list-style-type: none">• Preberite Varnostne informacije in napotki.• Podatke o napajanju in porabi energije si oglejte na nalepki izdelka.	Latviešu	<ul style="list-style-type: none">• Izlasiet Drošībai un uziņai.• Informāciju par elektroenerģijas padevi un patēriņu skatiet izstrādājuma pievienotajā etiķetē.
		Srpski	<ul style="list-style-type: none">• Pročitajte Bezbednost i informacije.• Da biste saznali informacije u vezi sa napajanjem i potrošnjom energije, pogledajte oznaku na proizvodu.

**Hrvatski**

- Pročitajte **Sigurnost i reference**.
- Informacije o napajanju i potrošnji energije potražite na oznaci koja se nalazi na proizvodu.

Shqip

- Lexo **Siguria dhe referencat**.
- Për ushqimin me energji dhe konsumin e energjisë, shih etiketën e ngjitur në produkt.

Bosanski

- Pročitajte **Sigurnost i upućivanje**.
- Informacije o napajanju električnom energijom i potrošnji električne energije možete pronaći na naljepnici koja se nalazi na proizvodu.

Македонски

- Прочитајте во **Безбедносни информации и референтни материјали**.
- За напојувањето и потрошувачката на енергија, погледнете ја етикетата која е прикачена на производот.

- قراءة الأمان والمرجع .
 - لمعرفة المزيد حول مصدر الإمداد بالطاقة المطلوب ومعايير استهلاك الطاقة، راجع الملصق الموجود على المنتج .
- العربية

Svenska

- Läs **Säkerhet och referens**.
- För strömförsörjning och strömförbrukning, se etiketten på produkten.

Norsk

- Les **Sikkerhet og referanse**.
- Hvis du vil ha informasjon om strømforsyning og strømförbruk, kan du se på etiketten som er festet på produktet.

Dansk

- Læs **Sikkerhed og Reference**.
- Du kan få oplysninger om strømforsyning og strømförbrug på mærket, der sidder på produktet.

Suomi

- Lue **Turvatoimet ja viittaukset**.
- Tietoja virtalähteestä ja virrankulutuksesta on laitteeseen kiinnitetyssä tarrassa.

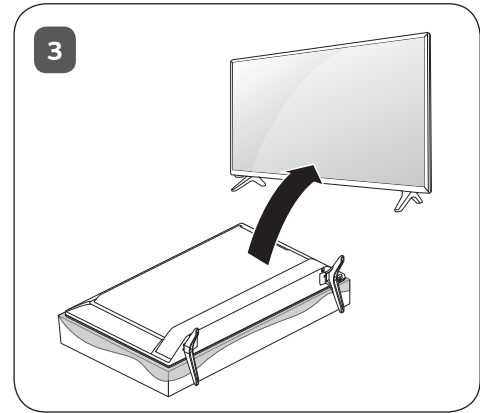
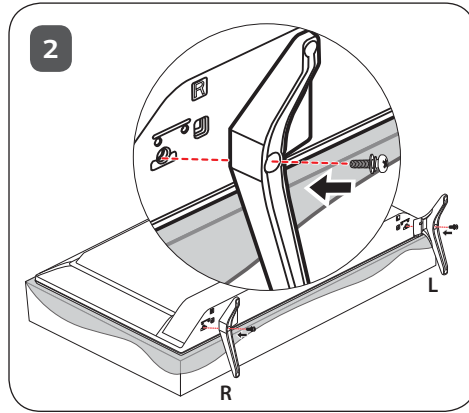
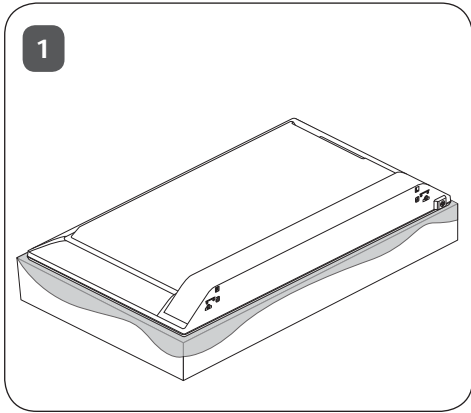

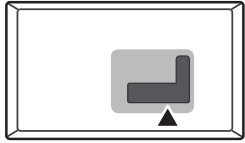

ANTENNA/
CABLE IN



HDMI IN



USB IN



+

LAN

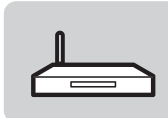

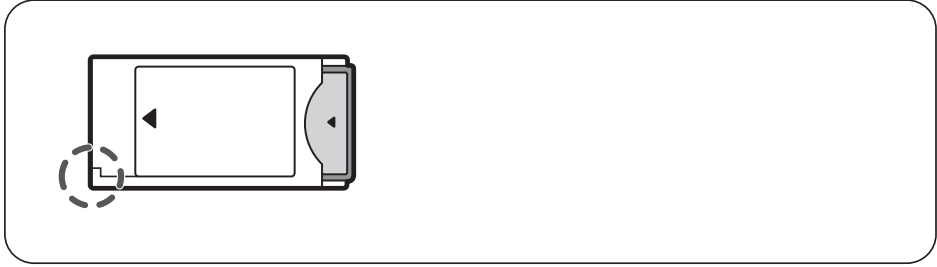
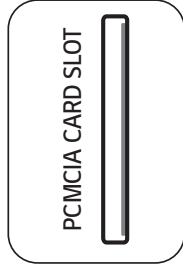
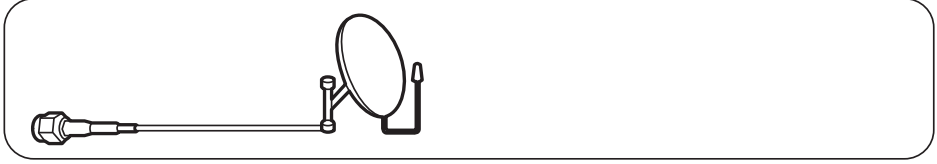
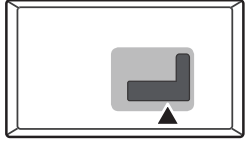

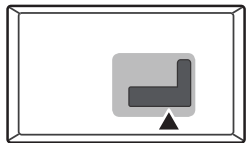

COMPONENT IN

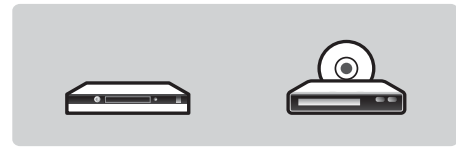
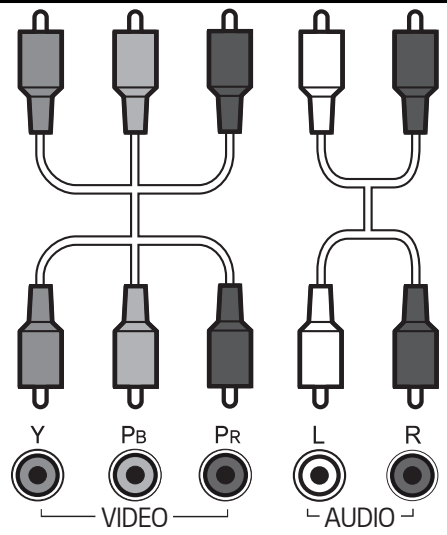
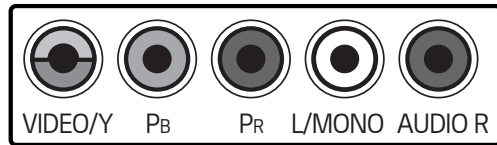

AV IN

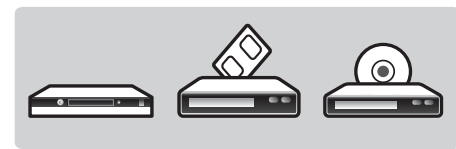
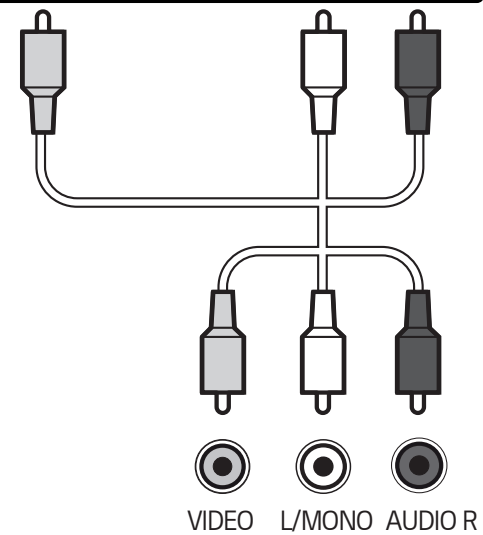
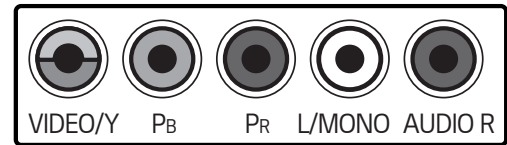

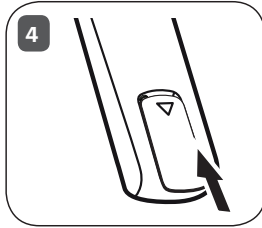
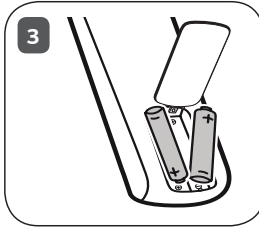
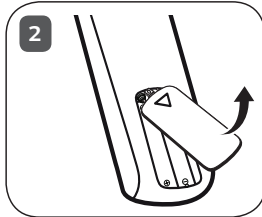
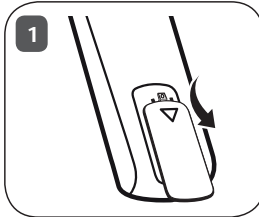
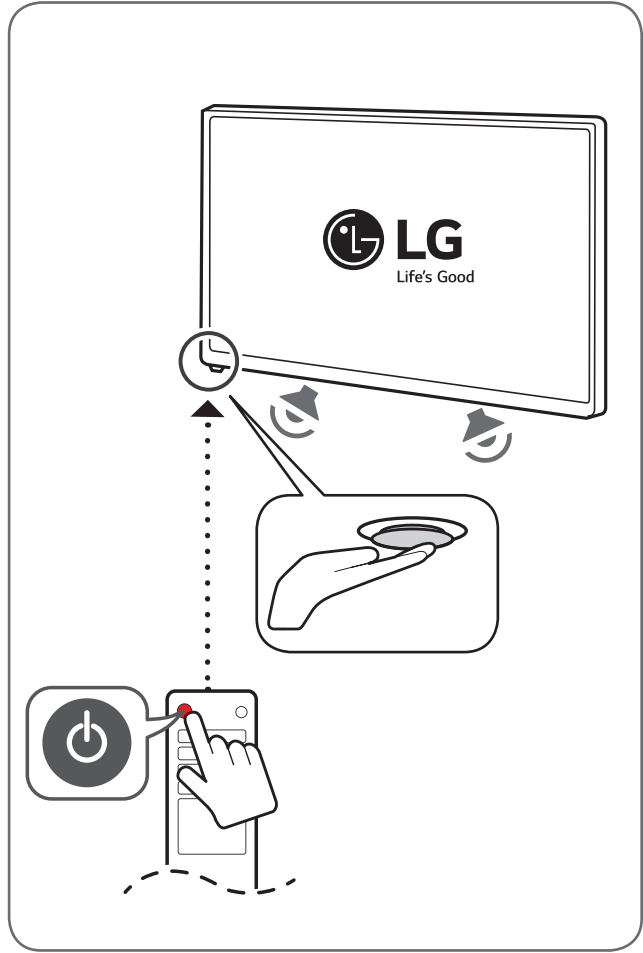
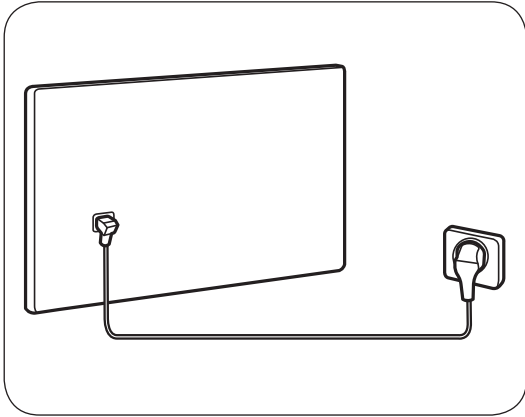

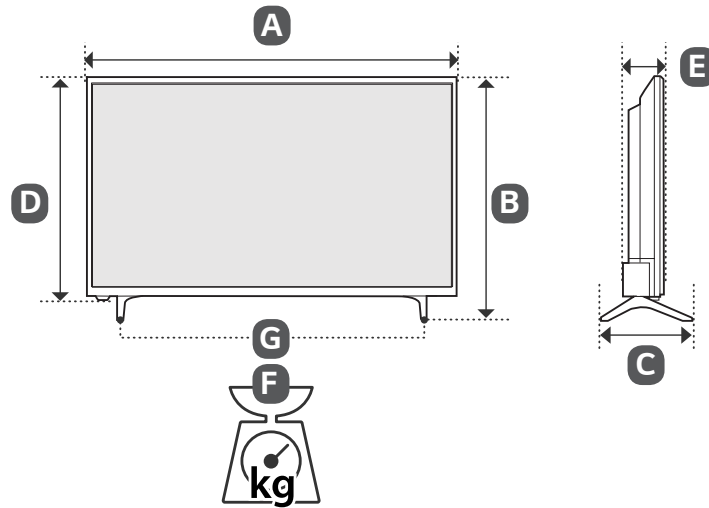

	A (mm)	B (mm)	C (mm)	D (mm)	E (mm)	F (kg)	F - G (kg)
32LJ500U-ZB	732	478	182.4	438	77.8	5.1	5.0
32LJ500V-ZB	728	475	182.4	436	77.8	5.0	4.9
43LJ500V-ZB	970	624	219.5	569	77.8	8.4	8.3
28MT42VF-PZ	635	427	182.4	387	77.8	4.1	4.0
Power requirement					AC 100-240 V~ 50/60 Hz		





* M F L 6 9 6 7 5 0 3 2 *





OWNER'S MANUAL

Safety and Reference

LED TV*

* LG LED TV applies LCD screen with LED backlights.

Please read this manual carefully before operating your set and retain it for future reference.



www.lg.com
P/NO : MFL69655102 (1612-REV00)
Printed in Korea

Warning! Safety instructions

ENGLISH



CAUTION : TO REDUCE THE RISK OF ELECTRIC SHOCK, DO NOT REMOVE COVER (OR BACK). NO USER-SERVICEABLE PARTS INSIDE. REFER TO QUALIFIED SERVICE PERSONNEL.

 This symbol is intended to alert the user to the presence of uninsulated "dangerous voltage" within the product's enclosure that may be of sufficient magnitude to constitute a risk of electric shock to persons.

 This symbol is intended to alert the user to the presence of important operating and maintenance (servicing) instructions in the literature accompanying the appliance.

WARNING : TO REDUCE THE RISK OF FIRE AND ELECTRIC SHOCK, DO NOT EXPOSE THIS PRODUCT TO RAIN OR MOISTURE.



TO PREVENT THE SPREAD OF FIRE, KEEP CANDLES OR OTHER ITEMS WITH OPEN FLAMES AWAY FROM THIS PRODUCT AT ALL TIMES.

- Do not place the TV and/or remote control in the following environments:
 - A location exposed to direct sunlight
 - An area with high humidity such as a bathroom
 - Near any heat source such as stoves and other devices that produce heat
 - Near kitchen counters or humidifiers where they can easily be exposed to steam or oil
 - An area exposed to rain or wind
 - Near containers of water such as vasesOtherwise, this may result in fire, electric shock, malfunction or product deformation.
- Do not place the product where it might be exposed to dust. This may cause a fire hazard.
- Mains Plug is the TV connecting/disconnecting device to AC mains electric supply. This plug must remain readily attached and operable when TV is in use.
- Do not touch the power plug with wet hands. Additionally, if the cord pin is wet or covered with dust, dry the power plug completely or wipe dust off. You may be electrocuted due to excess moisture.
- Make sure to connect Mains cable to compliant AC mains socket with Grounded earth pin. (Except for devices which are not grounded on earth.) Otherwise possibility you may be electrocuted or injured.
- Insert power cable plug completely into wall socket otherwise if not secured completely into socket, fire ignition may break out.
- Ensure the power cord does not come into contact with hot objects such as a heater. This may cause a fire or an electric shock hazard.
- Do not place a heavy object, or the product itself, on power cables. Otherwise, this may result in fire or electric shock.
- Bend antenna cable between inside and outside building to prevent rain from flowing in. This may cause water damaged inside the Product and could give an electric shock.
- When mounting TV onto wall make sure to neatly install and isolate cabling from rear of TV as to not create possibility of electric shock /fire hazard.
- Do not plug too many electrical devices into a single multiple electrical outlet. Otherwise, this may result in fire due to over-heating.
- Do not drop the product or let it fall over when connecting external devices. Otherwise, this may result in injury or damage to the product.
- Keep the anti-moisture packing material or vinyl packing out of the reach of children. Anti-moisture material is harmful if swallowed. If swallowed by mistake, force the patient to vomit and visit the nearest hospital. Additionally, vinyl packing can cause suffocation. Keep it out of the reach of children.
- Do not let your children climb or cling onto the TV. Otherwise, the TV may fall over, which may cause serious injury.
- Dispose of used batteries carefully to ensure that a small child does not consume them. Please seek Doctor- Medical Attention immediately if child consumes batteries.
- Do not insert any metal objects/conductors (like a metal chopstick/cutlery/screwdriver) into the end of power cable while the power plug is plugged into wall socket. Additionally, do not touch the power plug right after unplugging from the wall socket. You may be electrocuted.
- Do not put or store inflammable substances near the product. There is a danger of combustion/explosion or fire due to careless handling of the inflammable substances.

- Do not drop metallic objects such as coins, hair pins, chopsticks or wire into the product, or inflammable objects such as paper and matches. Children must pay particular attention. Electrical shock, fire or injury can occur. If a foreign object is dropped into the product, unplug the power cord and contact the service centre.
- Do not spray water on the product or scrub with an inflammable substance (thinner or benzene). Fire or electric shock accident can occur.
- Do not allow any impact, shock or any objects to fall into the unit, and do not drop anything onto the screen. You may be injured or the product can be damaged.
- Never touch this product or antenna during a thunder or lightning storm.
You may be electrocuted.
- Never touch the wall outlet when there is leakage of gas, open the windows and ventilate. It may cause a fire or a burn by a spark.
- Do not disassemble, repair or modify the product at your own discretion. Fire or electric shock accident can occur.
Contact the service centre for check, calibration or repair.
- If any of the following occur, unplug the product immediately and contact your local service centre.
 - The product has been damaged
 - Foreign objects have entered the product
 - The product produced smoke or a strange smell
 This may result in fire or electric shock.
- Unplug the TV from AC mains wall socket if you do not intend to use the TV for a long period of time. Accumulated dust can cause fire hazard and insulation deterioration can cause electric leakage/shock/fire.
- Apparatus shall not be exposed to dripping or splashing and no objects filled with liquids, such as vases, shall be placed on the apparatus.
- Do not install this product on a wall if it could be exposed to oil or oil mist. This may damage the product and cause it to fall.
- If water enters or comes into contact with TV, AC adapter or power cord please disconnect the power cord and contact service centre immediately. Otherwise, this may result in electric shock or fire.
- Only use an authorized AC adapter and power cord approved by LG Electronics. Otherwise, this may result in fire, electric shock, malfunction or product deformation.
- Never Disassemble the AC adapter or power cord. This may result in fire or electric shock.
- Be careful in handling the adapter to prevent any external shocks to it. An external shock may cause damage to the adapter.
- Make sure the power cord is connected securely to the power plug on the TV.
- Install the product where no radio wave occurs.
- There should be enough distance between an outside antenna and power lines to keep the former from touching the latter even when the antenna falls. This may cause an electric shock.
- Do not install the product on places such as unstable shelves or inclined surfaces. Also avoid places where there is vibration or where the product cannot be fully supported. Otherwise, the product may fall or flip over, which may cause injury or damage to the product.
- If you install the TV on a stand, you need to take actions to prevent the product from overturning. Otherwise, the product may fall over, which may cause injury.
- If you intend to mount the product to a wall, attach VESA standard mounting interface (optional parts) to the back of the product. When you install the set to use the wall mounting bracket (optional parts), fix it carefully so as not to drop.
- Only use the attachments / accessories specified by the manufacturer.
- When installing the antenna, consult with a qualified service technician. If not installed by a qualified technician, this may create a fire hazard or an electric shock hazard.
- We recommend that you maintain a distance of at least 2 to 7 times the diagonal screen size when watching TV. If you watch TV for a long period of time, this may cause blurred vision.
- Only use the specified type of battery. This could cause damage to the remote control.
- Do not mix new batteries with old batteries. This may cause the batteries to overheat and leak.
- Batteries should not be exposed to excessive heat. For example, keep away from direct Sunlight, open fireplace and electric heaters.
- Signal from Remote Control can be interrupted due to external/ internal lighting eg Sunlight, fluorescent lighting. If this occurs turn off lighting or darken viewing area.
- When connecting external devices such as video game consoles, make sure the connecting cables are long enough. Otherwise, the product may fall over, which may cause injury or damage the product.
- Do not turn the product On/Off by plugging-in or unplugging the power plug to the wall outlet. (Do not use the power plug for switch.) It may cause mechanical failure or could give an electric shock.

- Please follow the installation instructions below to prevent the product from overheating.
 - The distance between the product and the wall should be more than 10 cm.
 - Do not install the product in a place with no ventilation (e.g., on a bookshelf or in a cupboard).
 - Do not install the product on a carpet or cushion.
 - Make sure the air vent is not blocked by a tablecloth or curtain. This may result in fire.
 - Take care not to touch the ventilation openings when watching the TV for long periods as the ventilation openings may become hot. This does not affect the operation or performance of the product.
 - Periodically examine the cord of your appliance, and if its appearance indicates damage or deterioration, unplug it, discontinue use of the appliance, and have the cord replaced with an exact replacement part by an authorized servicer.
 - Prevent dust collecting on the power plug pins or outlet. This may cause a fire hazard.
 - Protect the power cord from physical or mechanical abuse, such as being twisted, kinked, pinched, closed in a door, or walked upon. Pay particular attention to plugs, wall outlets, and the point where the cord exits the appliance.
 - Do not press strongly upon the panel with a hand or sharp object such as nail, pencil or pen, or make a scratch on it, as it may cause damage to screen.
 - Avoid touching the screen or holding your finger(s) against it for long periods of time. Doing so may produce some temporary or permanent distortion/damage to screen.
 - As long as this unit is connected to the AC wall outlet, it is not disconnected from the AC power source even if you turn off this unit by SWITCH.
 - When unplugging the cable, grab the plug and unplug it, by pulling at the plug. Don't pull at the cord to unplug the power cord from the power board, as this could be hazardous.
 - When moving the product, make sure you turn the power off first. Then, unplug the power cables, antenna cables and all connecting cables.
- The TV set or power cord may be damaged, which may create a fire hazard or cause electric shock.

- When moving or unpacking the product, work in pairs because the product is heavy. Otherwise, this may result in injury.
- Refer all servicing to qualified service personnel. Servicing is required when the apparatus has been damaged in any way, such as power supply cord or plug is damaged, liquid has been spilled or objects have fallen into the apparatus, the apparatus has been exposed to rain or moisture, does not operate normally, or has been dropped.
- Do not use high voltage electrical goods near the TV (e.g. electric mosquito-swatter). This may result in product malfunction.
- When cleaning the product and its components, unplug the power first and wipe it with a soft cloth. Applying excessive force may cause scratches or discolouration. Do not spray with water or wipe with a wet cloth. Never use glass cleaner, car or industrial shiner, abrasives or wax, benzene, alcohol etc., which can damage the product and its panel. Otherwise, this may result in fire, electric shock or product damage (Deformation, corrosion or breakage).

Preparing

- Image shown may differ from your TV.
- Your TV's OSD (On Screen Display) may differ slightly from that shown in this manual.
- The available menus and options may differ from the input source or product model that you are using.
- New features may be added to this TV in the future.
- The items supplied with your product may vary depending on the model.
- Product specifications or contents of this manual may be changed without prior notice due to upgrade of product functions.
- For an optimal connection, HDMI cables and USB devices should have bezels less than 10 mm thick and 18 mm width. Use an extension cable that supports USB 2.0 if the USB cable or USB memory stick does not fit into your TV's USB port.

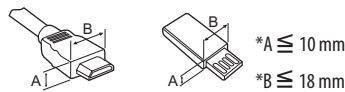

- Use a certified cable with the HDMI logo attached.
- If you do not use a certified HDMI cable, the screen may not display or a connection error may occur. (Recommended HDMI Cable Types)
 - High-Speed HDMI^{®/TM} cable (3 m or less)
 - High-Speed HDMI^{®/TM} cable with Ethernet (3 m or less)



- Do not use any unapproved items to ensure the safety and product life span.
- Any damage or injuries caused by using unapproved items are not covered by the warranty.
- Some models have a thin film attached on to the screen and this must not be removed.
- When attaching the stand to the TV set, place the screen facing down on a cushioned table or flat surface to protect the screen from scratches.
- Make sure that the screws are inserted correctly and fastened securely. (If they are not fastened securely enough, the TV may tilt forward after being installed.) Do not use too much force and over tighten the screws; otherwise screw may be damaged and not tighten correctly.

Lifting and moving the TV

Please note the following advice to prevent the TV from being scratched or damaged and for safe transportation regardless of its type and size.

- It is recommended to move the TV in the box or packing material that the TV originally came in.
- Before moving or lifting the TV, disconnect the power cord and all cables.
- When holding the TV, the screen should face away from you to avoid damage.



- Hold the top and bottom of the TV frame firmly. Make sure not to hold the transparent part, speaker, or speaker grill area.

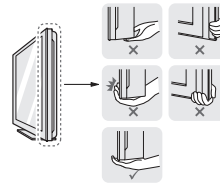

- When transporting a large TV, there should be at least 2 people.
- When transporting the TV by hand, hold the TV as shown in the following illustration.

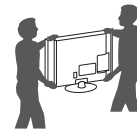

- When transporting the TV, do not expose the TV to jolts or excessive vibration.
- When transporting the TV, keep the TV upright, never turn the TV on its side or tilt towards the left or right.
- Do not apply excessive pressure to cause flexing / bending of frame chassis as it may damage screen.
- When handling the TV, be careful not to damage the protruding buttons.



- Avoid touching the screen at all times, as this may result in damage to the screen.
- Do not move the TV by holding the cable holders, as the cable holders may break, and injuries and damage to the TV may occur.

Using the button

(Depending on model)

You can simply operate the TV functions, using the button.

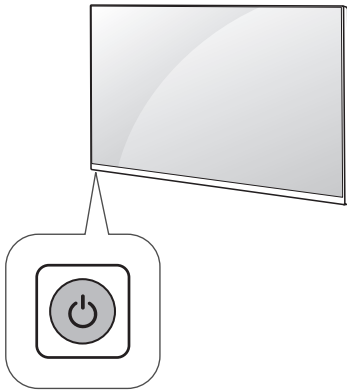

Mounting on a table

1 Lift and tilt the TV into its upright position on a table.

- Leave a 10 cm (minimum) space from the wall for proper ventilation.

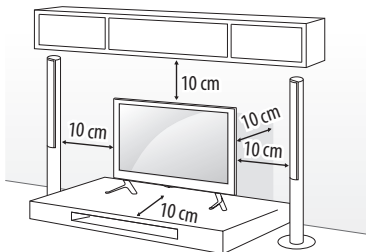

2 Connect the power cord to a wall outlet.



- Do not place the TV near or on sources of heat, as this may result in fire or other damage.
- Do not apply foreign substances (oils, lubricants, etc.) to the screw parts when assembling the product. (Doing so may damage the product.)

Securing the TV to a wall

(This feature is not available for all models.)

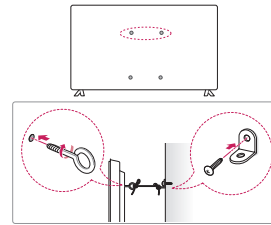

1 Insert and tighten the eye-bolts, or TV brackets and bolts on the back of the TV.

- If there are bolts inserted at the eye-bolts position, remove the bolts first.

2 Mount the wall brackets with the bolts to the wall.

- Match the location of the wall bracket and the eye-bolts on the rear of the TV.

3 Connect the eye-bolts and wall brackets tightly with a sturdy rope. Make sure to keep the rope horizontal with the flat surface.



- Make sure that children do not climb on or hang on the TV.

- Use a platform or cabinet that is strong and large enough to support the TV securely.
- Brackets, bolts and ropes are not provided. You can obtain additional accessories from your local dealer.

Mounting on a wall

Attach an optional wall mount bracket at the rear of the TV carefully and install the wall mount bracket on a solid wall perpendicular to the floor. When you attach the TV to other building materials, please contact qualified personnel. LG recommends that wall mounting be performed by a qualified professional installer. We recommend the use of LG's wall mount bracket. LG's wall mount bracket is easy to move with cables connected. When you do not use LG's wall mount bracket, please use a wall mount bracket where the device is adequately secured to the wall with enough space to allow connectivity to external devices. It is advised to connect all the cables before installing fixed wall mounts.

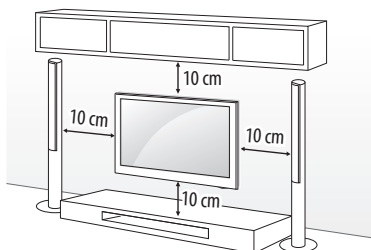

Make sure to use screws and wall mount bracket that meet the VESA standard. Standard dimensions for the wall mount kits are described in the following table.

Separate purchase (Wall mounting bracket)

Model	32LJ50**	43LJ50**
VESA (A x B) (mm)	100 x 100	200 x 200
Standard screw	M4	M6
Number of screws	4	4
Wall mount bracket	LSW140B	LSW240B MSW240
Model	28MT42**	
VESA (A x B) (mm)	100 x 100	
Standard screw	M4	
Number of screws	4	
Wall mount bracket	RW120	

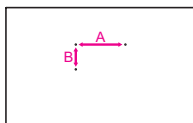

- Remove the stand before installing the TV on a wall mount by performing the stand attachment in reverse.
- Screw length from outer surface of back cover should be under 8 mm. (Only 28MT42**)

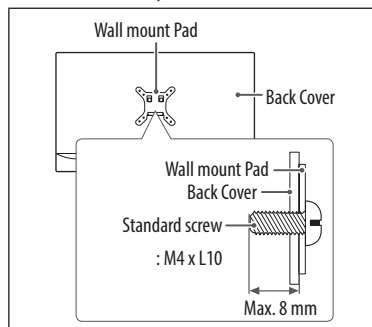

Connections (notifications)

Connect various external devices to the TV and switch input modes to select an external device. For more information of external device's connection, refer to the manual provided with each device.

Available external devices are: HD receivers, DVD players, VCRs, audio systems, USB storage devices, PC, gaming devices, and other external devices.

- The external device connection may differ from the model.
- Connect external devices to the TV regardless of the order of the TV port.
- If you record a TV program on a DVD recorder or VCR, make sure to connect the TV signal input cable to the TV through a DVD recorder or VCR. For more information of recording, refer to the manual provided with the connected device.
- Refer to the external equipment's manual for operating instructions.
- If you connect a gaming device to the TV, use the cable supplied with the gaming device.
- In PC mode, there may be noise associated with the resolution, vertical pattern, contrast or brightness. If noise is present, change the PC output to another resolution, change the refresh rate to another rate or adjust the brightness and contrast on the PICTURE menu until the picture is clear.
- In PC mode, some resolution settings may not work properly depending on the graphics card.

Antenna connection

Connect the TV to a wall antenna socket with an RF cable (75 Ω).

- Use a signal splitter to use more than 2 TVs.
- If the image quality is poor, install a signal amplifier properly to improve the image quality.
- If the image quality is poor with an antenna connected, try to realign the antenna in the correct direction.
- An antenna cable and converter are not supplied.
- Supported DTV Audio:
MPEG,
Dolby Digital / Dolby Digital Plus (32 kHz, 44.1 kHz, 48 kHz),
HE-AAC

Satellite dish connection

(Only satellite models)

Connect the TV to a satellite dish to a satellite socket with a satellite RF cable (75 Ω).

CI module connection

(Depending on model)

View the encrypted (pay) services in digital TV mode.

- Check if the CI module is inserted into the PCMCIA card slot in the right direction. If the module is not inserted properly, this can cause damage to the TV and the PCMCIA card slot.
- If the TV does not display any video and audio when CI+ CAM is connected, please contact to the Terrestrial/Cable/Satellite Service Operator.

Other connections

Connect your TV to external devices. For the best picture and audio quality, connect the external device and the TV with the HDMI cable. Some separate cable is not provided.

- Supported HDMI Audio format :
AC-3 (Max bit rate : 640 Kbps),
Dolby Digital / Dolby Digital Plus (32 kHz, 44.1 kHz, 48 kHz),
PCM (48 KHz , 44.1 KHz , 32 KHz)
(Depending on model)

Remote control

(Depending on model)

The descriptions in this manual are based on the buttons on the remote control. Please read this manual carefully and use the TV correctly.

To replace batteries, open the battery cover, replace batteries (1.5 V AAA) matching the (+) and (-) ends to the label inside the compartment, and close the battery cover. To remove the batteries, perform the installation actions in reverse.

Make sure to point the remote control toward the remote control sensor on the TV.

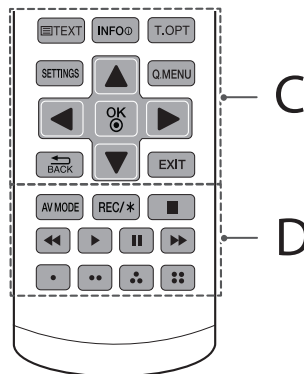

ENGLISH

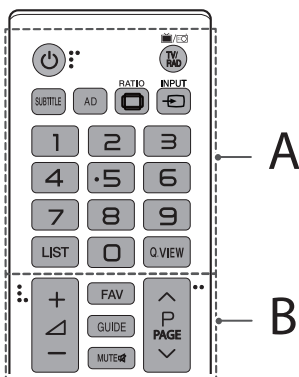

C

Teletext buttons (≡ **TEXT**, **T.OPT**) These buttons are used for teletext.

INFO ⓘ Views the information of the current programme and screen.

SETTINGS Accesses the Settings menu.

Q.MENU Accesses the Quick menus.

Navigation buttons (up/down/left/right) Scrolls through menus or options.

OK ⓘ Selects menus or options and confirms your input.

BACK ⏪ Returns to the previous level.

EXIT Clears on-screen displays and returns to TV viewing.

D

AV MODE Selects an AV mode.

REC/* This function is not supported.

Control buttons (■, ▶, II, ◀, ►) Controls media contents.

● ● ● ● These access special functions in some menus.

A

POWER ⏻ Turns the TV on or off.

TV/RAD 📺/📻 Selects Radio, TV and DTV programme.

SUBTITLE Recalls your preferred subtitle in digital mode.

AD Audio descriptions will be enabled. (Depending on model)

RATIO 📐 Resizes an image.

INPUT 📺 Changes the input source.

Number buttons Enters numbers.

LIST Accesses the saved programme list.

Q.VIEW Returns to the previously viewed programme.

B

Volume control +/− Adjusts the volume level.

FAV Accesses your favourite programme list.

GUIDE Shows programme guide.

MUTE 🔇 Mutes all sounds.

P/PAGE ⏪/⏩ Scrolls through the saved programmes.

PAGE ⏪/⏩ Moves to the previous or next screen.

Licenses

Supported licenses may differ by model. For more information about licenses, visit www.lg.com.

DOLBY AUDIO™

Manufactured under license from Dolby Laboratories. Dolby, Dolby Vision, Dolby Audio, and the double-D symbol are trademarks of Dolby Laboratories.



The terms HDMI and HDMI High-Definition Multimedia Interface, and the HDMI logo are trademarks or registered trademarks of HDMI Licensing LLC in the United States and other countries.

Open source software notice information

To obtain the source code under GPL, LGPL, MPL and other open source licenses, that is contained in this product, please visit <http://opensource.lge.com>.

In addition to the source code, all referred license terms, warranty disclaimers and copyright notices are available for download.

LG Electronics will also provide open source code to you on CD-ROM for a charge covering the cost of performing such distribution (such as the cost of media, shipping, and handling) upon email request to opensource@lge.com. This offer is valid for three (3) years from the date on which you purchased the product.

Settings

Automatically Setting Up Programme

SETTINGS ⇨ SETUP ⇨ Auto Tuning

Automatically tunes the programmes.

- If Input Source is not connected properly, programme registration may not work.
- **Auto Tuning** only finds programmes that are currently broadcasting.
- If **Lock System** is turned on, a pop-up window will appear asking for password.

To use Energy Saving feature

SETTINGS ⇨ PICTURE ⇨  Energy Saving

Reduces power consumption by adjusting screen brightness.

- **Off** : Turns off the Energy Saving mode.
- **Minimum / Medium / Maximum** : Applies the pre-set Energy Saving mode.
- **Screen Off** : Screen is turned off and only sound is played. Press any button except Power button on the remote control to turn the screen back on.

To select Picture Mode

SETTINGS ⇨ PICTURE ⇨ Picture Mode

Select the picture mode optimized for the viewing environment or the programme.

- **Vivid** : Heightens contrast, brightness and sharpness to display vivid images.
- **Standard** : Displays images in standard levels of contrast, brightness and sharpness.
- **Eco** : The Energy Saver feature changes settings on the TV to reduce power consumption.
- **Cinema** : Displays the optimum picture for movie.
- **Sport** : [Depending on model]
Optimizes the video image for high and dynamic actions by emphasizing primary colours such as white, grass, or sky blue.
- **Game** : Displays the optimum picture for game.
- Depending on input signal, available range of picture modes may differ.

Fine-tuning Picture Mode

SETTINGS ⇨ PICTURE ⇨ Picture Mode

This feature allows you to adjust the selected picture mode in detail.

- **Backlight** : Controls the level of screen brightness by adjusting the backlight. The closer to 100, the brighter the screen.
- **Contrast** : Adjusts the contrast of the bright and dark areas of the picture. The closer to 100, the higher the contrast.
- **Brightness** : Adjusts the overall screen brightness. The closer to 100, the brighter the screen.
- **Sharpness** : Adjusts the sharpness of the image. The closer to 50, the sharper and clearer the image.
- **Colour** : Tones down or up the colours displayed on the screen. The closer to 100, the deeper the colour.
- **Tint** : Adjusts the colour balance between red and green displayed on the screen. The closer to Red 50, the more red the colour will be. The closer to Green 50, the more green the colour will be.
- **Colour Temp.** : Adjusts the colour temperature from cold to warm.
- Depending on input signal or other picture settings, the range of detailed items for adjustment may differ.

To set advanced control

SETTINGS ⇨ PICTURE ⇨ Picture Mode ⇨ Advanced Control

Calibrates the screen for each picture mode; or adjusts picture settings for a special screen.

- **Dynamic Contrast** : Adjusts the contrast to the optimal level according to the brightness of the image.
- **Dynamic Colour** : Adjusts colours to make the image appear in more natural colours.
- **Gamma** : Sets the gradation curve according to the output of picture signal in relation to the input signal.
- Depending on input signal or other picture settings, the range of detailed items for adjustment may differ.

To set additional picture options

SETTINGS ⇨ PICTURE ⇨ Picture Mode ⇨ Picture Option

Adjusts detailed setting for images.

- **Noise Reduction** : Eliminates noise in the picture.
- **MPEG Noise Reduction** : Eliminates noise generated while creating digital picture signals.
- **Black Level** : Adjusts the brightness and contrast of the screen to suit the black level of the input picture by using the blackness (black level) of the screen.
- **Real Cinema** : Optimizes the screen for movie viewing.
- Depending on input signal or other picture settings, the range of detailed items for adjustment may differ.

Resetting picture settings

SETTINGS ⇨ PICTURE ⇨ Picture Mode ⇨ Picture Reset

Resets picture settings that the user customizes. Each picture mode is reset. Select the picture mode you wish to reset.

To adjust Aspect Ratio

SETTINGS ⇨ PICTURE ⇨ Aspect Ratio

Selects the screen aspect ratio.

- **16:9** : Displays an aspect ratio of 16:9.
- **Just Scan** : Displays video images in the original size without removing parts of the edge of the image.
 - In DTV, Component, HDMI, and DVI (over 720p) mode, **Just Scan** is available.
- **Original** : Changes the aspect ratio to 4:3 or 16:9 depending on the input video signal.
- **Full Wide** : When TV receives the wide screen signal, it will let you adjust the picture horizontally or vertically, in a linear proportion, to fill the entire screen fully. 4:3 and 14:9 video is supported in full screen without any video distortion through DTV input.
 - In Analogue/DTV/AV/Scart mode, **Full Wide** is available.
- **4:3** : Displays an aspect ratio of 4:3.
- **14:9** : You can view a picture format of 14:9 or a general TV programme in the 14:9 mode. The 14:9 screen is viewed in the same way as in 4:3, but is moved up or down.
- **Zoom** : Resizes images to fit the screen width. The top and bottom parts of the image may be cut off.

Selecting Sound Mode

SETTINGS ⇨ AUDIO ⇨ Sound Mode

Adjusts TV audio to an optimal level based on a selected sound mode.

- **Standard** : Optimizes the sound for all types of content.
- **News** : Boosts voice clarity from the TV.
- **Music** : [Depending on model] Optimizes the sound for music.
- **Cinema** : Optimizes the sound for cinemas.
- **Sport** : [Depending on model] Optimizes the sound for sports.
- **Game** : Optimizes the sound for gameplay.

Using the Sound Effect function

SETTINGS ⇨ AUDIO ⇨ Sound Effect

The user can select various sound effects.

- **Treble** : Controls the dominant sounds in the output.
- **Bass** : Controls the softer sounds in the output.
- **Balance** : Adjusts left/right audio balance.
- **Reset** : Initialize the applied effect under the Sound Effect menu.

To set Auto Volume

SETTINGS ⇨ AUDIO ⇨ Auto Volume

Sets **Auto Volume** to **On**. Varying volume output from programme to programme is automatically adjusted for convenient TV watching when clicking through different programme.

Using Manual Tuning

SETTINGS ⇨ SETUP ⇨ Manual Tuning

Adjusts programmes manually and saves the results.

For digital broadcasting, signal strength and signal quality can be checked.

For analogue broadcasting, you can set up station names and use fine tuning (except for Satellite mode). Normally fine tuning is only necessary if reception is poor.

Editing programmes

SETTINGS ⇨ SETUP ⇨ Programme Edit

Edits the saved programmes.

Set as favourite programme, block/unblock programme, skip programme etc. of the selected programme.

To select Programme mode

SETTINGS ⇨ SETUP ⇨ Programme mode

This function allows you to watch a tuned programme in **Antenna, Cable, Satellite** Mode.

- You can only watch programmes in the selected mode.

About CI Information

SETTINGS ⇨ SETUP ⇨ CI Information

[This feature is available on certain models only.]

- This function enables you to watch some encrypted services (pay services).
- If you remove the CI Module, you cannot watch pay services.
- CI (Common Interface) functions may not be possible depending upon the country broadcasting circumstances.
- When the module is inserted into the CI slot, you can access the module menu.
- To purchase a module and smart card, contact your dealer.
- When the TV is turned on after inserting a CI Module, you may not have any video and audio output in scrambled programme. The Smart Card may not be compatible with the CI module.
- When using a CAM(Conditional Access Module), please make sure it meets fully the requirements of either DVB-CI or CI plus.
- An abnormal process of CAM(Conditional Access Module) may cause a bad picture.
- [This feature is available on certain models only.] If the TV does not display any video and audio when CI+ CAM is connected, please contact to the Terrestrial / Cable / Satellite Service Operator.

To set current time

SETTINGS ⇨ TIME ⇨ Clock

Checks or changes the time while watching TV.

- **Auto** : Synchronizes the TV clock to the digital time information sent by the TV station.
- **Manual** : Sets the time and date manually if the auto setup does not correspond to the current time.

To set the TV to turn on and off automatically

SETTINGS ⇨ TIME ⇨ Off Time / On Time

You can set the Power On/Off time for the TV.

Select **Off** if you are not going to set **Off Time / On Time**.

- To use **Off Time / On Time**, set the current time correctly.
- Even when the **On Time** function is on, the TV will turn off automatically in 120 minutes when no button is pressed within that time.

To use Sleep Timer

SETTINGS ⇨ TIME ⇨ Sleep Timer

Turns off the TV after a preset number of minutes.

To cancel the **Sleep Timer**, select **Off**.

To set Automatic Standby

SETTINGS ⇨ TIME ⇨ Automatic Standby

[This function is available on certain models or in certain countries only]

If you do not press any button on the TV or remote control for a certain period, the TV will automatically switch to standby mode.

- This function does not work on **Store mode** or while **software update**.

To set password

SETTINGS ⇨ LOCK ⇨ Set Password

Sets or changes the TV password.

- The initial password is set to '0000'.
- When France is selected for Country, password is not '0000' but '1234'.
- When France is selected for Country, password cannot be set to '0000'.

To lock system

SETTINGS ⇨ LOCK ⇨ Lock System

Permits only specific programmes by blocking programmes or external input.

First set **Lock System** to **On**.

- **Parental Guidance (Only DTV)** : This function operates according to information from the broadcaster. Therefore if the signal has incorrect information, this function does not operate. Prevents children from watching certain adult TV programmes according to the ratings limit set. Enter a password to watch a blocked programme. Ratings differ by country.
- **Input Block** : Blocks the input sources.

To set Language

SETTINGS ⇨ OPTION ⇨ Language(Language)

You can select the language of the menu displayed on the screen and the digital sound broadcasting.

- **Menu Language** : Selects a language for the display text.
- **Audio Language** : [In Digital mode Only][The configurable items differ depending on country.] Selects the desired language when watching digital broadcasting containing several voice languages.
- **Subtitle Language** : [In Digital mode Only] Use the Subtitle function when two or more subtitle languages are broadcast.
 - If subtitle data in a selected language is not broadcast, the default language subtitle will be displayed.
- **Text Language** : [In Digital mode Only][The configurable items differ depending on country.] Use the Text language function when two or more Text languages are broadcast.
 - If teletext data in a selected language is not broadcast, the default Text language will be displayed.
 - If you select the wrong local country, teletext may not appear correctly on the screen and some problems may occur during teletext operation.

To set the Location

SETTINGS ⇨ OPTION ⇨ Country

[This feature is available in certain countries only.]

Sets the country that the TV uses.

TV settings are changed according to the broadcast environment of the selected country.

- If the country setting is changed, the **Auto Tuning** information screen may appear.
- In a country that Digital broadcasting regulation isn't fixed, some DTV functions may not work depending on digital broadcasting circumstances.
- If the country setting is set to "--", European terrestrial digital standard broadcasting programmes are available, but some DTV functions may not work properly.

To select audio commentary or subtitles

SETTINGS ⇨ OPTION ⇨ Disability Assistance

Audio commentary or subtitles are provided for those who are hard of hearing or visually impaired.

- **Hard of Hearing** : This function is used for the hearing impaired. If it is set to on, the subtitle is displayed by default.
- **Audio Description** : This function is for the blind, and provides explanatory audio describing the current situation in a TV programme in addition to the basic audio. When **Audio Description** is selected **On**, basic audio and Audio Description are provided only for those programmes that have Audio Description included.

To set Subtitle

SETTINGS ⇨ OPTION ⇨ Subtitle

View subtitles when the TV station provides subtitled programming.

Subtitle sets and changes subtitles to **Off**, **On** or **Auto**.

- **Off** : Disable subtitle display.
- **On** : Enable subtitle display.
- **Auto** : Subtitle display automatically.

To specify Factory Reset

SETTINGS ⇨ OPTION ⇨ Factory Reset

All stored information is deleted and TV settings are reset.

TV turns itself off and back on, and all settings are reset.

- When **Lock System** is in place, a pop-up window appears and asks for password.
- Do not turn off the power during initialization.

To change the TV Mode

SETTINGS ⇨ OPTION ⇨ Mode Setting

Selects **Home Mode** or **Store Mode**.

When in use in home, please select **Home Mode**.

Store Mode mode is for store display.



To obtain the source code

SETTINGS ⇒ OPTION ⇒ LGE Open Source Software Notice

To display the open source licenses, that is contained in this product.

To update the software

SETTINGS ⇒ OPTION ⇒ System Info.

Selects **USB Update**, **OAD Update**, or **FW Version**. The firmware will download and install. Upon completion of the update, your LG TV will restart.

- **USB Update** : Updates software via USB device.
- **OAD Update** : Selects **On / Off** to update the operation software using the OAD (Over Air Download) Update.
Automatic update mode means TV will update software automatically, when software was downloaded completed.
- **FW Version** : Checks the software version and Product/Service information.

To use My Media

SETTINGS ⇒ MY MEDIA ⇒ All Media / Movie List / Photo List / Music List

Selects a file from the list. Displays the file that you choose.

Sets play related settings by checking option during disk playback.

To remove the USB device

Q.MENU ⇒ USB Device

Select a USB storage device that you want to remove.

When you see a message that the USB device has been removed, separate the device from the TV.

- Once a USB device has been selected for removal, it can no longer be read. Remove the USB storage device and then re-connect it.

Using a USB storage device - warning

- If the USB storage device has a built-in auto recognition program or uses its own driver, it may not work.
- Some USB storage devices may not work or may work incorrectly.
- Use only USB storage devices formatted with the Windows FAT32 or NTFS File System.
- For external USB HDDs, it is recommended that you use devices with a rated voltage of less than 5 V and a rated current of less than 500 mA.
- It is recommended that you use USB memory sticks of 32 GB or less and USB HDDs of 2 TB or less.
- If a USB HDD with power-saving function does not work properly, turn the power off and on. For more information, refer to the user manual of the USB HDD.
- Data in the USB storage device can be damaged, so be sure to back up important files to other devices. Data maintenance is the user's responsibility and the manufacturer is not responsible for data loss.



My Media supporting file

- Maximum data transfer rate : 20 Mbps (Mega bit per second)
 - External supported subtitle formats : .srt (SubRip), .smi (SAMI), .sub (SubViewer¹, MicroDVD, DVDsubtitleSystem, Subldx(Vobsub)), .ass/.ssa (SubStation Alpha), .txt (TMplayer)
- 1 SubViewer : Supports external subtitles SubViewer1.0 & 2.0 only

Supported Video Formats

- Maximum : 1920 x 1080 @ 30p (Only Motion JPEG 640 x 480 @ 30p)
- .asf, .wmv
[Video] VC-1 (WMV3, WVC1)
[Audio] WMA7,8,9 Standard
- .avi, .xvid
[Video] MPEG2, MPEG4 Part2, XVID, H.264/AVC
[Audio] HE-AAC, LPCM, ADPCM, Dolby Digital (AC3), MP3
- .ts, .trp, .tp
[Video] H.264/AVC, MPEG2, HEVC
[Audio] MP3, Dolby Digital (AC3), AAC, HE-AAC
- .vob
[Video] MPEG1, MPEG2
[Audio] Dolby Digital (AC3), DVD LPCM
- .mp4, .mov
[Video] MPEG4 Part2, XVID, H.264/AVC, HEVC
[Audio] AAC, MP3
- .mkv
[Video] MPEG2, MPEG4 Part2, H.264/AVC, HEVC
[Audio] HE-AAC, Dolby Digital(AC3), MP3, LPCM
- .mpg, .mpeg
[Video] MPEG1, MPEG2
[Audio] Dolby Digital (AC3), LPCM
- .dat
[Video] MPEG1
[Audio] MP2
- .flv
[Video] Sorenson H.263, H.264/AVC
[Audio] MP3, AAC

Supported Audio Formats

- File type : .mp3
[Bit rate] 32 Kbps - 320 Kbps
[Sample freq.] 8 kHz - 48 kHz
[Support] MPEG1 Layer2, MPEG1 Layer3, MPEG2, MPEG2.5
- File type : .wma
[Bit rate] 4 Kbps - 320 Kbps
[Sample freq.] 8 kHz - 48 kHz
[Support] WMA

Supported Photo Formats

- Category : 2D (jpeg)
[Available file type]
SOF0 : Baseline,
SOF1 : Extend Sequential,
SOF2 : Progressive
[Photo size]
Minimum : 64 x 64,
Maximum (Normal Type) : 15360 (W) x 8640 (H),
Maximum (Progressive Type) : 1024 (W) x 768 (H)

Troubleshooting

Cannot control the TV with the remote control.

- Check the remote control sensor on the product and try again.
- Check if there is any obstacle between the product and the remote control.
- Check if the batteries are still working and properly installed (⊕ to ⊕, ⊖ to ⊖).

No image display and no sound is produced.

- Check if the product is turned on.
- Check if the power cord is connected to a wall outlet.
- Check if there is a problem in the wall outlet by connecting other products.

The TV turns off suddenly.

- Check the power control settings. The power supply may be interrupted.
- Check if the **Auto Power Off** (Depending on model) / **Sleep Timer / Off Time** is activated in the **TIME** settings.
- If there is no signal while the TV is on, the TV will turn off automatically after 15 minutes of inactivity.

When connecting to the PC (HDMI), 'No signal' or 'Invalid Format' is displayed.

- Turn the TV off/on using the remote control.
- Reconnect the HDMI cable.
- Restart the PC with the TV on.

Abnormal Display

- If the product feels cold to the touch, there may be a small "flicker" when it is turned on. This is normal, there is nothing wrong with product.
- This panel is an advanced product that contains millions of pixels. You may see tiny black dots and/or brightly coloured dots (red, blue or green) at a size of 1 ppm on the panel. This does not indicate a malfunction and does not affect the performance and reliability of the product.

This phenomenon also occurs in third-party products and is not subject to exchange or refund.

- You may find different brightness and color of the panel depending on your viewing position(left/right/top/down). This phenomenon occurs due to the characteristic of the panel. It is not related with the product performance, and it is not malfunction.
- Displaying a still image for a prolonged period of time may cause image sticking. Avoid displaying a fixed image on the TV screen for a long period of time.

Generated Sound

- "Cracking" noise: A cracking noise that occurs when watching or turning off the TV is generated by plastic thermal contraction due to temperature and humidity. This noise is common for products where thermal deformation is required.
- Electrical circuit humming/panel buzzing: A low level noise is generated from a high-speed switching circuit, which supplies a large amount of current to operate a product. It varies depending on the product.
This generated sound does not affect the performance and reliability of the product.

Specifications

ENGLISH

CI Module Size (W x H x D)		100.0 mm x 55.0 mm x 5.0 mm
Environment condition	Operating Temperature	0 °C to 40 °C
	Operating Humidity	Less than 80 %
	Storage Temperature	-20 °C to 60 °C
	Storage Humidity	Less than 85 %

(Depending on country)

	Digital TV			Analogue TV
Television system	DVB-T DVB-T2 DVB-C DVB-S/S2			PAL B/G/D/K/I SECAM L
Channel coverage (Band)	DVB-S/S2	DVB-C	DVB-T/T2	46 ~ 862 Mhz
	950 ~ 2150 Mhz	46 ~ 890 Mhz	VHF III : 174 ~ 230 Mhz UHF IV : 470 ~ 606 Mhz UHF V : 606 ~ 862 Mhz	
Maximum number of storable programmes	4,000	1,100		
External antenna impedance	75 Ω			

HDMI-DTV supported mode

Resolution	Horizontal Frequency (kHz)	Vertical Frequency (Hz)
640 x 480p	31.47	59.94
	31.50	60.00
720 (1440) x 480i	15.73	59.94
	15.75	60.00
720 x 480p	31.47	59.94
	31.50	60.00
720 (1440) x 576i	15.63	50.00
720 x 576p	31.25	50.00
1280 x 720p	44.96	59.94
	45.00	60.00
	37.50	50.00
1920 x 1080i	33.72	59.94
	33.75	60.00
	28.13	50.00
1920 x 1080p	67.43	59.94
	67.50	60.00
	56.25	50.00
	26.97	23.976
	27.00	24.00
	33.72	29.97
	33.75	30.00

HDMI-PC supported mode

Resolution	Horizontal Frequency (kHz)	Vertical Frequency (Hz)
720 x 400	31.469	70.08
640 x 480	31.469	59.94
800 x 600	37.879	60.31
1024 x 768	48.363	60.00
1280 x 720	45.00	60.00
1360 x 768	47.712	60.015
1366 x 768	47.712	59.79
1280 x 1024 (FHD only)	63.981	60.020
1920 x 1080 (FHD only)	67.50	60.00

1: Only 28MT42**, 32LJ500U

2: Only 32LJ500V, 43LJ50**

Component port connecting information

Component ports on the TV	Y	P _B	P _R
Video output ports on DVD player	Y	P _B	P _R
	Y	B-Y	R-Y
	Y	Cb	Cr
	Y	Pb	Pr

Signal	Component
480i / 576i	0
480p / 576p	0
720p / 1080i	0
1080p	0 (Only 50 Hz / 60 Hz)

Resolution	Horizontal Frequency (kHz)	Vertical Frequency (Hz)
720 (1440) x 480i	15.73	59.94
	15.75	60.00
720 x 480p	31.47	59.94
	31.50	60.00
720 (1440) x 576i	15.63	50.00
720 x 576p	31.25	50.00
1280 x 720p	44.96	59.94
	45.00	60.00
	37.50	50.00
1920 x 1080i	33.72	59.94
	33.75	60.00
	28.13	50.00
1920 x 1080p	67.43	59.94
	67.50	60.00
	56.25	50.00