

49XE4F
55XE4F

ENGLISH Installation Guide

Please read this manual carefully before operating your set and retain it for future reference.

FRANÇAIS Guide d'installation

Veuillez lire ce manuel attentivement avant d'utiliser l'appareil et conservez-le pour pouvoir vous y reporter ultérieurement.

ESPAÑOL Guía de instalación

Lea atentamente este manual antes de poner en marcha el equipo y consérvelo para futuras consultas.

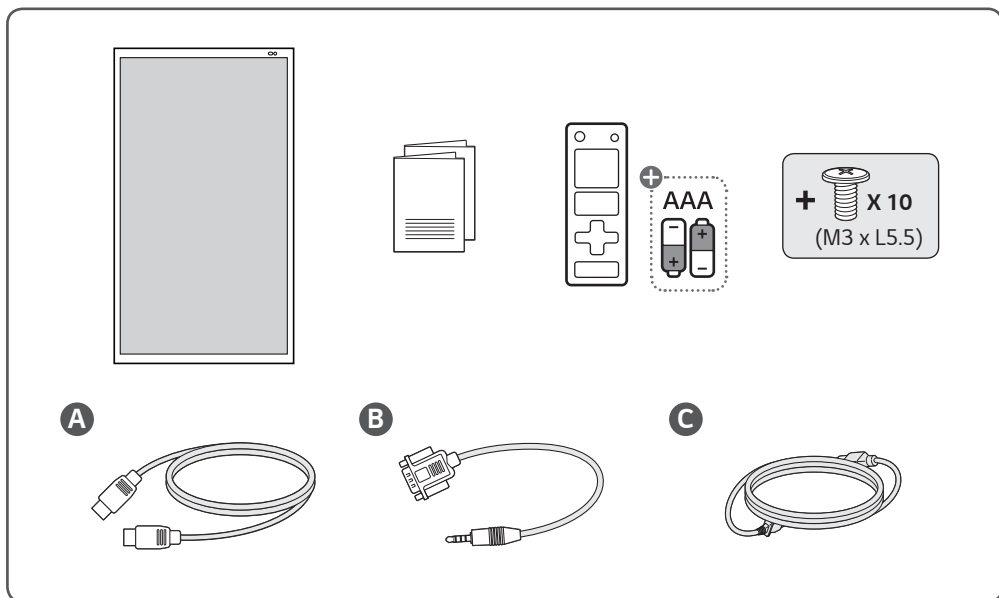



- ▶ www.lg.com/id-manual
- ▶ SuperSign : <http://partner.lge.com>

ENGLISH You can download more detailed information on our website by searching the model number provided on the cover page.

FRANÇAIS Vous pouvez télécharger des informations plus détaillées sur notre site Web en faisant une recherche à l'aide du numéro de modèle indiqué sur la page de couverture.

ESPAÑOL Busque en nuestro sitio web el número de modelo que aparece en la portada y descargue información más detallada.



ENGLISH

- A readily accessible disconnect device shall be incorporated external to the product.
- The components complied with the requirements of IEC 61643-series shall be installed internal or external to this product.

FRANÇAIS

- Un périphérique de déconnexion facilement accessible doit être incorporé au produit en externe.
- Les composants conformes aux exigences de la série IEC 61643 doivent être installés avec ce produit, en interne ou en externe.

ESPAÑOL

- Los dispositivos de desconexión disponibles deberán incorporarse al producto de forma externa.
- Los componentes que cumplan con los requisitos de la serie IEC 61643 deberán instalarse en este producto de forma interna o externa.



ENGLISH

Dimensions (Width x Height x Depth) / Weight	49XE4F	1,153 mm x 656.2 mm x 88 mm / 32 kg
	55XE4F	1,292.5 mm x 737.4 mm x 88 mm / 40 kg

FRANÇAIS

Dimensions (largeur x hauteur x profondeur) / poids	49XE4F	1 153 mm x 656,2 mm x 88 mm / 32 kg
	55XE4F	1 292,5 mm x 737,4 mm x 88 mm / 40 kg

ESPAÑOL

Dimensiones (ancho x alto x profundidad) / Peso	49XE4F	1 153 mm x 656,2 mm x 88 mm / 32 kg
	55XE4F	1 292,5 mm x 737,4 mm x 88 mm / 40 kg
Alimentación	49XE4F	CA 100-240 V ~ 50/60 Hz 3,8 A
	55XE4F	CA 100-240 V ~ 50/60 Hz 4,1 A



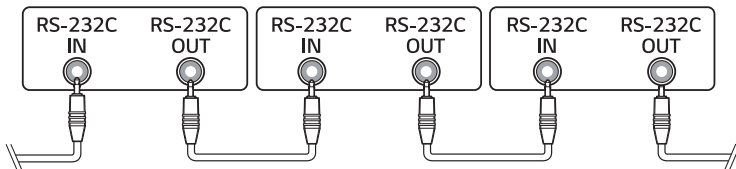
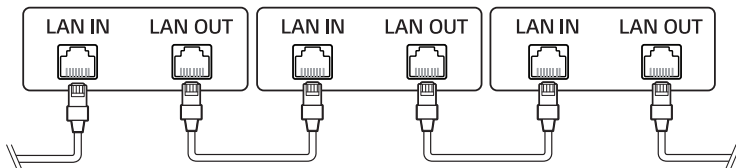
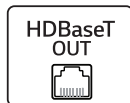
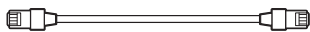
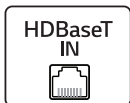
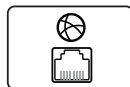
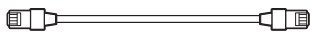
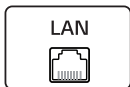
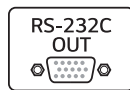
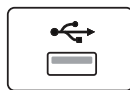
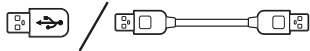
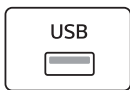



49XE4F

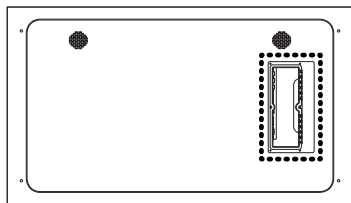

55XE4F

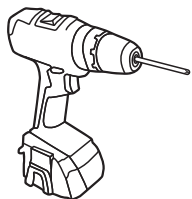
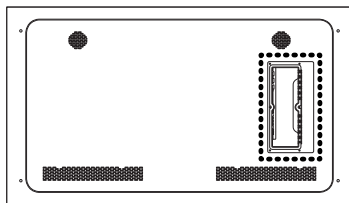

1

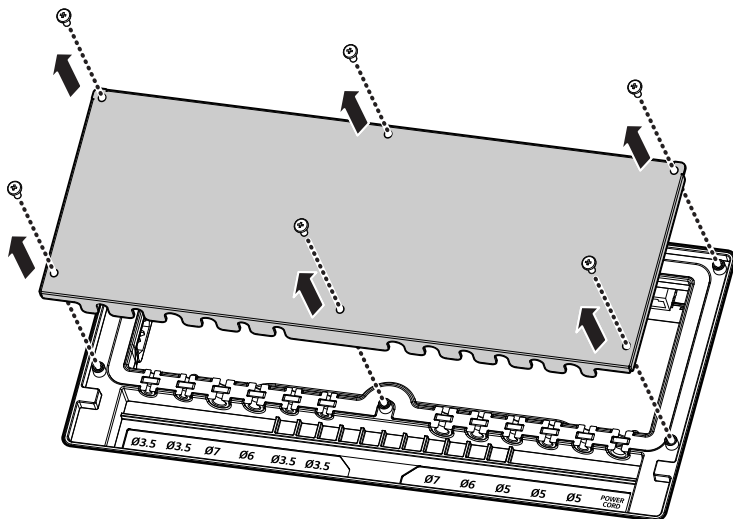



2

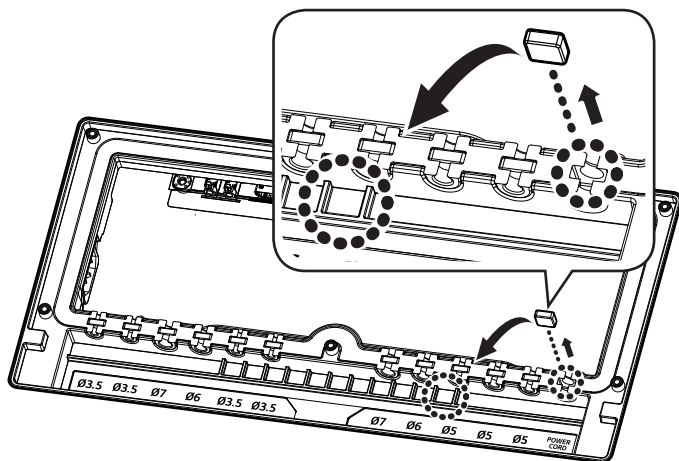

3

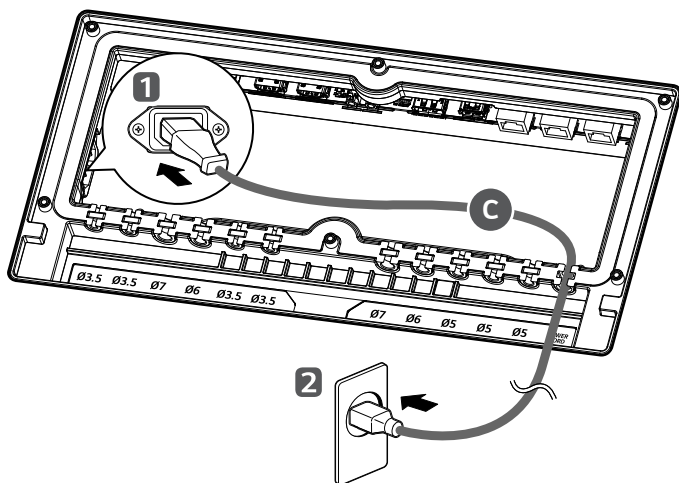



4

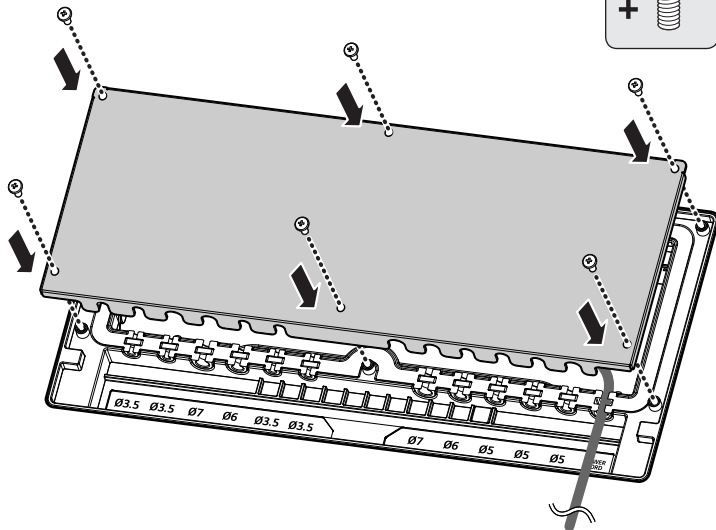



1

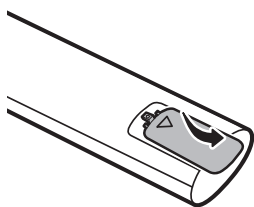

2

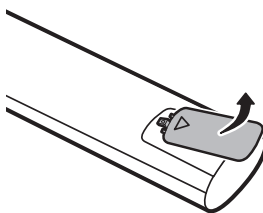

3

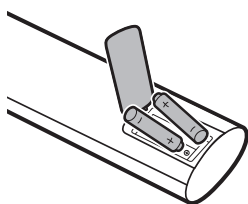

4

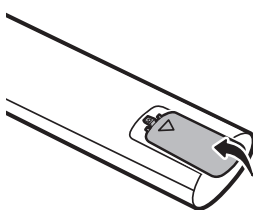

ENGLISH

Due to the environment regulations about importation and disposal of batteries, remote control batteries will not be provided with LG monitor signage / commercial TV models (Argentina and Colombia).

ESPAÑOL

Por regulaciones de tipo ambiental respecto a la importación y destrucción de baterías, LG monitor signage / commercial TVs no van a traer incluidas las pilas del control remoto (Argentina y Colombia).

