

OLED42C3PSA

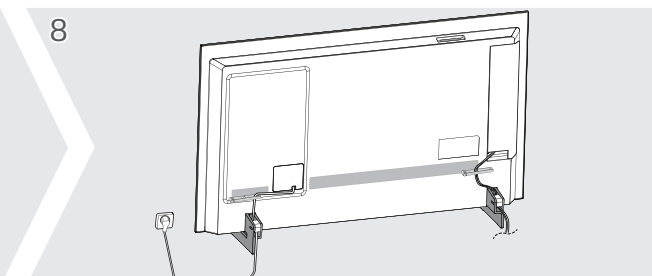

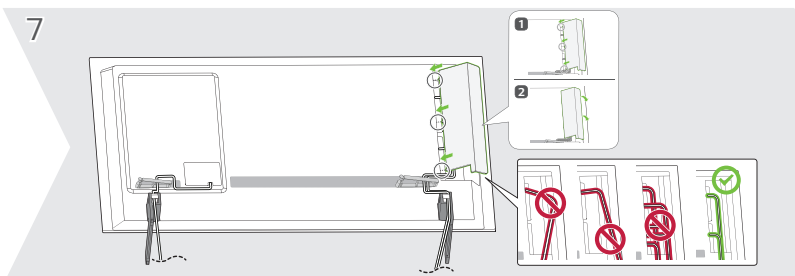

MODELO	A	B	C	D	E	F	F - G	Consumo de potência
OLED42C3PSA	932 mm (36.6) pol.	577 mm (22.7) pol.	170 mm (6.6) pol.	540 mm (21.2) pol.	41.1mm (1.6) pol.	10.1 kg (22.2) lbs	9.8 kg (21.6) lbs	156 W

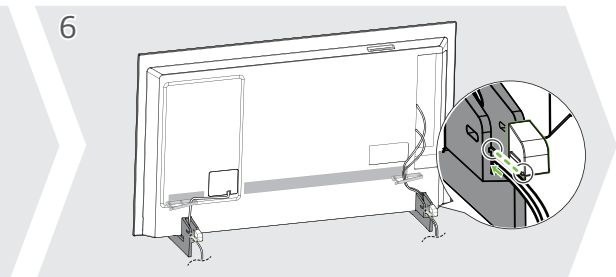
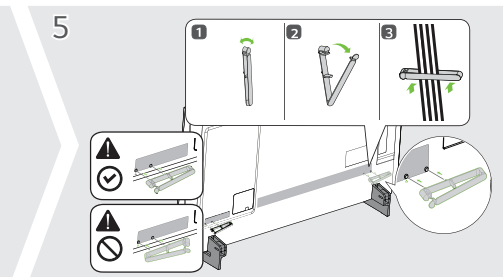
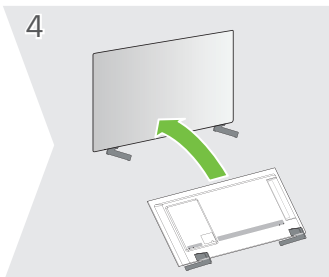
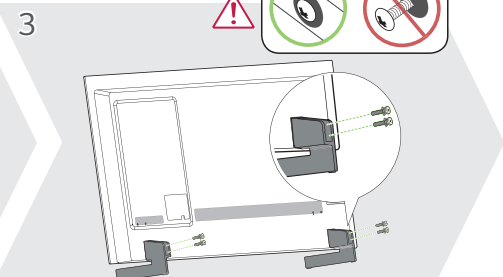
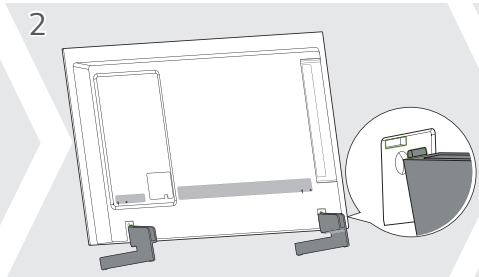
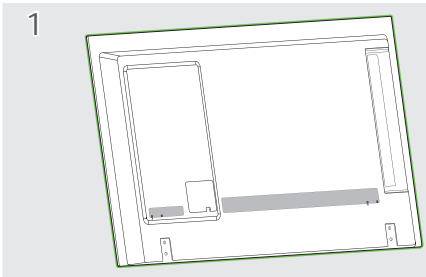
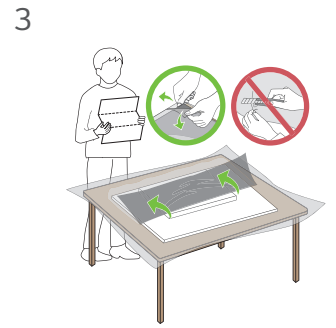
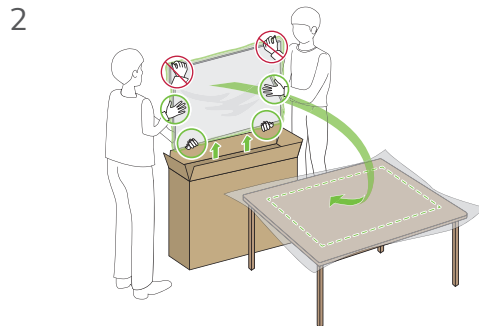
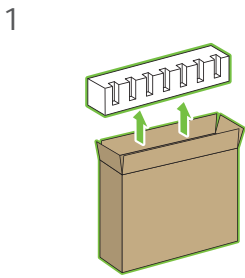
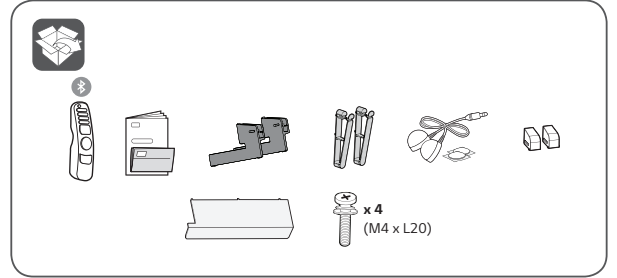
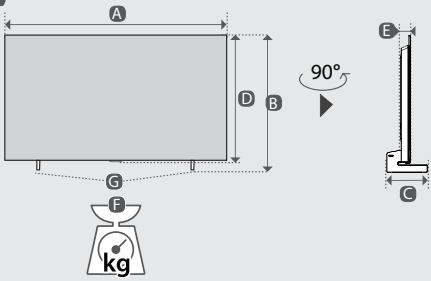
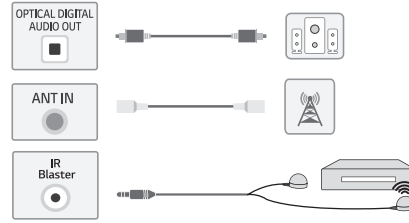
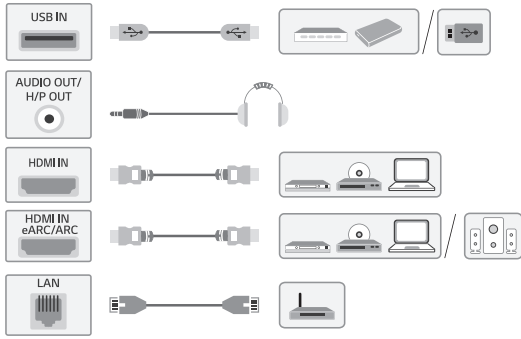
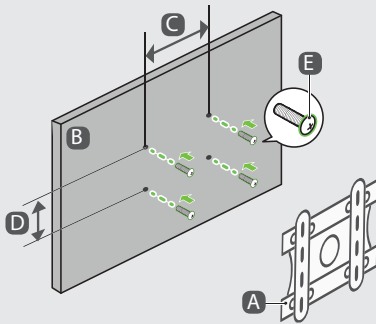

A	B	C x D	E
OLW480B	OLED42C3*	300 x 200 mm (11.8 x 7.8) pol.	M6

A/ E Não incluso no produto

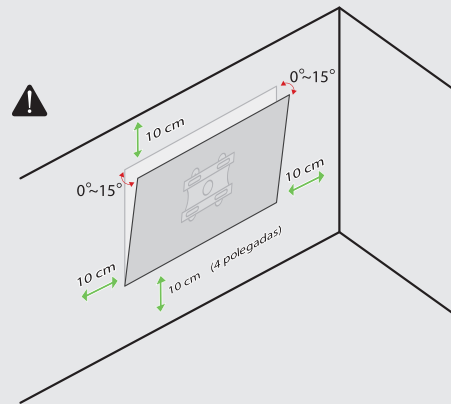

**PRODUZIDO NO
POLO INDUSTRIAL
DE MANAUS**



LG Electronics do Brasil Ltda.
CNPJ: 01.166.372/0008-21
Rua Javari, nº 1004, Distrito Industrial, CEP
69075-110, Manaus/AM, Indústria Brasileira