

English

- Read **Safety and Reference**.
- For the power supply and power consumption, refer to the label attached to the product.

Русский

- Прочтите **Руководство по технике безопасности**.
- Требования параметров электропитания указаны на информационном лейбле на задней крышке изделия.

Українська

- Прочитайте **"Правила безпеки та довідкова інформація"**.
- Відомості щодо подачі живлення і споживання електроенергії дивіться на наліпці на виробі.

Қазақша

- **Қауіпсіздік нұсқаулығын** оқыңыз.
- Электр энергия және тұтыну параметр мәліметтерін өнімдегі жапсырмадан қараңыз.

O'zbekcha

- **Xavfsizlik bo'yicha ko'rsatmalar va havolalar** o'qib chiqing.
- Quvvat ta'minoti va quvvat iste'moli uchun mahsulotga yopishtirilgan yorliqqa qarang.

Монгол

- **Аюулгүй ажиллагааны зааварчилгаа** унш.
- Тэжээл, цахилгаан зарцуулалтын талаарх мэдээллийг бүтээгдэхүүний шошгоос харна уу.

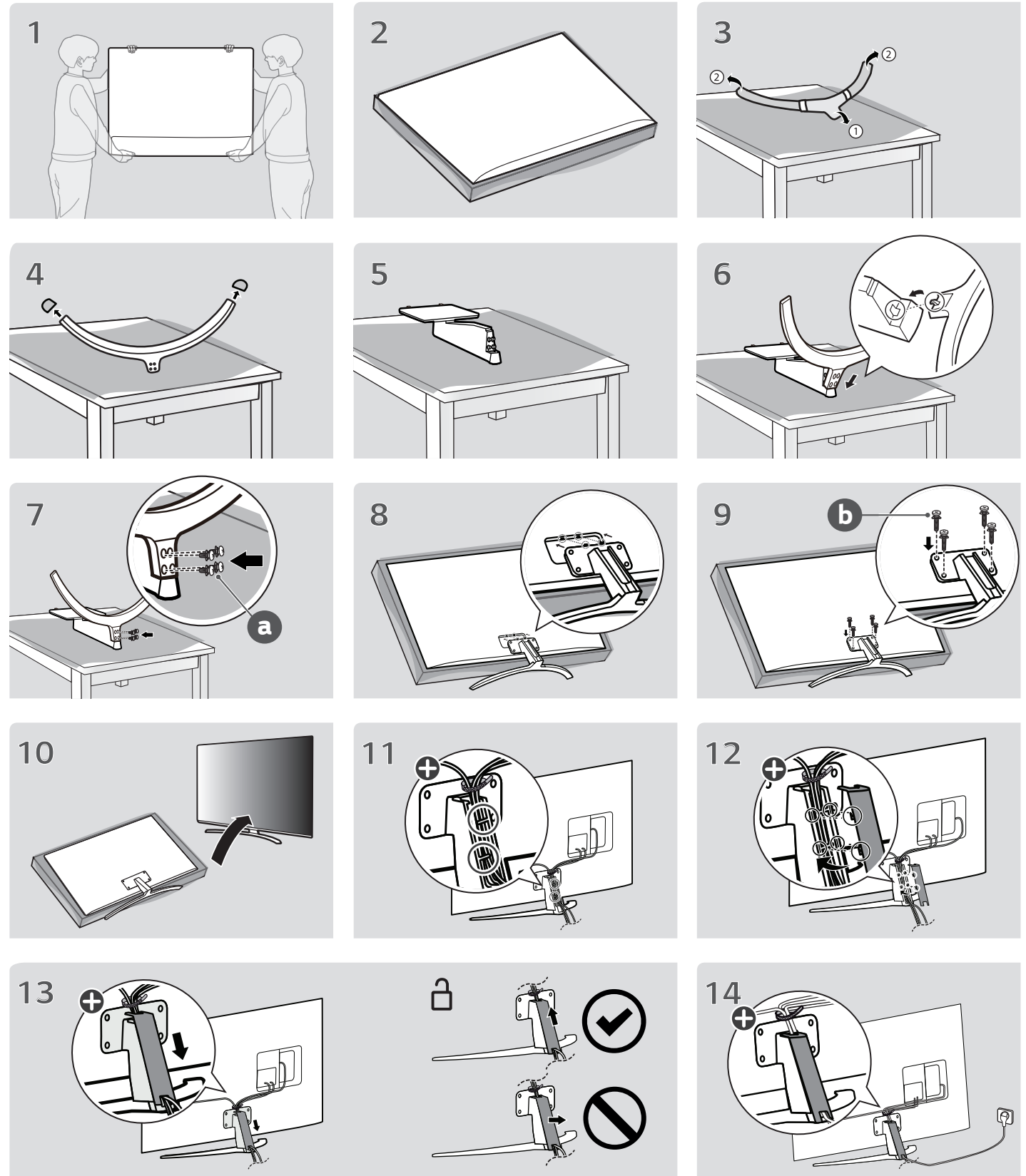

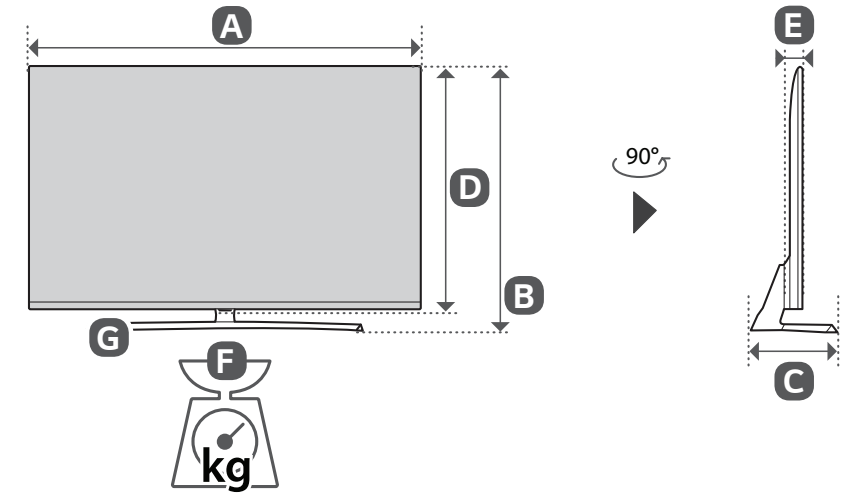
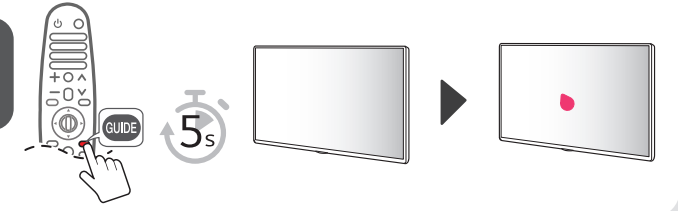
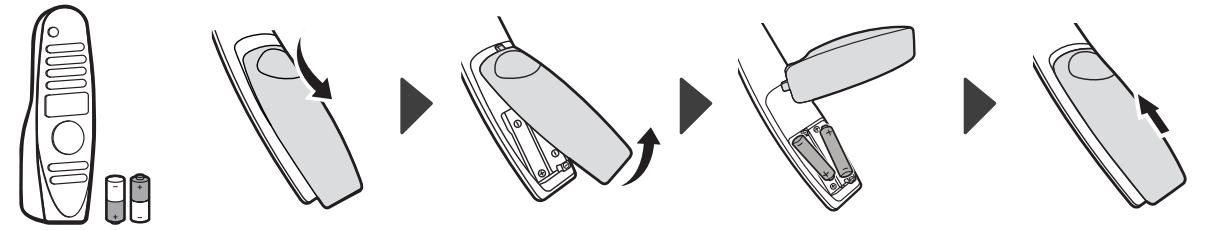
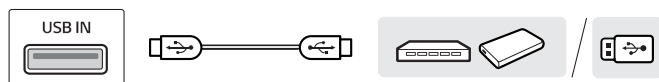
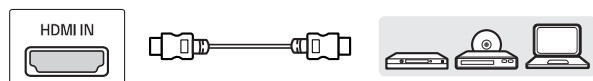
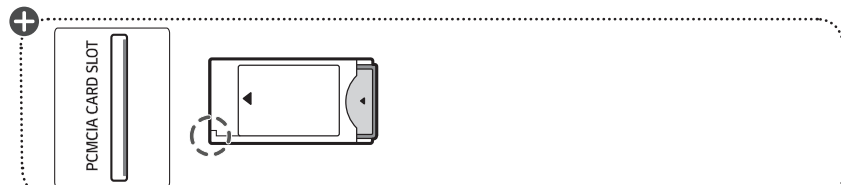
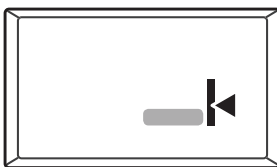
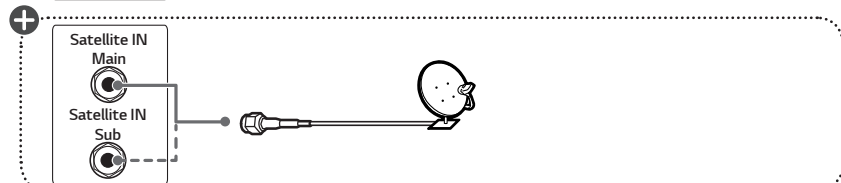
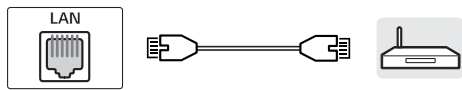
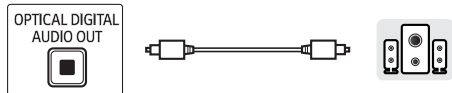
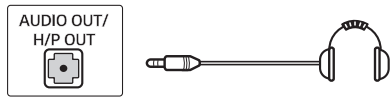
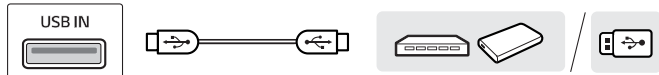
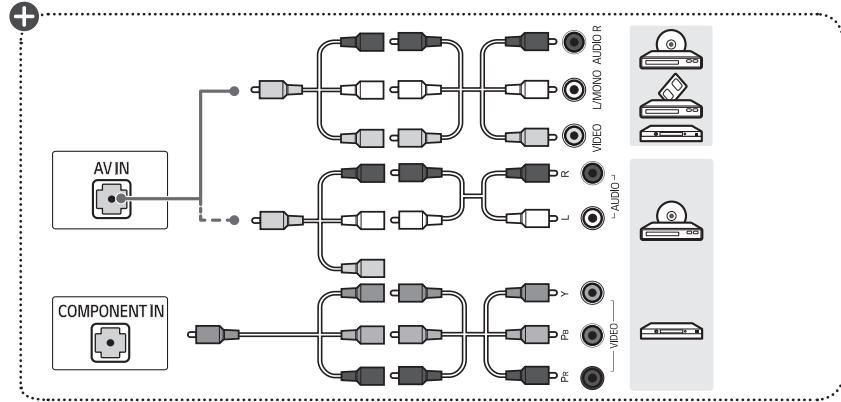
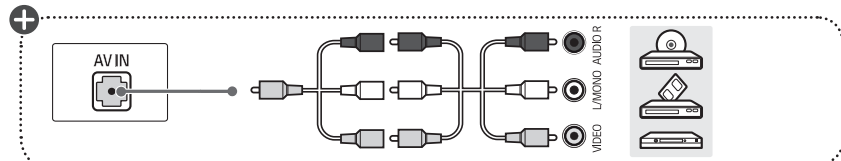
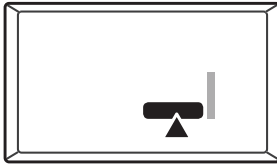

	A	B	C	D	E	F	F-G
	(mm)					(kg)	
75SM9000PLA	1677	1037	384	966	69.9	40.8	37.9
86SM9000PLA	1926	1183	432	1106	73.6	57.6	54.1
Power requirement				AC 100-240 V - 50/60 Hz			