

# INSTALLATION MANUAL

# AIR CONDITIONER

Please read this installation manual completely before installing the product. Installation work must be performed in accordance with the national wiring standards by authorized personnel only. Please retain this installation manual for future reference after reading it thoroughly.

Ceiling Cassette - 4Way



P/NO : MFL42803130  
Rev.08\_062218

<http://www.lghvac.com>  
[www.lg.com](http://www.lg.com)

Copyright © 2013 - 2018 LG Electronics Inc. All Rights Reserved.

## IMPORTANT!

Please read this instruction sheet completely before installing the product.

This air conditioning system meets strict safety and operating standards. As the installer or service person, it is an important part of your job to install or service the system so it operates safely and efficiently.



### WARNING

- The information contained in the manual is intended for use by a qualified service technician familiar with safety procedures and equipped with the proper tools and test instruments.
- Failure to carefully read and follow all instructions in this manual can result in equipment malfunction, property damage, personal injury and/or death.

**Caution:** Improper installation, adjustment, alteration, service or maintenance can void the warranty. The weight of the condensing unit requires caution and proper handling procedures when lifting or moving to avoid personal injury. Use care to avoid contact with sharp or pointed edges.

### Safety Precautions

- Always wear safety eye wear and work gloves when installing equipment.
- Never assume electrical power is disconnected. Check with meter and equipment.
- Keep hands out of fan areas when power is connected to equipment.
- R-410A causes frostbite burns.
- R-410A is toxic when burned.

**Note to installing dealer:** The Owners Instructions and Warranty are to be given to the owner or prominently displayed near the indoor Furnace/Air Handler Unit.



### WARNING

#### When wiring:

**Electrical shock can cause severe personal injury or death. Only a qualified, experienced electrician should attempt to wire this system.**

- Do not supply power to the unit until all wiring and tubing are completed or reconnected and checked.
- Highly dangerous electrical voltages are used in this system. Carefully refer to the wiring diagram and these instructions when wiring. Improper connections and inadequate grounding can cause accidental injury or death.
- Ground the unit following local electrical codes.
- Connect all wiring tightly. Loose wiring may cause overheating at connection points and a possible fire hazard.

#### When transporting:

Be careful when picking up and moving the indoor and outdoor units. Get a partner to help, and bend your knees when lifting to reduce strain on your back. Sharp edges or thin aluminum fins on the air conditioner can cut your finger.

#### When installing...

- ... **in a wall:** Make sure the wall is strong enough to hold the unit's weight. It may be necessary to construct a strong wood or metal frame to provide added support.
- ... **in a room:** Properly insulate any tubing run inside a room to prevent "sweating" that can cause dripping and water damage to wall and floors.
- ... **in moist or uneven locations:** Use a raised concrete pad or concrete blocks provide a solid, level foundation for the outdoor unit. This prevents water damage and abnormal vibration.
- ... **in an area with high winds:** Securely anchor the outdoor unit down with bolts and a metal frame. Provide a suitable air baffle.
- ... **in a snowy area (for Heat Pump Model):** Install the outdoor unit on a raised platform that is higher than drifting snow. Provide snow vents.

#### When connecting refrigerant tubing:

- Keep all tubing runs as short as possible.
- Use the flare method for connecting tubing.
- Check carefully for leaks before starting the test run.

#### When servicing:

- Turn the power OFF at the main power box (mains) before opening the unit to check or repair electrical parts and wiring.
- Keep your fingers and clothing away from any moving parts.
- Clean up the site after you finish, remembering to check that no metal scraps or bits of wiring have been left inside the unit being serviced.

---

# TABLE OF CONTENTS

---

## 4 INSTALLATION PARTS

---

## 5 SAFETY PRECAUTIONS

---

## 7 INSTALLATION





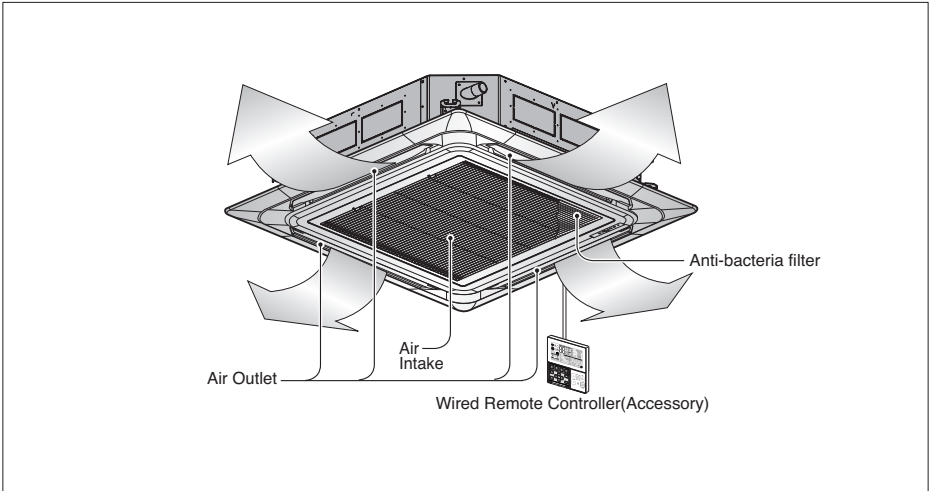

---

- 7 Selection of the best location
- 8 Ceiling dimension and hanging bolt location
- 9 Wiring Connection
- 12 Plumbing materials and storage methods
- 13 Flaring Work
- 14 Installation of Decoration Panel
- 15 Drain Piping
- 16 Ceiling Height Selection
- 17 DIP Switch Setting
- 18 Group Control Setting
- 22 Model Designation
- 22 Airborne Noise Emission
- 22 Limiting concentration

# Installation Parts



## Installation Tool

Name	Drain hose	Clamp metal	Washer for hanging bracket	Plastic band	Insulation for fitting	Conduit mounting plate	(Other)
Quantity	1 EA	2 EA	8 EA	4 EA	1 SET	1 EA	<ul style="list-style-type: none"> <li>• Paper pattern for installation</li> <li>• Owner's manual</li> <li>• Installation manual</li> </ul>
Shape					 for gas pipe  for liquid pipe		

• Screws for fixing panels are attached to decoration panel.

# Safety Precautions



To prevent injury to the user or other people and property damage, the following instructions must be followed.

- Be sure to read before installing the air conditioner.
- Be sure to observe the cautions specified here as they include important items related to safety.
- Incorrect operation due to ignoring instruction will cause harm or damage. The seriousness is classified by the following indications.

**▲ WARNING** This symbol indicates the possibility of death or serious injury.

**▲ CAUTION** This symbol indicates the possibility of injury or damage to properties only.

- Meanings of symbols used in this manual are as shown below.

	<b>Be sure not to do.</b>
	<b>Be sure to follow the instruction.</b>

## ▲ WARNING

### Installation

- Do not use a defective or underrated circuit breaker. Use this appliance on a dedicated circuit.
  - There is risk of fire or electric shock.
- For electrical work, contact the dealer, seller, a qualified electrician, or an Authorized Service Center.
  - Do not disassemble or repair the product. There is risk of fire or electric shock.
- Always ground the product.
  - There is risk of fire or electric shock.
- Install the panel and the cover of control box securely.
  - There is risk of fire or electric shock.
- Always install a dedicated circuit and breaker.
  - Improper wiring or installation may cause fire or electric shock.
- Use the correctly rated breaker or fuse.
  - There is risk of fire or electric shock.
- Do not modify or extend the power cable.
  - There is risk of fire or electric shock.
- Do not let the air conditioner run for a long time when the humidity is very high and a door or a window is left open.
  - Moisture may condense and wet or damage furniture.
- Be cautious when unpacking and installing the product.
  - Sharp edges could cause injury. Be especially careful of the case edges and the fins on the condenser and evaporator.

## Safety Precautions

---

- For installation, always contact the dealer or an Authorized Service Center.
  - There is risk of fire, electric shock, explosion, or injury.
- Do not install the product on a defective installation stand.
  - It may cause injury, accident, or damage to the product.
- Be sure the installation area does not deteriorate with age.
  - If the base collapses, the air conditioner could fall with it, causing property damage, product failure, and personal injury.
- Use a vacuum pump or Inert (nitrogen) gas when doing leakage test or air purge. Do not compress air or Oxygen and Do not use Flammable gases.  
Otherwise, it may cause fire or explosion.
  - There is the risk of death, injury, fire or explosion.
- Do not turn on the breaker or power under condition that front panel, cabinet, top cover, control box cover are removed or opened.
  - Otherwise, it may cause fire, electric shock, explosion or death.

## Operation

- Do not store or use flammable gas or combustibles near the product.
  - There is risk of fire or failure of product.

---

 **CAUTION**

---

## Installation

- Always check for gas (refrigerant) leakage after installation or repair of product.
  - Low refrigerant levels may cause failure of product.
- Install the drain hose to ensure that water is drained away properly.
  - A bad connection may cause water leakage.
- Keep level even when installing the product.
  - To avoid vibration or water leakage.
- Use two or more people to lift and transport the product.
  - Avoid personal injury.
- Do not install the product where it will be exposed to sea wind (salt spray) directly.
  - It may cause corrosion on the product. Corrosion, particularly on the condenser and evaporator fins, could cause product malfunction or inefficient operation.

# Installation

Read completely, then follow step by step.

## Selection of the best location

- There should not be any heat source or steam near the unit.
- There should not be any obstacles to the air circulation.
- A place where air circulation in the room will be good.
- A place where drainage can be easily obtained.
- A place where noise prevention is taken into consideration.
- Do not install the unit near the door way.
- Ensure the spaces indicated by arrows from the wall, ceiling, or other obstacles.
- The indoor unit must have the maintenance space.

\* Case of the size  
[Width : 570(22-7/16)] x [Depth : 570(22-7/16)]

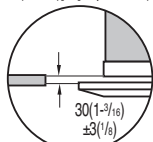

\* Case of the size  
[Width : 840(33-1/16)] x [Depth : 840(33-1/16)]

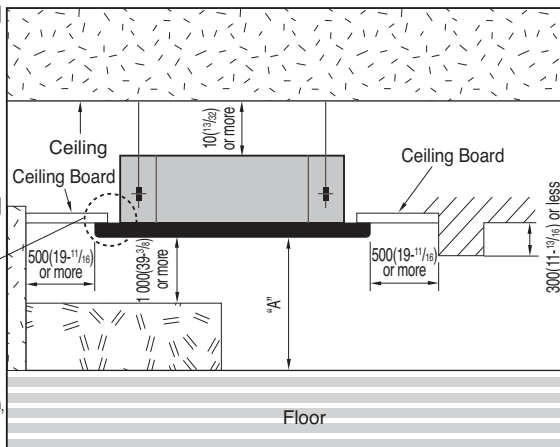
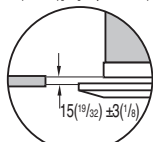

Unit:mm(inch)

"A"  
Below 36 kBtu/h(10.6 kW) At least 1 800(70-7/8),  
3 600(141-27/32) or less  
Over 36 kBtu/h(10.6 kW) At least 1 800(70-7/8),  
4 200(165-11/32) or less

**CAUTION :** In case that the unit is installed near the sea, the installation parts may be corroded by salt. The installation parts (and the unit) should be taken appropriate anti-corrosion measures.

**CAUTION :** Don't install additional ventilation products on the cabinet of cassette type air conditioner.

\* Please use an annexed sheet or the corrugated cardboard on the bottom of packing as installation sheet.

\* When using the bottom sheet, please use it after separating the installation sheet from packing of the product floor by using a knife etc as a picture below.



Annexed sheet

Or



Packing corrugated cardboard on the bottom

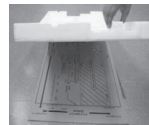

## Ceiling dimension and hanging bolt location

- The dimensions of the paper model for installation are the same as those of the ceiling opening dimensions.

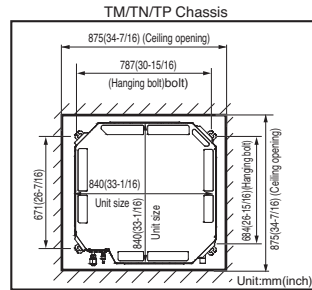
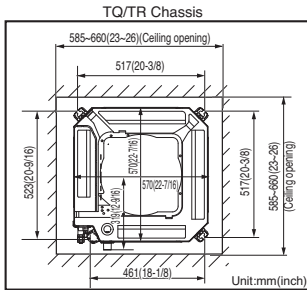
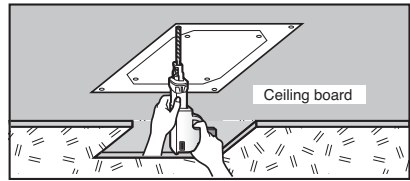
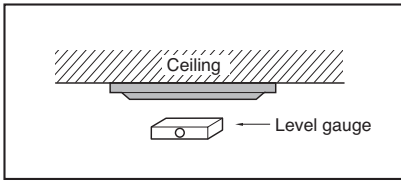

### CAUTION :

- This air-conditioner uses a drain pump.
- Install the unit horizontally using a level gauge.
- During the installation, care should be taken not to damage electric wires.
- Select and mark the position for fixing bolts and piping hole.
- Decide the position for fixing bolts slightly tilted to the drain direction after considering the direction of drain hose.
- Drill the hole for anchor bolt on the wall.

### NOTICE

- Avoid the following installation location.
  - Such places as restaurants and kitchen where considerable amount of oil steam and flour is generated. These may cause heat exchange efficiency reduction, or water drops, drain pump mal-function. In these cases, take the following actions;
    - Make sure that ventilation fan is enough to cover all noxious gases from this place.
    - Ensure enough distance from the cooking room to install the air conditioner in such a place where it may not suck oily steam.
  - Avoid installing air conditioner in such places where cooking oil or iron powder is generated.
  - Avoid places where inflammable gas is generated.
  - Avoid place where noxious gas is generated.
  - Avoid places near high frequency generators.

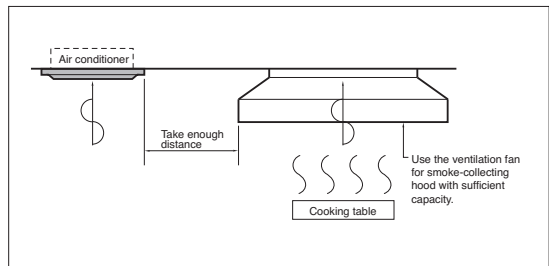

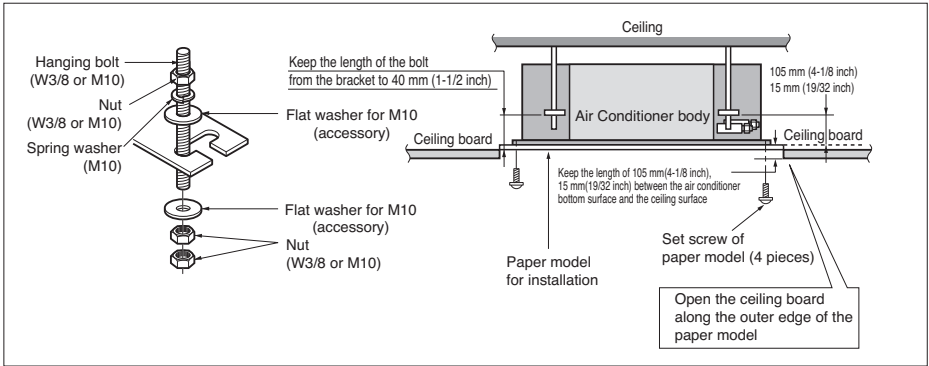

- The following parts are local purchasing.
- ① Hanging Bolt - W 3/8 or M10
- ② Nut - W 3/8 or M10
- ③ Spring Washer - M10
- ④ Plate Washer - M10

**CAUTION : Tighten the nut and bolt to prevent unit from falling off.**

### Wiring Connection

- Open the control box cover and connect the remote control cord and Indoor power wires.

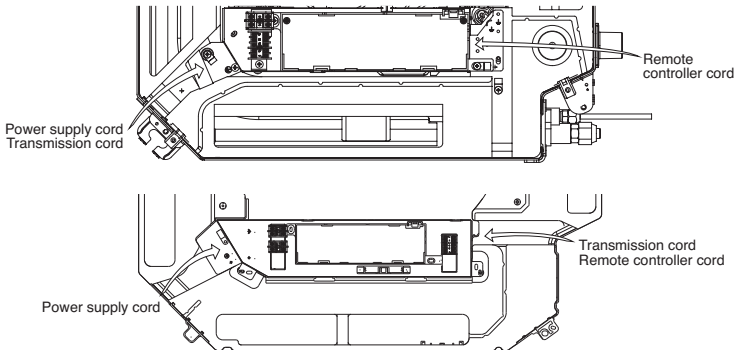

#### • TQ/TR Chassis

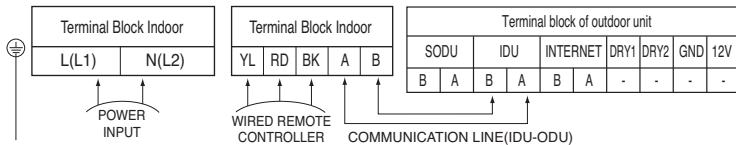

#### • TM/TN/TP Chassis

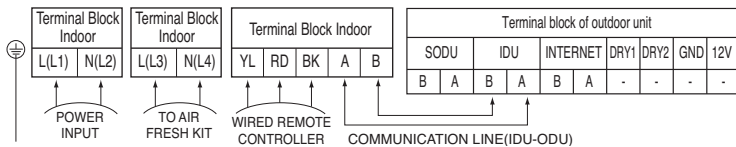

**WARNING : Make sure that the screws of the terminal are free from looseness.**

## Connection method of the connecting cable(Example)

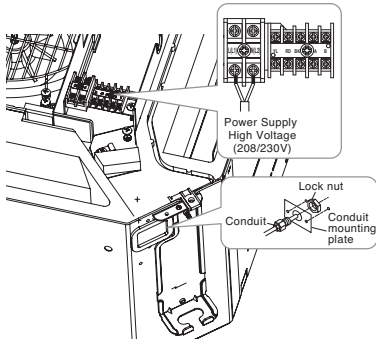

• TQ/TR Chassis

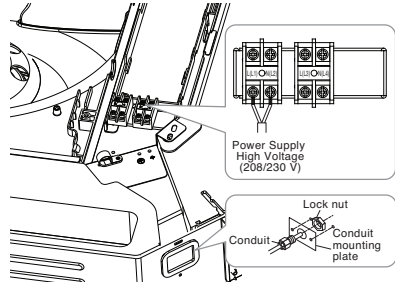

• TM/TN/TP Chassis



**WARNING :** Loose wiring may cause the terminal to overheat or result in unit malfunction.

A fire hazzard may also exist.

Therefore, be sure all wiring is tightly connected.



### CAUTION:

After the confirmation of the above conditions, prepare the wiring as follows:

- 1) Never fail to have an individual power specialized for the air conditioner. As for the method of wiring, be guided by the circuit diagram posted on the inside of control box cover.
- 2) Provide a circuit breaker switch between power source and the unit.
- 3) The screws which fasten the wiring in the casing of electrical fittings are liable to come loose from vibrations to which the unit is subjected during the course of transportation. Check them and make sure that they are all tightly fastened. (If they are loose, it could give rise to burn-out of the wires.)
- 4) Specification of power source
- 5) Confirm that electrical capacity is sufficient.
- 6) Be sure that the starting voltage is maintained at more than 90 percent of the rated voltage marked on the name plate.
- 7) Confirm that the cable thickness is as specified in the power sources specification. (Particularly note the relation between cable length and thickness.)
- 8) Never fail to equip a leakage breaker where it is wet or moist.
- 9) The following troubles would be caused by voltage drop-down.
  - Vibration of a magnetic switch, damage on the contact point, fuse breaking, disturbance by the normal function of an overload protection device.
  - Proper starting power is not given to the compressor.

## HAND OVER

Teach the customer the operation and maintenance procedures, using the operation manual. (air filter cleaning, temperature control, etc.)

**CAUTION :**

The connecting cable connected to the indoor and outdoor unit should be complied with the following specifications (This equipment shall be provided with a cord set complying with the national regulation).

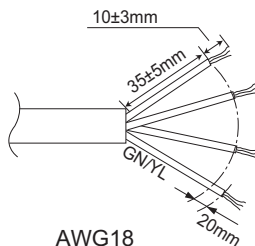

If the supply cord is damaged, it must be replaced by a special cord or assembly available from the manufacturer of its service agent.

◆ **Precautions when laying power and ground wiring**

Use round pressure terminals for connections to the power terminal block. When laying ground wiring, you must use round pressure terminals.

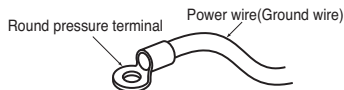

When none are available, follow the instructions below.

- Do not connect wiring of different thicknesses to the power terminal block. (Slack in the power wiring may cause abnormal heat.)
- When connecting wiring which is the same thickness, do as shown in the figure below.

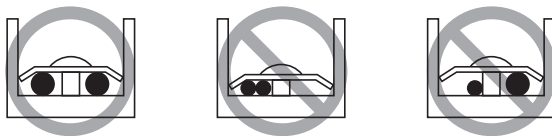

- For wiring, use the designated power wire and connect firmly, then secure to prevent outside pressure being exerted on the terminal block.
- Use an appropriate screwdriver for tightening the terminal screws. A screwdriver with a small head will strip the head and make proper tightening impossible.
- Over-tightening the terminal screws may break them.

## Plumbing materials and storage methods

Pipe must be able to obtain the specified thickness and should be used with low impurities.

Also when handling storage, pipe must be careful to prevent a fracture, deformity and wound.

Should not be mixed with contaminations such as dust, moisture.

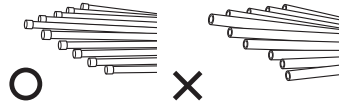

## Refrigerant piping on three principles

	Drying Should be no moisture inside	Cleanliness No dust inside.	Airtight There is no refrigerant leakage
Items			
Cause failure	<ul style="list-style-type: none"> <li>- Significant hydrolysis of refrigerant oil</li> <li>- Degradation of refrigerant oil</li> <li>- Poor insulation of the compressor</li> <li>- Do not cold and warm</li> <li>- Clogging of EEV, Capillary</li> </ul>	<ul style="list-style-type: none"> <li>- Degradation of refrigerant oil</li> <li>- Poor insulation of the compressor</li> <li>- Do not cold and warm</li> <li>- Clogging of EEV, Capillary</li> </ul>	<ul style="list-style-type: none"> <li>- Gas shortages</li> <li>- Degradation of refrigerant oil</li> <li>- Poor insulation of the compressor</li> <li>- Do not cold and warm</li> </ul>
Countermeasure	<ul style="list-style-type: none"> <li>- No moisture in the pipe</li> <li>- Until the connection is completed, the plumbing pipe entrance should be strictly controlled.</li> <li>- Stop plumbing at rainy day.</li> <li>- Pipe entrance should be taken side or bottom.</li> <li>- When removal burr after cutting pipe, pipe entrance should be taken down.</li> <li>- Pipe entrance should be fitted cap when pass through the walls.</li> </ul>	<ul style="list-style-type: none"> <li>- No dust in the pipe.</li> <li>- Until the connection is completed, the plumbing pipe entrance should be strictly controlled.</li> <li>- Pipe entrance should be taken side or bottom.</li> <li>- When removal burr after cutting pipe, pipe entrance should be taken down.</li> <li>- Pipe entrance should be fitted cap when pass through the walls.</li> </ul>	<ul style="list-style-type: none"> <li>- Airtightness test should be.</li> <li>- Brazing operations to comply with standards.</li> <li>- Flare to comply with standards.</li> <li>- Flange connections to comply with standards.</li> </ul>

## Nitrogen substitution method

Welding, as when heating without nitrogen substitution a large amount of the oxide film is formed on the internal piping.

The oxide film is caused by clogging EEV, Capillary, oil hole of accumulator and suction hole of oil pump in compressor. It prevents normal operation of the compressor.

In order to avoid this problem, Welding should be done after replacing air by nitrogen gas.

When welding plumbing pipe, the work is required.

### ◆ How to work

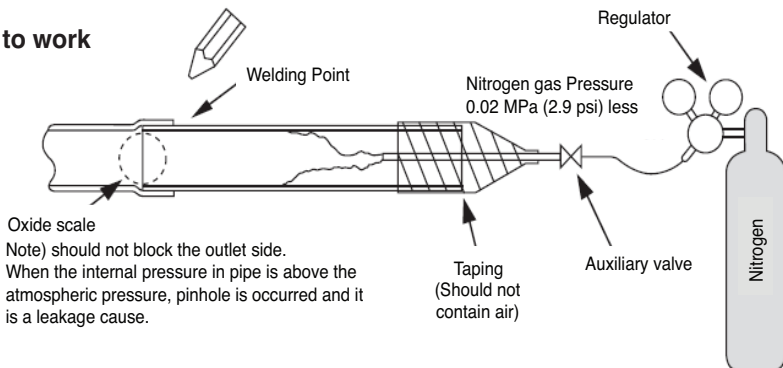

**CAUTION :**

1. Always use the nitrogen.(not use oxygen, carbon dioxide, and a Chevron gas):  
 Please use the following nitrogen pressure 0.02 MPa (2.9 psi)  
 Oxygen ----- Promotes oxidative degradation of refrigerant oil.  
 Because it is flammable, it is strictly prohibited to use  
 Carbon dioxide --- Degrade the drying characteristics of gas  
 Chevron Gas ---- Toxic gas occurs when exposed to direct flame.
2. Always use a pressure reducing valve.
3. Please do not use commercially available antioxidant.  
 The residual material seems to be the oxide scale is observed.  
 In fact, due to the organic acids generated by oxidation of the alcohol contained in the anti-oxidants, ants nest corrosion occurs. (causes of organic acid → alcohol + copper + water + temperature)

**Flaring Work**

Main cause for gas leakage is due to defect of flaring work. Carry out correct flaring work in the following procedure.

**Cut the pipes and the cable**

1. Use the piping kit accessory or the pipes purchased locally.
2. Measure the distance between the indoor and the outdoor unit.
3. Cut the pipes a little longer than measured distance.
4. Cut the cable 1.5m longer than the pipe length.

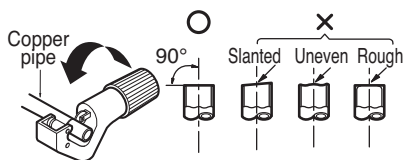

**Burrs removal**

1. Completely remove all burrs from the cut cross section of pipe/tube.
2. While removing burrs put the end of the copper tube/pipe in a downward direction while removing burrs location is also changed in order to avoid dropping burrs into the tubing.

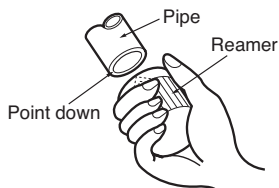

**Putting nut on**

- Remove flare nuts attached to indoor and outdoor unit, then put them on pipe/tube having completed burr removal. (not possible to put them on after finishing flare work)

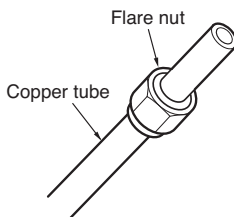

**Flaring work**

1. Firmly hold copper pipe in a bar with the dimension shown in below table table below.
2. Carry out flaring work with the flaring tool.

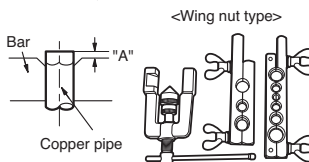

Pipe diameter Inch (mm)	inch (mm)	
	Wing nut type	Clutch type
Ø1/4 (Ø6.35)	0.04~0.07 (1.1~1.8)	0~0.02 (0~0.5)
Ø3/8 (Ø9.52)		
Ø1/2 (Ø12.7)		
Ø5/8 (Ø15.88)		

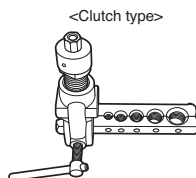



## Installation of Decoration Panel

The decoration panel has its installation direction.

Before installing the decoration panel, always remove the paper template.

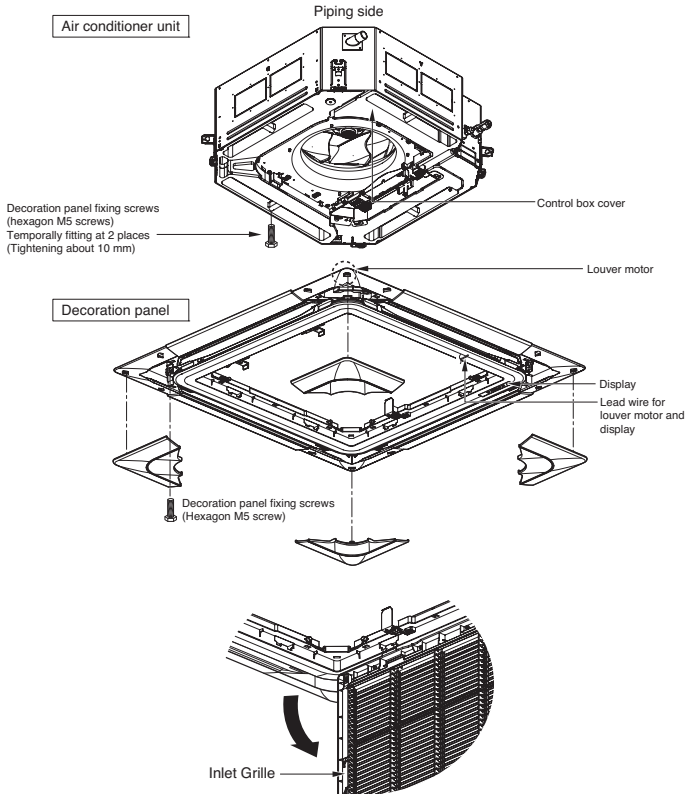
1. Temporarily fix two decoration panel fixing screws (hexagon M5 screw) on the unit body. (Tighten by amount 10mm(3/8 inch) in length.  
The fixing screws (hexagon M5 screw) are included the indoor unit box.
2. Remove the air inlet grille from the decoration panel. (Remove the hook for the air inlet grille cord.)
3. Hook the decoration panel key hole (  ) on the screws fixed in step above, and slide the panel so that the screws reach the key hole edge.
4. Retighten completely two temporarily fixed screws and other two screws. (Total 4 screws)
5. Connect the louver motor connector and display connector.
6. After tightening these screws, install the air inlet grille (including the air filter).



**CAUTION : Install certainly the decoration panel. Cool air leakage causes sweating.  Water drops fall.**

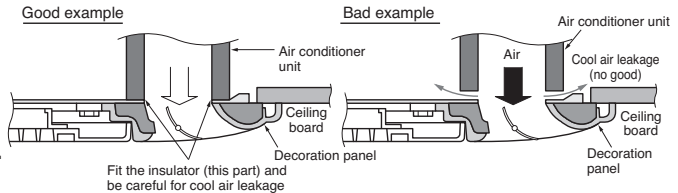

## Drain Piping

- Drain piping must have down-slope (1/50 to 1/100): be sure not to provide up-and-down slope to prevent reversal flow.
- During drain piping connection, be careful not to exert extra force on the drain port on the indoor unit.
- The outside diameter of the drain connection on the indoor unit is 32 mm(1-1/4 inch).

Piping material: Polyvinyl chloride pipe inner diametes  $\varnothing$  25 mm(1 inch) and pipe fittings

- Be sure to install heat insulation on the drain piping.

Heat insulation material: Polyethylene foam with thickness more than 8 mm(5/16 inch).

### Drain test

The air conditioner uses a drain pump to drain water. Use the following procedure to test the drain pump operation:

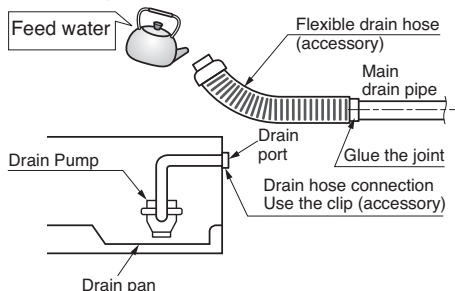

**CAUTION : The supplied flexible drain hose should not be curved, neither screwed. The curved or screwed hose may cause a leakage of water.**

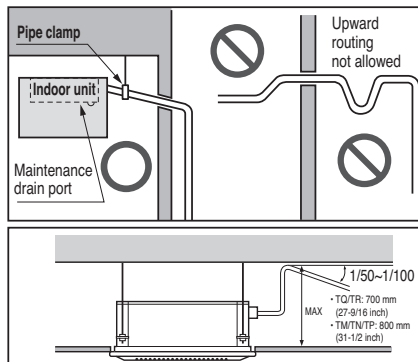

- Connect the main drain pipe to the exterior and leave it provisionally until the test comes to an end.
- Feed water to the flexible drain hose and check the piping for leakage.
- Be sure to check the drain pump for normal operating and noise when electrical wiring is complete.
- When the test is complete, connect the flexible drain hose to the drain port on the indoor unit.

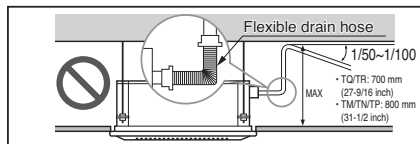

**Attention**

1. Possible drain-head height is up to 700 mm (27-9/16 inch). So, it must be installed below 700 mm (27-9/16 inch).
2. Keep the drain hose downward up to 1/50~1/100 inclination.  
Prevent any upward flow or reverse flow in any part.
3. 5 mm (3/16 inch) or thicker formed thermal insulator is provided for the drain pipe.
4. Upward routing is not allowed.
5. Be sure to check the drain pump for normal operation and abnormal noise when electrical wiring is complete.

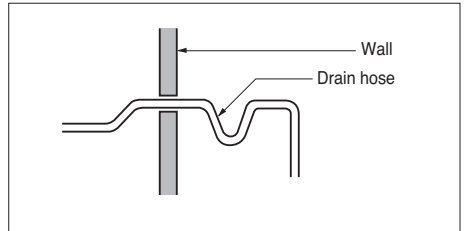
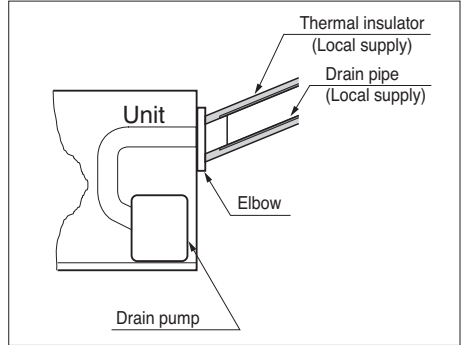
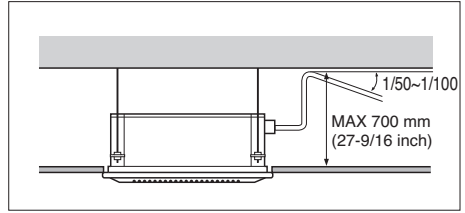

**Ceiling Height Selection**

The ceiling type indoor unit is available to adjust indoor airflow rate by installer setting of the wired remote controller for better service. Please select the height level from the below table.

<Ceiling Height Selection Table>

Ceiling Height		Selection Level	Description
1.6~8.3 kW (5.5~28 kBTu)	10.0~14.5 kW (36~48 kBTu)		
Up to 2.3 m (Up to 7.5 ft)	Up to 2.7 m (Up to 8.9 ft)	Low	Decrease the indoor airflow rate 1 step from standard level
Above 2.3 m, up to 2.7 m (Above 7.5 ft, up to 8.9 ft)	Above 2.7 m, up to 3.2 m (Above 8.9 ft, up to 10.5 ft)	Standard	Set the indoor airflow rate as standard level
Above 2.7 m, up to 3.1 m (Above 8.9 ft, up to 10.2 ft)	Above 3.2 m, up to 3.6 m (Above 10.5 ft, up to 11.8 ft)	High	Increase indoor airflow rate 1 step from standard level
Above 3.1 m, up to 3.6 m (Above 10.2 ft, up to 11.8 ft)	Above 3.6 m, up to 4.2 m (Above 11.8 ft, up to 13.8 ft)	Super high	Increase indoor airflow rate 2 steps from standard level

Ceiling height of 'Very high' function may not exist depending on the indoor unit.  
For the details, refer to the product manual.

## DIP Switch Setting

### 1. Indoor Unit

	Function	Description	Setting Off	Setting On	Default
SW1	Communication	N/A (Default)	-	-	Off
SW2	Cycle	N/A (Default)	-	-	Off
SW3	Group Control	Selection of Master or Slave	Master	Slave	Off
SW4	Dry Contact Mode	Selection of Dry Contact Mode	Wired/Wireless remote controller Selection of Manual or Auto operation Mode	Auto	Off
SW5	Installation	Fan continuous operation	Continuous operation Removal	-	Off
SW6	Heater linkage	N/A	-	-	Off
SW7	Ventilator linkage	Selection of Ventilator linkage	Linkage Removal	Working	Off
	Vane selection (Console)	Selection of up/down side Vane	Up side + Down side Vane	Up side Vane Only	
	Region selection	Selection tropical region	General model	Tropical model	
SW8	Etc.	Spare	-	-	Off

### ⚠ CAUTION

For Multi V Models, DIP switch 1, 2, 6, 8 must be set OFF.

### 2. Outdoor Unit

In case that the products meet specific conditions, "Auto addressing" function can start automatically with the improved speed by turning the DIP switch #3 of the outdoor unit and resetting the power.

\* Specific conditions:

- All names of the indoor units are ARNU\*\*\*\*4.
- The serial number of Multi V super IV (outdoor units) is after October 2013.

DIP switch 7 segment



Outdoor Unit PCB

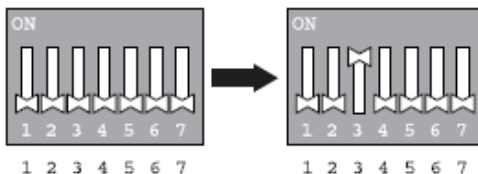

Outdoor Unit DIP Switch

## Group Control Setting

### ⚠ CAUTION

If you want to use the two setpoint function, you should be installed the both new thermostat and 4 series products.

\* Model name of wired remote controller called New thermostat : PREMTB10U

### 1. Group Control 1

#### ■ Wired remote controller 1 + Standard Indoor Units

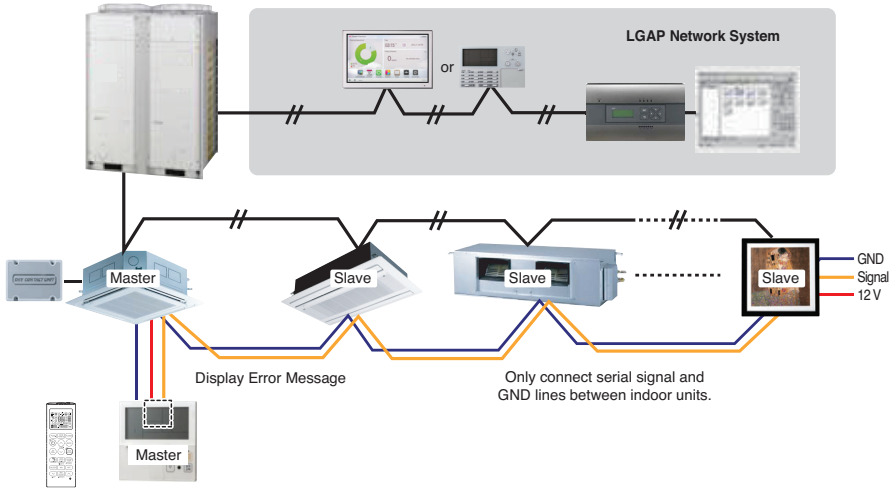

#### ■ DIP Switch in PCB

##### ① Master Setting - No. 3 Off

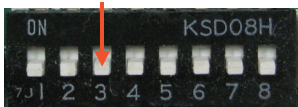

##### ② Slave Setting - No. 3 On

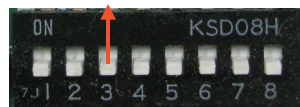

Indoor Unit DIP Switch

Some products have no DIP switch on PCB. It is possible to set indoor units to Master or Slave by using the wireless remote controller instead of DIP switch.

For the details of the setting, please refer to the manual of the wireless remote controller.

1. It is possible to 16 indoor units(Max.) by one wired remote controller.  
Set only one indoor unit to Master, set the others to Slave.
2. It is possible to connect with every type of indoor units.
3. It is possible to use wireless remote controller at the same time.
4. It is possible to connect with Dry Contact and Central controller at the same time.  
- The Master indoor unit is possible to recognize Dry Contact and Central Controller only.
5. In case that any error occurs at indoor unit, the error code is displayed on the wired remote controller.  
It is possible to control the other indoor units except the error units.

- \* It is possible to connect indoor units since Feb. 2009.
- \* It can be the cause of malfunctions when there is no setting of master and slave.

- \* In case of Group Control, it is possible to use following functions.
  - Selection of operation, stop or mode
  - Temperature setting and room temperature check
  - Current time change
  - Control of flow rate (High/Middle/Low)
  - Reservation settings
 It is not possible to use some functions.

## 2. Group Control 2

### ■ Wired remote controllers + Standard Indoor Units

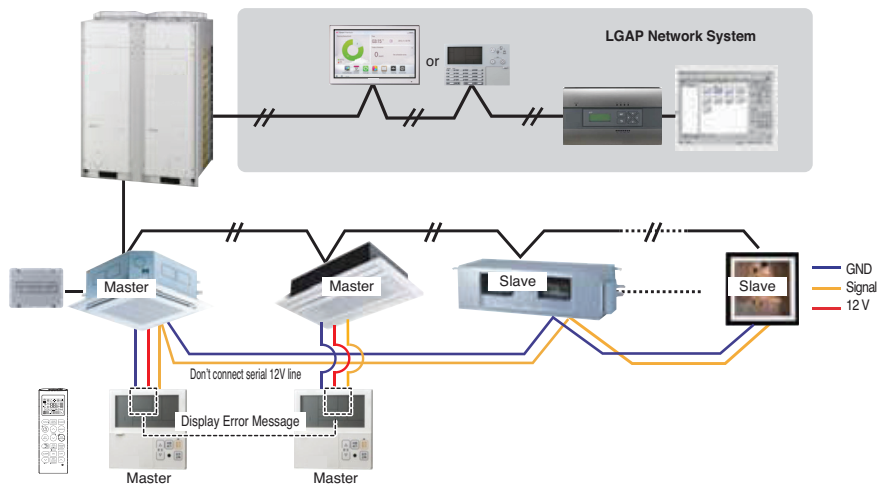

- \* It is possible to control 16 indoor units(Max.) with the master wired remote control.
- \* Other than those, it is same with the Group Control 1.

### 3. Group Control 3

#### ■ Mixture connection with indoor units and Fresh Air Intake Unit

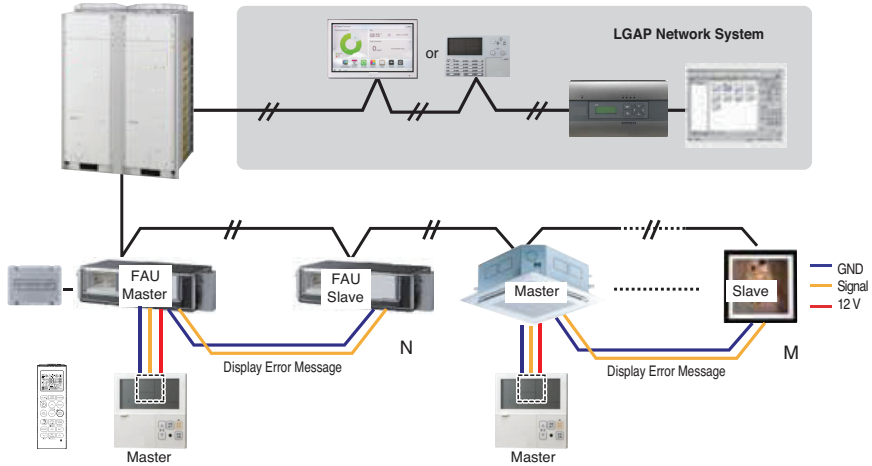

※ In case of connecting with standard indoor unit and Fresh Air Intake Unit, separate Fresh Air Intake Unit with standard units. ( $N, M \leq 16$ ) (Because setting temperature are different.)

※ Other than those, it is same with Group Control 1.



\* FAU : Fresh Air Intake Unit  
Standard: Standard Indoor Unit

## 4. 2 Remote Control

### ■ Wired remote controller 2 + Indoor unit 1

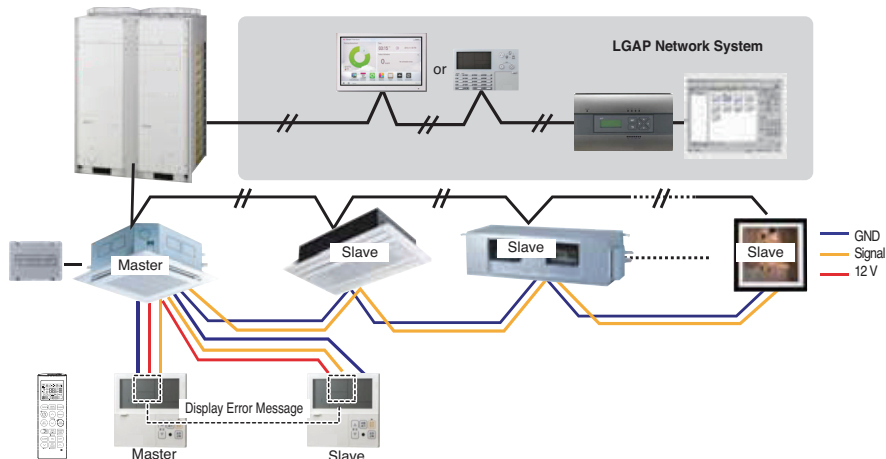

1. It is possible to connect two wired remote controllers (Max.) with one indoor unit.

Set only one indoor unit to Master, set the others to Slave.

Set only one wired remote controller to Master, set the others to Slave.

2. Every types of indoor unit is possible to connect two remote controller.

3. It is possible to use wireless remote controller at the same time.

4. It is possible to connect with Dry Contact and Central controller at the same time.

5. In case that any error occurs at indoor unit, the error code is displayed on the wired remote controller.

6. There isn't limits of indoor unit function.

## 5. Accessories for group control setting

It is possible to set group control by using below accessories.

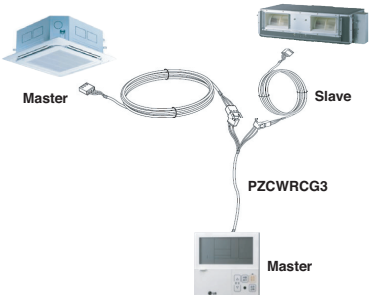
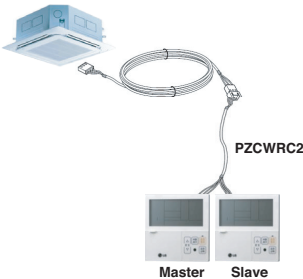
Indoor unit 2 EA +Wired remote controller	Indoor unit 1 EA +Wired remote controller 2 EA
<p>※ PZCWRCG3 cable used for connection</p> 	<p>※ PZCWRC2 cable used for connection</p> 

### ⚠ CAUTION

- Apply totally enclosed noncombustible conduit in case of local building code Requiring plenum cable usage.

## Model Designation

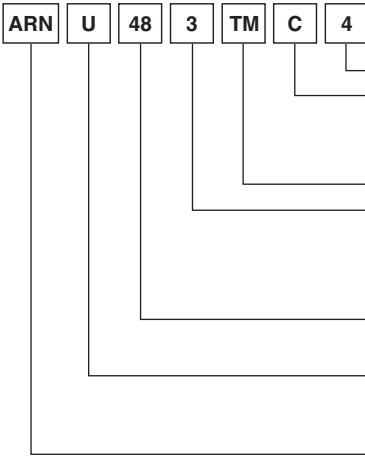

- Serial Number
- Combinations of functions  
A/B: Basic function      L: Neo Plasma(Wall Mounted)  
C/D: Plasma(Ceiling Cassette)
- Chassis Name
- Electrical Ratings  
1:1 Ø, 115 V, 60 Hz                      2:1 Ø, 220 V, 60 Hz  
6:1 Ø, 220 - 240 V, 50 Hz              7:1 Ø, 100 V, 50/60 Hz  
3:1 Ø, 208/230 V, 60 Hz              G:1 Ø, 220 - 240 V, 50 Hz/1 Ø, 220 V, 60 Hz
- Total Cooling Capacity in Btu/h  
EX) 5 000 Btu/h → '05'    18 000 Btu/h → '18'
- Combination of Inverter Type and Cooling Only or Heat Pump  
N: AC Inverter and H/P                  V: AC Inverter and C/O  
U: DC Inverter and H/P and C/O

**MULTI V.** System with Indoor Unit using R410A  
\* LGETA:U Ex) URN

## Airborne Noise Emission

The A-weighted sound pressure emitted by this product is below 70 dB.

\*\* The noise level can vary depending on the site.

The figures quoted are emission level and are not necessarily safe working levels. Whilst there is a correlation between the emission and exposure levels, this cannot be used reliably to determine whether or not further precautions are required. Factors that influence the actual level of exposure of the workforce include the characteristics of the work room and the other sources of noise, i.e. the number of equipment and other adjacent processes and the length of time for which an operator is exposed to the noise. Also, the permissible exposure level can vary from country to country. This information, however, will enable the user of the equipment to make a better evaluation of the hazard and risk.

## Limiting concentration

Limiting concentration is the limit of Freon gas concentration where immediate measures can be taken without hurting human body when refrigerant leaks in the air. The limiting concentration shall be described in the unit of kg/m<sup>3</sup>(lb/ft<sup>3</sup>) (Freon gas weight per unit air volume) for facilitating calculation.

**Limiting concentration: 0.44 kg/m<sup>3</sup>(0.028 lbs/ft<sup>3</sup>)(R410A)**

### ■ Calculate refrigerant concentration

$$\text{Refrigerant concentration} = \frac{\text{Total amount of replenished refrigerant in refrigerant facility (kg(lb(s)))}}{\text{Capacity of smallest room where indoor unit is installed (m}^3\text{(ft}^3\text{))}}$$



US	Please call the installing contractor of your product, as warranty service will be provided by them.
CANADA	Service call Number # : (888) LG Canada, (888) 542-2623 Numéro pour les appels de service : LG Canada, 1-888-542-2623