

OWNER'S MANUAL

AIR CONDITIONER

Please read this manual carefully before operating your set and retain it for future reference.

THERMAV™
(Air-to-Water Heat Pump)

Original instruction

[Representative] LG Electronics Inc. EU Representative : LG Electronics European Shared Service Center B.V. Krijgsman 1, 1186 DM Amstelveen, The Netherlands

[Manufacturer] LG Electronics Inc. Changwon 2nd factory 84, Wanam-ro, Seongsan-gu, Changwon-si, Gyeongsangnam-do, KOREA

For more information, Refer to the CD or LG Web site (www.lg.com).



P/NO : MFL68680902

www.lg.com

ENGLISH

ITALIANO

ESPAÑOL

FRANÇAIS

DEUTSCH

ΕΛΛΗΝΙΚΑ

ČEŠTINA

NEDERLANDS

POLSKI

ROMÂNĂ

TABLE OF CONTENTS

Safety Precautions	3
Product Introduction	8
Owner's Instruction	10
Using Thermostat	27
Maintenance and Service.....	30



FOR YOUR RECORDS

Write the model and serial numbers here:

Model # _____

Serial # _____

You can find them on a label on the side of each unit.

Installer's Name _____

Purchased Date _____

■ Staple your receipt to this page in the event you need it to prove date of purchase or for warranty issues.



READ THIS MANUAL

Inside you will find many helpful hints on how to use and maintain your AWHP properly. Just a little preventive care on your part can save you a great deal of time and money over the life of your product.

You'll find many answers to common problems in the chart of troubleshooting tips. If you review our chart of

Troubleshooting Tips first, you may not need to call for service at all.



PRECAUTION

- Contact the authorized service technician for repair or maintenance of this unit.
- Contact the installer for installation of this unit.
- AWHP is not intended for use by young children or invalids without supervision.
- Young children should be supervised to ensure that they do not play with AWHP.
- When the power cable is to be replaced, replacement work shall be performed by authorized personnel only using only genuine replacement parts.
- Installation work must be performed in accordance with the National Electric Code by qualified and authorized personnel only.

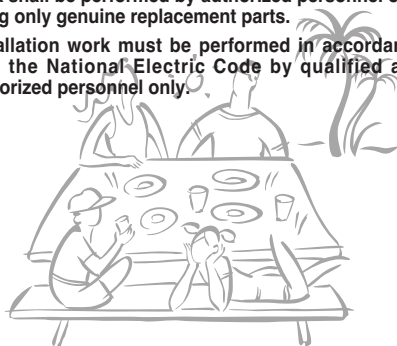

Safety Precautions

To prevent injury to the user or other people and property damage, the following instructions must be followed.

- Incorrect operation due to ignoring instruction will cause harm or damage. The seriousness is classified by the following indications.

⚠ WARNING This symbol indicates the possibility of death or serious injury.

⚠ CAUTION This symbol indicates the possibility of injury or damage.

⚠ WARNING

Always ground the product.

- There is a risk of electric shock.

For electrical work, contact the dealer, seller, a qualified electrician, or an Authorized Service Center. Do not disassemble or repair the product by yourself.

- There is risk of fire or electric shock.

Use the correctly rated breaker or fuse.

- There is risk of fire or electric shock.

Do not use a defective or underrated circuit breaker. Use the correctly rated breaker and fuse.

- There is risk of fire or electric shock .

Always ground the product as per the wiring diagram. Do not connect the ground wire to gas or water pipes lightning rod or telephone ground wire.

- There is risk of fire or electric shock.

Do not modify or extend the power cable. If the power cable or cord has scratches or skin peeled off or deteriorated then it must be replaced.

- There is risk of fire or electric shock.

Do not use a multi outlet. Always use this appliance on a dedicated circuit and breaker.

- There is risk of fire or electric shock.

Install the panel and the cover of control box securely.

- There is risk of fire or electric shock due to dust, water etc.

For installation, removal or reinstall , always contact the dealer or an Authorized Service Center.

- There is risk of fire, electric shock, explosion, or injury.

Do not install the product on a defective installation stand. Be sure that the installation area does not deteriorate with age.

- It may cause product to fall.

Never install the unit on a moving base or a place from where it can fall down.

- The falling unit can cause damage or injury or even death of a person.

When the product is soaked (flooded or submerged) in water, contact an Authorized Service Center for repair before using it again.

- There is risk of fire or electric shock.

Be sure to check the refrigerant to be used. Please read the label on the product.

- Incorrect refrigerant can prevent the normal operation of the unit.

Don't use a power cord, a plug or a loose socket which is damaged.

- Otherwise it may cause a fire or electrical shock.

Do not touch, operate, or repair the product with wet hands.

- There is risk of electric shock or fire.

Do not place a heater or other heating appliances near the power cable.

- There is risk of fire and electric shock.

Do not allow water to run into electric parts. Install the unit away from water sources.

- There is risk of fire, failure of the product, or electric shock.

Do not store or use or even allow flammable gas or combustibles near the product.

- There is risk of fire.

Wiring connections must be secured tightly and the cable should be routed properly so that there is no force pulling the cable from the connection terminals.

- Improper or loose connections can cause heat generation or fire.

Safely dispose off the packing materials. Like screws, nails, batteries, broken things etc after installation or service and then tear away and throw away the plastic packaging bags.

- Children may play with them and cause injury.

Make sure to check that the power device is not dirty, loose or broken and then turn on the power.

- Dirty, loose or broken power device can cause electric shock or fire.

In unit the step-up capacitor supplies high voltage electricity to the electrical components. Be sure to discharge the capacitor completely before conducting the repair work.

- An charged capacitor can cause electrical shock.

When installing the unit, use the installation kit provided with the product.

- Otherwise the unit may fall and cause severe injury.

Be sure to use only those parts which are listed in the service parts list. Never attempt to modify the equipment.

- The use of inappropriate parts can cause an electrical shock, excessive heat generation or fire.

Do not use the product in a tightly closed space for a long time. Perform ventilation regularly.

- Oxygen deficiency could occur and hence harm your health.

Do not open the front cover or grille of the product during operation. (Do not touch the electrostatic filter, if the unit is so equipped.)

- There is risk of physical injury, electric shock, or product failure.

If strange sounds, smell or smoke comes from product, immediately turn the breaker off or disconnect the power supply cable.

- There is risk of electric shock or fire.

Ventilate the product room from time to time when operating it together with a stove, or heating element etc.

- Oxygen deficiency can occur and hence harm your health.

Turn the main power off when cleaning or repairing the product.

- There is risk of electric shock.

Take care to ensure that nobody especially kids could step on or fall onto the unit.

- This could result in personal injury and product damage.

Take care to ensure that power cable could not be pulled out or damaged during operation.

- Almost the antifreeze is a toxic product.

Do not touch any electric part with wet hands. you should be cut power before touching electric part.

- There is risk of electric shock or fire.

Do not touch refrigerant pipe and water pipe or any internal parts while the unit is operating or immediately after operation.

- There is risk of burns or frostbite, personal injury.

If you touch the pipe or internal parts, you should wear protection or wait time to return to normal temperature.

- Otherwise, it may cause burns or frostbite, personal injury.

Do not touch leaked refrigerant directly.

- There is risk of frostbite.

Make sure to install mixing valve (field supply). The mixing valve is setting the water temperature. The hot water temperature maximum values shall be selected according to the applicable legislation.

Do not heated to a temperature of more than provided by the product.

- Otherwise, it may cause fire or damage of product.

⚠ CAUTION

Two or more people must lift and transport the product.

- Avoid personal injury.

Do not install the product where it will be exposed to sea wind (salt spray) directly.

- It may cause corrosion on the product.

Keep level even when installing the product.

- To avoid vibration or noise.

Do not install the product where the noise or hot air from the unit could damage or disturb the neighborhoods.

- It may cause a problem for your neighbors and hence dispute.

Always check for gas (refrigerant) leakage after installation or repair of product.

- Low refrigerant levels may cause failure of product.

Do not use the product for special purposes, such as preserving foods, works of art, etc. It is a consumer AWHP, not a precision refrigeration system.

- There is risk of damage or loss of property.

Do not block the inlet or outlet of air flow.

- It may cause product failure.

Use a soft cloth to clean. Do not use harsh detergents, solvents or splashing water etc .

- There is risk of fire, electric shock, or damage to the plastic parts of the product.

Do not step on or put anything on the product.

- There is risk of personal injury and failure of product.

Do not insert hands or other objects through the air inlet or outlet while the product is operating.

- There are sharp and moving parts that could cause personal injury.

Be cautious when unpacking and installing the product.

- Sharp edges could cause injury.

If the refrigerant gas leaks during the repair, do not touch the leaking refrigerant gas.

- The refrigerant gas can cause frostbite (cold burn).

Do not tilt the unit when removing or uninstalling it.

- The condensed water inside can spill .

Do not mix air or gas other than the specified refrigerant used in the system .

- If air enters the refrigerant system, an excessively high pressure results, causing equipment damage or injury.

If the refrigerant gas leaks during the installation, ventilate the area immediately.

- Otherwise it can be harmful for your health.

Dismantling the unit, treatment of the refrigerant oil and eventual parts should be done in accordance with local and national standards.

Do not expose your skin or kids or plants to the cool or hot air draft.

- This could harm to your health.

Use a firm stool or ladder when cleaning, maintaining or repairing the product at an height.

- Be careful and avoid personal injury.

The hot water may not be available immediately, during disinfection operation or depending on the amount of hot water.

During floor heating operation it is important to limit the minimum/maximum water temperature.

Product Introduction

Typical Installation Scene

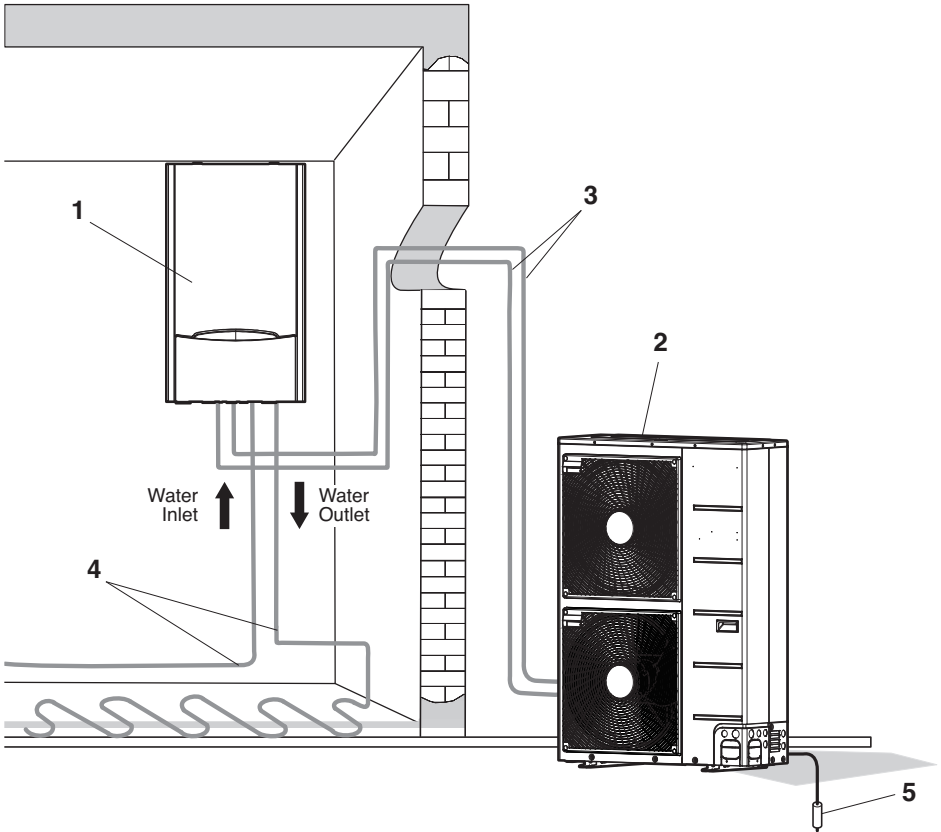

1. Indoor unit
2. Outdoor unit
3. Refrigerant pipe and connecting cable
4. Water pipe
5. Ground wire to ground outdoor unit to prevent electrical shocks.

*The shape of products can be changed according to the model capacity and type.

Remote Controller

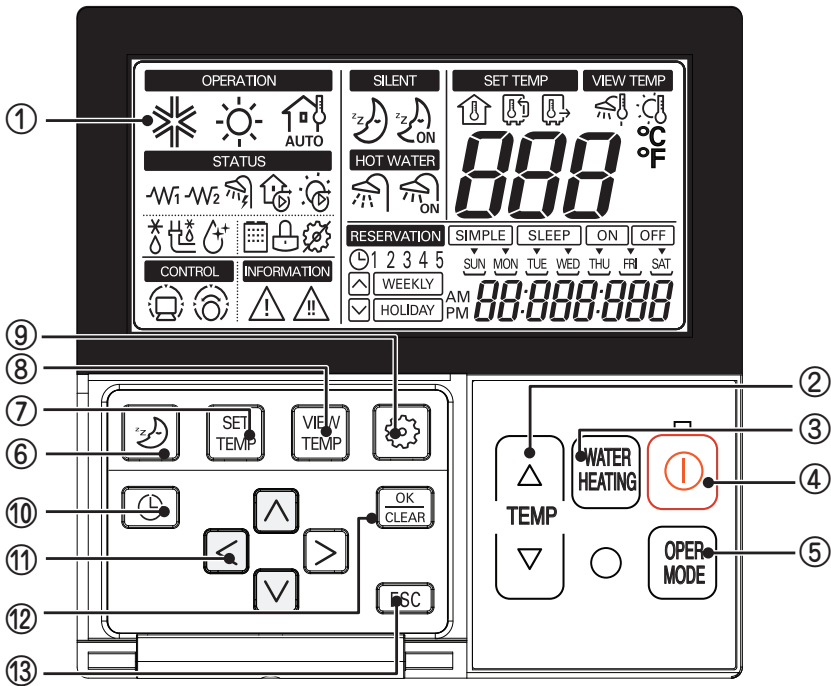

No	Name
1	Display
2	Change Temperature Button
3	Water Heating Enable / Disable Button
4	Power Button
5	Operation Mode Selection Button
6	Silent Mode On / Off Button
7	Temperature Setting Mode Button
8	Temperature View Mode Button
9	Function Setting Button
10	Programming Button
11	Direction Button (Up, Down, Left, Right)
12	Set / Clear button
13	ESC Button

Owner's Instruction

Monitoring Information



Electric heater STEP one



Electric heater STEP two

These icons indicate that the backup electric heater is operating.



Sanitary water tank heater

This icon indicates that sanitary water tank electric heater which is located inside sanitary water tank is active.

The icon is not used when sanitary water tank is not installed.



Water pump

This icon indicates that the water pump inside the unit is active.



Auxiliary solar thermal pump

This icon indicates that auxiliary solar thermal pump is active.

NOTE : As installation of auxiliary solar thermal pump is not compulsory but recommendation according to field condition, this icon can be seen although no auxiliary solar thermal pump is installed.



Defrosting

This icon indicates that the defrost mode is active.

This mode is automatically operating.



Maintain lowest temperature

The purpose of this mode is maintaining the temperature to prevent damage by freezing of water pipe.



Disinfection

This icon indicates disinfecting operation is ongoing in sanitary water tank.



Compressor

This icon indicates that the compressor is active.



Child Lock



No function



Central Controller

This icon indicates that the product is controlled by the central controller.



Thermostat

This icon indicates connection with thermostat.



Slight trouble

This icon indicates that slight trouble is occurred.



Heavy trouble

This icon indicates that heavy trouble is occurred.

Mode Change

Turn on the product and select operation mode.

1 Press power button to turn on the product.



2 Press OPER MODE button to select each operation mode.

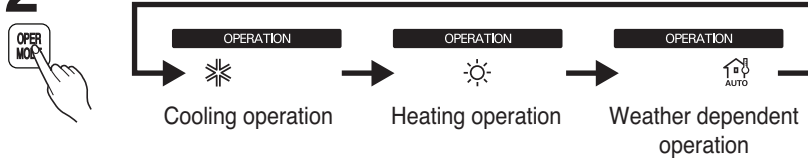

Operation mode

- Cooling operation - The product yields cool water to use in FCU cooling.
- Heating operation - The product yields hot water to use in under floor heating or FCU heating.
- Weather dependent heating operation - In this mode, heating setpoint is automatically determined by pre-defined temperature profile.

Selecting Target Temperature

1 Press SET TEMP button to select each operation mode.

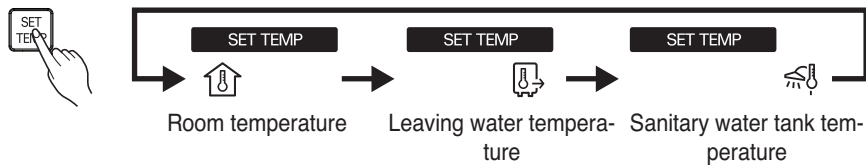

2 Adjust desired temperature by pressing change TEMP buttons on each mode.

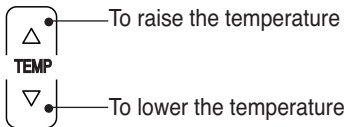

* Note

- ⬆ : Increase 1 °C or 2 °F per one time pressing
- ⬇ : Decrease 1 °C or 2 °F per one time pressing
- We can change the temperature range of each mode on installation setting mode. Please refer function code 11 to 15.
- Room temperature setting is available when remote room air sensor (sold separately) is installed. Please refer function code 03.
- Sanitary water tank temperature setting is available when sanitary water tank is installed.

Sanitary Water Heating Operation

1 Press repeatedly view  button

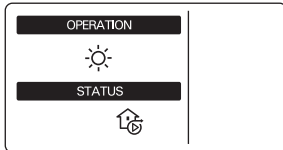

<Sanitary water heating disable>

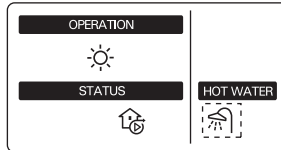

<Sanitary water heating enable>

2 Sanitary water heating operation is operating only on enable condition.
During operation, segment will be on.

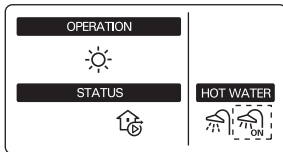





<Sanitary water heating ON>

<Note>

- This function is not used when the sanitary water tank is not installed.
- If you want to know more information, refer function code [15, 26~29] on installation information section.

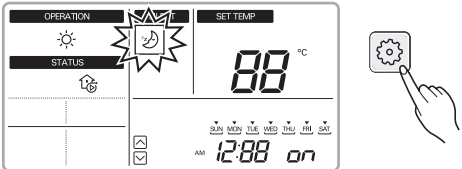
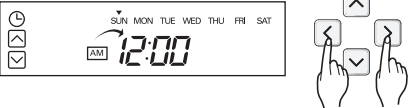
Silent Mode Operation

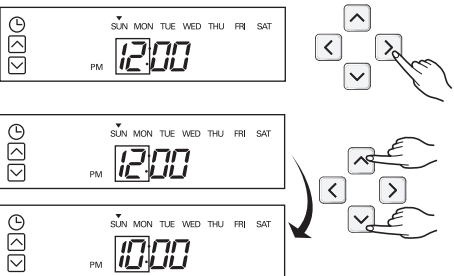
Silent mode operation is that the unit works at reduced capacity so that the noise produced by the unit drops.





<p>1 Press the programming button repeatedly until silent mode icon is shown.</p>	
<p>2 Press left, right button to select menu. "AM/PM or hour"</p>	
<p>3 Press down button to move to AM/PM part and adjust it. (The AM/PM segment will be flashed).</p>	
<p>4 Press right button to move to "Hour" part. (the "Hour" segment will be flashed).</p> <p>5 Press up, down button to adjust the Hour.</p>	
<p>6 If you finish the setting, press OK / CLEAR button.</p>	
<p>7 Press exit button to exit or system will automatically release without any input 25 seconds.</p>	

! This implies that the heating and cooling capacity will also drop. Beware of this when a certain level of heating or cooling is required.

! Silent mode operation may not work while the product is proceeding higher priority operation such as defrost operation, anti-freezing operation, and etc. (When this mode is not operated by the priority order, ONLY display **SILENT** .)

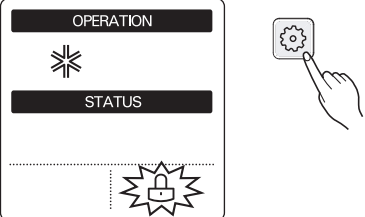
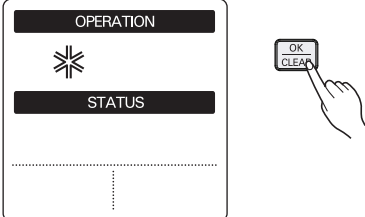
Child Lock

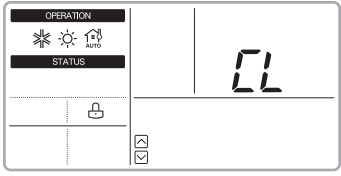
This function is to prevent children or other people from using controller.

<p>1 Press function setting button to enter user setting mode. (The segment will be flashed)</p>	
<p>2 Press OK / CLEAR button to finish the selection. The segment will be disappear.</p>	
<p>3 During Child Lock,  icon and 'CL' will be displayed during 3 seconds whenever entering any kind of buttons except for view temperature button and setting/clear button.</p>	
<p>4 To release this setting, pressing function setting button until  icon flash and then enter OK / CLEAR button.</p>	

Quick Sanitary Tank Heating

If there is urgent sanitary heating demand, Quick Sanitary Tank Heating mode can be used to reduce the time to reach target sanitary tank temperature by forcibly turning on sanitary tank heater. After reaching target sanitary tank temperature or by user's input to stop, Quick Sanitary Tank Heating mode will be finished.

- 1** Press Sanitary Tank Heating Enable button with up button for 3 seconds to start Quick Sanitary Tank Heating. 'Sanitary Tank Heating Enable' icon and 'Sanitary tank heater' icon will be flashing together.

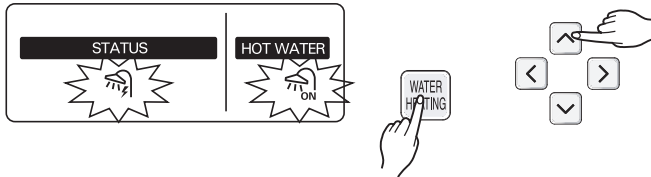

- 2** If target sanitary tank temperature is reached or user pushes Sanitary Tank Heating Enable button with down button for 3 seconds, Quick Sanitary Tank Heating will be finished and icon flashing will be stopped.

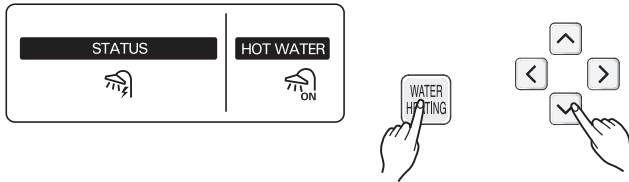

Error Code display

The error code will be displayed on control panel.

Slight trouble : Sensor trouble



Heavy trouble : Compressor cycle trouble





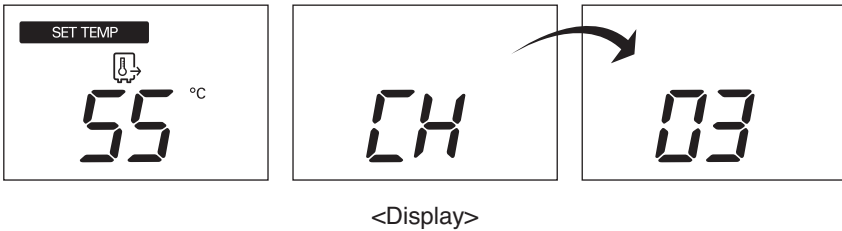

Critical error

On critical error, the unit will stop unconditionally.
At this time, 'CH' and error code No. keep display by turns.

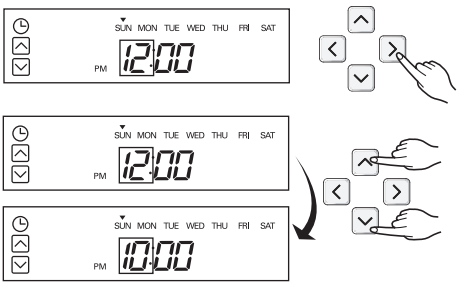
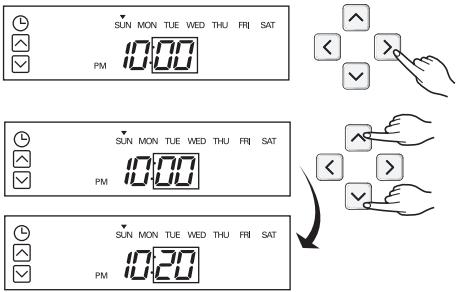

Setting Current Time

You can set current time.

<p>1 Keep pressing programming button for 3 seconds to enter Setting current time mode.</p>	
<p>2 Press left, right button to adjust the current day.</p>	
<p>3 Press down button to move to AM/PM part and adjust it. (The AM/PM segment will be flashed).</p>	
<p>4 Press right button to move to "Hour" part. (the "Hour" segment will be flashed).</p> <p>5 Press up, down button to adjust the Hour.</p>	
<p>6 Press right button to move to "Minute" part. (the "Minute" segment will be flashed).</p> <p>7 Press up, down button to adjust the Minute.</p>	
<p>8 If you finish the setting, press OK / CLEAR button.</p>	
<p>9 Press exit button to exit or system will automatically release without any input 25 seconds.</p>	

Programming : Setting Simple Reservation

You can easily turn-on reservation.(ONLY enable when unit is stand-by.)

<p>1 Press programming button to enter the Programming mode. (the segment flashing)</p>		
<p>2 Press up, down button to adjust the reservation time.</p>		
<p>3 If you finish the setting, press OK / CLEAR button to complete programming.</p>		
<p>4 Press exit button to exit or system will automatically release without any input after 25 seconds.</p>		





Programming : Setting Sleep Reservation

You can easily turn-off(sleep) reservation.(ONLY enable when unit is operating.)

<p>1 Press programming button to enter the Programming mode. Repeat pressing button to select [sleep reservation]. (the segment flashing)</p>		
<p>2 Press up, down button to adjust the reservation time.</p>		
<p>3 If you finish the setting, press OK / CLEAR button to complete programming.</p>		
<p>4 Press exit button to exit or system will automatically release without any input after 25 seconds.</p>		

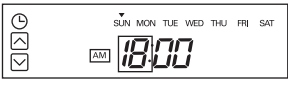
Screed drying

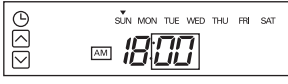
After installing water pipes for under floor heating, user can select screed drying mode for curing the cement

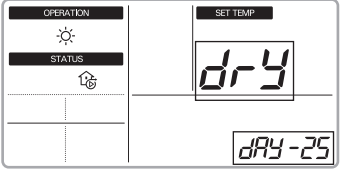
<p>1 Keep pressing programming button for 3 seconds to enter setting screed drying mode.</p>	
<p>2 Press programming button to select function code 18.</p>	
<p>3 Press left, right button to move to screed drying setting part.</p>	
<p>4 Press up, down button to adjust "01" or "00" (00: Not Used 01: Used)</p>	
<p>5 If you finish the setting, press OK / CLEAR button.</p>	
<p>6 Press exit button to exit or system will automatically release without any input 25 seconds.</p>	
<p>7 During the screed drying mode, "dry" is displayed. Left days for completing the screed drying mode are displayed.</p>	 <p>Left days</p>









Programming : Setting ON Reservation

This function is able to turn-on after a setting time.

<p>1 Press programming button to enter the Programming mode. Repeat pressing button to select [on reservation]. (the segment flashing)</p>		
<p>2 Press up, down button to adjust AM/PM.</p>		
<p>3 Press right button to move to "Hour" part. (the "Hour" segment will be flashed).</p>		
<p>4 Press up, down button to adjust the Hour.</p>		
<p>5 Press right button to move "Minute" part. (the "Minute" segment will be flashed).</p>		
<p>6 Press up, down button to adjust the Minute.</p>		
<p>7 If you finish the setting, press OK / CLEAR button to complete programming.</p>		
<p>8 Press exit button to exit or system will automatically release without any input after 25 seconds.</p>		

Programming : Setting OFF Reservation

This function is able to turn-off after a setting time.

<p>1 Press programming button to enter the Programming mode. Repeat pressing button to select [off reservation]. (the segment flashing)</p>	
<p>2 Press up, down button to adjust AM/PM.</p>	
<p>3 Press right button to move to "Hour" part. (the "Hour" segment will be flashed).</p>	
<p>4 Press up, down button to adjust the Hour.</p>	
<p>5 Press right button to move "Minute" part. (the "Minute" segment will be flashed).</p>	
<p>6 Press up, down button to adjust the Minute.</p>	
<p>7 If you finish the setting, press OK / CLEAR button to complete programming.</p>	
<p>8 Press exit button to exit or system will automatically release without any input after 25 seconds.</p>	

Programming : Weekly Reservation

The weekly reservation is active after setting current time.

<p>1 Press programming button to enter the Programming mode. Repeat pressing button to select [Weekly reservation]. (the segment flashing)</p>		
<p>2 Press left, right button to adjust the current day.</p>		
<p>3 Press up, down button to adjust the action number.</p>		
<p>4 Press right button to move to "Hour" part on ON time section. (The "Hour" segment will be flashed).</p>		
<p>Start Time Section</p>		
<p>5 Press up, down button to adjust the Hour on Start Time section.</p>		
<p>6 Press right button to move to "Minute" part on start time section. (The "Minute" segment will be flashed).</p>		
<p>7 Press up, down button to adjust the minute on start time section.</p>		
<p>8 Press right button to move to "Hour" part on OFF time section. (The "Hour" segment will be flashed).</p>		
<p>Off Time Section</p>		

9 Please refer the process from No.5 to No.7 for setting OFF time. It is same method.

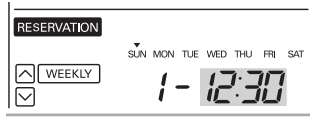

10 If you finish the setting, press setting/cancel button to complete programming. The under bar segment will be created, when it finished.

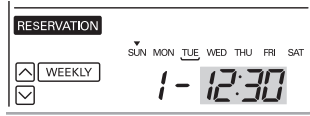

11 Please refer the process from No.2 to No.10 for setting other day weekly program. It is same method.

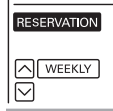

12 Press exit button to exit or system will automatically release without any input after 25 seconds.



<Note>

Description of weekly reservation

<Start time selection>

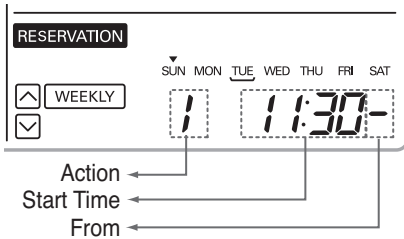

<Start time selection>

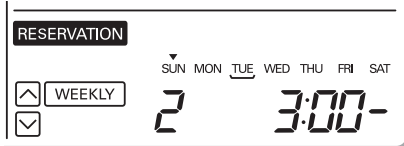

<Off time selection>

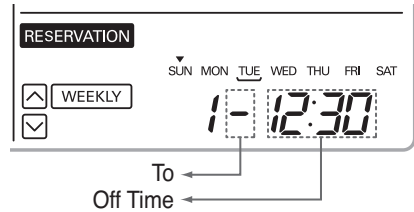

<Off time selection>

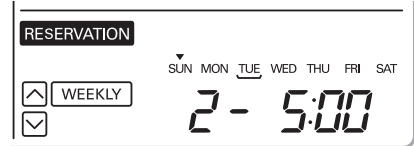

* Two actions per weekday can be programmed, in total 14 actions.

Programming : Holiday Reservation

This function is to automatically stop the machine working on some days.

<p>1 Press programming button to enter the Programming mode. Repeat pressing button to select [Holiday reservation]. (the segment flashing)</p>		
<p>2 Press left, right button to adjust the holiday.</p>		
<p>3 When you press set/clear button after finishing the selection, the day selected will be disappear.</p>		
<p>4 Press exit button to exit or system will automatically release without any input after 25 seconds.</p>		

Programming : Sanitary Tank Heating & Sanitary Tank Heater Operation

This function is schedule programming about sanitary tank heating and sanitary tank heater operation. Two schedule programming for sanitary tank heating and another Two schedule programming for sanitary tank heater operation are possible. Pre-assigned program numbers for sanitary tank heating programming are '1' and '2'. Programming number '3' and '4' are assigned for sanitary tank heater operation. Scheduled programming will be operated everyday.

- 1** Press programming button to enter the programming mode. Repeat pressing button to select sanitary tank heating programming. (the segment flashing)

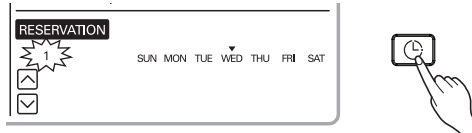

- 2** Press left and right button to adjust schedule program number. Programming number '1' and '2' are for sanitary tank heating programming(if selected, 'Sanitary tank heating enabled' icon will be flashing), and '3' and '4' are for sanitary tank heater operation programming(if selected, 'Sanitary tank heater' icon will be flashing).

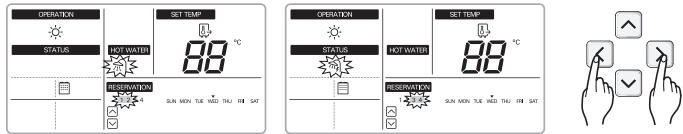

- 3** After selecting programming number, press down button to enter adjusting turn-on time. Turn-on time can be adjusted by pressing left, right, up, and down button. After assigning minute of turn-on time, press right button to enter adjusting turn-off time. Like adjusting turn-on time, press left, right, up, and down button to change turn-off time.

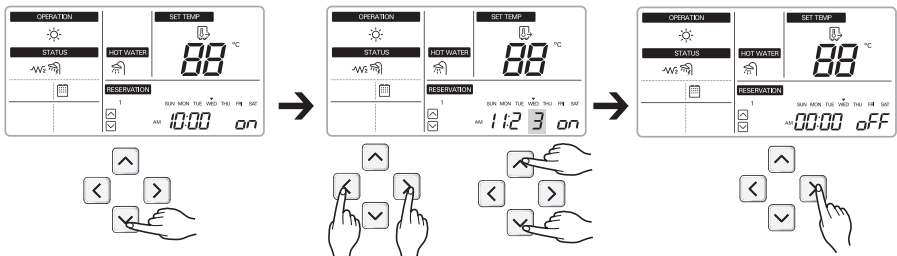

- 4** Press set button to finish programming. To exit Programming mode, press ESC button.

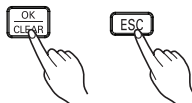

Using Thermostat

The term "thermostat", which is widely used in this chapter, is a kind of 3rd party accessory. LG Electronics does not supply thermostat and it should be supplied 3rd party manufacturers. Room thermostat can be used for easy and convenience control. To utilize thermostat more efficiently and correctly, this chapter presents information about using thermostat.

⚠ CAUTION





1. Some electro-mechanical type thermostat has internal delay time to protect compressor. In that case, mode change can take time more than user's expectation. Please read thermostat manual carefully if the product does not response quickly.
2. Setting temperature range by thermostat can be different with that of the product. The heating or cooling set temperature should be chosen within the setting temperature range of the product.

How to use Thermostat

To find how to turn on and off, how to set target temperature, how to change operating mode, etc, please refer thermostat operating manual provided by thermostat manufacturer.



Operating Thermostat with Control Panel

• Following features are permitted when thermostat is installed. :

-  SET TEMP button
-  VIEW TEMP button
-  Temperature adjust button*
-  Sanitary water heating Enable / Disable
-  Silent operation On / Off

* : Adjusted temperature is only used to control electric heater on / off condition.
The product does not turn on / off according to the setting temperature at the control panel.
It turns on / off according to the thermostat signal.

• Following features are NOT permitted when thermostat is installed. :

-  Operating mode (cooling) selection
-  Time scheduling
-  Operation On / Off

Emergency Operation

• Definition of terms

- Trouble : a problem which can stop system operation, and can be resumed temporarily under limited operation without certificated professional's assist.
- Error : problem which can stop system operation, and can be resumed ONLY after certificated professional's check.
- Emergency mode : temporary heating operation while system met trouble.

• Objective of introducing 'Trouble'

- Not like airconditioning product, Air-to-Water heat pump is generally operation in whole winter season without any system stopping.
- If system found some problem, which is not critical to system operating for yielding heating energy, the system can temporarily continue in emergency mode operation with end user's decision.

• Classified trouble





- Trouble is classified two levels according to the seriousness of the problem. : Slight trouble and Heavy trouble
- Slight trouble : Sensor trouble. In most case, this trouble is concerned with sensor problems. The unit is operating under emergency mode operation(level 1).
- Heavy trouble : Compressor cycle trouble. Emergency mode operation(level 2) is performed by optional electric heater.
- Option trouble : a problem is found for option operation such as water tank heating. In this trouble, the troubled option is assumed as if it is not installed at the system.

• Emergency operation level

- When system met trouble, it stops operation and wait for user's decision : Calling service center or starting emergency operation.
 - To start emergency operation, user simply push ON / OFF button once more.
 - Two different levels are prepared for emergency operation : High temperature cycle and low temperature cycle.
 - In emergency operation mode, user can not adjust target temperature.
- ※ It can not be operated, if the electric heater accessory is not installed.

	Dip Switch (#4)	Target Leaving Water Temperature	Target Room Air Temperature	Target Sanitary Water Temperature
High temperature cycle	OFF	50°C	24°C	70°C
Low temperature cycle	ON	30°C	19°C	50°C

• **Following features are permitted in emergency operation. :**



-  Operation On / Off
-  VIEW TEMP button*
-  Temperature adjust button*
-  Sanitary water heating Enable / Disable

* : Temperature measured by failed sensor is displayed as ' - '.

* : Adjusted temperature is only used to control electric heater on / off condition.

The product does not turn on / off according to the setting temperature at the control panel. It turns on / off according to the thermostat signal.

• **Following features are NOT permitted in emergency operation. :**

-  Operating mode (cooling/ heating/ weather-dependent) selection
-  Time scheduling
-  SET TEMP button

• **Duplicated trouble : Option trouble with slight or heavy trouble**

- If option trouble is occurred with slight (or heavy) trouble at the same time, the system puts higher priority to slight (or heavy) trouble and operates as if slight (or heavy) trouble is occurred.
- Therefore, sometimes sanitary water heating can be impossible in emergency operation mode.
When sanitary water is not warming up while emergency operation, please check if sanitary water sensor and related wiring are all Ok.

• **Emergency operation is not automatically restarted after main electricity power is reset.**

- In normal condition, the product operating information is restored and automatically restarted after main electricity power is reset.
- But in emergency operation, automatic re-start is prohibited to protect the product.
- Therefore, user must restart the product after power reset when emergency operation has been running.

Maintenance and Service

Maintenance Activities

In order to ensure optimal availability of the unit, a number of checks and inspections on the unit and the field wiring have to be carried out at regular intervals, preferably yearly. This maintenance should be carried out by your local agreed technician.

When the unit is not going....

⚠ CAUTION

- If the product is not used for long time, we strongly recommend **NOT TO SWITCH OFF THE POWER SUPPLY** to the product.
- If power is not supplied, some special product-protecting actions (such as water pump anti-locking) will not performed.

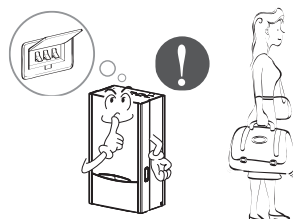

Call the service immediately in the following situations

1. Anything abnormal such as burning smell, loud noise etc. happen. Stop the unit and turn the breaker off. Never try to repair by yourself or restart the system in such cases.
2. Main power cord is too hot or damaged.
3. Error code is generated by self diagnosis.
4. Water leaks from unit.
5. Any switch, breaker (safety, earth) or fuse fails to work properly.

User must carry routine checkup & cleaning to avoid unit's poor performance.

In case of special situation, the job must be carried out by the only service person.

⚠ CAUTION

- In the case of water with added brine, the drain valve of shut-off valve must be connected to a recovery container.
- Do not touch the water stirred with the brine.
- When the brine in the pipe is leaked, do not operate the unit and contact dealer, seller or an authorized service center.

Troubleshooting Tips! Save Time and Money!

Check the following points before requesting repairs or service.... If the malfunction persists, please contact your dealer.

Case	Explanation
AWHP does not operate.	<ul style="list-style-type: none"> • Have you made a mistake in timer operation? • Has the fuse blown or has the circuit breaker been tripped? • If 'CH 14' is displayed in the display panel, check whether the water pipe is frost or remove the air in the PHEX by opening the air vent.
The room has a peculiar odor.	<ul style="list-style-type: none"> • Check that this is not a damp smell exuded by the walls, carpet, furniture or cloth items in the room.
AWHP does not operate for about 3 minutes when restart.	<ul style="list-style-type: none"> • This is the protector of the mechanism. • Wait about three minutes and operation will begin.
Does not cool or heat effectively.	<ul style="list-style-type: none"> • The room may have been very hot when the AWHP was first turned on. Allow time for it to cool down. • Has the setting temperature been set incorrectly?
The unit operation is noisy.	<ul style="list-style-type: none"> • Refrigerant flow sound <ul style="list-style-type: none"> - While the system is being started or stopping, sound from the refrigerant flow may be heard. • Water noise <ul style="list-style-type: none"> - During starting or stopping of the unit, noise can appear in water piping. • During defrost <ul style="list-style-type: none"> - Noise can appear in unit due to defrosting of water. • Sound for the unit heat exchanger <ul style="list-style-type: none"> - During the cooling operation, a sound may be heard from the indoor unit heat exchanger due to water freezing or melting.
Steam is raised in unit.	<ul style="list-style-type: none"> • Steam from heat exchanger <ul style="list-style-type: none"> - During defrosting operation, ice on the heat exchanger is melted, resulting in making steam.
Control panel display is faint, or no display at all.	<ul style="list-style-type: none"> • Has the circuit breaker been tripped?

